

Wireless Acoustic Signal Transmitter User Manual



**XYR 5000 Line
34-XY-25-03
Rev. 2
06/04**

Wireless Acoustic Signal Transmitter Models WN571

Versions 1.57 or later



Important Information to the User



- Changes or modifications not expressly approved by the manufacturer may void the user's authority to operate the equipment.
- This device complies with Part 15 of the FCC Rules. Operation is subject to the following two conditions: 1) this device may not cause harmful interference, and 2) this device must accept any interference received, including interference that may cause undesired operation.
- This device is for mobile and fixed use only (not portable or body-worn). A separation distance of 20cm must be maintained at all times between the antenna and the body of the user and bodies of nearby persons.
- If the Wireless Management Toolkit (RF Server) software is shutdown, the RS-485 network **MUST be physically disconnected** from the PC as the serial port is no longer being controlled by the software and may disrupt communications between the Base Radio(s) and Analog/Digital Output Module(s).
- This device has been designed to operate with an antenna having a maximum gain of 9 dBd. Antenna having a higher gain is strictly prohibited per regulations of Industry Canada. The required antenna impedance is 50 ohms.
- To reduce potential radio interference to other users, the antenna type and its gain should be so chosen that the equivalent isotropically radiated power (EIRP) is not more than that required for successful communication.
- The installer of this radio equipment must ensure that the antenna is located or pointed such that it does not emit RF field in excess of Health Canada limits for the general population; consult Safety Code 6, obtainable from Health Canada's website www.hc-sc.gc.ca/rpb.



FCC Certification



- This product is a frequency hopping RF transceiver module for the 900MHz ISM band, designed to meet FCC 15.247, and is used in industrial control and monitoring applications.
- The antenna is factory installed and **MUST NOT** be removed or modified by user.

Honeywell Inc.
Industrial Measurement and Control
2500 West Union Hills Drive
Phoenix, AZ 85027

Copyright 2004 by Honeywell International Inc.
Rev. 2- 06/28/2004

While this information is presented in good faith and believed to be accurate, Honeywell disclaims the implied warranties of merchantability and fitness for a particular purpose and makes no express warranties except as may be stated in its written agreement with and for its customers.

In no event is Honeywell liable to anyone for any indirect, special or consequential damages. The information and specifications in this document are subject to change without notice.

Honeywell® and TotalPlant® are U.S. registered trademarks Of Honeywell International Inc.

Other brand or product names are trademarks of their respective owners.

About This Document

Revision Notes

The following list provides notes concerning all revisions of this document.

Doc ID	Rel ID	Date	Notes
34-XY-25-03	Rlse. 0	12/03	1st issue of document.
34-XY-25-03	Rev. 1	02/04	2nd issue of document.
34-XY-25-03	Rev. 2	06/04	Reformatted layout, updated technical information.

Contacts

World Wide Web

The following lists Honeywell's World Wide Web sites that will be of interest to our industrial automation and control customers.

Honeywell Organization	WWW Address (URL/e-mail)
Corporate	http://www.honeywell.com
Industrial Measurement and Control	http://content.honeywell.com/imc/
International	http://www.honeywell.com/Business/global.asp
Field Instruments	http://www.honeywell.com/imc
Technical Assistance Center	ACE@Honeywell.com (e-mail)

Telephone

Contact us by telephone at the numbers listed below.

	Organization	Phone Number
United States and Canada	Honeywell Inc.	1-800-343-0228
	Industrial Automation and Control	1-800-525-7439
	Global Technical Support Center	1-800-423-9883
Asia Pacific	Honeywell Asia Pacific Inc. Hong Kong	(852) 8298298
Europe	Honeywell PACE Brussels, Belgium	[32-2] 728-2111
Latin America	Honeywell Inc. Sunrise, Florida U.S.A.	(305) 364-2355

Table of Contents

Section 1: Introduction	1
1.1: Using This Manual	1
1.2: About the Device	2
1.3: Unpacking	2
1.4: Software Compatibility	2
Section 2: In a Hurry?	3
Section 3: Installation	4
3.1: Mechanical Installation	4
3.1.1: Transmitter Positioning	4
3.1.2: Simple RF Placement Procedure	5
Section 4: General Configuration	7
4.1: Transmitter Displayed Messages	7
4.1.1: The Read-Only Sequence	7
4.2: Overall Configuration Menu Map	8
4.3: Setting the Transmitter Tag Name	8
4.4: Setting a User Password	9
4.5: Resetting All Transmitter Settings	9
Section 5: Configuring the RF Communications	10
5.1: RF Channel Selection	10
5.2: RF Baud Rate Selection	10
5.3: RF Identification Selection	11
Section 6: Configuring the Sampling and Transmission Rates	12
6.1: Selecting the Normal Transmission Rate	12
6.2: Selecting the Normal Sampling Rate	13
6.3: Selecting the Abnormal Transmission Rate	14
6.4: Selecting the Abnormal Sampling Rate	15
6.6: Selecting the Normal Upper and Lower Values	16
6.7: Selecting Rates, Thresholds, and Deadbands via the Software	17
Section 7: Maintaining the Transmitter	18
7.1: Changing the Battery	18
Section 8: Technical Specifications	19
Dimensioned Mechanical Drawing	20
Intrinsic Safety Control Drawing	21
Appendix A: Navigating the Menus	22
Appendix B: Displayed Message Definitions	23
Appendix C: Transmitter Menu Map	24

Table of Figures

3.1: Example of Incorrect Transmitter Positioning	4
3.2: Menu Map to RSSI Mode	5
4.1: Transmitter Power-UP and Operations Sequence.....	7
4.2: The Read-Only Sequence	7
4.3: Overall Configuration Menu Map	8
4.4: Menu Map to Tag Name Setting	8
4.5: Menu Map to Password Setting.....	9
4.6: Password Setting Using Wireless Management Toolkit	9
5.1: Menu Map to RF Channel Setting.....	10
5.2: Menu Map to Baud Rate Setting	10
5.3: Menu Map to RF ID Setting.....	11
6.1: Menu Map to Normal Transmission Rate Setting.....	12
6.2: Incorrect Sampling Rate	13
6.3: Correct Sampling Rate	13
6.4: Menu Map to Normal Sampling Rate Setting	13
6.5: Example of Abnormal Transmission Rate Setting	14
6.6: Menu Map to Abnormal Transmission Rate Setting.....	14
6.7: Example of Abnormal Sampling Rate Setting	15
6.8: Menu Map to Field Abnormal Sampling Rate Setting.....	15
6.9: Normal Upper and Lower Value Example	16
6.10: Menu Map to Normal Upper and Lower Value Settings	16
6.11: Condition “Chatter” Without Time Deadband	16
6.12: Condition “Chatter” Elimination Due to Time Deadband	16
6.13: Sampling and Transmission Rate Selection Using the Software	17
6.14: Normal Upper and Lower Value Selection Using the Software	17
Dimensioned Mechanical Drawing	21
Intrinsic Safety Control Drawing	22

Section 1: Introduction

1.1: USING THIS MANUAL

This manual is designed to assist in installing, operating, and maintaining Honeywell Model WN571 Acoustic Signal Transmitters. The manual is broken into sections as follows:

Section 2: In a Hurry?

This section summarizes what must be done in order to get the device installed, configured and in operation quickly. However, it does not provide detailed or how-to information to perform the tasks outlined.

Section 3: Installation

This section explains mechanical installation considerations; such as Transmitter placement and Transmitter Mounting.

Section 4: General Configuration

In this section general configuration options such as password protection, and selecting a user password are discussed. Also covered, is the setting of a Transmitter tag name, resetting of all Transmitter settings, and a discussion of the various messages that are displayed on the Transmitter LCD.

Section 5: Configuring the RF Communications

This section covers the setup of the Transmitter RF Communications which allow the Transmitter to achieve communication with the Base Radio. Parameters discussed are the Transmitter RF ID, the RF channel setting and Baud Rate.

Section 6: Configuring the Sampling and Transmission Rates

This section aids the user in selecting the amount of time between each sample of the process, and the time between each transmission of this sample to the Base Radio. Also discussed is the use of setting an abnormal threshold in which sampling and transmission times may change during a period when the process variable is within the abnormal region.

Section 7: Maintaining the Transmitter

This section explains how the Transmitter should be cared for once it has been placed into service. Changing the battery is also covered in this section.

Section 8: Technical Specifications

This section explains the technical specifications that are associated with this device such as power characteristics, accuracy, and operating characteristics.

1.2: ABOUT THE DEVICE

The Honeywell Acoustic Signal Transmitter is a reliable Radio Frequency (RF) transceiver coupled with an ultrasound sensor that can be used to monitor a variety of processes in hazardous and hard-to-reach areas. The time and expense of running wires often makes it difficult to measure parameters that have an economic impact on your plant operation, but the Acoustic Signal Transmitter allows you to quickly and accurately monitor those devices at fraction of the cost, which gives you bigger and faster returns on your instrumentation investments.

The Transmitters communicate in a secure, digital protocol over a band of frequencies from 902MHz to 928MHz. This data communication technique has been the backbone of the military's secure communications protocols for many years. These devices require no wires, permits or licenses, and they are easily set up and installed right out of the box.

You can use this device for long term monitoring in remote locations, for short-term data gathering on process conditions, or to quickly test the economic viability of a new installation.

The purpose of this manual is to help you install and maintain your Honeywell Acoustic Signal Transmitter. BEFORE setting up and installing the Transmitter please setup and configure the Base Radio.

1.3: UNPACKING

Remove the Packing List and check off the actual equipment received. If you have any questions on your shipment, please call your Honeywell Representative. Upon receipt of shipment, inspect the container for any signs of damage in transit. Especially take note of any evidence of rough handling. Report any apparent damage immediately to the shipping agent.

Please note that sometimes units are assembled with accessories when shipped. Inspect the shipment carefully if you think that something is missing. This is rare, as we take considerable care to pack units for shipment, but it does sometimes happen. Please give us a call and we may be able to resolve this matter quickly over the phone.

NOTE

Please note that the carrier will not honor any claims for damage unless all shipping materials are saved for their examination. If damage is found during examining and removal of the contents, save the packing material and the carton.

1.4: SOFTWARE COMPATABILITY

Software for Honeywell is revised periodically. Internal device software may contain portions that are not compatible with previous versions of the Wireless Management Toolkit software.

To ensure software compatibility, Wireless Management Toolkit software version 1.56.126 or later must be used. If you believe you are experiencing software compatibility issues please call Honeywell Technical Support at 800-423-9883 or email ACE@Honeywell.com.

Section 2: In a Hurry?

This section summarizes what must be done in order to get the device installed, configured and in operation quickly. However, it does not provide detailed or how-to information to perform the tasks outlined.



1. Place the Transmitter in the desired location of operation.
2. Turn on Transmitter by pressing ENTER and NEXT buttons simultaneously and holding until unit powers up.
3. Set RF CHAN setting equal to the Base Radio's RF Channel.
4. Set BAUD RT setting equal to the Base Radio's Baud Rate.
5. Set RF ID number to be a unique value between 1 and 50.
6. Select normal transmission rate.
7. Select normal sampling rate.
8. Select abnormal transmission rate.
9. Select abnormal sampling rate.
10. Set normal upper and lower values.
11. Select engineering measurement units.

If the "RF OFF" message is being displayed on the Transmitter LCD, perform the following:

- Set the Set RF CHAN setting equal to the Base Radio's RF Channel.

If a "NO RF" message is being displayed on the Transmitter LCD, check the following:

- Is the Transmitter set to the above listed configurations?
- Is the Base Radio on?
- Are the Transmitter and Base Radio set to the matching configurations? (See Section 5 of Transmitter and Base Radio User Manuals)
- Are the Base Radio and Transmitters unable to communicate due to obstructions or distance? (See Transmitter Manual: Transmitter Placement section)
- Did you perform the Simple RF Placement Procedure? (See Transmitter Guide: A Simple RF Placement Procedure section)

 Caution 
If the Base Radio is not energized for more than 30 minutes, the Transmitters should also be turned off to preserve battery life. Leaving the Transmitters on when the Base Radio is not energized or out of range will cause the Transmitters to transmit very frequently and drastically reduces their battery life.

Section 3: Installation

3.1: Mechanical Installation

In this section mechanical installation instructions are discussed for the various setup capabilities of the Acoustic Signal Transmitter. The subsections are as follows:

3.1.1: Transmitter Positioning

3.1.2: A Simple RF Placement Procedure

The Honeywell Acoustic Signal Transmitter is a rugged device, but it provide much better performance if installed with careful consideration, as noted in this manual. It may be utilized in any ultrasound measurement service so long as care is exercised to prevent exposing the sensing elements to excess stress or temperature. Installation practices have a lot to do with these service parameters and the life that you can expect from your Honeywell Acoustic Signal Transmitter. The main considerations for installation are covered below.

Give careful consideration to the environment where you will be installing your instrument. Avoid installations that expose the device to excess temperature, high vibration, considerable shock, or exposure to dripping condensate or corrosive materials. Also avoid installing the device in an un-serviceable location.

Most often these problems can be avoided with some thought at the time of installation. The practices noted below are generally recommended, but they can only act as a guideline and cannot cover all possible variations. The final installation must be made at the discretion and approval of the user. You must be the judge of the actual installation.

Dimensioned mechanical drawings for aid in mechanical installation are located in Section 8: Technical Specifications

⚠ **Warning** ⚠

During installation do not apply force to the instrument housing or antenna. Use a proper wrench for all installations. Failure to use correct installation procedures can cause damage to the Base Radio.

3.1.1: Transmitter Positioning

Correct positioning of the Transmitter will ensure the best performance of the device. When planning the positioning of the Transmitters there are a few parameters that must be paid attention to:

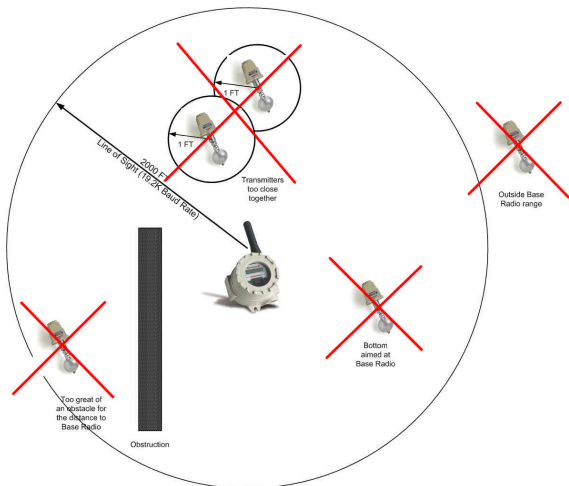

- Ideally the top of the Transmitter will generally point in an upward fashion. The bottom of the Transmitter should NOT point directly at the Base Radio and the Transmitter LCD should point away from the Base Radio.
- All Transmitters should maintain an approximate spacing of at least one foot apart from one another.
- The line of sight range between a Transmitter and Base Radio is 2000 feet at the 19.2K baud rate setting. Note that this range is reduced by the amount of RF Noise present, obstructions, and the material properties of the obstruction.
- Only place the Transmitter in ambient operating temperatures of -40°F to 185°F (-40°C to 85°C).

Figure 3.1: Examples of Incorrect Transmitter Positioning

Figure 3.1, shown to the left, gives examples of incorrect setups according to the previously mentioned parameters.

Because there are so many setup possibilities we cannot cover them all. A correct setup would make sure that the above warnings are heeded, and that the Transmitter and Base Radio are capable of communication. The RF Placement Test section will help you to determine if you have a selected the correct installation points and orientations for your application.

3.1.2: A Simple RF Placement Procedure

Remember, proper placement of the Transmitter will optimize your RF communication range and capabilities. Perhaps the best test to perform before mechanically mounting the unit is a quick hand-held test.

To perform this test you should have a good idea of where the Base Radio will be placed (for more information see Section 3 of the Base Radio User Manual). Put the Base Radio in this area and power it up. Make sure that the Base Radio and Transmitter are on the same RF Channel and Baud Rate (See Section 5). You may also have to increment the number of Transmitters with which the Base Radio is communicating (See the Base Radio User Manual Section 4.3).

Once both the Base Radio and Transmitter are set up to be on the same network, make sure communication is established by looking at the Transmitter LCD for the 'RF OK' message in the Read-Only Sequence (see Section 4.1.1).

After communications have been established, Transmitter should be placed in RSSI Diagnostic mode to determine the signal strength at the location of the equipment to be monitored. Placing the Transmitter in this mode is explained in the following section.

3.1.2.1: Transmitter RSSI Diagnostic

The Received Signal Strength Indicator (RSSI), located in the Transmitter's diagnostic menu, displays the RF signal strength in one of seven ranges. The signal strength is displayed on the LCD using a combination of '>' and '_' characters. Full signal strength is displayed as ">>>>>>>" while minimum signal strength is displayed as "> _ _ _ _ _". If the Transmitter is not communicating with the Base Radio (i.e. NO RF), all underscore characters will be displayed ("_ _ _ _ _").

The RSSI is measured every time the Transmitter receives a message from the Base Radio. The signal strength of the received message from the Base Radio is calculated during this time. The actual signal strength in dBm for each range is shown below:

>	>	>	>	>	>	>
Less than	Between	Between	Between	Between	Between	Greater than
-105 dBm	-105 dBm & -100 dBm	-100 dBm & -95 dBm	-95 dBm & -90 dBm	-90 dBm & -85 dBm	-85 dBm & -80 dBm	-80 dBm

To place the Transmitter in RSSI Diagnostic mode follow the menu map shown on the following page in Figure 3.2. Note that the RSSI menu is under the DIAGNSE menu and not the CONFIG menu.

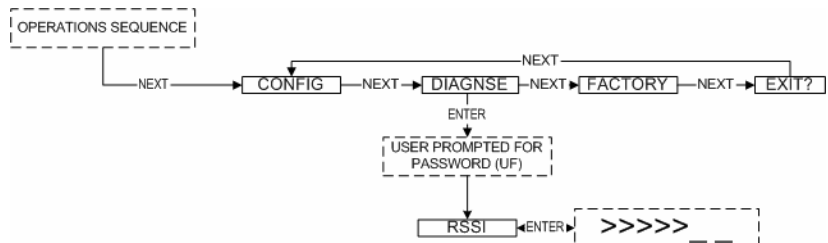

Figure 3.2: Menu Map to RSSI Mode

3.1.2.1 Continued

Now that the Transmitter is in the RSSI mode, bring the Transmitter close to the equipment you wish to monitor. Look at the LCD; notice the '>' will constantly fluctuate. One should estimate an average value based on these fluctuations. While the ideal signal integrity is seven arrows, the suggested fluctuating arrow ranges for the different RF Baud Rate settings are listed below:

- 4.8K Baud – between 1 and 4 arrows
- 19.2K Baud – between 2 and 5 arrows
- 76.8K Baud – between 3 and 6 arrows

Once you have verified that you are receiving a signal, you should check to make sure the Transmitter is communicating properly with the Base Radio. To do so exit the RSSI by pressing ENTER, and then navigate to the EXIT? of the diagnostic menu and return to the Operations Sequence shown in Figure 1 on page 8. Once in the Operations Sequence, you will notice small arrows on the rightmost and leftmost regions of the LCD. These arrows indicate the sending and receiving of messages between the Base Radio and the Transmitter. If both arrows are moving up and down, and you do not see a NO RF message, then the position you have selected will be suitable for mounting the device.

If only one or neither of the arrows is moving, and you see a NO RF message, then you do not have satisfactory RF communication with the Base Radio. If your application allows, move the Transmitter to a different position and check again for communications. If your application only allows you to mount at this particular point, you may want to try a slower baud rate setting for an increased range (see note).

NOTE

While using slower baud rate increases communication distance, it also requires more time to complete a communications cycle. This may not be suitable for your application.

One final solution is to reposition the Base Radio. However, this may affect communications with previously installed Transmitters, and if so, may require the use of a second Base Radio for your application. To select a better spot for the Base Radio, see section 3.1.1 of the Base Radio User Manual.

Section 4: General Configuration

This section discusses the generalities for configuring the Transmitter via the NEXT and ENTER buttons. The subsections are as follows:

- 4.1: Transmitter Displayed Messages
 - 4.1.1: The Read-Only Sequence
- 4.2: The Overall Configuration Menu Map
- 4.3: Setting a Transmitter Tag Name
- 4.4: Setting a User Password
- 4.5: Resetting All Transmitter Settings

4.1: Transmitter Displayed Messages

NOTE
 During configuration and testing, keep Transmitters at least one foot apart and away from the Base Radio to ensure good communications.

To turn the Transmitter on, press both the NEXT and ENTER buttons and hold them for a few seconds. Upon power up, the Transmitter will display the Power-Up Sequence, and then go into the Operations Sequence. These Sequences are shown in Figure 4.1 below:

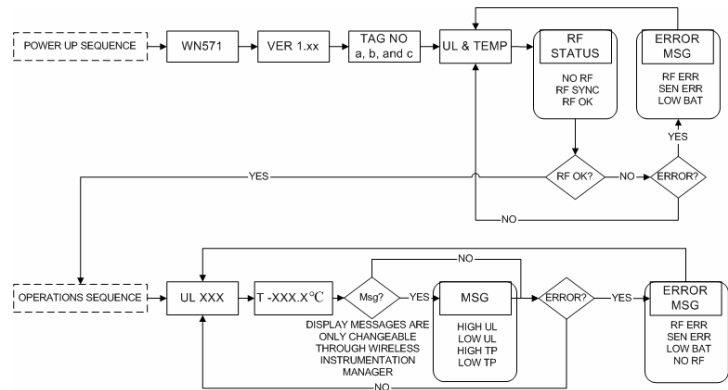
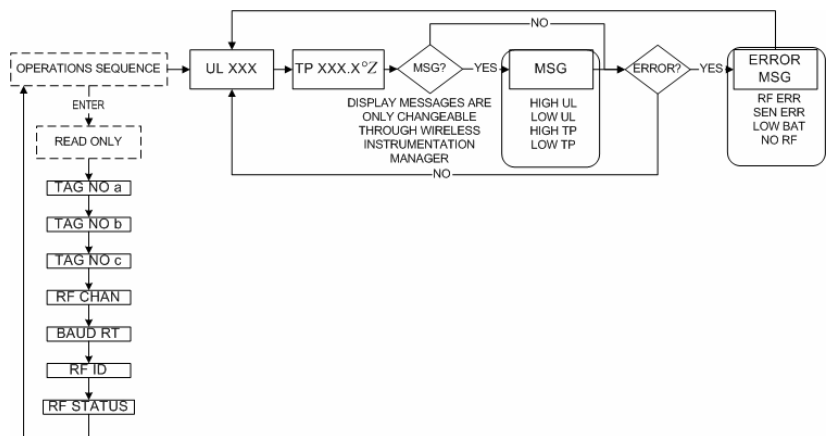

Figure 4.1: Transmitter Power-Up and Operations LCD Sequences

4.1.1: The Read-Only Sequence

Once the Transmitter is in the Operations Sequence, a user may access the READ-ONLY Sequence without a password by simply pressing the ENTER button at any time. The Read-Only Sequence, as shown in Figure 4.2, displays extra information about the current settings of the Transmitter that are not seen during the Operations Sequence, but does not allow any changes to be made to these settings.



4.2: The Read-Only Sequence

4.4: Setting a User Password*

Each Transmitter has a password that will lock out undesired users from making changes to the Base Radio. Any user may still view some of the Transmitter settings by pressing the ENTER key during the Operations Sequence and viewing the Read-Only Sequence.

The password is a four-digit password The factory default is 0000. If you wish to select a different password, follow the Transmitter Menu Map shown in Figure 4.5 to change it.

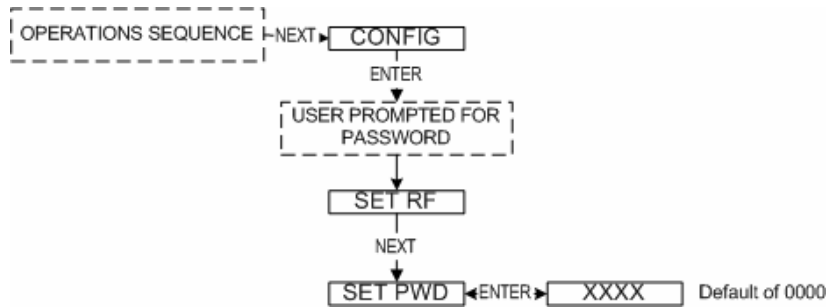

Figure 4.5: Menu Map to Password Setting

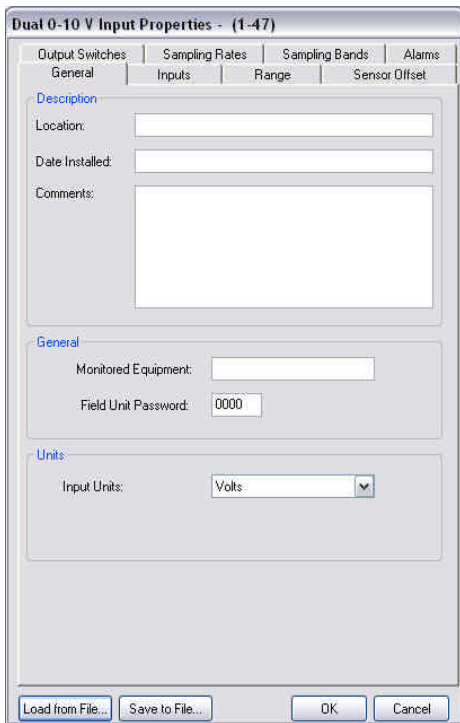

Figure 4.6: Password Setting Using Wireless Management Toolkit

If you have the Wireless Management Toolkit software this menu option will not be accessible via the Transmitter once the Transmitter detects that the software is being used (See Appendix A for more details). The password should be entered using the Wireless Management Toolkit software. To do so, enter the configuration menu (See Section 9.2 of the Wireless Management Toolkit User Manual). Once in the configuration menu click on the **General** tab to bring up the general information as shown in Figure 4.6.

The Transmitter password for this device can be set by entering a four-digit number in the **Transmitter Password** field. Once a password has been entered, click **OK** to save and download the password to the Transmitter.

Please note that the password only protects the Transmitter from unauthorized configuration via the NEXT and ENTER buttons. The Wireless Management Toolkit requires a user login password to gain access to all configuration parameters. However, user accounts are available and can be set with different access levels and restrictions (For more information on user accounts see the Wireless Management Toolkit User Manual Section 8.4).

4.5: Resetting All Transmitter Settings

To reset all Transmitter settings to their default state, the user must navigate to the DEFAULT menu option in the CONFIG menu via the keypad.

Once at the default menu option pressing the ENTER button will display 'RESET?' on the LCD; which asks if the user is sure he or she wants to reset the device to its default configuration. The user will then be prompted with 'NO' on the LCD. Pressing the ENTER button while 'NO' is being displayed will NOT reset the device. Pressing the NEXT button will display 'YES' on the LCD. If the user presses the ENTER button while 'YES' is being displayed the device will be reset.

* Indicates that Menu is Disabled if Wireless Management Toolkit is detected. (See Appendix A)

Section 5: Configuring the RF Communications

Caution

If the Base Radio is not energized for more than 30 minutes, the Transmitters should also be turned off to preserve battery life. Leaving the Transmitters on when the Base Radio is not energized or out of range will cause the Transmitters to transmit very frequently and drastically reduces their battery life.

5.1: RF Channel Selection

NOTE

The RF Channel defines a set of frequencies on which communication takes place between the Base Radio and the Transmitter. Each RF Channel has a different set of frequencies, thus allowing the user to have multiple different wireless networks co-existing throughout the same facility.

The RF Channel can be thought of as a set of walkie-talkies. If both walkie-talkies are on channel one they can communicate. If a walkie-talkie is on channel one and the other is on channel two, they cannot communicate. Likewise, if two walkie-talkies are on channel one and two other walkie-talkies are on channel two, the walkie-talkies on channel one cannot hear what is being transmitted by the walkie-talkies on channel two.

5.2: Baud Rate Selection

NOTE

If you change the baud rate of a Transmitter, you must also change the baud rate of the Base Radio and all other Transmitters that are communicating with that Base Radio to match.

In order for the Transmitter and the Base Radio to communicate, they must be on the same RF Channel and must be transmitting at the same Baud Rate. While all Transmitters and Base Radios are set to default configurations at the factory, if any configuration differences are present the Base Radio will not be able to communicate with the Transmitters. The subsections are as follows:

- 5.1: RF Channel Setup
- 5.2: RF Baud Rate Setup
- 5.3: RF Identification Setup

All Base Radios and Transmitters can be set to one of 16 different communication channels. The only Transmitters recognized by a particular Base Radio are the units that are on the same RF Channel as that Base Radio. This allows the user to decide which Transmitters communicate with each Base Radio.

Each Transmitter comes from the factory set to the RF OFF channel. This means the Transmitter will not communicate to any Base Radio. To set the Transmitter for communication first determine the channel that you wish to use. Then follow the Transmitter menu map shown below in Figure 5.1 to configure the RF Channel.

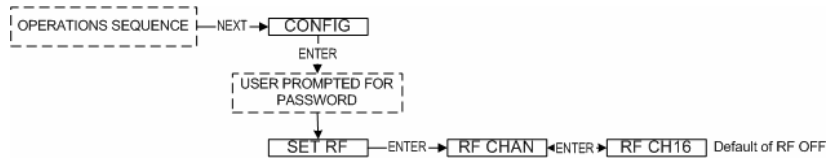

Figure 5.1: Menu Map to RF Channel Setting

Once you are in the RF Channel menu, you can increment it by pressing the next button. When selecting this value, do not choose an RF Channel that is currently being used by other Honeywell Wireless Systems as this can cause communication problems.

The RF Baud Rate refers to the speed at which the Base Radio and Transmitters communicate. There are three selectable settings with the fastest update times and ranges listed below:

- 4.8K– Rate of 4.8 Kbaud (Update every 20 seconds)
- Range of 3000ft (Line of Sight)
- 19.2K– Rate of 19.2 Kbaud (Update every 5 seconds)
- Range of 2000ft to 2500ft (Line of Sight)
- 76.8K– Rate of 76.8 Kbaud (Update every 1 second)
- Range of 500ft to 750ft (Line of Sight)

A faster RF Baud Rate allows the user to transmit more information in a given period of time, but it will also limit the Transmitter’s range. If you need more distance out of your Transmitters or are encountering difficulties by frequently losing communications, then select a slower baud rate.

Follow the Base Radio menu map shown in Figure 5.2 to configure the RF Baud Rate. The factory default is the 19.2K Baud Rate.

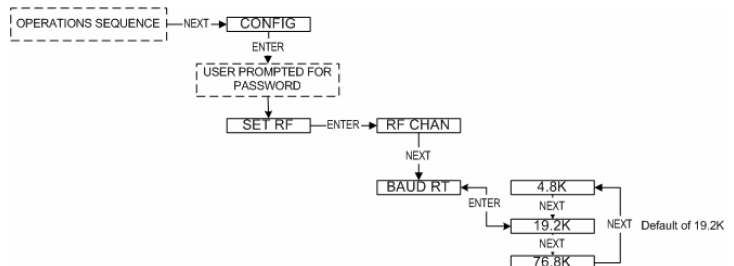

Figure 5.2: Menu Map to Baud Rate Setting

5.3: RF Identification Selection

Each Transmitter is identified by the Base Radio and software according to the RF Identification (ID) given to that particular unit. Two Transmitters CANNOT have the same ID and be on the same RF Channel (if you do not know the RF Channel see section 5.1). If the Transmitter is in the Operations Sequence, pressing the ENTER button displays the Read-Only Sequence on the LCD, which displays the ID of that unit like this: ID 3.

All Transmitters in your system are set to a default ID number upon shipment. For example, if you have ordered a Base Radio and three Transmitters, the Transmitters will be configured to ID's 0, 0 and 0. You must set these units to three different IDs between 1 and 50. The Transmitters in this example could be set to RF IDs 1, 2 and 3.

First determine the ID's you'd like to give each unit. Then follow the menu map shown in Figure 5.3 to configure the RF ID. The factory default is RF ID 0, which disables the RF communication of the unit.

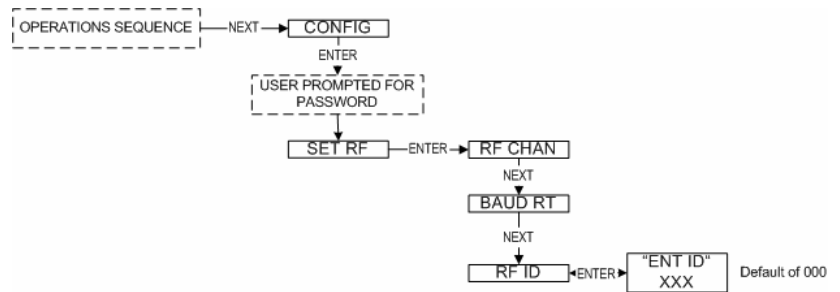

Figure 5.3: Menu Map to RF ID Setting

Once you have selected the RF ID you wish to use for this particular Transmitter, save and exit the menus and return to the Operations Sequence.

The Transmitter should now be successfully configured to the Base Radio. To check this, press ENTER while the Transmitter is in the Operations Sequence for the Read-Only Sequence to be displayed. You may see an RF SYNC message displayed on the Transmitter LCD. This means that the Transmitter and Base Radio are attempting to synchronize communications. If this is successful the RF Status will display an RF OK message. If this is unsuccessful the RF Status will display a NO RF message.

Also notice the two small arrows on either side of the LCD; if they are fluctuating up and down, that indicates the Transmitter and Base Radio are successfully communicating. If only one or none of the arrows are moving then RF communication is unsuccessful.

Section 6: Configuring the Sampling and Transmission Rates

The Acoustic Signal Transmitter is very versatile with many programmable features and can be used in numerous different applications. Because no two applications are the same, some configuration is required for each unit. This section will walk you through the initial configuration of these sample and transmit settings. The subsections are as follows:

- 6.1: Selecting the Normal Transmission Rate
- 6.2: Selecting the Normal Sampling Rate
- 6.3: Selecting the Abnormal Transmission Rate
- 6.4: Selecting the Abnormal Sampling Rate
- 6.5: Setting the Smart Rate Threshold
- 6.6: Selecting the Normal Upper and Lower Values
- 6.7: Selecting Rates, Thresholds, and Deadbands via the Software

6.1: Selecting the Normal Transmission Rate*

The Transmitter is in a “sleep” mode to save power during the operations sequence. This mode turns off most of the electronics on the unit, with the exception of the LCD, in order to preserve battery life. The Transmitter will then ‘wake up’ every **Normal Sampling Period** and take the necessary current/voltage readings. The Transmitter will then transmit these readings to the Base Radio on an interval determined by the **Normal Transmission Rate**.

Notice that the fastest update rate of the Normal Transmission Rate is dependent on the baud rate setting you selected earlier (see section 5.2). The transmission rates cannot update data faster than their communication speed allows. Thus, if you selected the 19.2K Baud Rate setting, your fastest transmission rate will be 5 seconds and no faster. The Transmitter automatically determines these settings and adjusts the menu options accordingly. A complete table of these parameters is shown in the table in the following section.

In order to properly set the Normal Transmission Rate, you must first determine how often you need updates from the Transmitter when the device being monitored is operating within what you consider to be normal operating conditions for that process variable. You have a selectable range of 1-5, 10, 15, 20, 40 seconds and 1 minute. Then, follow the menu map shown in Figure 6.1 to configure the Normal Transmission Rate. The factory default is 10 seconds.

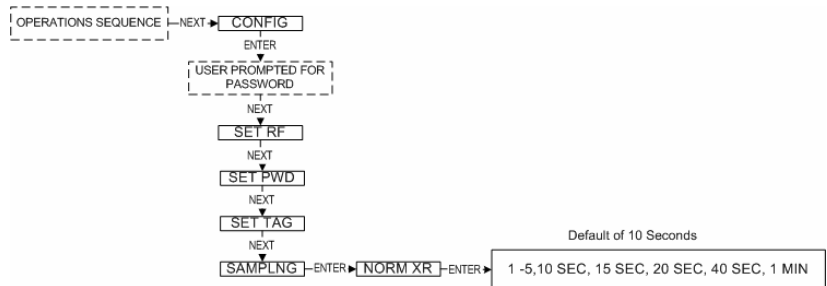

Figure 6.1: Menu Map to Normal Transmission Rate Setting

Using Wireless Management Toolkit

If you have the Wireless Management Toolkit software this menu option will not be accessible via the Transmitter once the Transmitter detects that the software is being used (See Appendix A for more details). An explanation of how to select the Normal Transmission Rate using the Wireless Management Toolkit software can be found in section 6.6.

* Indicates that Menu is Disabled if Wireless Management Toolkit is detected. (See Appendix A)

6.2: Selecting the Normal Sampling Rate*

As previously mentioned, the Transmitter is in “sleep” mode to save power during the operations sequence. This mode turns off most of the electronics on the unit (with the exception of the LCD) in order to preserve battery life. The Transmitter will then ‘wake up’ for every **Normal Sampling Period** and take the necessary current/voltage readings.

Notice that the minimum speed of the Normal Sampling Rate is dependent on the Normal Transmission Rate setting you selected earlier (see section 6.1). The Sampling Rates cannot be set to a slower time interval than the time interval at which the Transmitter is required to transmit updates. Thus, if you selected the Normal Transmit Rate setting to be 10 Seconds the Normal Sampling Rate must be set to 10 Seconds or faster. A complete table of these parameters is shown below.

Baud Rate (communication range)	76.8K	19.2K	4.8K
(speed of updates)	500-750 feet	2000-2500 feet	3000 feet
Normal and Abnormal Transmit Rates	1 Second or Greater	5 Seconds or Greater	20 Seconds or Greater
Normal and Abnormal Sampling Rates	Equal to Transmit Rate or Less	Equal to Transmit Rate or Less	Equal to Transmit Rate or Less

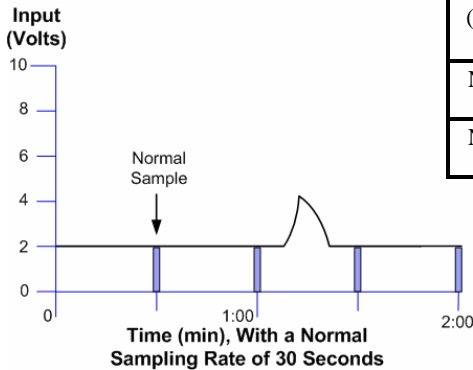

Figure 6.2: Incorrect Sampling Rate

In order to properly set the Normal Sampling Rate, first determine how often updates are needed from the Transmitter when the device being monitored is operating normally. You have a selectable range of 1-30 seconds. Note, however, the more frequently the Transmitter wakes up to check the monitored device, the faster you will use up the battery life of the Transmitter.

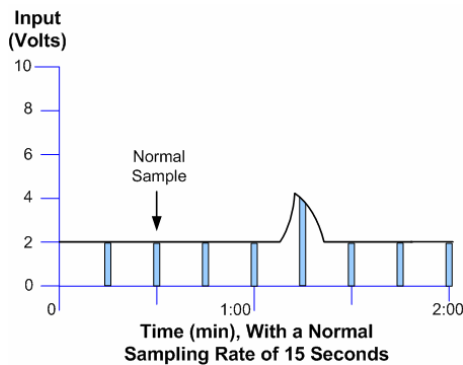

Figure 6.3: Correct Sampling Rate

Figure 6.2 is an example of what happens when the Normal Sampling Rate is too slow for the device being sampled. Notice how the rise in the voltage level falls between two normal samples, and thus goes completely undetected.

Figure 6.3 is an example of what happens when the normal sampling rate is correctly set for the device that is being monitored. Notice how this setting makes it possible to sample the rise in the voltage level.

Once you have decided on the proper Normal Sampling Rate follow the Transmitter menu map shown in Figure 6.4 to select this setting. The factory default is 1 second.

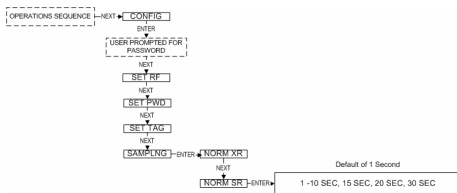

Figure 6.4: Menu Map to Normal Sampling Rate Setting

Using Wireless Management Toolkit

If you have the Wireless Management Toolkit software this menu option will not be accessible via the Transmitter once the Transmitter detects that the software is being used (See Appendix A for more details). An explanation of how to select the Normal Sampling Rate using the Wireless Management Toolkit software can be found in section 6.6.

* Indicates that Menu is Disabled if Wireless Management Toolkit is detected. (See Appendix A)

6.3: Selecting the Abnormal Transmission Rate*

NOTE
 If you do not need more or less frequent samples and updates from a Transmitter for a given application, then there is no need to complete this section. Simply set the Normal Transmission and Sampling Rates to the desired speeds, and make sure that the Normal Upper and Lower Values are configured to **Disabled**

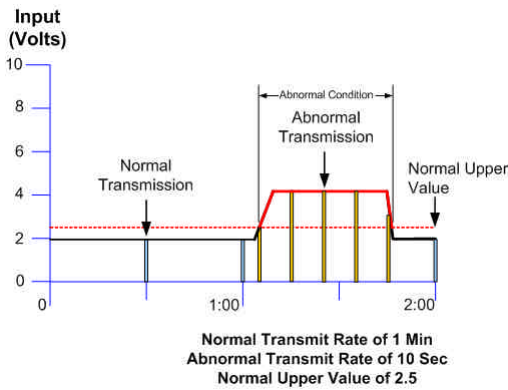

Figure 6.5: Example of Abnormal Transmission Rate Setting

The **Abnormal Transmission Rate** is identical to the Normal Transmission Rate with one exception. The Abnormal Transmission Rate only applies while the Transmitter is in an Abnormal condition (see Setting Normal Upper and Lower Values section 6.5). This allows you to increase or decrease the frequency of information you receive depending on the operating conditions of the device being monitored.

In order to properly set the Abnormal Transmission Rate, you must first determine how often the Transmitter needs to update its data about the device being monitored while in an Abnormal condition. You have a selectable range of 1-10, 15, 20, 40 seconds and 1 minute. Figure 6.5 is an example of how the device switches transmission rates from Normal Transmission Rate to Abnormal Transmission Rate. Note how the first abnormal transmission is sent immediately when the Normal Upper Value set point is exceeded. The next transmission will then follow this immediate transmission by 10 seconds (or whatever the Abnormal Transmission Rate is set to). The transmissions will continue at this interval until the process value drops below the Normal Upper Value set point.

Once the process value drops below this set point, another transmission is made to the Base Radio. The transmissions will then be made at the Normal Transmission Rate of one minute (or whatever the Normal Transmission Rate is set to) from the time of the last abnormal transmission.

The user should also note that the transmission time depends on the sampling rate, and when the process variable is sampled. If the Normal Sampling Rate is 30 seconds, then the process variable may be above the Normal Upper Value for up to 29 seconds before abnormal condition is detected. This means that the transmission could be as late as 29 seconds after the process variable exceeded the Normal Upper Value.

Once you have decided the proper time for the Abnormal Transmission Rate follow the Transmitter menu map shown in Figure 6.6.

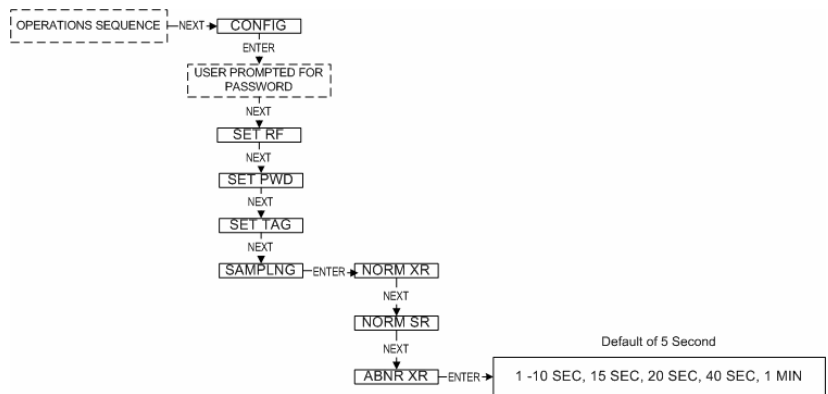

Figure 6.6: Menu Map to Abnormal Transmission Rate Setting

Using Wireless Management Toolkit

If you have the Wireless Management Toolkit software this menu option will not be accessible via the Transmitter once the Transmitter detects that the software is being used (See Appendix A for more details). An explanation of how to select the Abnormal Transmission Rate using the Wireless Management Toolkit software can be found in section 6.6.

* Indicates that Menu is Disabled if Wireless Management Toolkit is detected. (See Appendix A)

6.4: Selecting the Abnormal Sampling Rate*

NOTE
 If you do not need more or less frequent samples and updates from a Transmitter for a given application, then there is no need to complete this section. Simply set the Normal Transmission and Sampling Rates to the desired speeds, and make sure that the Normal Upper and Lower Values are configured to **Disabled**

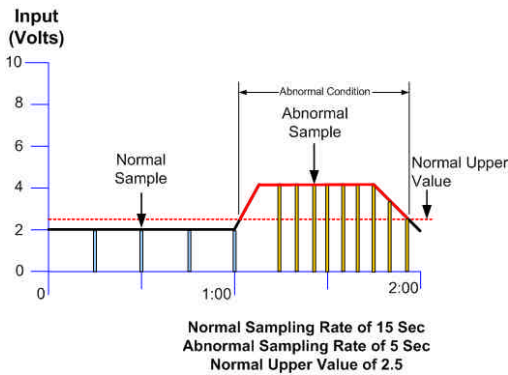

Figure 6.7: Example of Abnormal Sampling Rate Setting

The **Abnormal Sampling Rate** is identical to the Normal Sampling Rate with one exception. The Abnormal Sampling Rate only applies while the Transmitter is in an Abnormal condition (see Setting Normal Upper and Lower Values section 6.5). This allows you to increase or decrease the frequency of information you receive depending on the operating conditions of the device being monitored.

In order to properly set the Abnormal Sampling Rate, you must first determine how often the Transmitter needs to update its data while in an Abnormal condition. You have a selectable range of 1-10, 15, 20, 40 seconds and 1 minute. Figure 6.7 is an example of how the device switches sampling methods from Normal Sampling Rates to Abnormal Sampling Rates. Note how the first abnormal sample is taken a few seconds after the Normal Upper Value set point is exceeded. The next sample will then follow this sample by 5 seconds (or whatever the Abnormal Sampling Rate is set to). These samples will continue at this interval until the process value drops below the Normal Upper Value set point.

Once the process value drops below this set point the sampling rate will return to the Normal Sampling Rate. Also, the Abnormal Sampling must be equal to or faster than the Abnormal Transmission Rate.

The user should also note that the transmission time depends on the sample rate, and when the process variable is sampled. If the Normal Sampling Rate is 30 seconds, then the process variable may be above the Normal Upper Value for up to 29 seconds before abnormal condition is detected. This means that the transmission could be as late as 29 seconds after the process variable exceeded the Normal Upper Value.

Once you have decided the proper time for the Abnormal Sampling Rate follow the Transmitter menu map shown in Figure 6.8.

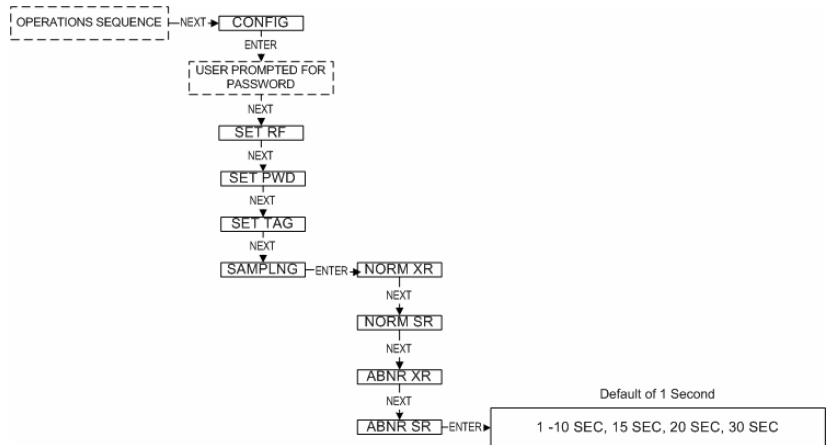

Figure 6.8: Menu Map to Abnormal Sampling Rate Setting

Using Wireless Management Toolkit

If you have the Wireless Management Toolkit software this menu option will not be accessible via the Transmitter once the Transmitter detects that the software is being used (See Appendix A for more details). An explanation of how to select the Abnormal Sampling Rate using the Wireless Management Toolkit software can be found in section 6.6.

* Indicates that Menu is Disabled if Wireless Management Toolkit is detected. (See Appendix A)

6.5: Selecting the Normal Upper and Lower Values*

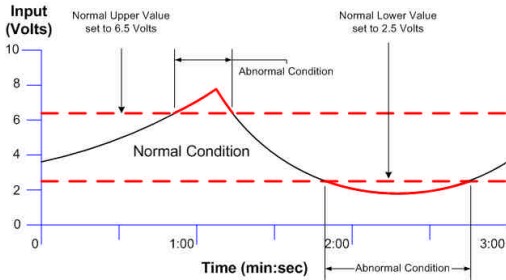

Figure 6.9: Normal Upper and Lower Value Example

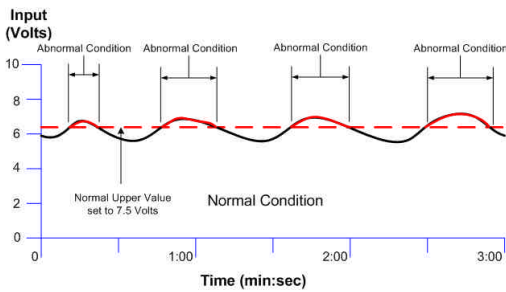

Figure 6.11: Condition "Chatter" Without Time Deadband

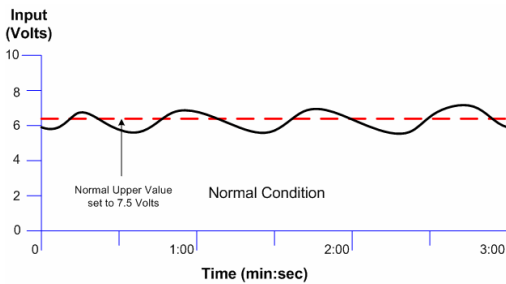

Figure 6.12: Condition "Chatter" Elimination Due to Time Deadband

Using Wireless Management Toolkit

Each Honeywell Transmitter is equipped with an input level upper and lower value. As the input is measured, it is compared to a set threshold value. Depending upon the setting of that value, whether it is enabled or not, and what the time deadband is, the Transmitter will enter an Abnormal condition as seen in Figure 6.10.

The Normal Upper Value would be an indication that the analog input is 'high' and the Normal Lower Value would be an indication that analog input is 'low'. Thus the normal operating condition for the input application would be found in between the two Normal Values. To configure the values, follow the Transmitter menu map shown in Figure 6.11.

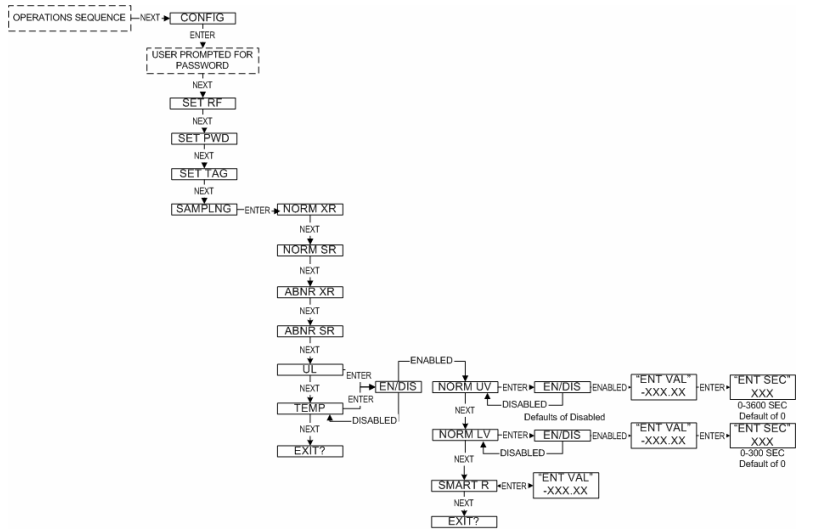

Figure 6.10: Menu Map to Normal Upper and Lower Value Setting

When configuring the Normal Values you will first be prompted to enable the input. You should only disable an input if it will not be used.

Once an input has been enabled, the user may enter a Normal Upper Value, Normal Lower Value and the Smart Rate Threshold (see Section 6.5). If, for example, the Normal Upper Value is enabled, the next prompt you will receive is -XX.XX for the process variable value. Increment this value to the desired value and press the ENTER button. (The "-" may be toggled on and off as well).

The final prompt you will receive is the Time Deadband prompt. The Time Deadband refers to the number of seconds that the measured reading must stay in a certain condition before, the Transmitter will actually switch to that condition. To select a proper Time Deadband consider the example in Figure 6.12. Notice that the Transmitter continues to cycle from Normal to Abnormal Conditions due to the fact that the input value is fluctuating around the 7.5 Volt Normal Upper Value. This is undesired. The addition of a few second delay before the Transmitter switches conditions will eliminate this "chatter", as seen in Figure 6.13.

If you have the Wireless Management Toolkit software this menu option will not be accessible via the Transmitter once the Transmitter detects that the software is being used (See Appendix A for more details). An explanation of how to select the Abnormal Sampling Rate using the Wireless Management Toolkit software can be found in section 6.6.

* Indicates that Menu is Disabled if Wireless Management Toolkit is detected. (See Appendix A)

6.6: Selecting Rates, Thresholds, and Deadbands via the Software

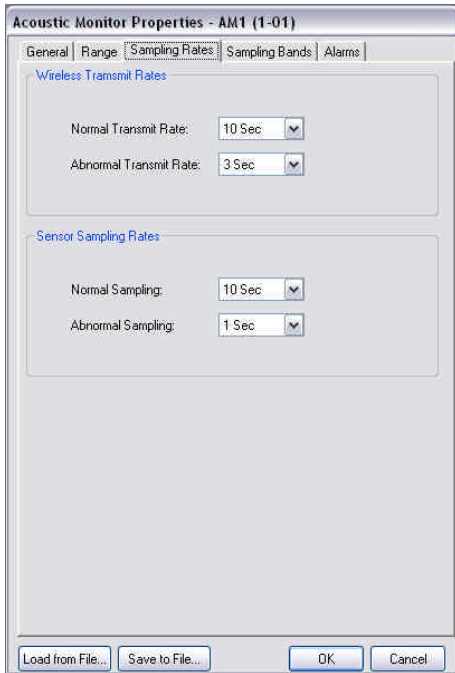

Figure 6.13: Sample and Transmission Rate Selection Using the Software

If you have the Wireless Management Toolkit software the Normal and Abnormal Sampling and Transmission menu options will not be accessible via the Transmitter once the Transmitter detects that the software is being used (See Appendix A for more details). These settings should be entered using the Wireless Management Toolkit software. To do so, enter the configuration menu (See Section 9.2 of the Wireless Management Toolkit User Manual). Once in the configuration menu click on the **Sampling Rates** tab to bring up the sampling rate information, as shown in Figure 6.10.

To select the Normal Transmission Rate, select one of the time periods from the drop box. Next, select an Abnormal Transmission Rate in the same manner. Note that the Normal and Abnormal Transmission Rate can be the same.

Once the transmission rates have been selected, the user should select the desired sampling rates. Note that the sampling rate must be equal to or faster than the associated transmit rate. For example, in Figure 6.10 the Normal Transmission Rate is set to 10 seconds and the Normal Sampling Rate is also set to 10 seconds. This is a valid configuration. Another example in Figure 6.10 is the Abnormal Transmission Rate being set to 3 seconds and the Abnormal Sampling Rate being set to 1 second.

If the user incorrectly enters the Transmission and Sampling Rates, a message will be displayed explaining this to the user. The user will not be allowed to leave this screen before the setting is corrected.

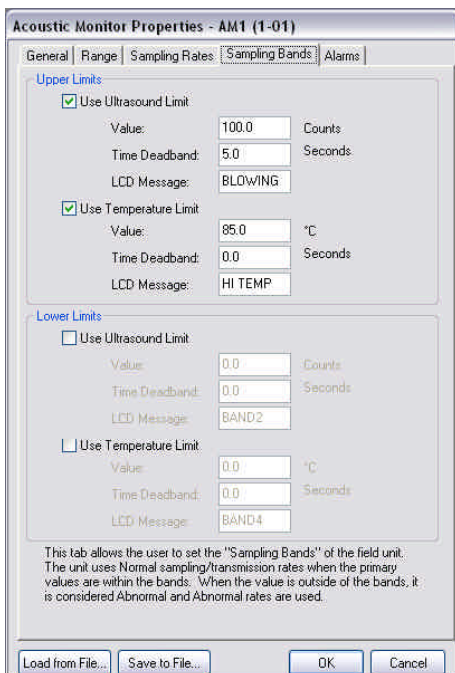

Figure 6.14: Normal Upper and Lower Value Selection Using the Software

If you have the Wireless Management Toolkit software the Normal and Normal Upper and Lower Value menu options will not be accessible via the Transmitter once the Transmitter detects that the software is being used (See Appendix A for more details). These settings should be entered using the Wireless Management Toolkit software. To do so, enter the configuration menu (See Section 9.2 of the Wireless Management Toolkit User Manual). Once in the configuration menu click on the **Sampling Bands** tab to bring up the sampling band information as shown in Figure 6.11.

To set a limit to the normal condition, enable the limit by clicking on the **Use Input X Limit** check box. Then enter the value and time deadband for the limit (for more details see Section 6.5 of this manual).

Section 7: Maintaining the Transmitter

The Transmitter is extremely easy to maintain in that it requires no periodic calibration or system checks. The Transmitter has a self diagnostic which is constantly checking the internal system. If any errors are found they are reported via the LCD, Base Radio or the software. A simple yearly visual inspection for the following is all that is needed:

- Is the Transmitter still securely fastened to the equipment being monitored?
- Are there any visible corrosions, cracks or residue build-ups on the unit?
- Has anything about the application changed from the original intended use?

8.1: Changing the Battery

⚠ Warning ⚠
Explosions may result in death or serious injury. Do not remove the instrument cover or open wiring housing in explosive atmospheres when power and communications are on. Instead, remove the Transmitter from the hazardous location and then proceed to open the instrument cover and replace the battery.

The battery will need to be changed within one month of seeing a ‘LOW BAT’ message on either the Transmitter. This is a simple process:

1. Make sure you have the correct replacement battery:

TADIRAN™ Lithium Inorganic Battery (non-rechargeable)
Size “C” – 3.6Volts
#TL2200/S
2. Power down the Transmitter by pressing and holding both the NEXT and ENTER buttons for a few moments.
3. Remove the 4 set screws on the sides of the Transmitter housing with a standard screw driver.
4. Remove the housing and locate the battery. Warning! When removing the housing do not twist or bend the green flex cable! Doing so may cause the tether to improperly seat next to the antenna and greatly reduce operable RF distances. Do not allow the housing to flop around while hanging by the tether.
5. Remove the old battery and replace it with the new battery positive end first. (Note that the positive end of the battery clip is the end with the red wire).
6. Plug the green wire tether back in and replace the housing. Then, screw the housing back on, and power up the unit by pressing either of the buttons.
7. Properly dispose of used battery.

Section 9: Technical Specifications

Acoustic Transducer Characteristics

- Center Frequency - 40kHz
- Bandwidth (3 dB) - 5kHz ($f_c \pm 2.5$ kHz)

Output Characteristics

- Amplitude is an 8-bit digital output with a scale from 0 to 255.

RF Characteristics

- 902 MHz – 928 MHz Frequency Hopping Spread Spectrum, FCC certified ISM license-free band
- Up to 3000' range from Base Radio with clear line of sight;
- The RF module in each field unit is individually tested and calibrated over the full temperature range to ensure reliable wireless operation

Operating Temperature Range

- -40 °F to +185 °F (-40 °C to +85 °C) electronics
- -4 °F to +158 °F (-20 °C to +70 °C) display (full visibility)
- -40 °F to +185 °F (-40 °C to +85 °C) display (with reduced visibility)

Physical Characteristics

- Brass and Cast Aluminum Base
- Optional Stainless Steel and Baked Enamel Base
- GE Lexan® Cover. V-0 Rating and UV Stable

Operating Vibration and Shock Characteristics

- Certified per IEC EN00068 2-6 (vibration) and 2-27 (shock)

Random Vibration Characteristics

- Certified to withstand 6 g's, 15 minutes per Axis from 9 – 500 Hz

Electromagnetic Compatibility (CE Compliance)

- Operates within specification in fields from 80 to 1,000 MHz with Field strengths to 30 V/m. Meets EN 50082-1 general immunity standard and EN 55011 compatibility emissions standard

Industrial Certification

- Rated for industrial use -40 °F to 185 °F (-40 °C to 85 °C)
- FM NEMA 4 weather-proof housing
- FM rated intrinsically safe for Class I/II/III, Division 1, Groups A,B,C,D,E,F&G; Class I/II/III, Division 2, Groups A,B,C,D,F&G

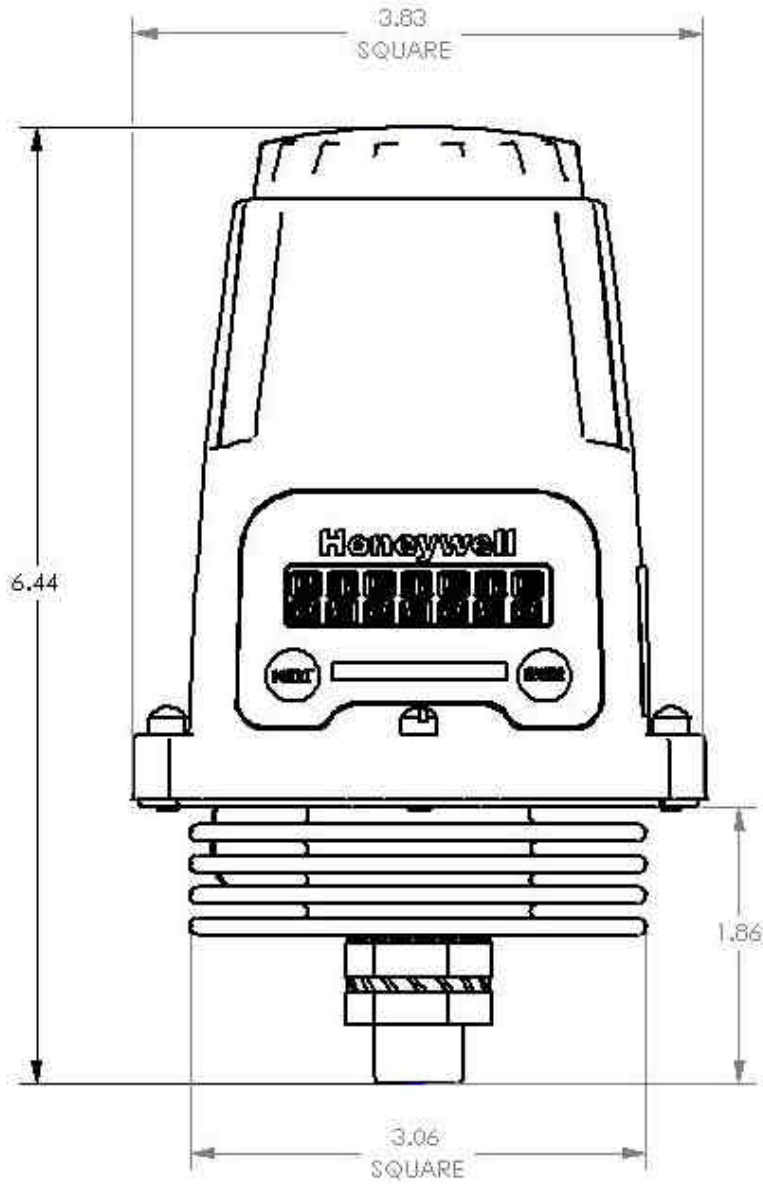

Dimensioned Mechanical Drawing

THE COPYRIGHT OF THIS DRAWING IS THE PROPERTY OF HONEYWELL. THE DRAWING IS SUPPLIED IN CONFIDENCE AND MUST NOT BE USED FOR ANY PURPOSE OTHER THAN THAT FOR WHICH IT IS SUPPLIED.

PREP BY		APPRO	
ISS		REVISION & DATE	
A	000503Z	RELEASED 06/07/04	WF

FM APPROVED INSTRINSICALLY SAFE INSTALLATION CONTROL DRAWING
XVR 5000, MODEL WISS1, DUAL 4 - 20 mA ANALOG INPUT

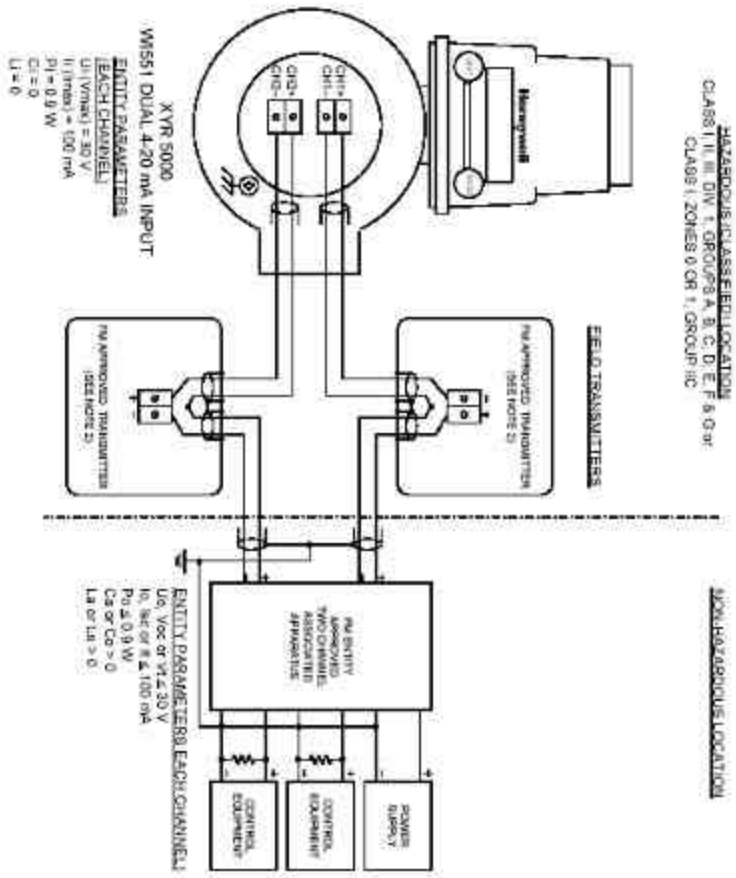

CERTIFICATION DOCUMENT	DRAWN	WF	021804
ENGINEERING CHANGE ORDERS (ECO) MUST BE AUTHORIZED BY APPROVALS ENGINEERING	CHECKED		
	DEV ENG		
	WFG ENG		
	QA ENG		
	TOLERANCE (UNLESS NOTED)		
	ANGULAR DIMENSION		

Honeywell

XVR 5000 Wireless Transmitters
IS Control Drawing, FM Approvals

SCALE **A/A4**

50001377

USED ON SH. 1 OF 5

XVR 5000, MODEL WISS2, DUAL 0 - 10 V ANALOG INPUT

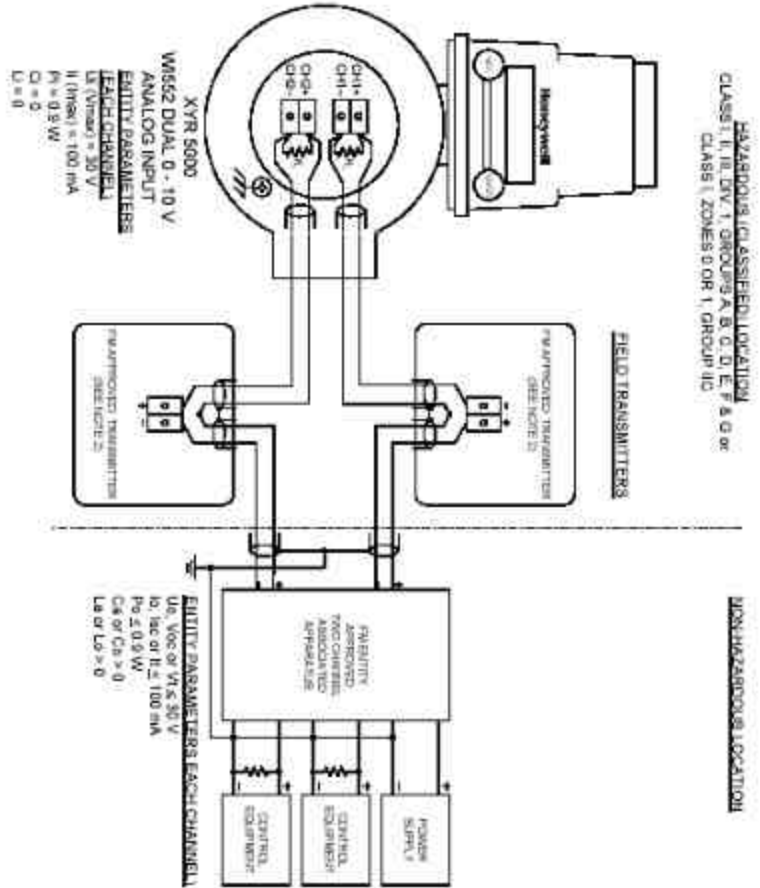

CERTIFICATION DOCUMENT	DRAWN	WF	021804
ENGINEERING CHANGE ORDERS (ECO) MUST BE AUTHORIZED BY APPROVALS ENGINEERING	CHECKED		
	DEV ENG		
	WFG ENG		
	QA ENG		
	TOLERANCE (UNLESS NOTED)		
	ANGULAR DIMENSION		

Honeywell

XVR 5000 Wireless Transmitters
IS Control Drawing, FM Approvals

SCALE NONE

50001377

REV. A DATE 06/07/04 SH. 2 OF 5

The Honeywell transmitters shown above are approved by FM Approvals as Intrinsic Safe for Class I, Division 1, applicable Groups, and Class I, Zones 0 and 1, Group IIC, when used in circuits supplied by FM-Entity approved Associated Apparatus (Barriers) with compatible parameters.

NOTES:

1. Intrinsically safe installation shall be in accordance with Articles 504 and 505 of the NEC[®], ANSINFPA 70, and ANSIS/ISA RPT12E.
2. The intrinsic Safety Entity concept allows the interconnection of two FM Approved Intrinsic safe devices with entity parameters not specifically examined in combination as a system when:
 U_0, V_0 or $V_1 \geq U_1$ or V_{max} , I_0, I_{sc} or $I_1 \geq I_1$ or I_{max} , C_0 or $C_1 \geq C_1 + C_{cable}$, L_0 or $L_1 \leq L_1 + L_{cable}$, $P_0 \geq P_1$ and there using a NRTL listed cable gland fitting.
3. For Class II and Class III installations where rigid metal conduit is not used, seal cable entries against dust and equipment that is connected to the associated apparatus must not use or generate more than 250 V.
4. Associated apparatus must be FM Approvals listed. Associated apparatus may be installed in a Class I, Division 2 Hazardous (Classified) location if so approved.
5. The installation of associated apparatus must comply with control drawings provided by the manufacturer of the associated apparatus, and the configuration of associated Apparatus must also be FM Approved under the Entity Concept.
6. The installation of field transmitter(s) must comply with control drawings provided by the manufacturer of the field transmitter, the Control Drawing, and the configuration of associated Apparatus must also be FM Approved under the Entity Concept.
7. Non-Separately isolated apparatus (Zener Barriers) must be connected to a suitable ground electrode per NFPA 70, Article 504 and 505. The resistance of the ground path must be less than 1.0 ohm.
8. These devices are suitable for installation in Classes I, II and III, Division 2, Group A, B, C, D, F & G, and Class I, Zone 2, AEX (A, Group IIC Hazardous (Classified) Locations without connection to associated apparatus (Zener Barriers).
9. Shielded two-wire cable is required for EMC conformity and is recommended for all installations. The shield shall be grounded at the supply (barrier) end only.
10. No revision of this control drawing is permitted without FM Approvals authorization.
11. For release approvals see ECO # 0005032.

XYR 5000	Field Transmitter	Associated Apparatus
U_0 or $V_{max} \leq 30$ V	U_1 or $V_{max} \leq V_1$	U_0, V_0 or $V_1 \leq 30$ V
I_0 or $I_{max} \leq 100$ mA	I_1 or $I_{max} \geq I_1$	I_0, I_{sc} or $I_1 \leq 100$ mA
$P_{max} \leq 0.9$ W	$P_{max} \geq P_0$	$P_0 \leq \frac{P_{max}}{4}$ (N_{oc} or V_1 - see art III)
$C_0 \leq 0$	$C_1 \leq$ Associated Apparatus C_0 - Cable - C_1 of other transmitter connected to two-channel barrier	C_0 or $C_1 \geq 0$ nF
$L_0 \leq 0$	$L_1 \leq$ Associated Apparatus L_0 - Cable - L_1 of other transmitter connected to two-channel barrier	L_0 or $L_1 \geq 0$ mH

Honeywell

SCALE NONE REV. A DATE 05/07/04 SH. 3 of 5

XYR 5000, MODEL WIS31R, REMOTE RTD INPUT
 HAZARDOUS (CLASSIFIED) LOCATION
 CLASS I, II, III, DIV. 1, GROUPS A, B, C, D, E, F & G OR
 CLASS I, ZONES 0 OR 1, GROUP IIC

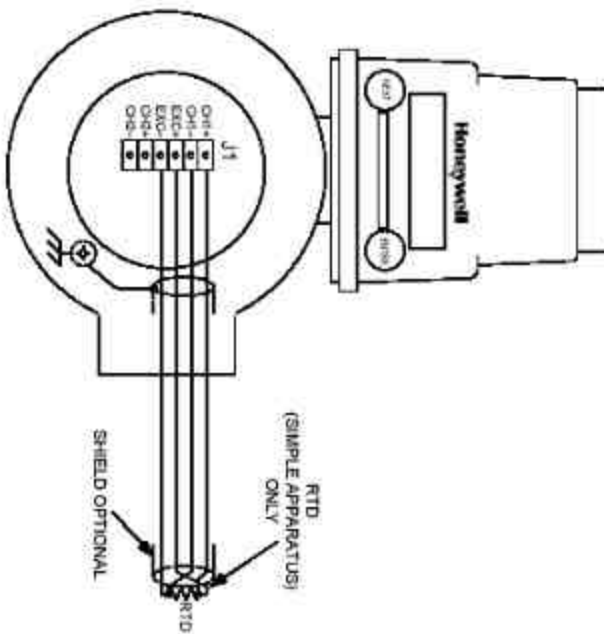

Honeywell

SCALE NONE REV. A DATE 05/07/04 SH. 4 of 5

XYR 5000, MODEL WI531T, DUAL REMOTE THERMOCOUPLE INPUT

HAZARDOUS (CLASSIFIED) LOCATION
CLASS I, II, III, DIV. 1, GROUPS A, B, C, D, E, F & G or
CLASS I, ZONES 0 OR 1, GROUP IIC

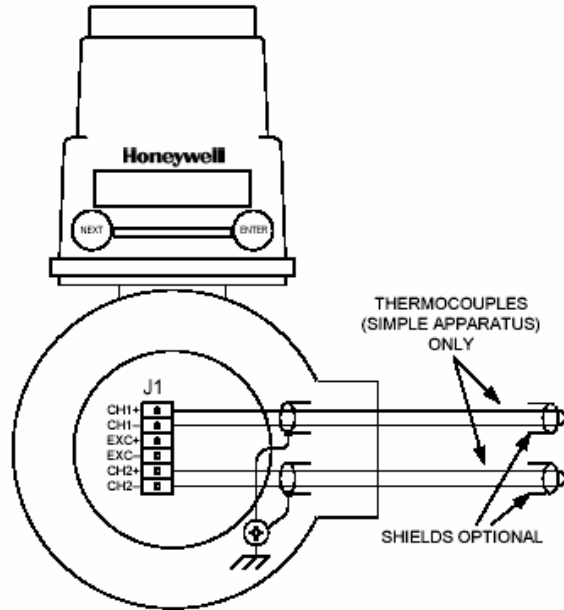

Honeywell

A/A4

50001377

SCALE NONE

REV A

DATE 050704

SH. 5 of 5

Appendix A: Navigating User Menus

Pressing either the NEXT or ENTER buttons located on the front of the Transmitter or Base Radio just below the Liquid Crystal Display (LCD) screen is all that is needed to navigate the respective menus. Pressing both of these buttons for one second will turn the unit on.

Pressing the NEXT button at any time while the Transmitter is cycling through the normal messages causes the Transmitter to enter the setup mode. The NEXT button is then used to step through menu options, and the ENTER button is used to enter a sub menu of what is displayed on the LCD at that time. If no button is pressed within a 30 second period the unit goes back to the normal display mode.

If you enter a sub menu that requires a numerical input, such as 001, the left most 0 will be blinking. This indicates that pressing the NEXT button will increment this value with each press from 0 to 9 and back to 0 again. Pressing the ENTER button will move to the next available value. If the last value is blinking, pressing ENTER will save the entered values and return from the sub menu.

If both the NEXT and ENTER buttons are depressed at once, a message on the LCD displaying OFF? will appear. If both buttons are released upon appearance of this message the user will be returned to the scrolling main screen. If both buttons are not released for the duration of the OFF? message the unit will power down and turn off. Note: If the unit is turned off while entering values in a sub menu, those values will NOT be saved.

* As shown throughout the document, this mark indicates that these menu options will automatically turn off if the Wireless Management Toolkit Software is used. All changes to these Transmitter menu options should be made through software instead. This is to prevent simultaneous changes from taking place. If you wish to discontinue use of the software and want these menus re-instated, you must contact your Honeywell Sales Representative.

Appendix B: Transmitter Displayed Message Definitions

This section covers the various messages, displayed on the Transmitter LCD, that occur during operation of the device.

Operations Sequence

- **RF Link Status**
 - ⇒ RF OK – Transmitter and Base Radio are communicating properly
 - ⇒ RF SYNC - Transmitter and Base Radio are attempting to synchronize communications.
 - ⇒ RF OFF - Transmitter's RF Channel is set to RF OFF
 - ⇒ NO RF - Transmitter and Base Radio have no communications
- **Input Level**
 - ⇒ XXX.XX – Currently measured Ultrasound Input level
 - ⇒ XX.XX°C – Currently measured Temperature Input level

Error Messages

If an error is detected with the operation of the Transmitter a message will be displayed on the Transmitter LCD (a corresponding message may also appear on the Base Radio LCD).

There are few types of error messages, warning and fatal. Warning messages are displayed as part of the normal cycling message sequence. These are:

- **LOW BAT** - battery should be replaced as soon as possible
- **NO RF** - can not detect Base Radio
- **S FAULT** - there is an open sensor or excitation wire detected. Also if a sensor value goes above/below logical limits. The unit will display 9999.99 for measurement (sensor fault mode); but will continue sampling and recover if the problem desists.
- **OVERRNG** - the device is measuring a value above/below sensor dependent bound values. For example the Analog Input device will report over-range if measurement is above 100% range of the Analog Input sensor. If the measurement goes above 150% full range, the unit will go into Sensor Fault mode. In over-range mode, the measurement is continued to be displayed, with the "OVERRNG" message to remind the user that the specified range of the sensor and the calibrated range of the device is being exceeded.

Fatal error messages will replace the normal cycling message sequence and will flash. A fatal message indicates the Transmitter is no longer operating normally and requires repair. These are:

- **RF ERR** - fatal error within RF communications
- **SEN ERR** - fatal error within the sensor electronics
- **SYS ERR** - fatal error within the microprocessor system
- **RF CAL** - fatal error within the RF calibration system

Appendix C: Transmitter Menu Map

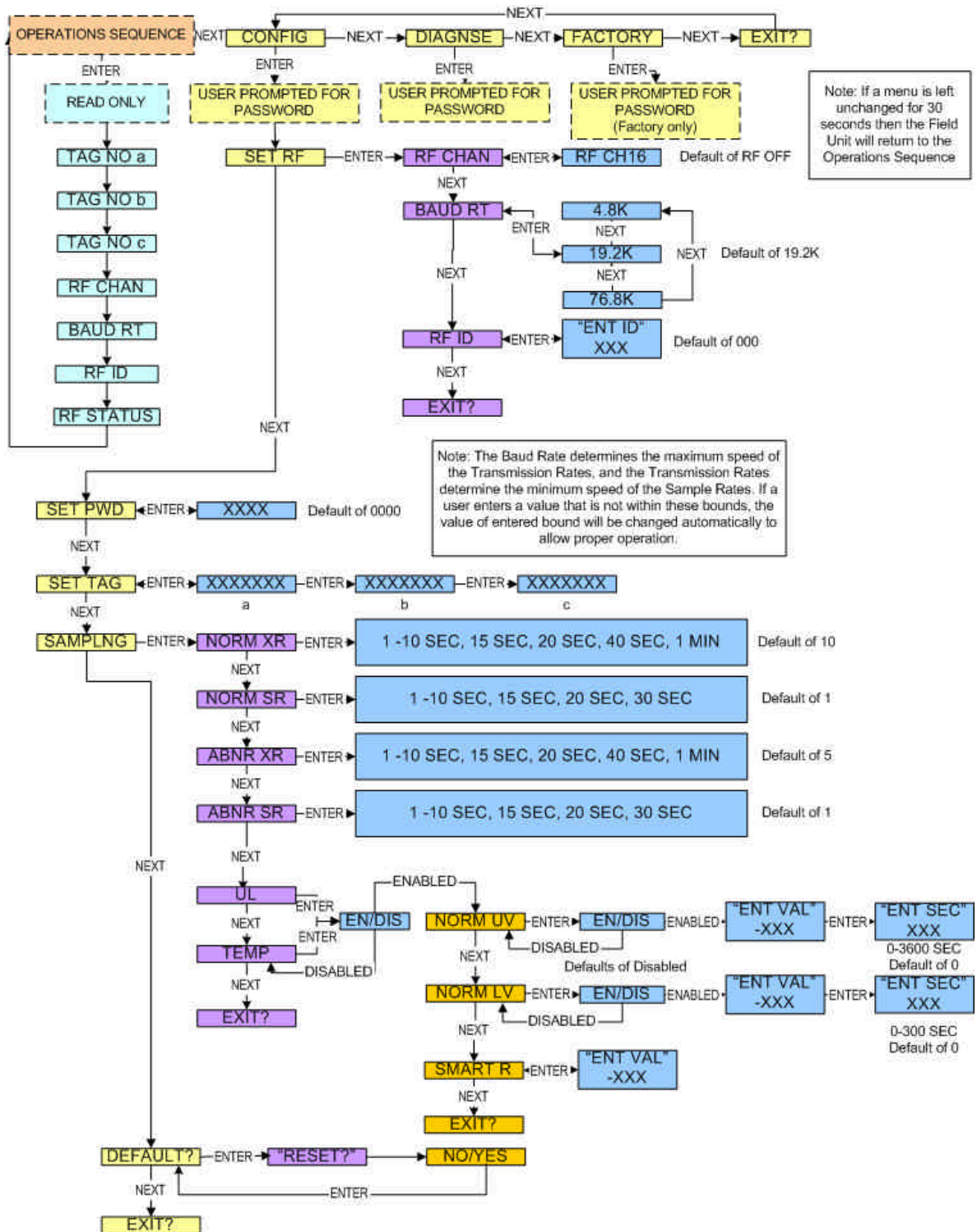

Honeywell

Industrial Measurement and Control

2500 W. Union Hills Drive

Phoenix AZ, 85027