

SITRANS F M MAGFLO®

Electromagnetic flowmeters

Transmitter types MAG 5000, MAG 6000

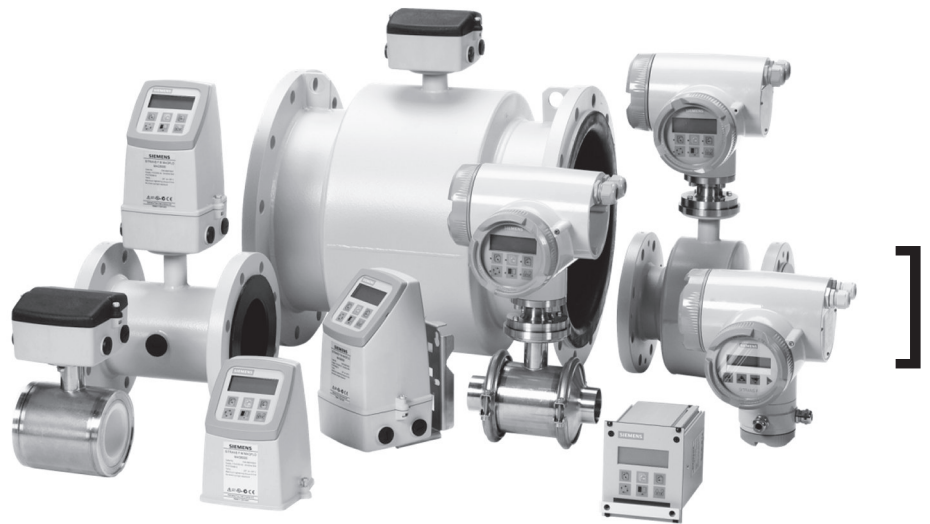

Technical Documentation (handbooks, instructions, manuals etc.) on the complete product range SITRANS F can be found on the internet/intranet on the following links:

English: <http://www4.ad.siemens.de/WW/view/en/10806951/133300>

Order no.: FDK-521H1177

SFIDK.PS.027.Z8.22



1.1 Transmitter MAG 5000 & MAG 6000 (1/4" to 78")

		MAG 5000 accuracy 0.5% MAG 6000 accuracy 0.25% (0.5% for MAG 3100 W sensor)										
Current output												
Active current	0-20 mA, 4-20 mA or 4-20 mA + alarm (Power supplied from flowmeter)											
Load	< 800 ohm											
Time constant	0.1-30 sec. adjustable											
Digital output												
Frequency	0-10 kHz, 50% duty cycle											
Time constant	0.1-30 sec. adjustable											
Active pulse	24 V DC, 30 mA, $1\text{ K}\Omega \leq R_{load} \leq 10\text{ K}\Omega$, short-circuit-protected (Power supplied from flowmeter)											
Passive pulse	3-30 V DC, max. 110 mA, $200\ \Omega \leq R_{load} \leq 10\text{ K}\Omega$ (Powered from connected equipment)											
Relay												
Time constant	Changeover relay, time constant same as current time constant											
Load	42 V AC/2 A, 24 V DC/1A											
Digital input		11-30 V DC, $R_i = 4.4\text{ K}\Omega$										
Activation time	50 msec.											
Current	$I_{11\text{ V DC}} = 2.5\text{ mA}$, $I_{30\text{ V DC}} = 7\text{ mA}$											
Functions		Flowrate, 2 totalizers, low flow cut-off, empty pipe cut-off, flow direction, error system, operating time, uni/bidirectional flow, limit switches, pulse output, control for cleaning unit and batching ²⁾										
Galvanic isolation		All inputs and outputs are galvanically isolated										
Cut-off												
Low flow	0-9.9% of maximum flow											
Empty pipe	Detection of empty pipe ¹⁾											
Totalizer		Two eight-digit counters for forward, net or reverse flow										
Display		Background illumination with alphanumerical text, 3 x 20 characters to indicate flowrate, totalized values, settings and faults										
	Reverse flow indicated by negative sign											
Time constant	Time constant as current output time constant											
Zero point adjustment		Automatic										
Electrode input impedance		$> 1 \times 10^{14}\ \Omega$										
Excitation frequency		Sensor size depending pulsating DC current (125 mA)										
Ambient temperature		Display version during operation: -5 to 120°F										
	Blind version during operation: -5 to 140°F											
	During storage: -40 to 160°F (Relative humidity max 95%)											
Custody transfer approval		<table border="1" style="width: 100%; border-collapse: collapse;"> <tr> <td style="width: 33%;">PTB (cold water)</td> <td style="width: 33%;">DANAK OIML R75²⁾</td> <td style="width: 33%;">DANAK OIML R117²⁾</td> </tr> <tr> <td style="text-align: center;">6.221</td> <td style="text-align: center;">(hot water)</td> <td style="text-align: center;">(cold water/milk, beer etc.)</td> </tr> <tr> <td style="text-align: center;">99.19</td> <td></td> <td></td> </tr> </table>		PTB (cold water)	DANAK OIML R75 ²⁾	DANAK OIML R117 ²⁾	6.221	(hot water)	(cold water/milk, beer etc.)	99.19		
PTB (cold water)	DANAK OIML R75 ²⁾	DANAK OIML R117 ²⁾										
6.221	(hot water)	(cold water/milk, beer etc.)										
99.19												
Communication												
Standard	Prepared for client mounted add-on modules ²⁾											
Optional	HART, Profibus PA & DP, Modbus RTU, CANopen, DeviceNet as add-on module ²⁾ , HART (MAG 5000)											
Integral mount												
Enclosure material	Fiberglass-reinforced polyamide											
Enclosure rating	NEMA 4X / 6 (3 ft. submersion for 30 min)											
Mechanical load	18-1000 Hz random, 3.17 G rms in all directions to EN 60068-2-36											
Rack mount												
Enclosure material	Standard rack mount of aluminum/steel (DIN 41494)											
	Width: 4.75 inch											
	Height: 5.25 inch											
Enclosure rating	NEMA 2											
Mechanical load	Version: 1 G, 1-800 Hz sinusoidal in all directions to EN 60068-2-36											
EMC performance		Emission: EN 50081-1 (Light industry)										
	Immunity: EN 50082-2 (Industry)											
Power supply		115-230 V AC +10% to -15%, 50-60 Hz										
	11-30 V DC or 11-24 V AC											
	Fuse: 250 V ~ 500 mA T											
Power consumption		230 V AC: 17 VA										
	24 V DC: 9 W, $I_N = 380\text{ mA}$, start-up peak current = 8A (30 msec.)											
	12 V DC: 11 W, $I_N = 920\text{ mA}$, start-up peak current = 4A (250 msec.)											
Approvals		FM Class 1, division 2, ULc general purpose										

1) Special cable required in separate mounted installation, 2) MAG 6000 only

1.2 Output characteristics MAG 5000 & MAG 6000

Output characteristics 0-20 mA	Bidirectional mode		Unidirectional mode	
4-20 mA				
Frequency				
Pulse output				
Relay	Power down		Active	
Error relay	No error		Error	
Limit switch or direction switch	1 set point		2 set points	
	Low flow (Reverse flow)		Intermediate flow	
	High flow (Forward flow)		High flow/ Low flow	
Batch on digital output (MAG 6000 only)				
Batch on relay (MAG 6000 only)	Hold		Batch	

1.3.1 Sensor cables and conductivity of medium

Conductivity of medium	Compact installation: Liquids with an electrical conductivity $\geq 5 \mu\text{S/cm}$. For a conductivity between 5 and $10 \mu\text{S/cm}$, the repeatability may degrade to $\pm 0.5\%$ of actual flow.	
	<p>Remote installation:</p>	

Note For detection of empty sensor the min. conductivity must always be $\geq 20 \mu\text{S/cm}$ and the max. length of electrode cable when remote mounted is 150 ft. Special cable must be used. For remote mounting in Ex applications special cable cannot be used, empty sensor cannot be detected and the electrical conductivity must be $\geq 30 \mu\text{S/cm}$. For remote mounted CT installations the max. cable length is 600 ft.

1.3.2 Minimum accept data for cable

Basic data	Coil cable		Electrode cable
	No. of conductors	2	3
Min. sqr. area	0.5 mm ² /20 gage	0.2 mm ² /22 gage	
Screen	Yes	Yes	
Max. capacitance	N.A.	107 pF/ft.	
Max. cable loop resistance	Media temperature: $< 210^\circ\text{C}$	40 Ω	N.A.
	$< 390^\circ\text{C}$	6 Ω	N.A.

2.1 Transmitter
MAG 5000 & MAG 6000
connection diagram

Safety Note

Only qualified personnel should perform wiring or repairs, and only when the transmitter is not powered. Install transmitter in accordance with all relevant NEC and local codes.

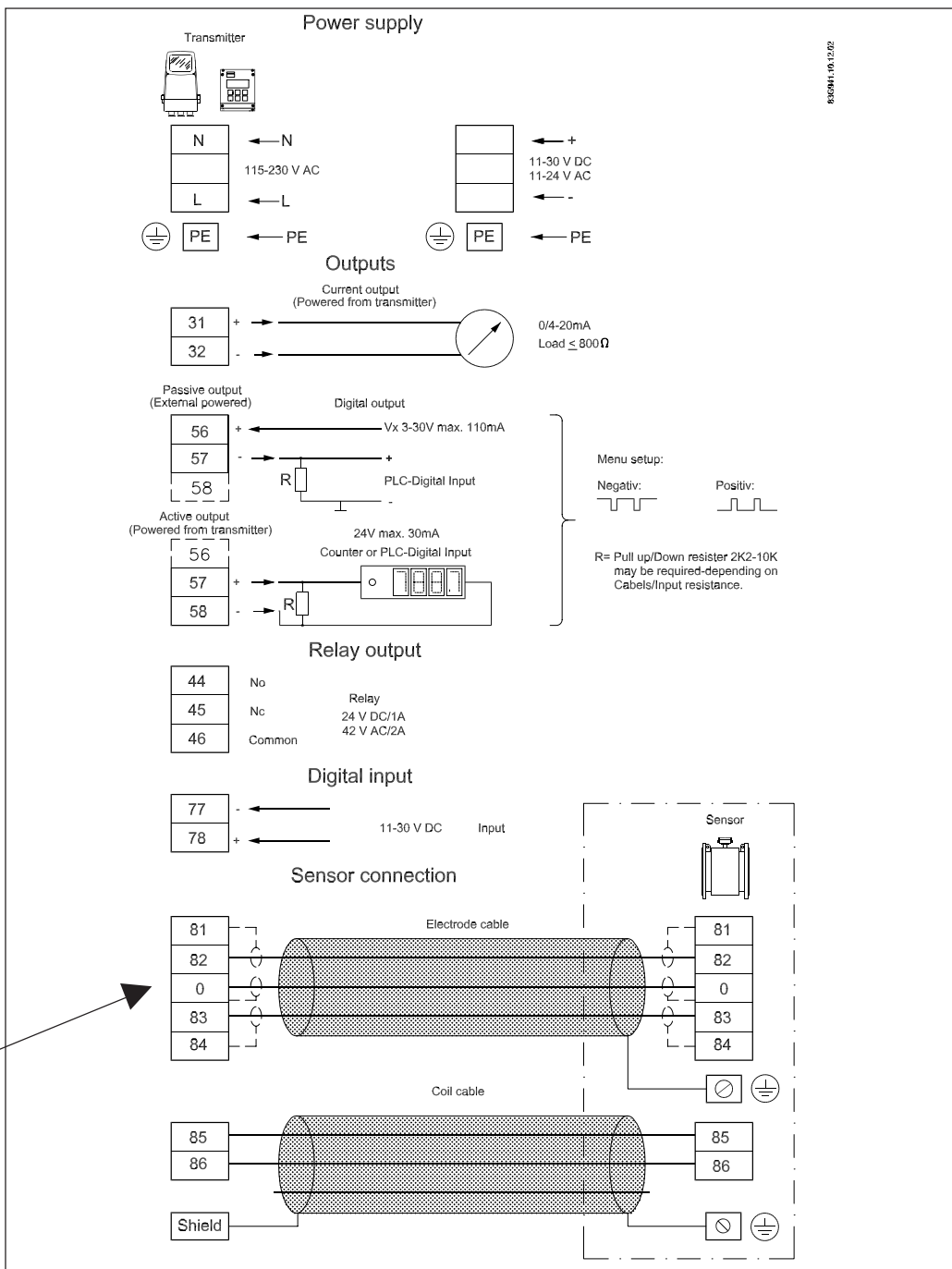

Special cable with individual wire shields (shown with dashed lines) are only required when using empty pipe function with low conductivity process (see "Specifications")



Potential Hazards / Grounding

The mains protective earth wire must be connected to the PE terminal in accordance with the diagram (class 1 power supply).

Mechanical counters

When mounting a mechanical counter to terminals 57 and 58 (active output), a 1000 μF capacitor must be connected to the terminals 56 and 58. Capacitor + is connected to terminal 56 and capacitor - to terminal 58.

Output cables

If long cables in noise environment, we recommend to use screened cable.

Electrodes cables

Dotted connections only to be when using special electrode cable.



Mains supply 115 to 230 V AC from building installation Class II. A switch or circuit-breaker (max. 15 A) shall be included in the building installation. It must be in close proximity to the equipment and within easy reach of the operator, and it shall be marked as the disconnecting device for the equipment.

3.1 Integral installation
MAG 5000 and
MAG 6000

Note
System will **not** register flow if black plugs are not connected to connection board

Caution
Exposing the transmitter to direct sunlight may increase the operating temperature above its specified limit, and decrease display visibility

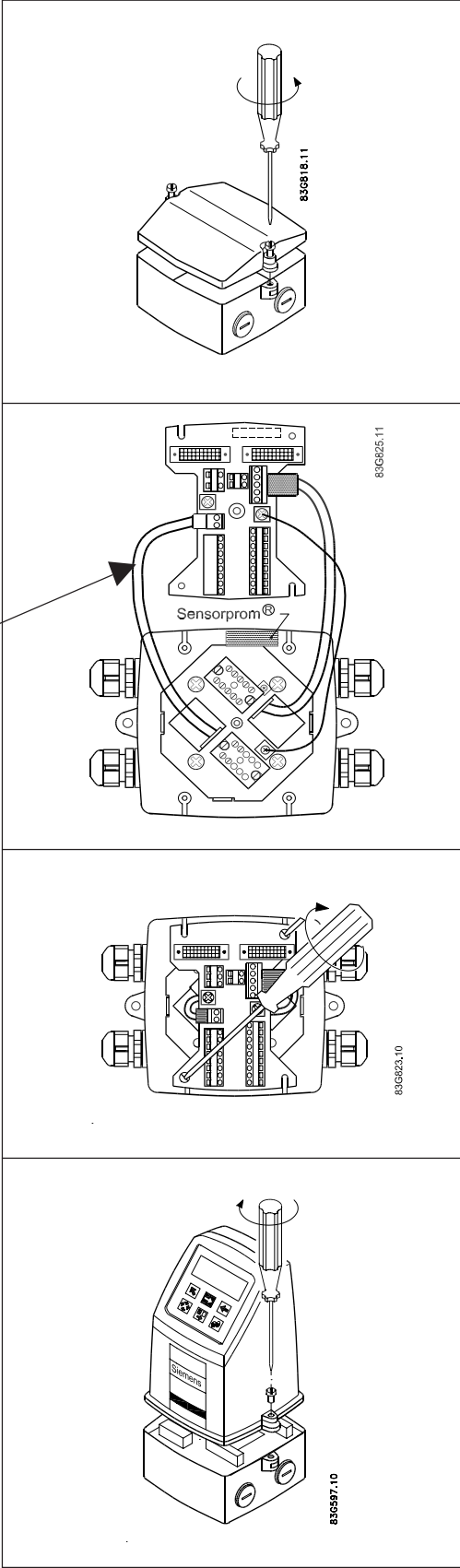

Step 1
Remove and discard the terminal box lid of the sensor.

Fit the PG 13.5 cable glands for the supply and output cables.

Step 2
Remove the two black plug assemblies for coil and electrode cables in the terminal box and connect them to their corresponding terminal numbers on the connection board.

Step 3
Connect an earth wire between PE on connection board and bottom of terminal box. Connect the 2 pin connector and 3 pin connector as shown.

Note
In earlier version the 3 pin connector was a 5 pin connector.

Step 4
Mount the connection plate in the terminal box. The SENSORPROM® unit connections will be established automatically when the connection plate is mounted in the terminal box.

Note
Check that your connection board lines up with the SENSORPROM® unit, if not, move the SENSORPROM® unit to the other side of the terminal box.

Step 5
Fit the supply and output cables respectively and tighten the cable glands to obtain optimum sealing. Please refer to the wiring diagram "Electrical connections".

Mount the transmitter on the terminal box.

3.2.1 Remote installation - Sensor end

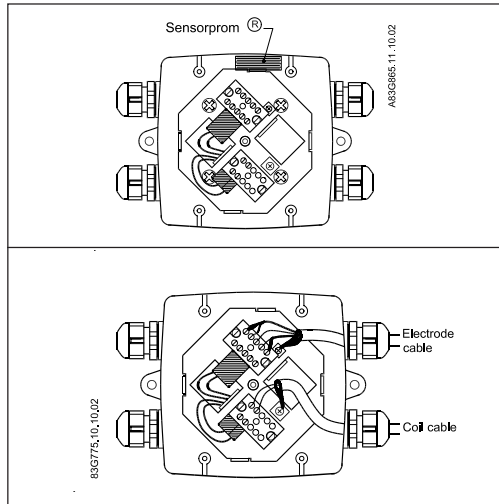

Step 1 (All transmitter types)
 Remove the SENSORPROM® unit from the sensor terminal box and mount it under the connection board for the transmitter (please refer to the following pages for specific mounting types).

Step 2 (All transmitter types)
 Fit and connect the electrode and coil cables as shown in "Electrical connections". The unshielded cable ends must be kept as short as possible. The electrode cable and the coil cable must be two separate cables to prevent interference. Tighten the cable glands well to obtain optimum sealing. The two cables can run in the same conduit.

⚠ Mount the terminal box lid before power up.

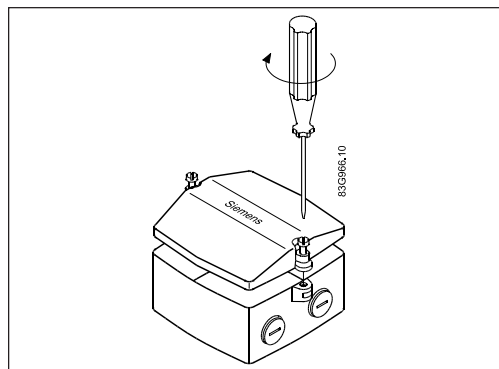

3.2.2 Remote installation - Wall mount

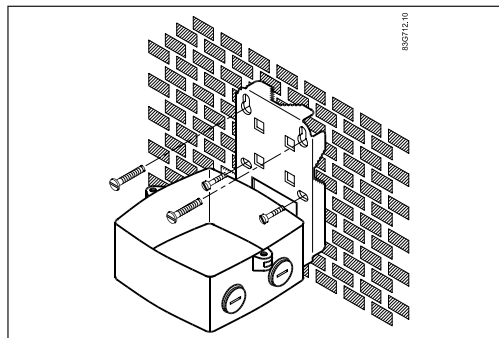

Step 3 (Wall mounting)
 Mount wall bracket on a wall or in the back of a panel.

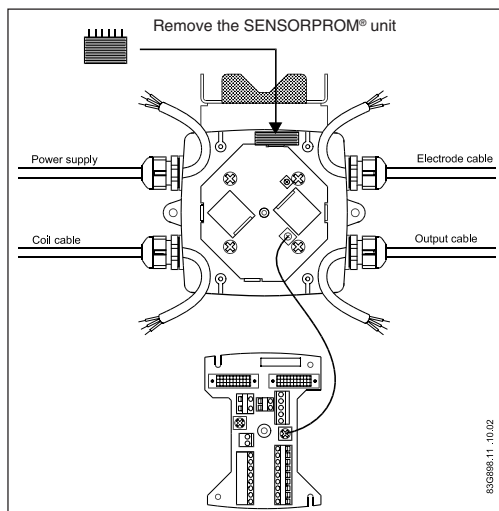

Step 4 (Wall mounting)
 Remove the SENSORPROM® unit from the sensor terminal box. Mount the SENSORPROM® unit in the wall mounting terminal box as shown. The text on the SENSORPROM® unit must face towards the wall bracket.

Mount an earth wire between PE on the connection board and bottom of terminal box.

3.2.2 Remote installation - Wall mounting (continued)

Caution
Exposing the transmitter to direct sunlight may increase the operating temperature above its specified limit, and decrease display visibility

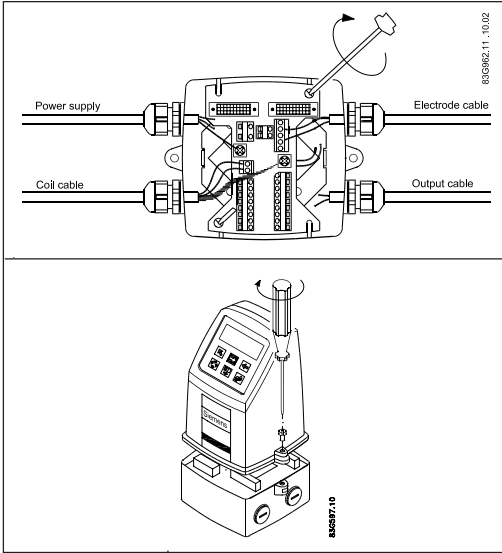

Step 5 (Wall mounting)
Mount the connection board in the terminal box. Fix the connection board with the two diagonal opposite screws.

Fit the coil, electrode, supply and output cables respectively and tighten the cable glands to obtain optimum sealing. Please see the wiring diagram in "Electrical connections".

Step 6 (Wall mounting)
Mount the transmitter on the terminal box.

Attention
When remote mounted, power supply PE wire must be connected to PE terminal. Coil cable shield must be connected to SHIELD terminal. Use the supplied insulating tube to insulate the core shield.

3.2.3 Remote installation - Rack mount

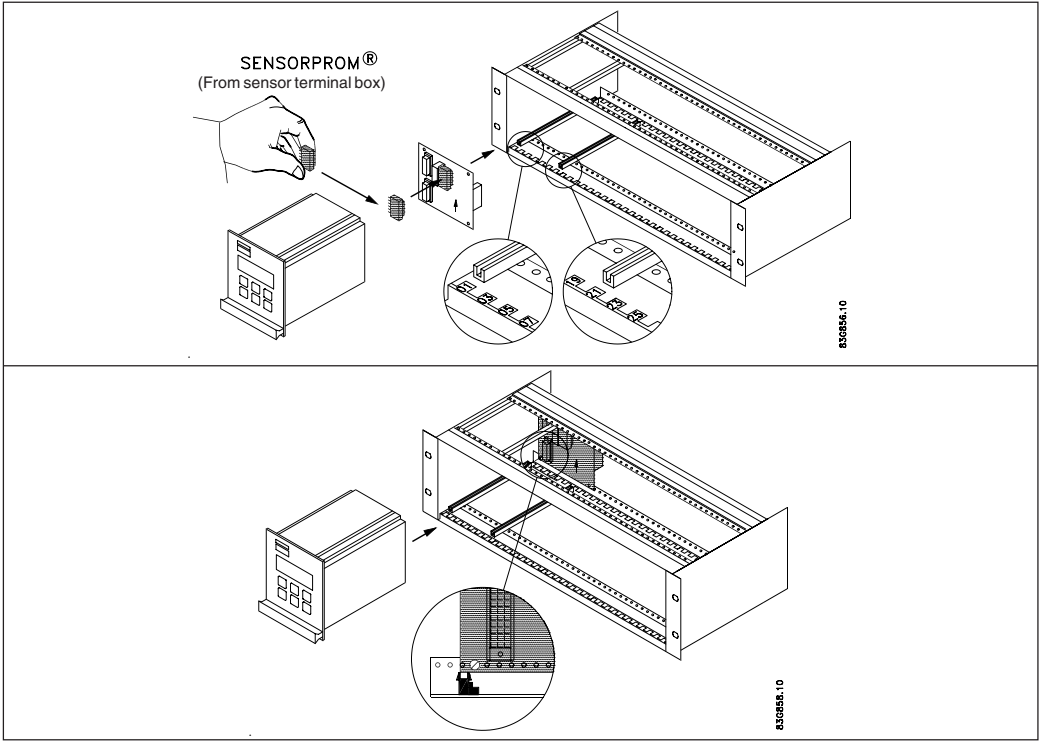

Step 1 + 2
Please refer to previous page.

Step 3 (Rack mount units)
Mount the SENSORPROM® memory unit on the connection board supplied with the transmitter as shown. **The SENSORPROM® unit is supplied with the sensor in the terminal box.**







Step 4 (Rack mount units)
Mount the guide rails in the rack system as shown. Distance between guide rails is 4.52 inch. Guide rails are supplied with the rack system and not with the transmitter.

Step 5 (Rack mount units)
Mount the connection board as shown. Board to be mounted on the inside.

Step 6 (Rack mount units)
Connect the cables as shown under "Electrical connection".

Step 7 (Rack mount units)
Insert the transmitter into the rack system.

4.1 MAG 5000 & MAG 6000

- TOP UP KEY  This key (hold 2 sec.) is used to switch between operator menu and setup menu. In the transmitter setup menu, a short press will cause a return from a submenu
- PAGE FORWARD KEY  This key is used to step forward through the menus.
- PAGE BACKWARD KEY  This key is used to step backward through the menus.
- CHANGE KEY  This key changes the settings or numerical values.
- SELECT KEY  This key selects the figures to be changed.
- LOCK/UNLOCK KEY  Process activation

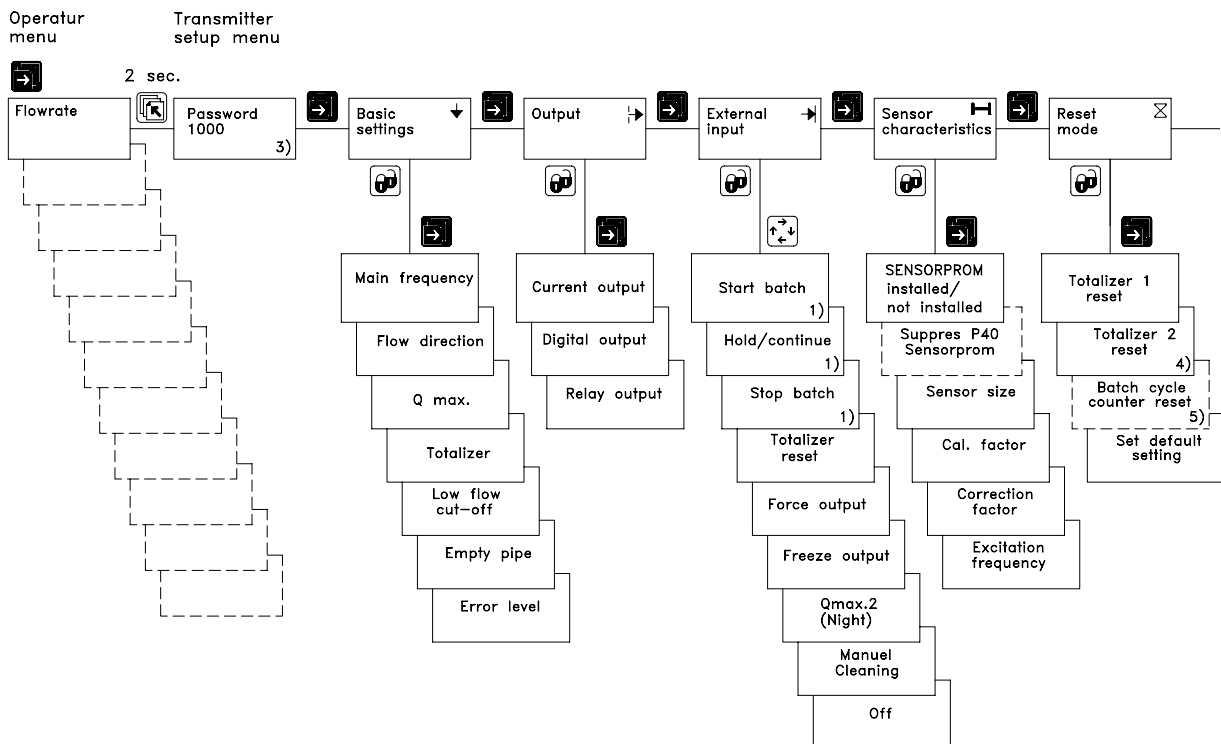

- 1) Mag 6000 I only
- 2) Add on module
- 3) Factory set password: 1000
- 4) Not at Batch
- 5) At Batch only

4.1 MAG 5000 & MAG 6000 (continued)

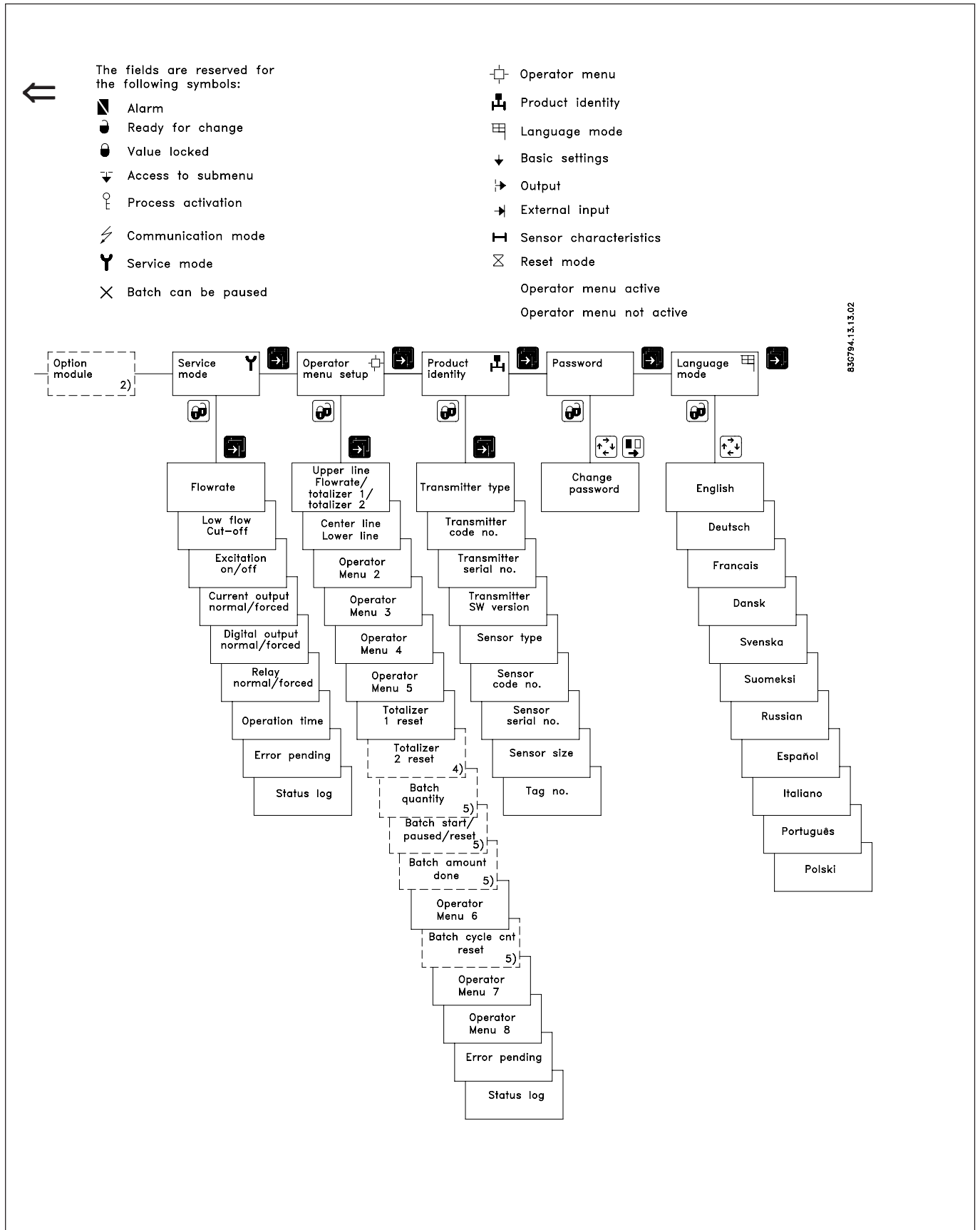





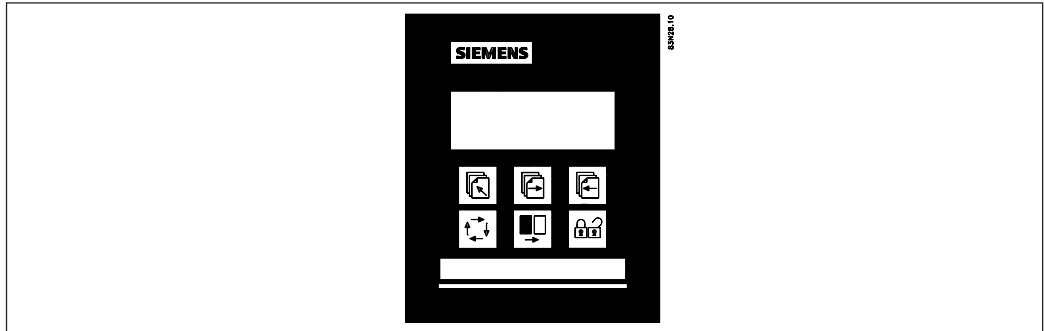

830794.1.3.13.02

4.2 Keypad and display layout



Keypad

The keypad is used to program the flowmeter. The function of the keys is as follows:

- TOP UP KEY  This key (hold 2 sec.) is used to switch between operator menu and setup menu. In the transmitter setup menu, a short press will cause a return to the previous menu.
- FORWARD KEY  This key is used to step forward through the menus. It is the only key normally used by the operator.
- BACKWARD KEY  This key is used to step backward through the menus.
- CHANGE KEY  This key changes the settings or numerical values.
- SELECT KEY  This key selects the figures to be changed.
- LOCK/UNLOCK KEY  This key allows the operator to change settings, save changes and gives access to submenus.

Display

The display is alphanumerical and indicates flow values, flowmeter settings and error messages. The upper line is for primary flow readings and will always show either flow rate, totalizer 1 or totalizer 2. The line is divided into 3 fields.













- S: Sign field
- P: Primary field for numerical value
- U: Unit field

The centre line is the title line (T) with individual information according to the selected operator or setup menu.





The lowest line is the subtitle line (ST) which either will add information to the title line or keep individual information independent of the title line.

F: The alarm field.  Two flashing triangles will appear by a fault condition.

M: The mode field. The symbols indicate the following.

 Communication mode	 Basic settings	 Operator active
 Service mode	 Output	 Operator inactive
 Operator menu	 External input	
 Product identity	 Sensor characteristics	
 Language mode	 Reset mode	



L: The lock field. Indicates the function of the lock key.

 Ready for change	 Access to submenu
 Value locked (saved)	 RESET MODE: Zero setting of totalizers and initialization of setting

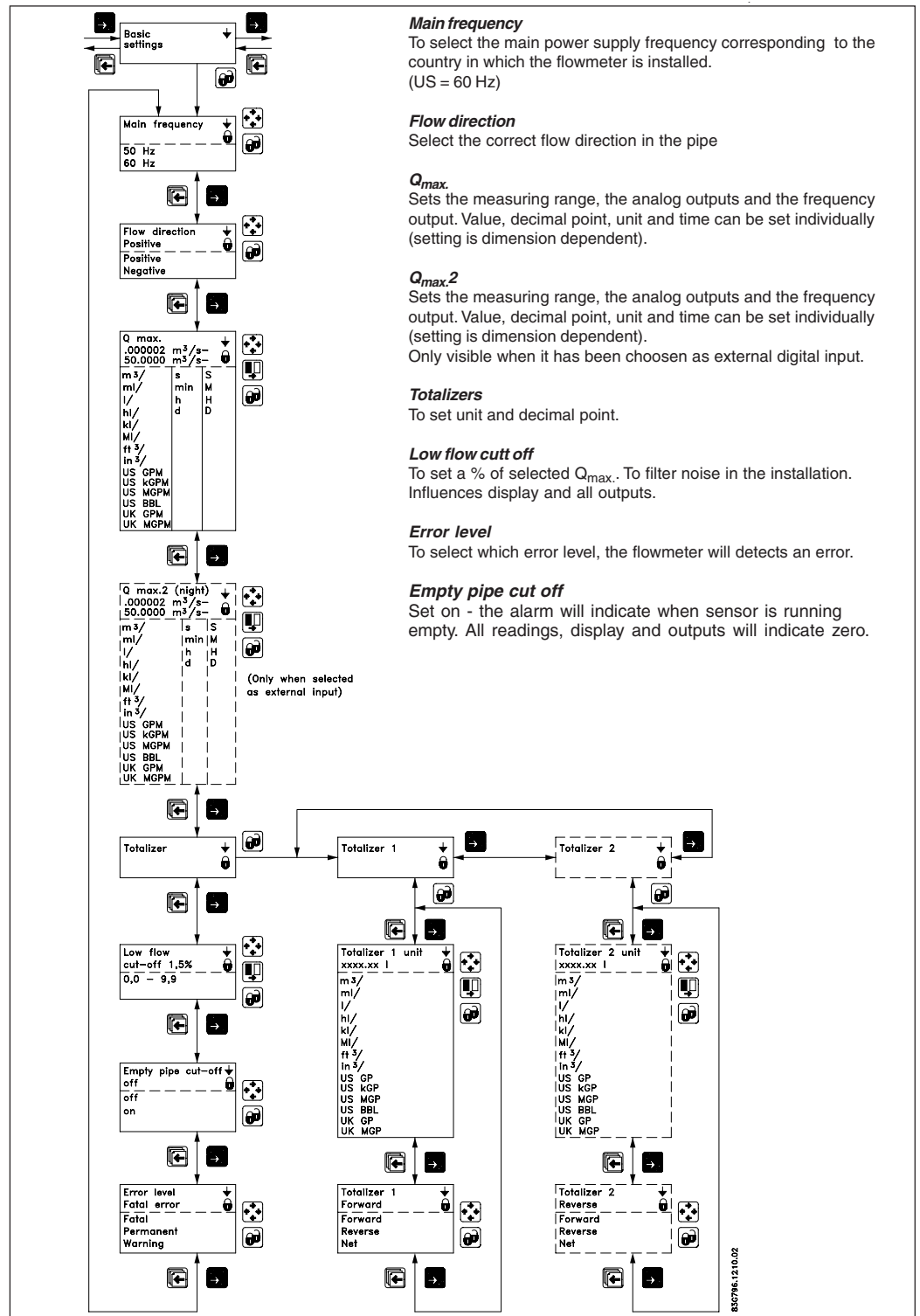
4.3.1 Basic settings



Comma for flow rate, totalizer 1 and totalizer 2 can be individually positioned.

- open the respective window.
- ensure that the cursor is positioned below the comma. Use the SELECT KEY .
- move the comma to the requested position. Use the CHANGE KEY .

Units are changed by means of the CHANGE KEY  with the cursor placed below the unit selected. Select units (cursor moved) by means of the SELECT KEY .

Totalizer 2 is not visible when batch is selected as digital output.

Q_{max. 2} - is only visible when it has been chosen as external input.

4.3.2 Outputs

Current output
Proportional to flowrate
(Terminal 31 and 32)

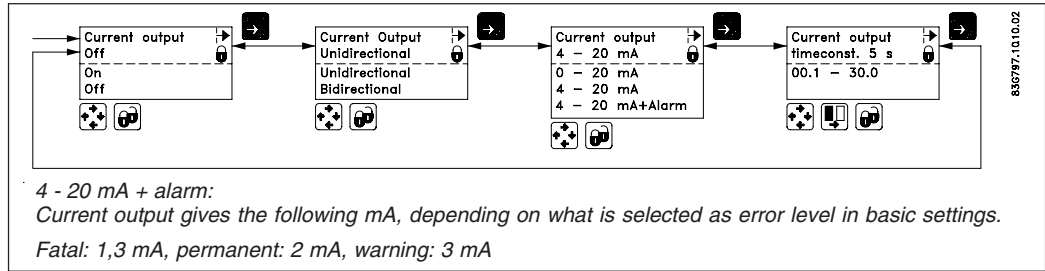

The current output must be turned off when not used.

Digital output
Pulse/volume
(Terminal 56, 57, 58)

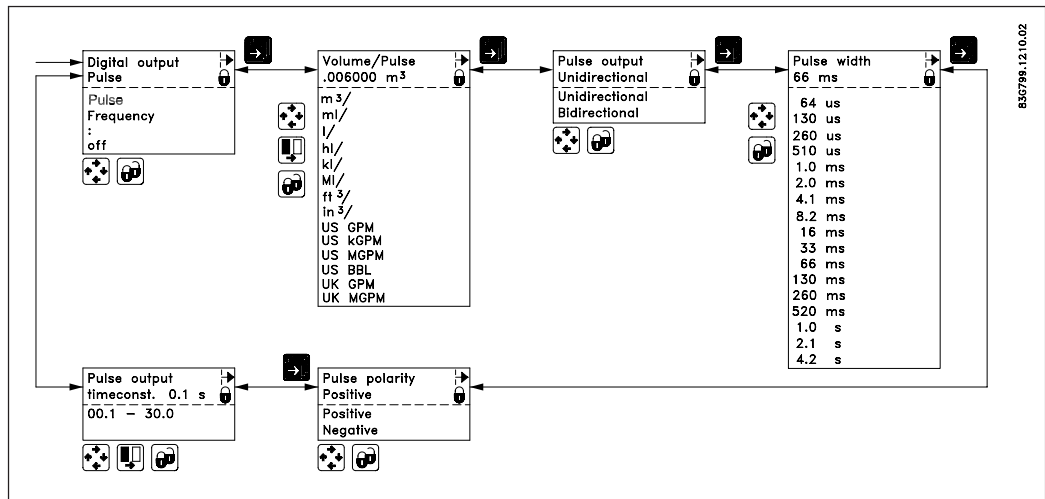

Digital output
Frequency
Proportional to flowrate
(Terminal 56, 57, 58)

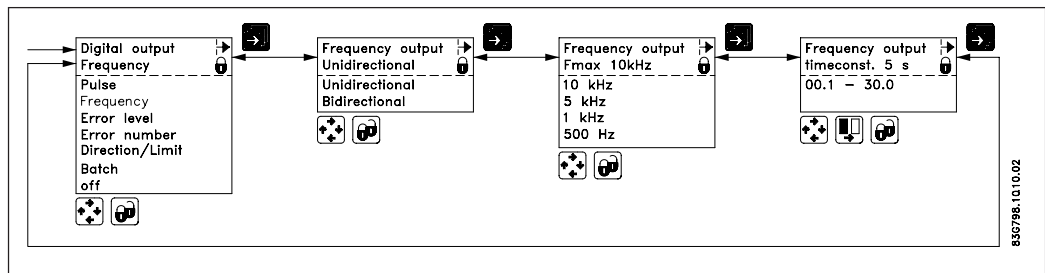

4.3.3 External input

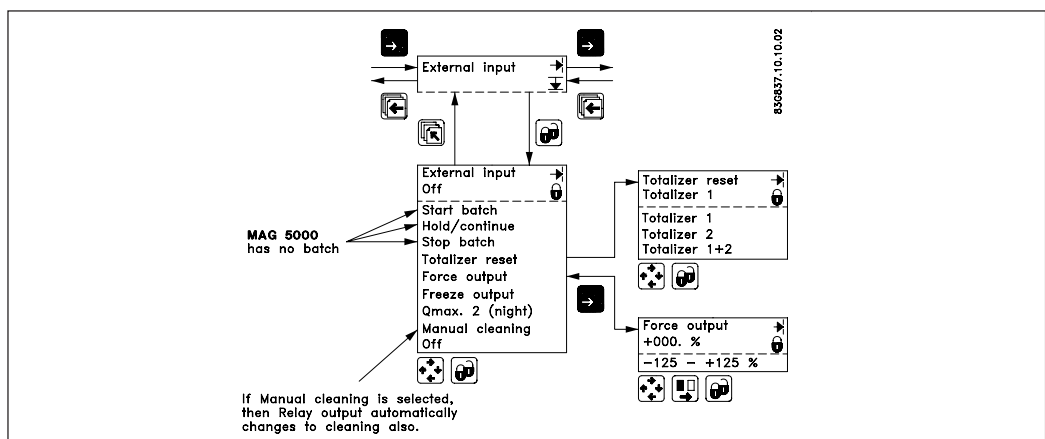

Batch control is available on MAG 6000 only.

4.3.4 Sensor characteristics

If "SENSORPROM not installed" is shown, refer to chapter 6 in the handbook (depending on type of mounting configuration).

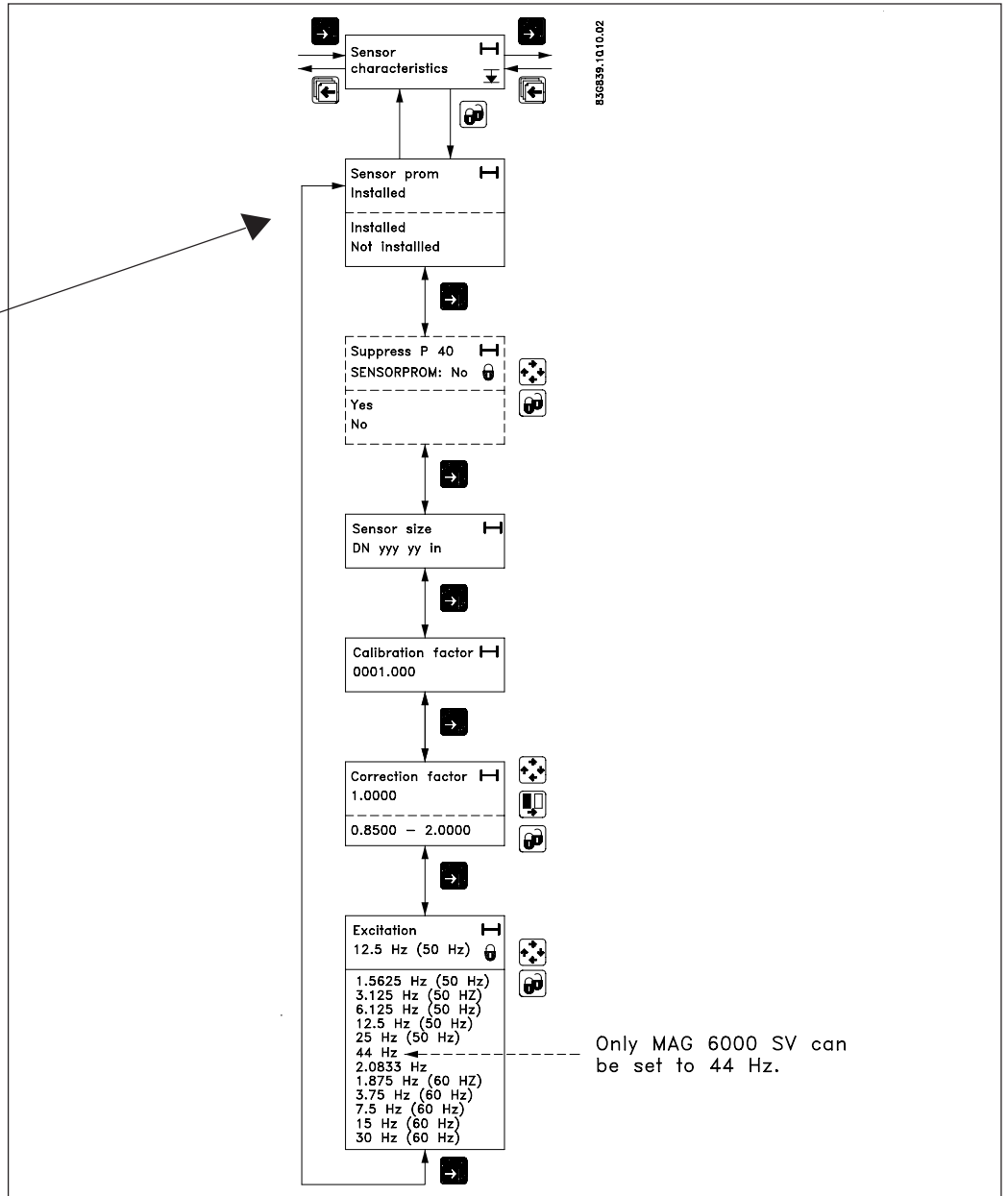

4.3.5 Language mode

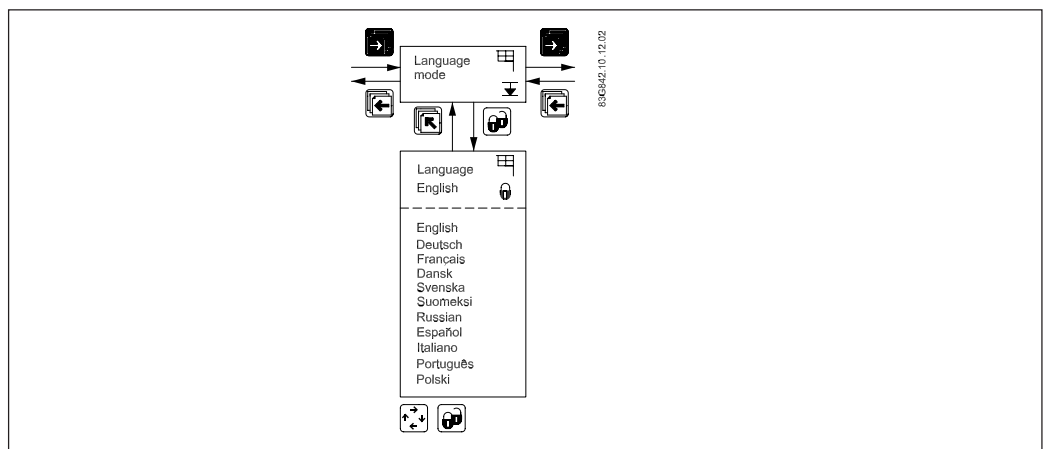

Used to select language.

4.3.6 Service mode

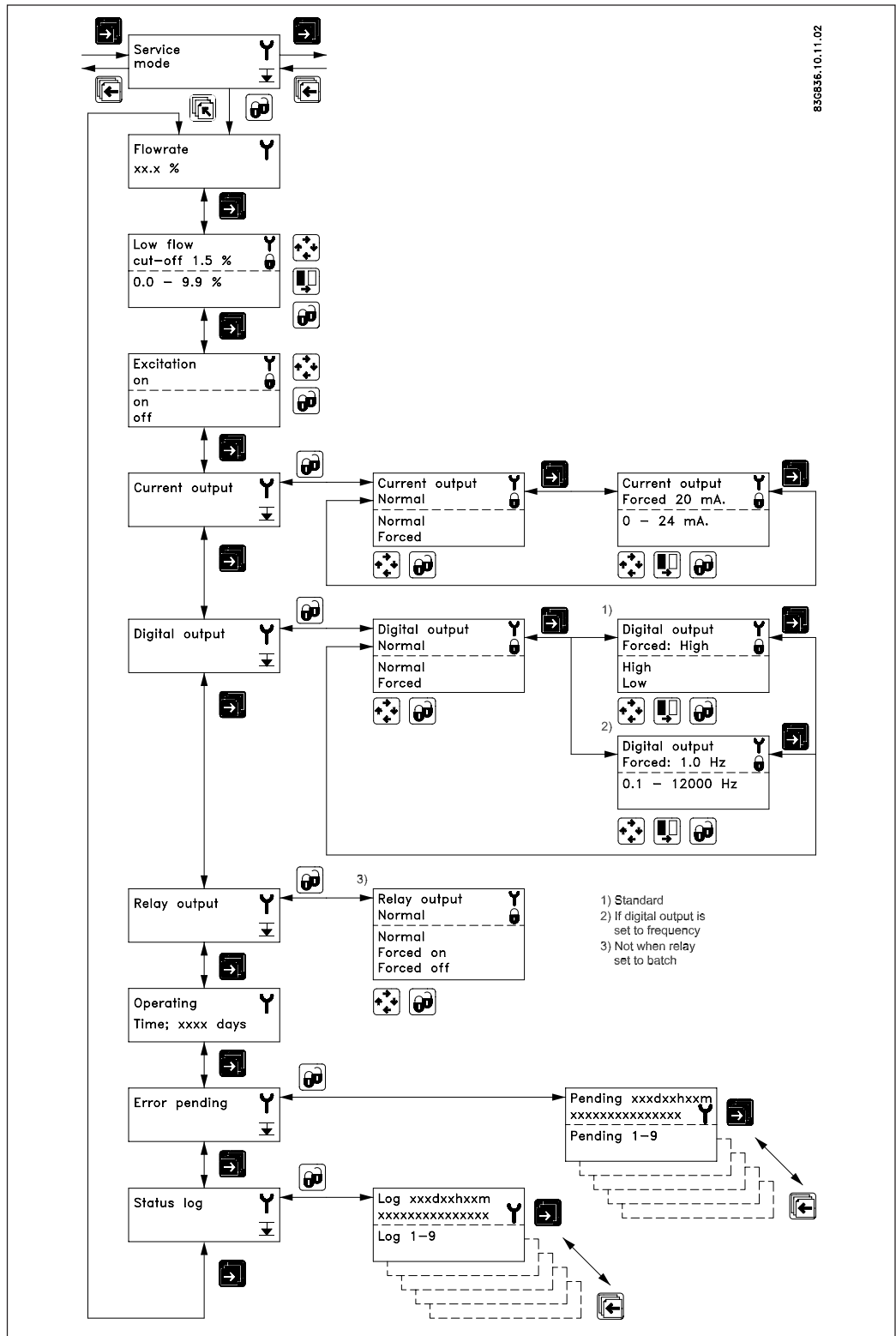

All previous settings are reinitialized when service mode is exited using the top up key .

The error system

The error system is divided into an error pending list and a status log list. Time is displayed as days, minutes and hours since the error has occurred. The first 9 standing errors are stored in error pending. When an error is removed it is removed from error pending. The latest 9 errors are stored in the status log. When an error is removed it is still kept in status log. Errors in status log is stored for 180 days.

Error pending and status log are accessible when enabled in the operator menu.

5. Service

Often problems with unstable/wrong measurements occur due to insufficient/wrong grounding or potential equalization. Please check connection. If OK, the SITRANS F M MAGFLO® transmitter can be checked as described under 9.1 and sensor under 9.3 in the handbook.

5.1 Transmitter check list

When checking SITRANS F M MAGFLO® installations for malfunction the easiest method to check the transmitter is to replace it with another MAG 5000/6000 transmitter with a similar power supply.

A replacement can easily be done as all settings are stored in and downloaded from the SENSORPROM® unit - no extra settings need to be made.

If no spare transmitter is available - then check transmitter according to check table.

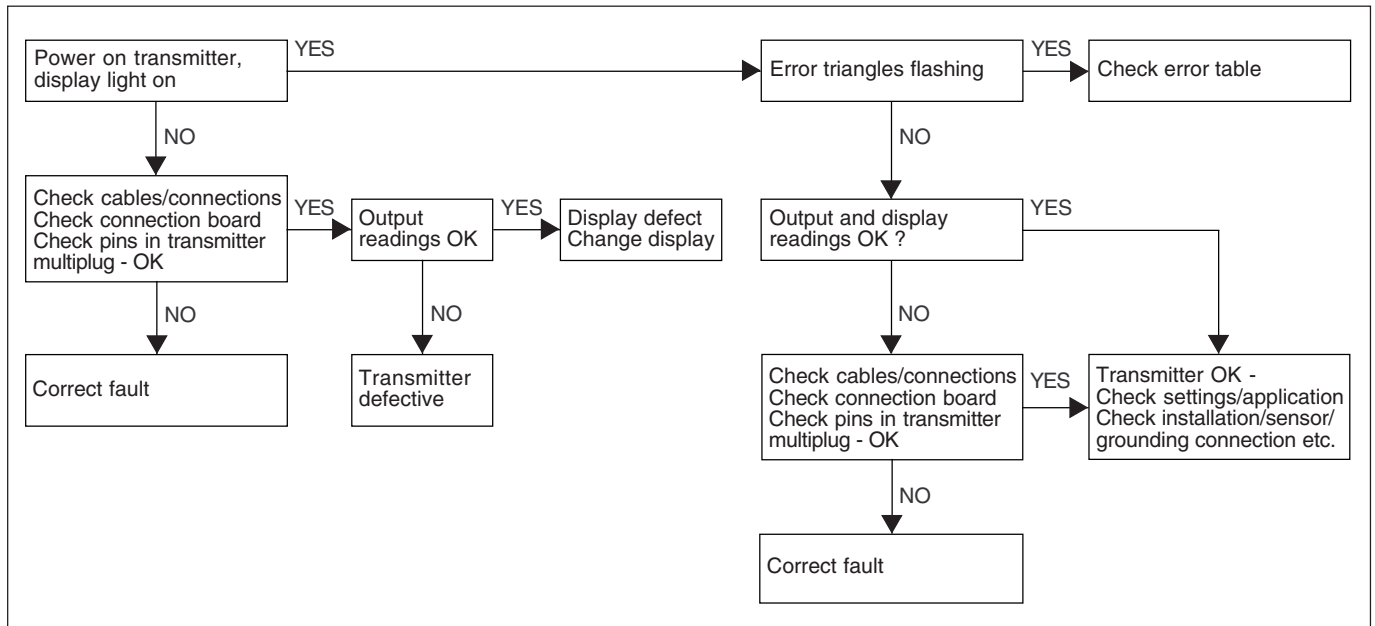

5.2 Trouble shooting
MAG 5000 and MAG
6000

Symptom	Output signals	Error code	Cause	Remedy
Empty display	Minimum		1. No power supply	Power supply Check MAG 5000/6000 for bended pins on the connector
			2. MAG 5000/6000 defective	Replace MAG 5000/6000
No flow signal	Minimum		1. Current output disabled	Turn on current output
			2. Digital output disabled	Turn on digital output
			3. Reverse flow direction	Change direction
			F70 Incorrect or no coil current	Check cables/connections
	Undefined	P42	W31 Measuring pipe empty	Ensure that the measuring pipe is full
			F60 Internal error	Replace MAG 5000/6000
			P41 Initializing error	Switch off MAG 5000/6000, wait 5 s and switch on again
Indicates flow with no flow in pipe	Undefined		Measuring pipe empty	Select empty pipe cut-off
			Empty pipe cut-off is OFF	Ensure that the measuring pipe is full
			Electrode connection missing/ electrode cable is insufficiently screened	Ensure that electrode cable is connected and sufficiently screened
Unstable flow signal	Unstable		1. Pulsating flow	Increase time constant
			2. Conductivity of medium too low	Use special electrode cable
			3. Electrical noise potential between medium and sensor	Ensure sufficient potential equalization
			4. Air bubbles in medium	Ensure medium does not contain air bubbles
			5. High concentration of particles or fibres	Increase time constant
Measuring error	Undefined		Incorrect installation	Check installation
			P40 No SENSORPROM® unit	Install SENSORPROM® unit
			P44 CT SENSORPROM® unit	Replace SENSORPROM® unit or reset SENSORPROM® unit with MAG CT transmitter
			F61 Deficient SENSORPROM® unit	Replace SENSORPROM® unit
			F62 Wrong type of SENSORPROM® unit	Replace SENSORPROM® unit
			F63 Deficient SENSORPROM® unit	Replace SENSORPROM® unit
			F71 Loss of internal data	Replace MAG 5000/6000
	Maximum	W30 Flow exceeds 100% of Q_{max} .	Check Q_{max} . (Basic Settings)	
		W21 Pulse overflow • Volume/pulse too small • Pulse width too large	Change volume/pulse Change pulse width	
Measuring approx. 50%			Missing one electrode connection	Check cables
Loss of totalizer data	OK	W20	Initializing error	Reset totalizer manually
##### Signs in display	OK		Totalizer roll over	Reset totalizer or increase totalizer unit

We have checked the contents of this manual for agreement with the hardware and software described. Since deviations cannot be precluded entirely, we cannot guarantee full agreement. However, the data in this manual are reviewed regularly and any necessary corrections included in subsequent editions. Suggestions for improvement are always welcomed.

Technical data subject to change without prior notice.

The reproduction, transmission or use of this document or its contents is not permitted without express written authority. Offenders will be liable for damages. All rights, including rights created by patent grant or registration of a utility model or design, are reserved.

Copyright © Siemens AG 05.2006 All Rights Reserved