



One Series Explosion Proof Electronic Pressure and Temperature Switches

Discrete Input and Loop-Powered Models: 2X2D, 2X3A, 2X4D, 2XLP

Externally Powered Models: 4X3A, 8X2D



UNITED ELECTRIC
CONTROLS

Installation and Maintenance Instructions

Please read all instructional literature carefully and thoroughly before starting. Refer to the final page for the listing of Recommended Practices, Liabilities and Warranties.

GENERAL

 MISUSE OF THIS PRODUCT MAY CAUSE EXPLOSION AND PERSONAL INJURY. THESE INSTRUCTIONS MUST BE THOROUGHLY READ AND UNDERSTOOD BEFORE UNIT IS INSTALLED. SEE THE PRODUCT NAMEPLATE INFORMATION FOR SPECIFIC AGENCY CERTIFICATIONS APPLICABLE TO YOUR PRODUCT.

 **WARNING:** EXPLOSION HAZARD - SUBSTITUTION OF COMPONENTS MAY IMPAIR SUITABILITY FOR USE IN HAZARDOUS LOCATIONS.



 **WARNING:** FOR ZONE HAZARDOUS LOCATIONS, ALL CABLE ENTRY DEVICES SHALL BE CERTIFIED IN TYPE OF EXPLOSION PROTECTION FLAMEPROOF ENCLOSURE "d" WITH AN IP66 RATING, SUITABLE FOR THE CONDITIONS OF USE AND CORRECTLY INSTALLED. IF CABLES AND CABLE GLANDS ARE NOT USED, A STOPPING BOX SHALL BE PROVIDED WITHIN 2" OF THE ENCLOSURE. FLAMEPROOF JOINT AND GAP DETAILS ARE PROVIDED ON PAGE 16.

THIS EQUIPMENT IS SUITABLE FOR USE IN NON-HAZARDOUS LOCATIONS AND THE FOLLOWING HAZARDOUS LOCATIONS:

-  Class I, Div. 1, GRPS A, B, C, D
 - Class II, Div. 1, GRPS E, F, G
 - Class III
 - Class I, Zone 1, AEx d IIC T5/T3*
 - Class I, Zone 1, Ex d IIC T5/T3*
 - Enclosure Type 4X, IP66
 - 2X2D, 2X3A, 2X4D: $-40^{\circ}\text{C} \leq T_{\text{AMB}} \leq 85^{\circ}\text{C}$ (-40°F TO 185°F)
 - 2XLP, 8X2D: $-40^{\circ}\text{C} \leq T_{\text{AMB}} \leq 80^{\circ}\text{C}$ (-40°F TO 176°F)
 - 4X3A: $-40^{\circ}\text{C} \leq T_{\text{AMB}} \leq 70^{\circ}\text{C}$ (-40°F TO 158°F)
- * Straight pressure sensor models 10-16 have a temperature class of T3, all others T5.

 **WARNING:** EXPLOSION HAZARD – CONDUITS MUST BE SEALED WITHIN 2" OF ENCLOSURE.

THIS EQUIPMENT IS ATEX CERTIFIED SUITABLE FOR APPROPRIATE USE IN GAS ZONE 1 & DUST ZONE 21 APPLICATIONS.

-  DEMKO 09 ATEX 0813748X
 - II 2 G Ex d IIC T5/T3*
 -  II 2 D Ex tD A21 IP66 T90°C
 - 2X2D, 2X3A, 2X4D: $-40^{\circ}\text{C} \leq T_{\text{AMB}} \leq 85^{\circ}\text{C}$
 - 2XLP, 8X2D: $-40^{\circ}\text{C} \leq T_{\text{AMB}} \leq 80^{\circ}\text{C}$
 - 4X3A: $-40^{\circ}\text{C} \leq T_{\text{AMB}} \leq 70^{\circ}\text{C}$
- * Straight pressure sensor models 10-16 have a temperature class of T3, all others T5.

THIS EQUIPMENT IS IECEx CERTIFIED, SUITABLE FOR APPROPRIATE USE IN GAS ZONE 1 APPLICATIONS.

- IECEx UL 08.0017
 - Ex d IIC T5/T3*
 - 2X2D, 2X3A, 2X4D: $-40^{\circ}\text{C} \leq T_{\text{AMB}} \leq 85^{\circ}\text{C}$ (-40°F TO 185°F)
 - 2XLP, 8X2D: $-40^{\circ}\text{C} \leq T_{\text{AMB}} \leq 80^{\circ}\text{C}$ (-40°F TO 176°F)
 - 4X3A: $-40^{\circ}\text{C} \leq T_{\text{AMB}} \leq 70^{\circ}\text{C}$ (-40°F TO 158°F)
- * Straight pressure sensor models 10-16 have a temperature class of T3, all others T5.

MOUNTING

Tools Required: Screwdriver for mounting bolts; 4 mounting bolts (1/4" Max.)

NOTE: optional surface and pipe mounting kit - order part no. 6361-704. See page 21.



BEFORE INSTALLING, CHECK THE SENSOR MODEL SELECTED FOR COMPATIBILITY TO THE PROCESS MEDIA IN CONTACT WITH THE SENSOR AND WETTED PARTS.



IN ALL APPLICATIONS, SECURE THE ENCLOSURE AS DETAILED BELOW. DO NOT MOUNT VIA THE PROCESS CONNECTION ONLY.

Mount the unit using the four (4) 1/4" clearance holes in the enclosure base. Plumb sensor to the process port. See page 21 for dimensions. The One Series product may be mounted in any position except with the sensor connection facing up. Ensure the process connection is sealed to the process port to prevent leakage. Care should be taken to minimize effects of shock and vibration. The One Series should be protected from direct sunlight and rain in outdoor installations using a shroud. **NOTE:** the optimal display viewing position is 6:00.



FOR PRESSURE AND LOCAL TEMPERATURE MODELS ALWAYS HOLD A WRENCH ON THE SENSOR HEX WHEN MOUNTING UNIT. DO NOT TIGHTEN BY TURNING ENCLOSURE, THIS WILL DAMAGE THE CONNECTION BETWEEN THE SENSOR AND HOUSING.



INSTALL UNITS WHERE SHOCK, VIBRATION AND TEMPERATURE FLUCTUATIONS ARE MINIMAL. ORIENT UNIT TO PREVENT MOISTURE FROM ENTERING ENCLOSURE. USE PROPERLY RATED SEALING FITTINGS FOR ELECTRICAL WIRE ENTRY. DO NOT MOUNT UNIT IN AMBIENT TEMPERATURES EXCEEDING PUBLISHED LIMITS. THIS IS ESPECIALLY CRITICAL FOR LOCAL MOUNT TEMPERATURE UNITS. USE OF A SHROUD IS RECOMMENDED WHERE DIRECT SUNLIGHT AND RAIN MAY COME IN CONTACT WITH THE ENCLOSURE.



FOR DIFFERENTIAL PRESSURE MODELS (ESPECIALLY LOW RANGE UNITS), CARE SHOULD BE TAKEN TO MOUNT THE SENSOR LEVEL TO MINIMIZE ANY PRESSURE READING OFFSETS. THE OFFSET COMMAND MAY BE USED TO ZERO THE DISPLAY, SEE PAGE 12 FOR ADDITIONAL INFORMATION.

PROCESS CONNECTIONS AND SENSOR INSTALLATION



WARNING: NEVER INSERT ANY OBJECT INTO THE PRESSURE SENSOR OPENING. DAMAGE TO THE SENSOR WILL RESULT, AFFECTING ACCURACY.

Pressure and Differential Pressure Models

To pipe mount: Thread the pressure connection onto the pressure port, with thread sealant, making sure that the mating threads are clean and free of debris. Use a wrench on the pressure connection hex to tighten. Test for leaks. On Differential Pressure models, the Low (L) side pressure must NOT exceed the high (H) side pressure.

Local and Remote Temperature Models

For Local Ambient Sensing (model L): Mount using the mounting holes on the electronics housing. Mount the product to ensure that the sensor housing will not be damaged and where the measured temperature is representative of the surrounding environment.

For Local Spring-Loaded (model T): A suitable thermowell, made from corrosion-resistant material, 5 threads engaged minimum, with thread sealant, is required to maintain enclosure type 4X/IP66.

For Remote Sensing: Route the extension wire to avoid contact with live components or close proximity to electrical noise sources. Avoid kinks, or excessive flexing. Tighten the ferrule fitting, if applicable.

For Surface Sensing: Secure the sensor housing to the pipe or vessel using an adhesive or strapping method suitable for the application.

For Immersion Sensing (models C, H, R & L): Use of a thermowell is highly recommended to aid in maintenance, testing and preservation of the system integrity. Insert the sensor housing (0.25" diameter) into the well ensuring that the housing bottoms out and the well is completely immersed in the media (2.5" min.) Screw the sensor's nipple into the thermowell, with thread sealant, by placing a wrench on the union nut. Adjust the position of the One Series display for convenient viewing. Tighten the union connector.

For best temperature measurements, the sensor housing must be in full contact with the surface or media being measured. Heat transfer compound may be used to aid in fully transferring the media temperature to the sensor housing. Locate where the temperature is most representative of the system. Minimum insertion depth is 2-1/2". Sensor dimensional drawings are shown on page 22.



For User Installed Temperature Sensors (Models TU):

Explosion-proof rated temperature sensor assemblies may be installed per the following; 100 Ohm Platinum 4-wire RTD DIN 0.00385, 1/2" NPT male connection to housing, 5 threads engaged minimum for cULus, ATEX & IECEx requirements. Grease required on threads.

UL approval of this product applies to the enclosure and internal circuitry only. In order to maintain explosion-proof protection, the installer must connect the product to a suitable explosion-proof temperature sensor, certified to the same gas and dust groups, rated for the same ambient range and made from a corrosion-resistant material.

WIRING

Tools Required: Small flat-head screwdriver; wire strippers



WARNING: EXPLOSION HAZARD - TO PREVENT IGNITION, DISCONNECT POWER BEFORE REMOVING ENCLOSURE COVER. KEEP COVER TIGHT WHILE IN OPERATION. DO NOT DISCONNECT EQUIPMENT UNLESS POWER HAS BEEN SWITCHED OFF OR THE AREA IS KNOWN TO BE NON-HAZARDOUS.



WARNING: EXPLOSION HAZARD - DO NOT REPLACE COMPONENTS UNLESS POWER HAS BEEN SWITCHED OFF OR THE AREA IS KNOWN TO BE NON-HAZARDOUS.



THE DEVICES SHALL BE PROPERLY GROUNDED IN THE END USE APPLICATION USING THE GROUND SCREWS PROVIDED WITH THE ENCLOSURE.



FIELD WIRING MUST BE RATED 105°C MINIMUM. FOR AMBIENT TEMPERATURES BELOW -10°C, USE SUITABLE FIELD WIRING.



MODEL 2X2D ACCEPTS 12-30 VDC AND MODEL 2X4D ACCEPTS 30-50 VDC AS ITS POWER SOURCE, DIRECTLY FROM A PLC/DCS DISCRETE INPUT OR OTHER LOW-POWER DC LOADS. THE SWITCHED OUTPUT MAXIMUM LOAD RATING IS 40 mA. **THE UNIT MUST NOT BE CONNECTED DIRECTLY TO A POWER SUPPLY WITHOUT AN APPROPRIATE CURRENT LIMITING LOAD SUCH AS THAT PROVIDED BY A PLC/DCS DISCRETE INPUT. OVERLOADING THE SWITCH MAY CAUSE FAILURE.**



MODEL 2X3A ACCEPTS 90-130 VAC/VDC AS ITS POWER SOURCE, DIRECTLY FROM A PLC/DCS DISCRETE INPUT OR OTHER LOW-POWER LOADS. THE SWITCHED OUTPUT MAXIMUM LOAD RATING IS 100 mA. **THE UNIT MUST NOT BE CONNECTED DIRECTLY TO A POWER SUPPLY WITHOUT AN APPROPRIATE CURRENT LIMITING LOAD SUCH AS THAT PROVIDED BY A PLC/DCS DISCRETE INPUT. OVERLOADING THE SWITCH MAY CAUSE FAILURE.**



MODEL 2X4D ACCEPTS 30-50 VDC AS ITS POWER SOURCE, DIRECTLY FROM A PLC/DCS DISCRETE INPUT OR OTHER LOW-POWER LOADS. THE SWITCHED OUTPUT MAXIMUM LOAD RATINGS IS 40 mA. **THE UNIT MUST NOT BE CONNECTED DIRECTLY TO A POWER SUPPLY WITHOUT AN APPROPRIATE CURRENT LIMITING LOAD SUCH AS THAT PROVIDED BY A PLC/DCS DISCRETE INPUT. OVERLOADING THE SWITCH MAY CAUSE FAILURE.**



MODEL 2XLP IS LOOP-POWERED AND OBTAINS POWER FROM THE 4-20 mA LOOP. THE MAXIMUM LOAD RATING FOR EACH SWITCH IS SHOWN IN THE TABLE ON PAGE 9, ALONG WITH DERATING SPECIFICATIONS. **OVERLOADING THE SWITCH MAY CAUSE FAILURE. THE SWITCH MUST NOT BE CONNECTED DIRECTLY TO A POWER SUPPLY WITHOUT A SUITABLE LOAD.**



MODEL 4X3A ACCEPTS 90-130 VAC/VDC AS ITS POWER SOURCE. THE MAXIMUM LOAD RATING FOR EACH SWITCH IS SHOWN IN THE TABLE ON PAGE 9, ALONG WITH DERATING SPECIFICATIONS. **OVERLOADING THE SWITCH MAY CAUSE FAILURE.**



THE ONE SERIES 8X2D MODEL ACCEPTS 12-30 VDC AS ITS POWER SOURCE. THE MAXIMUM LOAD RATING FOR EACH SWITCH IS SHOWN IN THE TABLE ON PAGE 9, ALONG WITH DERATING SPECIFICATIONS. **OVERLOADING THE SWITCH MAY CAUSE FAILURE.**

Removing the One Series Enclosure Cover and Display Module



WARNING: Disconnect all supply circuits before attempting to wire the unit. Wiring must be performed according to national and local electrical codes. Maximum recommended wire sizes and tightening torques for field wiring terminal blocks are shown below.

Remove the enclosure cover by turning it counter-clockwise for 7 revolutions. Carefully remove the display module by grasping the outer edge and pulling it away from the base enclosure, being careful not to strain any of the wired connections. Allow the display module to hang from the wired connections to access the base enclosure and terminal blocks for wiring. Do not remove the display module wire assemblies. Insert the field wiring through the conduit opening(s) of the base enclosure. Make the connections as shown on the wiring diagrams beginning on Page 4. **The primary chassis and equipment grounding terminal** is provided inside the base enclosure.

To prevent seizure of the enclosure cover, do not remove thread lubricant. Threads should be kept free of dirt and other contaminants. Cleaning the display and keypad surface should be performed with a damp cloth only. Do not attempt to wash down the One Series with the cover removed.



Terminal Block and Torque Details

2X2D, 2X3A, 2X4D, 4X, 8X

	Description	Max. Wire Gauge	Min. Wire Gauge	Recommended Tightening Torque
TB1	3-Position	14 AWG	22 AWG	7 in-lbs.
TB2	4-Position	10 AWG	20 AWG	4.4 in-lbs.
TB3	6-Position	16 AWG	26 AWG	2.2 in-lbs.

	Description	Max. Wire Gauge	Min. Wire Gauge	Recommended Tightening Torque
TB1	3-Position	14 AWG	22 AWG	3.48 in-lbs.
TB2	2-Position	14 AWG	26 AWG	4.4 in-lbs.

NOTE: The sensor wiring harness must remain connected to the display module with the red wire oriented to the arrow on the label. Reversing this connector will result in measurement errors or failure.

WIRING DIAGRAMS - MODEL 2X2D/2X4D
(Use Class 2 or SELV Power Supply Only)

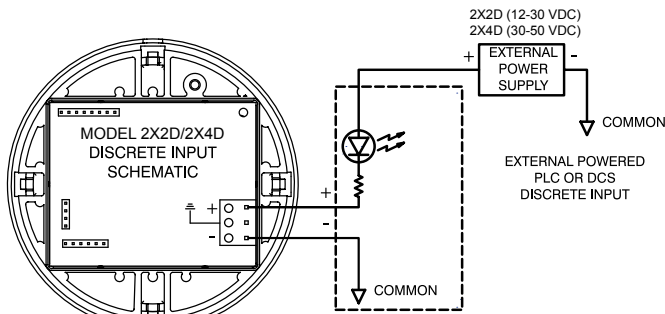

FIGURE 1

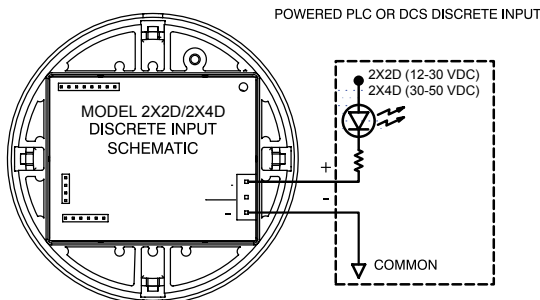

FIGURE 2

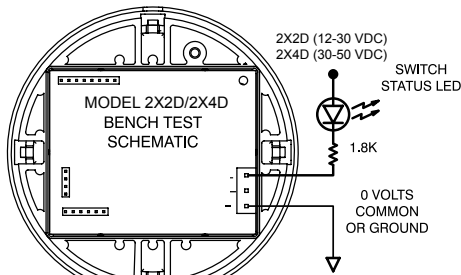

FIGURE 3

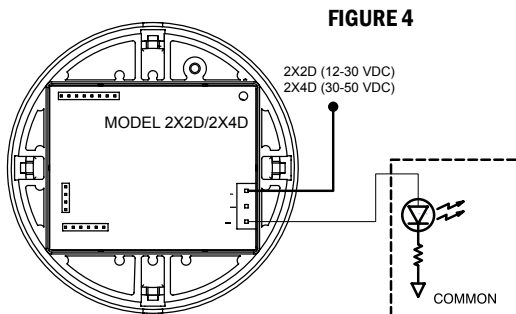

FIGURE 4

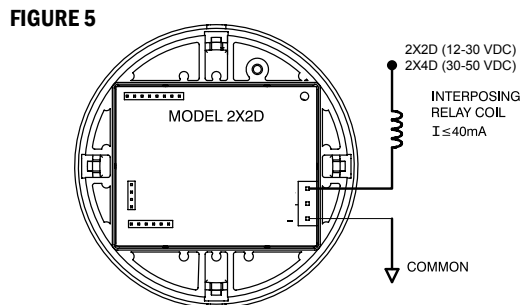



FIGURE 5

Model 2X2D/2X4D is intended for direct connection to a PLC or DCS discrete input, or other suitable load (see page 15). Power is obtained and the discrete switch signal is provided by the same two-wire connection. Polarity must be observed. Refer to the Switch Ratings Table for the switch ratings. **Do not connect model 2X2D or 2X4D directly to a power supply without a suitable load in series with the switch.**

 For 2X2D/2X4D models, only one conduit opening is required. The unused conduit opening must include an explosion-proof/flameproof plug, made from a corrosion-resistant material, suitable for all gas and dust groups as listed on the nameplate. Blanking elements from factory have been tested with the enclosure as an assembly and carry no markings.

These circuit diagrams provide a rear view of the display module after it has been removed from the base enclosure.

Figures 1, 2 and 4 show typical wiring schemes depicting model 2X2D/2X4D connected to a programmable logic controller (PLC), distributed control system (DCS) or other logic solver discrete input. The circuits shown inside a dotted line box next to the display module are part of the discrete input and are not required to complete the wiring.

NOTE: For bench testing model 2X2D/2X4D, a circuit is required as shown in Figure 3. These components are not included and must be provided by the tester. **Do not connect model 2X2D/2X4D directly to a power supply without a suitable load in series with the switch.**

Model 2X2D/2X4D can also be wired in series with the coil of certain interposing relays, as shown in Figure 5. The relay coil specifications must not exceed the maximum switch ratings of model 2X2D/2X4D.

NOTE: Model 2X2D has a maximum switch rating of 30 VDC @ 40 mA and model 2X4D has a maximum switch rating of 50 VDC @ 40 mA. Do not exceed this rating or permanent damage may result.

WIRING DIAGRAMS - MODEL 2X3A

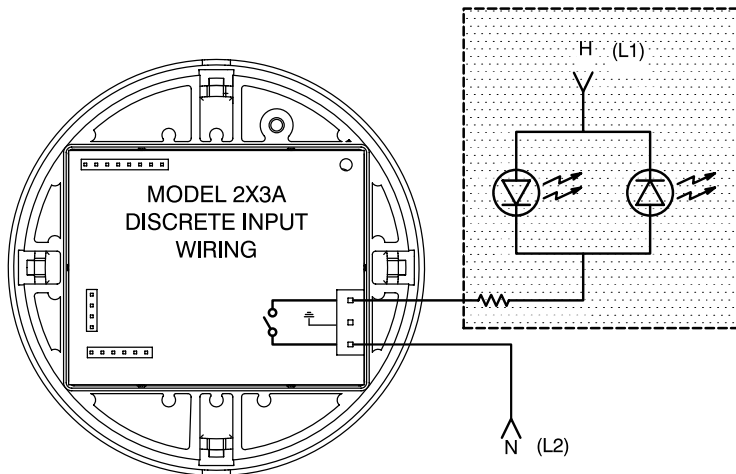

FIGURE 1

PLC OR DCS
120 VAC
DISCRETE INPUT

Model 2X3A is intended for direct connection to a 115 VAC PLC or DCS discrete input, or other suitable load (see page 15). Power is obtained and the discrete switch signal is provided by the same two-wire connection. Model 2X3A is a non-polarized switch and may be used in VDC circuits. Refer to the Switch Ratings Table for the switch ratings. **Do not connect model 2X3A directly to a power supply without a suitable load in series with the switch.**



For 2X3A models, only one conduit opening is required. The unused conduit opening must include an explosion-proof/flameproof plug, made from a corrosion-resistant material, suitable for all gas and dust groups as listed on the nameplate. Blanking elements from factory have been tested with the enclosure as an assembly and carry no markings.

These circuit diagrams provide a rear view of the display module after it has been removed from the base enclosure.

Figure 1 shows a typical wiring scheme for when model 2X3A is connected to a programmable logic controller (PLC), distributed control system (DCS) or other logic solver discrete input. The circuit shown inside the dotted line box next to the display module is part of the discrete input and is not required to complete the wiring.

NOTE: For bench testing model 2X3A, a suitable load resistor is required and included as shown in Figure 2. **Do not connect model 2X3A directly to a power supply without a suitable load in series with the switch.**

Model 2X3A can also be wired in series with the coil of certain interposing relays, as shown in Figure 3. The relay coil specifications must not exceed the maximum switch ratings of model 2X3A.

NOTE: **Model 2X3A** has a maximum switch rating of 130 VAC and VDC @ 100 mA. Do not exceed this rating or permanent damage to the One Series may result.

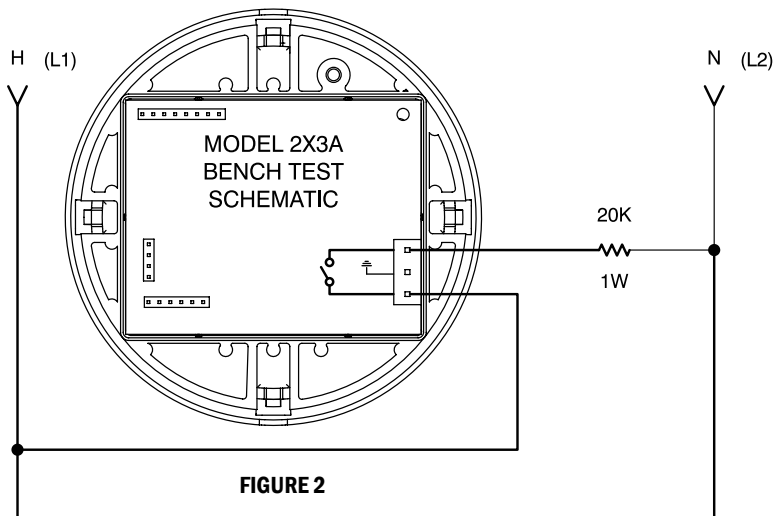

FIGURE 2

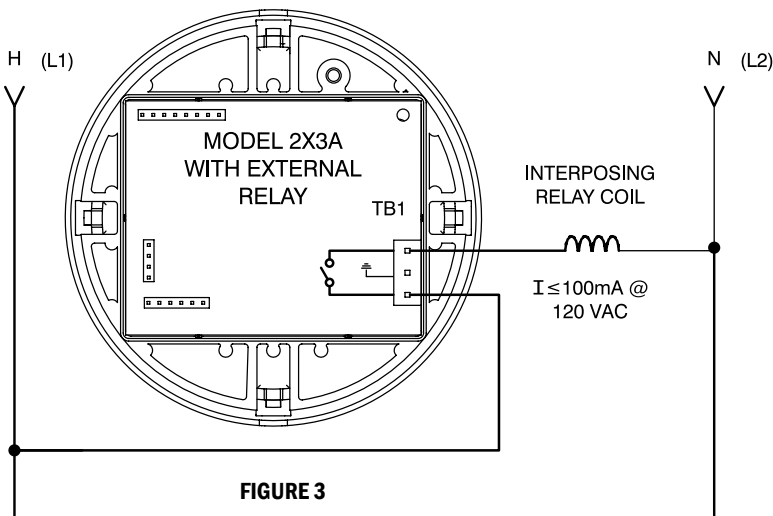

FIGURE 3

WIRING DIAGRAMS - MODEL 2XLP

Model 2XLP is loop-powered and is connected directly to an analog input of a PLC or DCS via TB2 providing a 4-20 mA analog signal (see page 15). Polarity must be observed. The loop connection powers the entire One Series, including the solid-state relay switch actuation. The auxiliary solid-state relay is connected via TB1 and is intended to switch an external load. Refer to the Switch Ratings Table on page 9 for the solid-state relay switch ratings.

These circuit diagrams provide a rear view of the display module after it has been removed from the base enclosure.



Unit comes with two open conduits, one intended for power wiring and the other intended for signal wiring.

Figure 1 shows a typical wiring scheme for when model 2XLP is connected to a programmable logic controller (PLC), distributed control system (DCS) or other logic solver analog input that provides loop power. The circuit shown inside the dotted line box next to the display module is part of the analog input and is not required to complete the wiring.

For model 2XLP, Figure 2 shows an external power supply used to provide loop power and switched load power using an internal jumper to simplify wiring. In this application, both an analog and a discrete (switched) signal is connected to the PLC.

Model 2XLP can also be wired in series with the coil of certain interposing relays. The relay coil specifications must not exceed the maximum switch ratings of the 2XLP model chosen. Refer to the Switch Ratings Table for the solid-state relay switch ratings.

As an alternative to loop power, Figure 3 shows model 2XLP wired directly to a power supply. This wiring scheme provides power for all model 2XLP functions, but a 4-20 mA output is not possible.

NOTE: Do not exceed the maximum switch ratings or permanent damage to the One Series may result. Refer to the Switch Ratings Table on page 9 for the solid-state relay switch ratings.

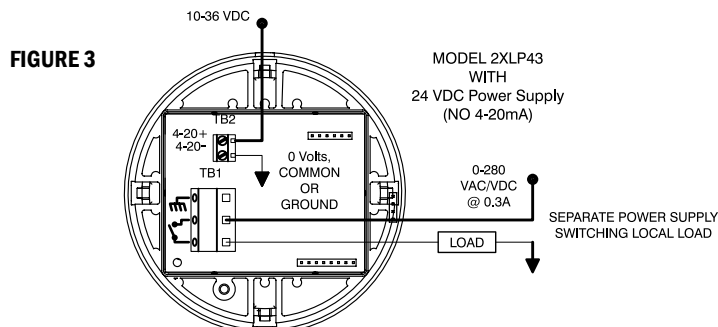
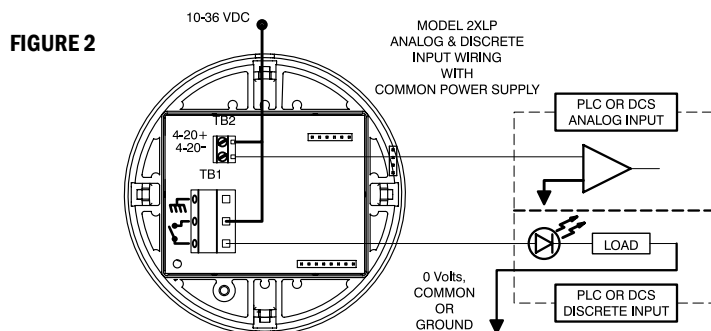
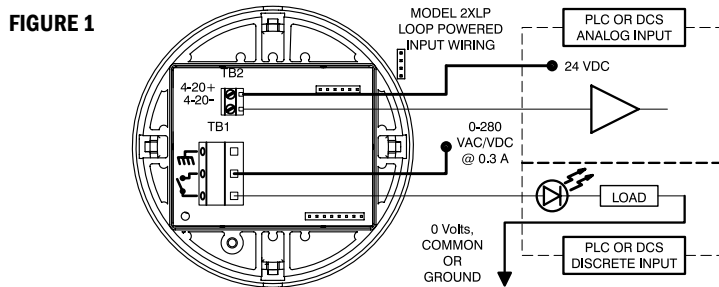

WIRING DIAGRAMS - MODEL 4X3A

Model 4X3A requires a 90-130 VAC @ 15 mA external power supply. Power for all functions is provided from the power supply connection to TB2 C (L1) and D (L2) terminals. Connections to the solid-state relay are made at TB2 using the A and B terminals. Refer to the Switch Ratings Table for the switch ratings.

These circuit diagrams provide a view inside the One Series base enclosure after the display module has been removed. No user wiring connections to the display module are required for model 4X3A.



Unit comes with two open conduits, one intended for power wiring and the other intended for signal wiring.

Figure 1 shows a typical 3-wire wiring scheme for model 4X3A where only three wires are required. This assumes that the One Series power supply and the load power supply are the same (common). An internal jumper is required for this wiring scheme, as shown between terminals B and C on TB 2.

Figure 2 shows a typical 4-wire wiring scheme for model 4X3A. One power supply is used for instrument power and a separate (isolated) power supply is used for the load. No jumper is required for this 4-wire configuration.

NOTE: The solid-state relay used in model 4X3A has a minimum load requirement of 150 mA, making it incompatible with logic solver discrete inputs. For these types of inputs, choose another One Series model.

NOTE: Do not exceed the maximum switch ratings or permanent damage to the One Series may result. Refer to the Switch Ratings Table on page 9 for the solid-state relay switch ratings.

FIGURE 1

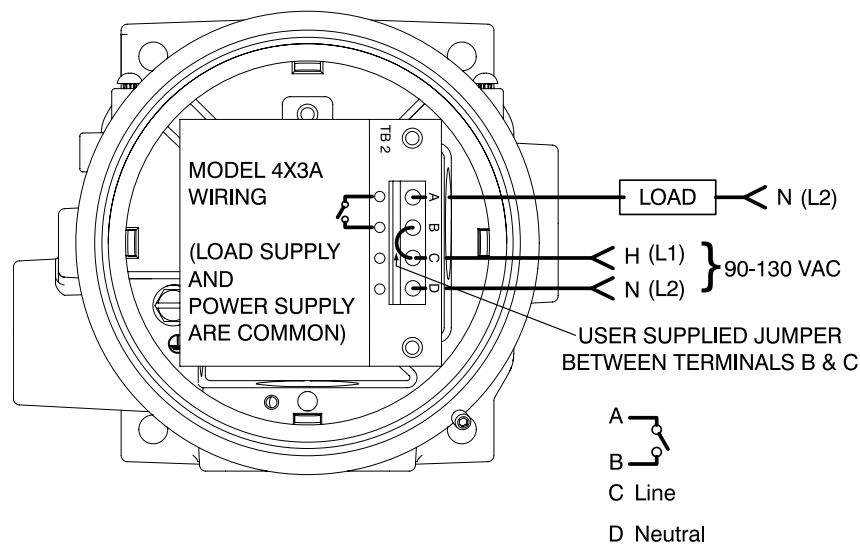
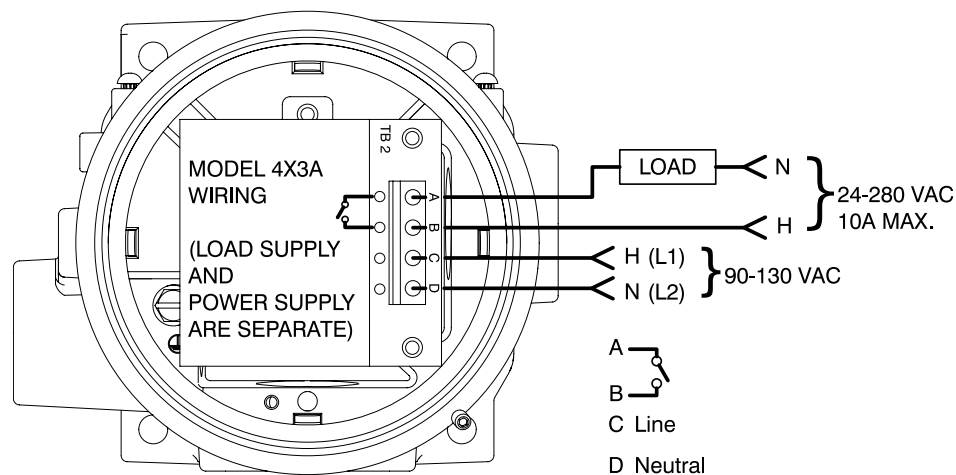

FIGURE 2



WIRING DIAGRAMS - MODEL 8X2D

Model 8X2D requires a 12-30 VDC @ 30 mA external power supply and includes two solid-state relays and a 4-20 mA output. All of these components are electrically isolated and can be wired independently, requiring 8 connections.

Figures 1-3 show the various wiring terminal blocks as they appear on the display module (rear) and inside the base enclosure. The sensor cable and the 8-conductor ribbon cable must remain connected to the display module.



Unit comes with two open conduits, one intended for power wiring and the other intended for signal wiring.

Power Supply: Connect the leads from an external power supply to the + and – terminals of TB1 on the back of the display module, observing polarity.
(Use Class 2 or SELV power supply only)

Solid-state relays: Connect the two solid-state relays at TB2 to appropriate loads. Switch 1 (SW1) connections are located at terminals A & B on TB 2. Switch 2 (SW2) connections are located at terminals C & D on TB2. See Figure 4. Refer to the Switch Ratings Table on page 9 for SW1 & SW2 ratings. Do not exceed the maximum switch ratings or permanent damage to the One Series may result. Use of the solid-state relays is optional.

Analog output: Connect the 4-20 mA output leads at TB3 using the + and – terminals. The analog output can be wired for a sinking or sourcing 4-20 mA output (see Figures 2 & 3). The 4-20 mA output in model 8X2D is not self-powered. 24 VDC must be provided. This can be accomplished by using a jumper between TB1 + terminal and TB3 + terminal. The analog output is then available at TB3 – terminal, as shown in Figure 3. Use a separate power supply if isolation from the main supply is desired. Use of the analog output is optional.

NOTE: For model 8X2D45, providing a jumper between TB1 + terminal, TB2 terminals A & C and TB3 + terminal allows the use of a single (common) power supply for all loads and the 4-20 mA output. This will greatly simplify wiring, assuming both switch loads are 24 VDC.

NOTE: The solid-state relays used in model 8X2D42 and SW1 in model 8W2D44 have a minimum load requirement of 50 mA, making it incompatible with logic solver discrete inputs. For these types of inputs, choose another One Series model.

NOTE: Do not exceed the maximum switch ratings or permanent damage to the One Series may result. Refer to the Switch Ratings Table on page 9 for the solid-state relay switch ratings.

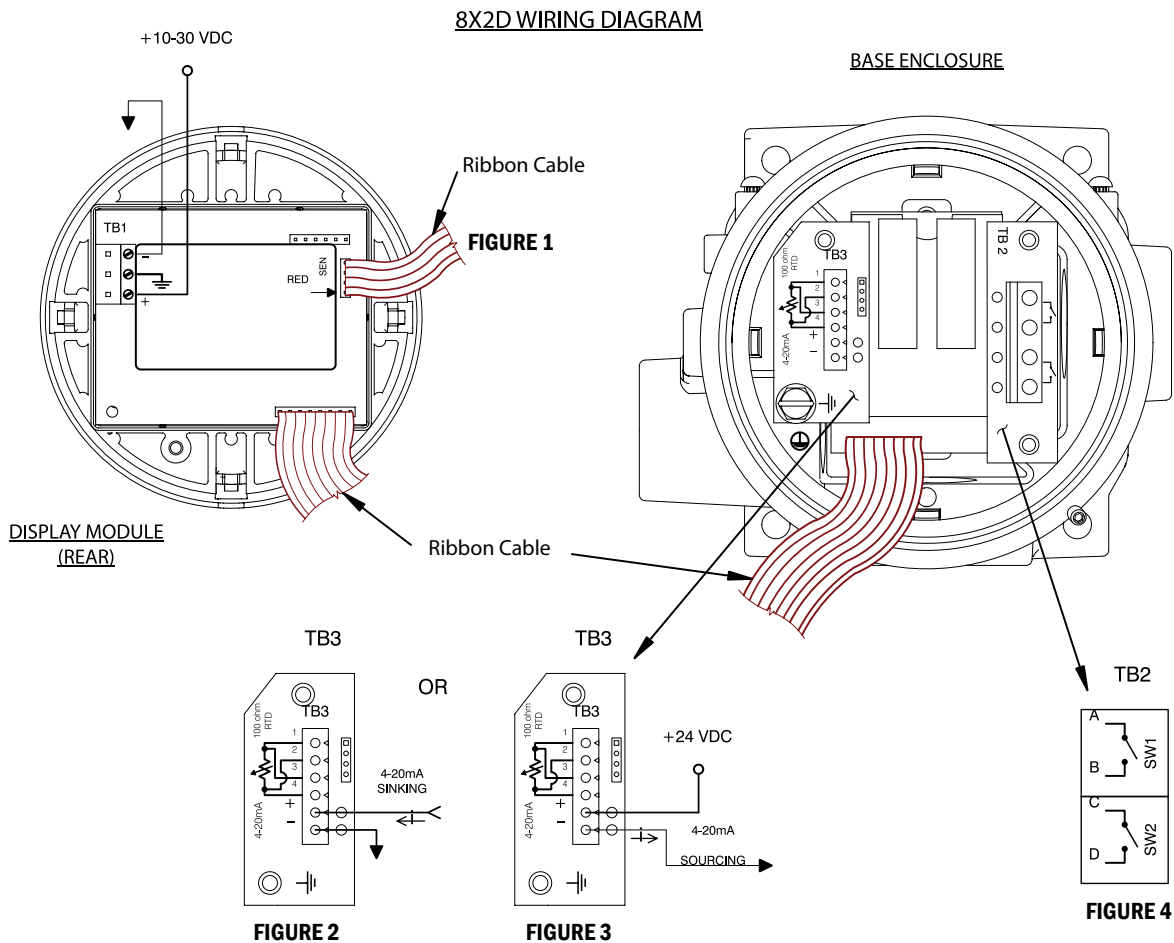

WIRING DIAGRAMS - TU1-TU3

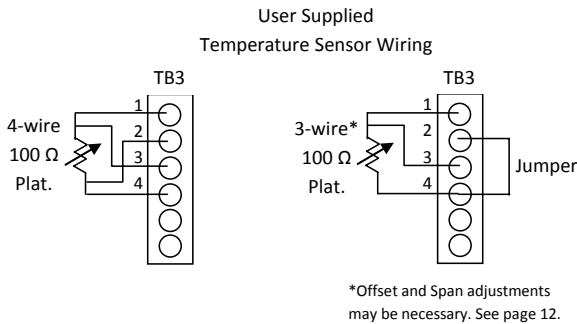

Switch Ratings Table		
Model Number	SW1	SW2
2X2D00	12-30 VDC @ 40 mA	N/A
2X4D00	30-50 VDC @ 40 mA	N/A
2X3A00	90-130 VAC/VDC @ 100 mA	N/A
2XLP41	0-140 VAC/VDC @ 0.6 A ¹	N/A
2XLP43	0-280 VAC/VDC @ 0.3 A ¹	N/A
4X3A01	24-280 VAC @ 10 A ²	N/A
8X2D42	75-250 VAC @ 1.5 A ³	75-250 VAC @ 1.5 A ³
8X2D44	75-250 VAC @ 1.5 A ³	0-140 VAC/VDC @ 0.6 A ¹
8X2D45	0-140 VAC/VDC @ 0.6 A ¹	0-140 VAC/VDC @ 0.6 A ¹
Warning: Exceeding the current or voltage ratings could damage the One Series		

¹ Derate at 8% per 10°C (18°F)

² Derate at 1 A per 10°F (5.5°C) for temperature above 100°F (38°C)

³ Derate at 10% per 10°C (18°F) (Subject to change)

THEORY OF OPERATION

The One Series electronic switch product line is based on an all-solid-state electronic module that incorporates a microprocessor. The combination of features like no moving parts and IAW[®] self-diagnostics provide a highly reliable, accurate and repeatable monitor for detecting pressure and temperature thresholds and, once reached, can make intelligent switch decisions based on retained settings and current conditions. Where a mechanical device has no way of determining its “readiness”, the One Series monitors its own health and reports it locally. This IAW[®] (I Am Working) feature provides a solution to the “blind device” issue common with mechanical apparatus. You will always know the health status of the One Series.

The One Series is also very rugged, featuring a Type 4X, weather-tight enclosure suitable for harsh environments and hazardous (Class I, Division 1) locations. The 0.5% accuracy rating is maintained over a very wide -40°C - (+70°C) operating range using active temperature compensation. Repeatability rivals that of a process transmitter, with a 0.1% of full range rating. The set point and deadband (hysteresis) of the switch is fully programmable over the entire range of the sensor. Reaction time for the One Series to a process change is typically 60 mS or less.

2-WIRE SIMPLICITY (2X Models only)

The One Series 2-Wire electronic pressure switch (patented) is designed to operate on discrete input leakage current (models 2X2D, 2X4D and 2X3A) or analog input 4-20 mA loop power (models 2XLP41 and 2XLP43). The microprocessor-based One Series 2-Wire is the only electronic switch to operate and switch over a single pair of wires, similar to a traditional mechanical switch or 4-20 mA process transmitter. It combines the simplicity and low cost features of a switch and the reliability features of a transmitter, at less than half the price of the transmitter, and without the need to provide additional wiring.

- Model 2X2D is designed to work with most 24 VDC discrete Programmable Logic Controller (PLC) or Distributed Control System (DCS) inputs and some relays. When open, the switch draws 750 µA (max); when closed, the switch sinks or sources 40 mA maximum @ 12-30 VDC.
- Model 2X4D is designed to work with most 48 VDC discrete Programmable Logic Controller (PLC) or Distributed Control System (DCS) inputs and some relays. When open, the switch draws 1 mA (max); when closed, the switch sinks or sources 40 mA maximum @ 30-50 VDC.
- Model 2X3A is designed to work with most 115 VAC discrete PLC or DCS inputs and some relays. When open, the switch draws 1 mA; when closed, the switch sinks or sources 100 mA maximum @ 90-130 VAC or VDC.
- Model 2XLP is loop-powered and operates in a transmitter loop attached to an analog PLC or DCS input and provides a field-scalable 4-20 mA signal over a 2-wire connection. Model 2XLP41 contains an auxiliary solid-state relay switch rated for 0.6 A @ 140 VAC or VDC maximum and requires 2 additional wires, if used. Model 2XLP43 is rated for 0.3 A @ 280 VAC or VDC.

DISPLAY

The One Series features a large, easy-to-read display, showing the process condition and the status of the instrument. (See Display Features for a complete description.) Set point, deadband and minimum/maximum process values can be easily accessed from the front of the unit while in operation. Programming and interrogating the One Series is done through two buttons on the faceplate.

HIGH-POWER AND DUAL SWITCHING

One Series model 4X3A incorporates a relay to provide a high-capacity switch rating of 280 VAC at up to 10 A. One Series model 8X2D provides 2 independent relays (see table above for details) and includes a field-scalable 4-20 mA analog output that is proportional to the process variable. These One Series Models require a separate power supply.

I Am Working (IAW[®])

The One Series also contains UE's patented IAW[®] diagnostic software. On a continuous basis, the One Series is checking itself for proper operation, and letting you know locally that things are OK using revolving arrows on the display. For remote assurance, the output can be set up for 3-state operation, allowing the host device to detect normal, tripped, and fault conditions (see Key Programming Features, page 11 for a full description of the 3-state operation). IAW[®] watches over many possible faults, both within itself and in the overall system (a list of the various parameters is outlined in the chart under Fault Codes, page 14). In the event of a fault condition, the One Series will attempt to display the problem and provide remote electrical indication. In the case of certain micro-controller faults, the revolving arrow may freeze or go out, indicating that a failure exists.

OTHER FEATURES



The One Series has other advanced features:

- When the Plugged Port feature is enabled, the One Series will watch for process conditions which could be evidence of a plugged sensing port or an accidentally-closed instrument valve, and alert the user to potential problems.
- The switch output can be configured for either automatic reset or latching, requiring the user to manually acknowledge the alarm.
- User selectable switch response time (delay) filter allows for dampening the One Series response to process upsets or spikes, eliminating nuisance trips. (See Key Programming Features, page 11 for a complete description of these features).

DISPLAY FEATURES AND DIAGNOSTICS

The One Series features a large, easy to read LCD display. It is used for three main purposes: process indication, programming of key features and switch status/troubleshooting.

In the Process Display mode, the display may be indicating the following:

- Current process value and units of measure: A value will be displayed as long as the reading is within 110% of the full scale range noted on the nameplate. The units of measure are factory-set.
- I Am Working (IAW[®]) status: When the unit and process are working properly a circular 4-segment arrow will be revolving around the letters "IAW" in the top center of the display. (For a full description of IAW[®], see Theory of Operation, page 9).
- Offset/Span Adjustment: The word "offset" will appear above the process value, indicating that the offset and/or span calibration has been modified by the user (see Key Programming Features, for a description of Offset and Span). In addition, the user can easily access information such as the set point, deadband and minimum/maximum process readings.
- By pushing the right  button once, the display will scroll as follows:
SP1 XX.XX DB1 XX.XX SP2 XX.XX DB2 X.XX (8X2D model only)
- By pushing the left  button once, the display will scroll the min/max process values seen:
MAX XX.XX MIN XX.XX



The display will revert back to the Process Display mode after scrolling.

ALARM CONDITION

When the process goes beyond the set point, the display will begin to flash, alternating between the process value and "SW1". The display will continue to flash until the process has returned to a value beyond the deadband, at which point the display will revert to normal operation and process value display. If the unit was programmed to have a latching output, a small "Latch" icon will light in the display when the set point is reached, indicating that the output is latched and needs to be manually reset. (See Key Programming Features, for a complete description).

FAULT CONDITIONS

In the case of a fault condition, the display may indicate the following:

If the IAW[®] software detects a fault outside of the micro-controller, and can still operate, it will display an error message.





If the fault is one which affects the micro-controller or the display, the revolving arrow around "IAW" will either freeze or go out.

If it is a failure of the power supply or the wiring, the display will go blank.
(See Fault Codes, page 14 for a complete description of fault diagnostics.)

PROGRAMMING

Tools Required: Software Flowchart, page 20

Step 1: Prior to Programming

Programming of the One Series is done using the two buttons on the faceplate (labeled  and ). By stepping down through the main menu using the left  button, you can access the various features of the One Series. The right  button is then used to move into the feature's sub-menu for setting up or modifying the parameters.

NOTE: See the flowchart on page 20 showing the entire program menu structure.

Important Note: The One Series programming menu is a single direction loop, with submenus embedded in it. Because the main menu is single direction, there is no way to reverse direction and back up in the program. If you need to make a correction to a prior Main Menu step, you will need to continue forward and exit, then re-enter the program and step through to the appropriate feature. If you are in a Submenu, you will need to continue to the beginning of the Submenu and re-enter the Submenu.

The One Series has a number of advanced features you will need to understand before you can effectively use them. These features are discussed next.

NOTE: For safety and security purposes, the One Series will automatically exit the Programming Mode and return to Process Display Mode if it does not detect a key stroke after 2 minutes. If this time-out occurs, all setting parameters will revert back to those saved in memory before reprogramming was initiated. Any changes will be discarded.

Step 2: Entering the Programming Mode





The One Series achieves tamper-resistance using a specific key sequence in order to make program changes. In order to enter the Programming Mode:

- Press the  and  buttons simultaneously
You are now in the Programming Mode.



Use the Flowchart on page 20 as a guide as you step through the various commands in the Programming Mode. In general, the  button is used









for two (2) purposes - to move down through the Programming Mode, and to toggle or increment values in the Submenus. The  button is used to move through the Submenus, and to accept changes.

Step 3: Exiting the Programming Mode

When any of the program commands are displayed, it is possible to exit the Programming Mode by pressing both buttons   simultaneously. For example, you may simply want to make a change to the Switch Mode without accessing any other commands. After changing the Switch Mode, (SP1 is now displayed), press both buttons   and the display will show SAVE CHNG, providing an opportunity to Save or Discard the changes made to the Switch Mode. This ability to exit the programming mode and save or discard changes occurs whenever a program command is displayed.

NOTE: If two minutes elapses without a key being pressed, the program will automatically exit the Programming Mode and discard any changes that were made, reverting back to the previously saved settings and the Process Display mode.





Whenever the Programming Mode is entered and changes have been made to any of the program settings, a choice must be made whether to Save or Discard the changes. At any program command prompt, press both keys   to display SAVE CHNG, then:

- to Save changes, press the right button . NO (the default) will be displayed. Press the left button  to toggle and  display YES. Then press both buttons   to confirm, save the changes and return to the Process Display mode.
- to Discard changes, press the right button . NO will be displayed. Press both buttons   to confirm, discard the changes and return to the Process Display mode.

KEY PROGRAMMING FEATURES

SET UNITS:

The One Series allows the units of measure to be set in the field. The default units are pounds per square inch (PSI) for pressure models and degrees Fahrenheit (°F) for temperature models.

- To change the units of measure press  . The display will read "Set Units."
- Press  and the display will read the default units psi or °F.
- Press  to sequence through the available choices.
- After selecting the desired units, press . The display will return to "Set Units."
- Save the changes and exit the menu. See the Programming Flowchart on page 20 for more details.

NOTE: MAX/MIN memory is reset whenever the units of measure have been changed from the default. Set Point, Deadband, Offset, Span, Plug Port, 4MA and 20 MA values are calculated according to the selected units of measure.

SWITCH MODE:

The One Series allows the switch output to be set up for either 3-state (I Am Working) or 2-state operation. For an overview of the I Am Working (IAW®) function, see page 10.

2-state switch modes: (DEFAULT)

2-state operation is very similar to that of a SPST snap-action switch. The output either opens or closes when a threshold is passed. The One Series has four possible 2-state choices:

- Open on Rise ("OPEN RISE") *
- Open on Fall ("OPEN FALL") *
- Close on Rise ("CLOS RISE") *
- Close on Fall ("CLOS FALL") *

3-state switch modes: (Models 2X2D, 2X3A, 2XLP and 4X3A only)

The 3-state modes take full advantage of the diagnostic capability of the One Series by utilizing the switch to send a remote signal. There are two possible mode choices:

- Pulse on Rise ("PULS RISE")
- Pulse on Fall ("PULS FALL")

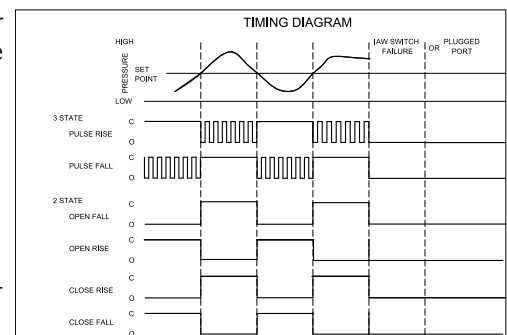

In 3-state operation, the output will be closed (ON-state) for normal, inside threshold operation. If the set point is exceeded, the output will pulse between closed and open. It will change to continuously open to indicate a failure (power out, open wire condition or IAW® diagnostic fault condition). This feature provides the user with important diagnostic information. These modes should be chosen whenever the host is capable of being programmed to detect a pulse waveform. Two pulse widths are available. (See page 20 item 5 for the Pulse Rates.) (See page 16 for Ladder Logic example.)

* **NOTE:** The 2-state control modes have a normally open switch as a valid condition. The self-diagnostic settings (IAW® and Plugged Port) indicate faults remotely using the same open switch signal. As a result, faults will only be indicated locally on the LCD. Remote diagnostics are not possible when these control modes are selected. Opening the contacts on a trip or fault condition should be chosen whenever possible, as this is inherently the better "fail safe" choice (i.e., alarm, power loss or IAW® diagnostic condition). The 2-state modes should also be chosen whenever switching a relay (since relay life would be diminished when over-cycled by the 3-state pulse) or when the host cannot interpret either of the pulse rates of the 3-state pulse waveform. See page 20 item 5 for pulse rate information.

IMPORTANT NOTE: 3-state switch (pulsed) modes must not be used when the switch output is connected directly to a load that could be damaged by being switched at the pulse frequency. For these types of loads, use a 2-state mode.

SET POINT:

The set point is the value at which the One Series changes the state of the output. It is fully adjustable throughout the operating range of the unit (noted on the nameplate). Model 8X2D has two independent set points, one for each switch output.

DEADBAND:

Deadband is the amount above or below the set point at which the One Series changes the output state back to normal operation. In rising modes of operation the deadband must be less than the set point. In falling modes of operation the deadband must be less than the operating range of the unit minus the set point. In the One Series menu, the deadband is represented as a value which is added or subtracted from set point, depending on control mode (e.g., if the Control Mode is "Open on Rise" and the set point is set at 100 psi with a deadband of 10, the output will open as the pressure rises through 100 psi and close as the pressure falls through 90 psi. If the Control Mode is changed to "Open on Fall", the output would open as the pressure falls through 100 psi and close as the pressure rises through 110 psi). The deadband should be set wide enough so that frequent cycling or chatter does not occur, but narrow enough to satisfy conditions for normal process operation. Model 8X2D has two independent deadband settings, one for each switch output.

ADVANCED FEATURES

NOTE: No initial programming of these features is required. The default for these advanced commands is zero or off.

MINIMUM & MAXIMUM READINGS:

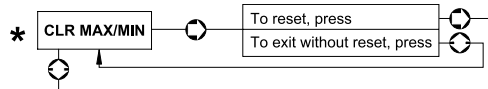

The One Series continuously captures the readings from the sensor and stores the minimum and maximum values since the last time they were reset. These can be viewed at any time by pushing the left button. The display will scroll the information and then return to the Process Display mode. To reset these values, enter the Programming Mode (see page 10), use the left button to get to the CLR MAX/MIN command and press the right button two times. After exiting the Programming Mode and saving the changes (see page 11), the values will be reset to the current reading and begin cumulative recording again.

OFFSET:

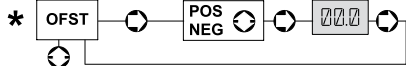

The One Series is factory calibrated to 0.5% of sensor range at room temperature. In some applications it may be necessary to re-calibrate the unit in the field. Offset allows the user to enter a positive ("POS") or negative ("NEG") offset to the display readings. An offset of up to +/- 10% of the range is allowed.

NOTE: Any numerical value entered other than 0.00 will cause the display to indicate "Offset" just above the process reading in the process display.



WARNING: USE OF THIS OPTION MAY CREATE A CONDITION WHERE THE DISPLAY MAY INDICATE "0.00" WHEN SIGNIFICANT PRESSURE OR TEMPERATURE (10% OF RANGE) EXISTS IN THE SYSTEM. INDEPENDENT VERIFICATION OF THE PROCESS VARIABLE SHOULD BE DONE PRIOR TO MAINTENANCE ON THE SYSTEM IF "OFFSET" APPEARS ON THE PROCESS DISPLAY.

SPAN:

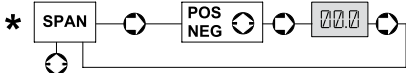

SPAN provides an adjustment to shift the slope of the sensor's response curve. To adjust SPAN, calculate and enter a new SPAN value using the key sequence above. To calculate the SPAN value, apply a reference source below full scale to the One Series sensor. Record the value that shows on the One Series display and the reference source value. Divide the reference source value by the display value and then multiply the result by the sensor's upper range value.

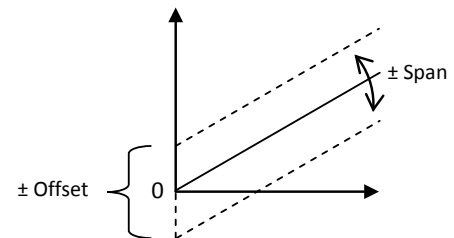

$$\text{SPAN} = \text{reference source} / \text{display value} \times \text{upper range limit}$$

Pressure example: For a sensor range of 0 – 100 psi, choose a reference source (90) below the upper range limit (100) to prevent an over range condition. Divide the reference source value from the resulting display value (88). Multiply the result by the upper range limit.

$$\text{SPAN} = 90 / 88 \times 100 = 102 \text{ (rounded)}$$

Temperature example: For a sensor range of -40 to 450°F, choose a reference source (400) below the upper range limit (450) to prevent an over range condition. Divide the reference source value from the resulting display value (404). Multiply the result by the upper range limit.



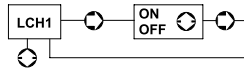

$$\text{SPAN} = 400 / 404 \times 450 = 446 \text{ (rounded)}$$

LATCH MODE: (N/A on Model 8X2D)



The switch output can be configured to latch when the set point is reached.

- Latching Mode: In the Programming Mode, set "LCH1" to "ON". The output changes to the switched state when the set-point is crossed, and will remain in the switched state until it is manually reset by the user.

- To clear a Latched Output: Display will be reading "MAN RSET". To clear and exit, press both buttons   twice.
- To return to the Process Display, without clearing, press the right button .
- To continue programming without clearing, press the left button .

PLUGGED PORT:

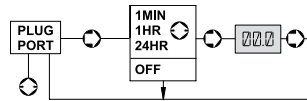

The One Series has the ability to detect process conditions which may indicate that the process port has become blocked, plugged or put into a "bypass" condition. It does this by dynamically monitoring pressure changes over time. If the process does not change by a certain amount during the time period selected (both set by the user), the display will indicate "PLUG" and the output will go to the "open" state.

There are four possible settings for the detection time:

- OFF
- 1 Min.
- 1 Hr.
- 24 Hrs.

Setting the detection time to "OFF" disables the plugged port function. This should be done where danger of plugging is not a concern, or where the system pressures may not change over time (e.g., a storage tank). If the feature is enabled the user must then enter the plugged port range. This number represents the expected variation in the process variable. The number is limited to +/- 10% of the full scale range of the sensor. The diagram below illustrates the feature's operation.

- T₀ Process variable ramp up
- T₁ Process variable stabilizes, new thresholds calculated
- T₂ Threshold exceeded, new thresholds calculated, timer reset
- T₃ Low threshold exceeded, new thresholds calculated, timer reset
- T₄ Plugged Port timer expires, Plugged port condition reported
- T₅ Plugged Port condition cleared, new thresholds calculated, timer reset
- T₆ Low threshold exceeded, new thresholds calculated, timer reset

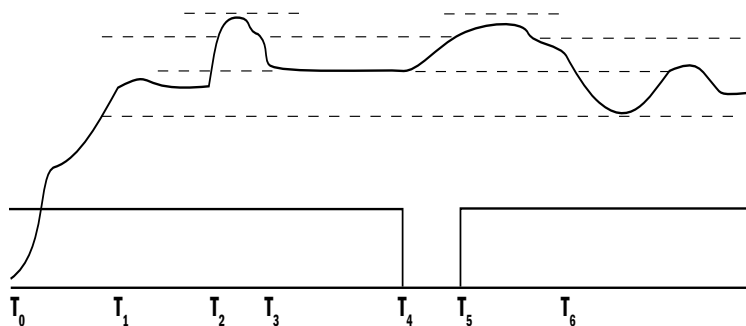

During a plugged port fault (the interval from T₄ to T₅) the display will read "PLUG" and the switch will be set in the "OPEN" state. The fault will be cleared if the pressure varies outside of the detection range or if the feature is disabled by the user.

DELAY:

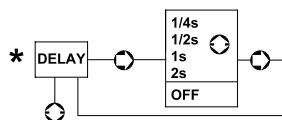

In some applications, it is desirable to "dampen" the switch response and prevent intermittent false trips due to pressure spikes or other transient/isolated events. The Delay feature provides a software digital filter with a programmable time constant for suppressing certain transient short-duration events. The filter settings are:

- OFF
- ¼ second
- ½ second
- 1 second
- 2 seconds

NOTE: The One Series typically responds to a process change in under 60 mSec. Using the Delay feature can lengthen the overall response time of the switch for certain types of pressure changes.

- A shorter delay setting provides a faster response but is less stable.
- A longer delay setting provides a slower response and is more stable.

SCALE: (2XLP and 8X2D models only)

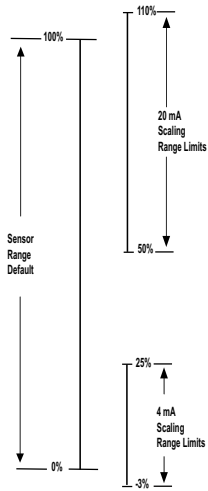
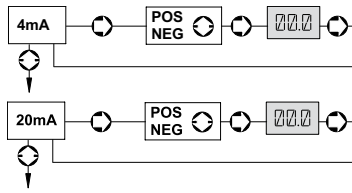

The 4-20 mA output on model 2XLP and 8X2D is field scalable. The default setting is 100% of sensor range, where 4 mA represents 0 and 20 mA is full range scale. If desired, both the 4 mA and 20 mA levels may be set independently to adjust the portion of the sensor's range represented by the 4-20 mA output.

Enter the Programming Mode (see page 11) and push the left button repeatedly until you reach the 4 mA command. Press the right button and select POS or NEG. Press the right button and enter the new sensor value that will be represented by 4 mA. This value must be between -3% and 25% of the sensor's range. Press the right button after entering the value. Press the left button to reach the 20 mA command. Press the right button and select POS or NEG. Press the right button and enter the new sensor value that will be represented by 20 mA. This value must be between 50% and 110% of the sensor's range. Press the right button after entering the value. Exit the Programming Mode (see page 11).

Note: Analog values between 4 and 20 mA are recalculated for the new lower and upper sensor values entered using the 4 mA and 20 mA commands, providing a scaled proportional output that covers a modified portion of the sensor's range. Scaling the 4-20 mA output over a smaller portion of the sensor's range does not increase the accuracy of the proportional output. 2:1 turndown is possible with these commands.

FAULT CODES

Patented IAW® diagnostics are capable of detecting many possible fault conditions. Some fault conditions will clear automatically when the parameter returns to normal; others require the unit to be powered down and restarted; and some are catastrophic and require repair or replacement. A list of fault conditions is shown below:

DISPLAY WILL SCROLL:	FAULT:	RESULT:	SWITCH OUTPUT:	4-20 mA OUTPUT:
PLUG	Plugged Port Detected	Return to normal when condition clears	Open	24 mA
UNDER RANGE	Sensor Under Range	Return to normal when condition clears	As Programmed	3.5 mA (min)
OVER RANGE	Sensor Over Range	Return to normal when condition clears	As Programmed	22.0 mA (max)
EXTREME OVER RANGE	Sensor Over Range	Return to normal when condition clears	As Programmed	24 mA
SENSOR FAULT	Open Sensor	Recovery on power reset likely if fault does not re-occur	Open	24 mA
SENSOR FAULT	Shorted Sensor	Recovery on power reset likely if fault does not re-occur	Open	24 mA
REF. FAULT	Reference Voltage	Return to normal when condition clears	Open	24 mA
P/S OUT OF RANGE	Power Supply	Recovery on power reset likely if fault does not re-occur	Open	24 mA
SWITCH FAULT	Switch Voltage	Recovery on power reset likely if fault does not re-occur	Open	24 mA
KEYPAD ERROR	Keypad Shorted	Recovery on power reset likely if fault does not re-occur	Open	24 mA
WDOG	Watch Dog Timer	Recovery on power reset likely if fault does not re-occur	Open	24 mA
EEPROM CS ERROR	EEPROM Checksum error	Recovery on power reset likely if fault does not re-occur	Open	24 mA

NOTE: The 4-20 mA output may reach 22 mA in an over range condition. 24 mA output is intended to indicate a fault.

DISPLAY MODULE CALIBRATION



These serial numbers must match for proper operation.

NOTE: Do not attempt to replace the One Series display module or pressure sensor. Swapping these will cause a mis-match between the stored calibration data and the pressure sensor. For proper operation, the display module serial number must always match the serial number inside the enclosure.

ACCEPTABLE SUPPLY VOLTAGES AND LOADS FOR 2X MODELS

The charts below provide a range of acceptable power supply voltages (in Volts) and series loads (in Ohms). This is useful when the One Series 2-Wire is connected to non-standard PLC and DCS inputs or is connected in series with a relay or solenoid coil. For the 2X2D models a maximum of 30 VDC supply voltage and a load of 40 mA must not be exceeded. For 4X2D models a maximum of 50 VDC supply voltage and a load of 40 mA must not be exceeded. For the 2X3A models a maximum of 130 VAC/VDC supply voltage and a load of 100 mA must not be exceeded. Permanent damage to the One Series 2-Wire electronics may result if the supply voltages are exceeded.

NOTE: If you need assistance with determining the compatibility of the One Series with your PLC, DCS, or relay, we can help. Please have the manufacturer's model number ready when you call us. In rare cases, when the series resistor value is too large and falls out of the Acceptable Range, placing another resistor across the input will allow it to work. Please call (617) 926-1000 (Technical Sales) for assistance.

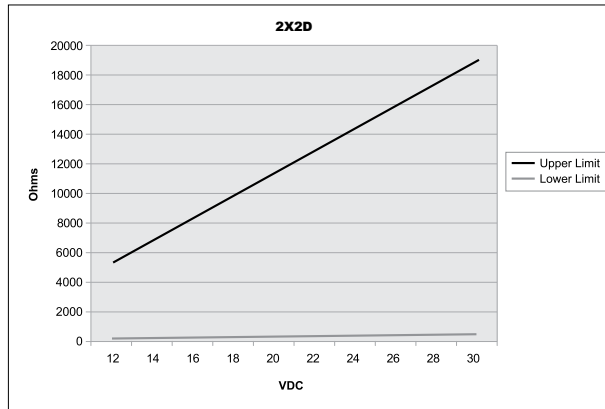

Please note that a maximum of 30 VDC supply voltage and a load of 40 mA must not be exceeded or permanent damage to the One Series 2-Wire electronics may result.

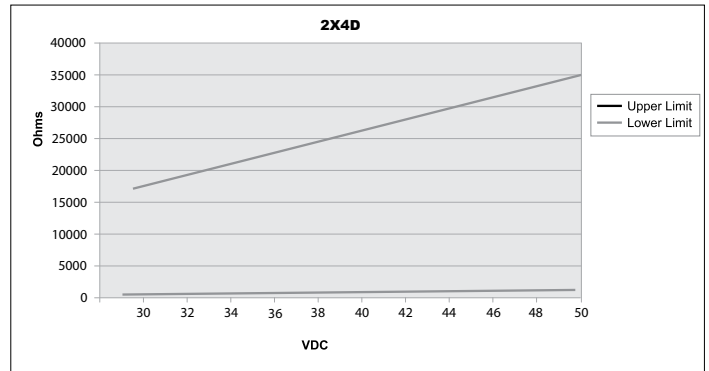

Please note that a maximum of 50 VDC supply voltage and a load current of 40 mA must not be exceeded or permanent damage to the One Series 2-Wire electronics may result.

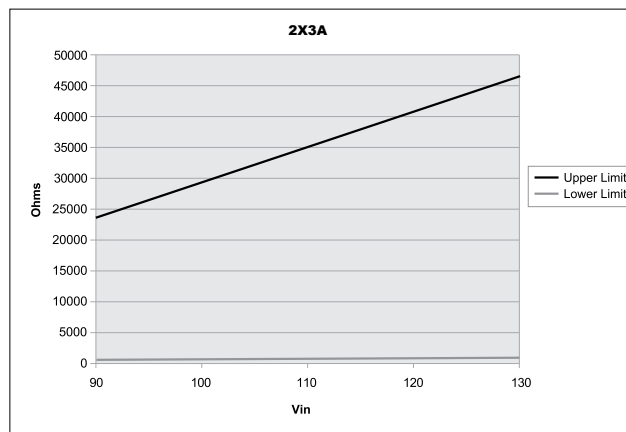

Please note that a maximum of 130 VAC/VDC supply voltage and a load of 100 mA must not be exceeded or permanent damage to the One Series 2-Wire electronics may result.

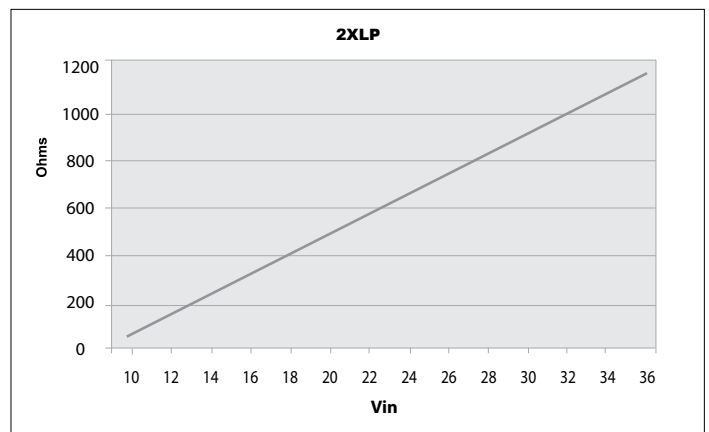

Please note that Model 2XLP obtains loop-power from a 4-20 mA input. The chart at left shows the maximum load resistance allowed at various voltages. Typically, this resistance is provided internally by the PLC or DCS. No external resistor is required.

LADDER LOGIC EXAMPLE

(used for detecting the pulsed output)

Ladder logic for One Series model 2X2D

Pulse-on-rise output (25 mSec)

Ladder logic for One Series 2-Wire
Pulse-on-rise output (25mSec)

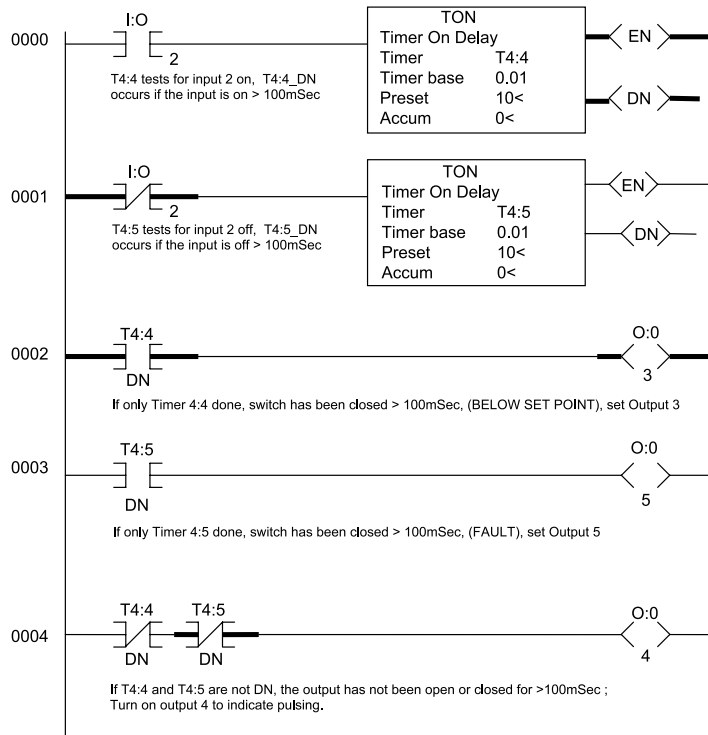

ZONE HAZARDOUS LOCATIONS FLAMEPROOF GAP AND JOINT DETAILS

Enclosure to cover threaded joint: 4"-16 UN-2, 7 threads engaged min.

Glass to cover cemented joint: 0.753" (19.1mm) rabbet/spigot min. length

Breather element threaded joint: 1/4"-20 UNC-2, 10 threads engaged min.

Electrical conduit threaded joint: 3/4"-14 NPT, 5 threads engaged min.

Enclosure to sensor threaded joint:

- Pressure models: 1"-20 UNEF-2, 10 threads engaged min.
- Temperature models: 1/2"-14 NPT, 5 threads engaged min.

Remote and local spring loaded temperature sensor gap joints: 0.0045" (0.114mm) max. annular gap by 1.25" (31.8mm) min. length.

TROUBLESHOOTING

The switches contained in the One Series are electronic. The on/off switch signal is produced by a transistor or a solid-state relay, depending on the One Series model. Electronic switches cannot be properly tested with an ohmmeter. Instead, measure the voltage drop across the switch connected to the intended load to determine if it is open or closed. A properly functioning One Series electronic switch will exhibit the following voltage levels:

Model	Voltage Open	Voltage Closed
2X2D	12-30 VDC	4.7 VDC
2X3A	90-130 VAC/VDC	13.0 VAC/VDC
2X4D	30-50 VDC	5.0 VDC
2XLP41	0-140 VAC/VDC	0 VAC/VDC

Model	Voltage Open	Voltage Closed
2XLP43	0-280 VAC/VDC	0 VAC/VDC
4X3A	24-280 VAC	0 VAC
8X2D42	75-250 VAC	0 VAC
8X2D45	0-140 VAC/VDC	0 VAC/VDC

ONE SERIES SWITCH MODES

Switch Mode Applications Sheet - Below are the 6 switch modes for the One Series electronic pressure and temperature switches. All models ship as normally closed switches that will open on rising media. One Series 8X2D models do not include the pulse modes. Regardless of how a One Series is programmed, the switch is designed to open if the IAW® self-diagnostics sense a failure. The One Series is a fail-safe-open device. Please refer to the [One Series Installation & Maintenance manual](#) for additional information.

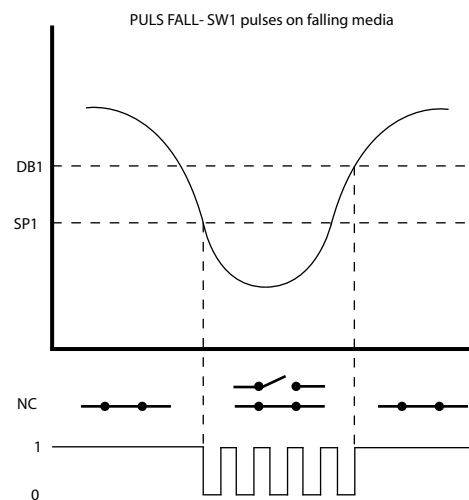
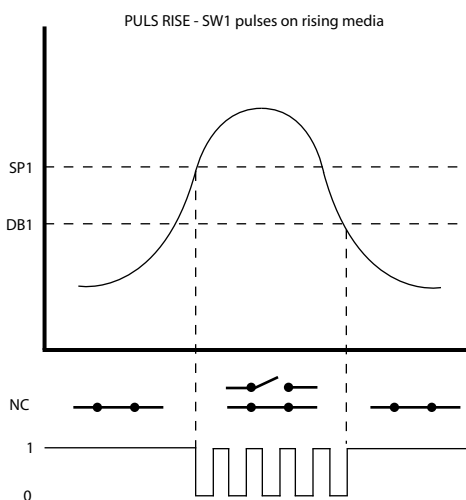
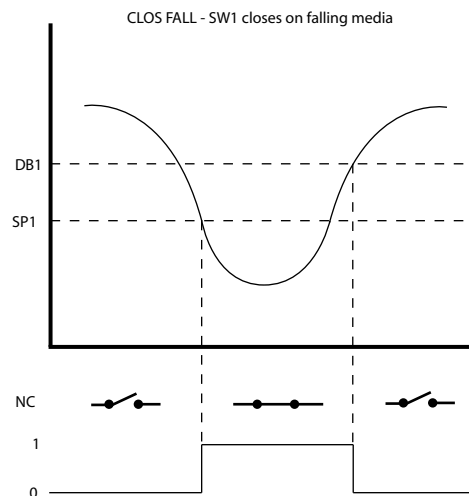
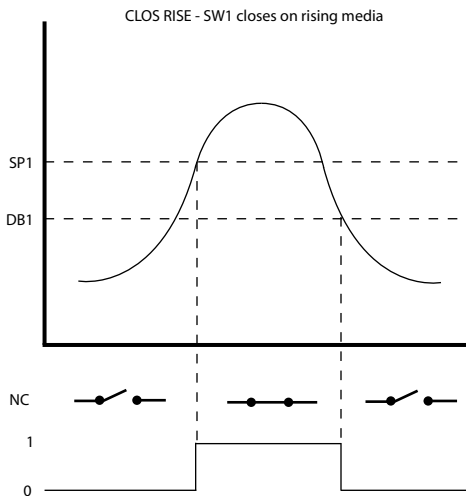
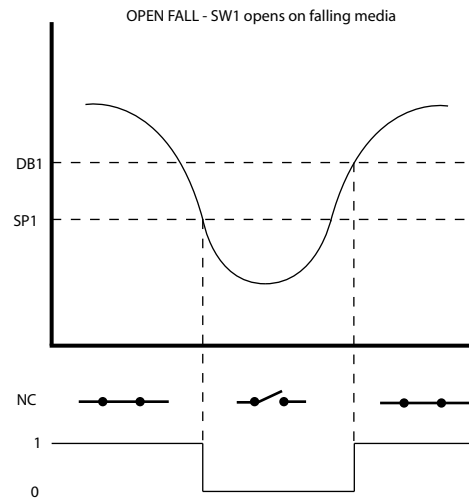
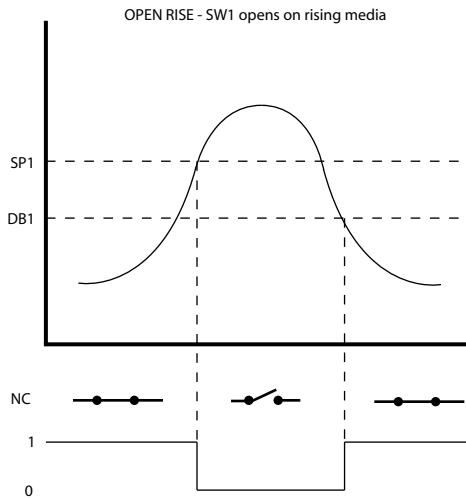

ONE SERIES SWITCH MODES

Application Note: One Series model 8X2D contains two SPST solid-state relay (SSR) switches. Each switch has a fully adjustable and independent set point, deadband (hysteresis) and switch mode. The switches can be combined to create a Form C (SPDT) contact. Please see the diagram below.

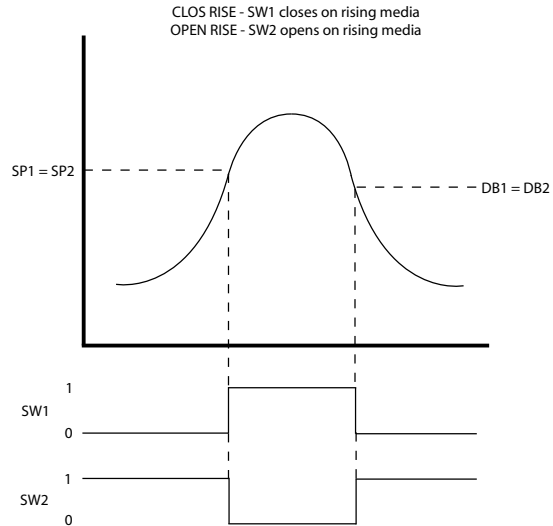
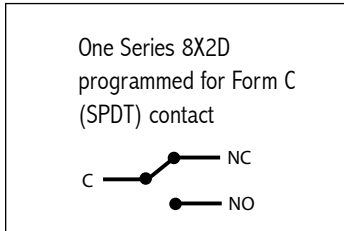

The One Series 8X2D contains two potential-free SSR switches that can be wired in series or parallel for switch logic applications. This makes it possible to wire the switches in series and program them for Window Mode operation where a specific media range can be detected. Please see the diagram below.

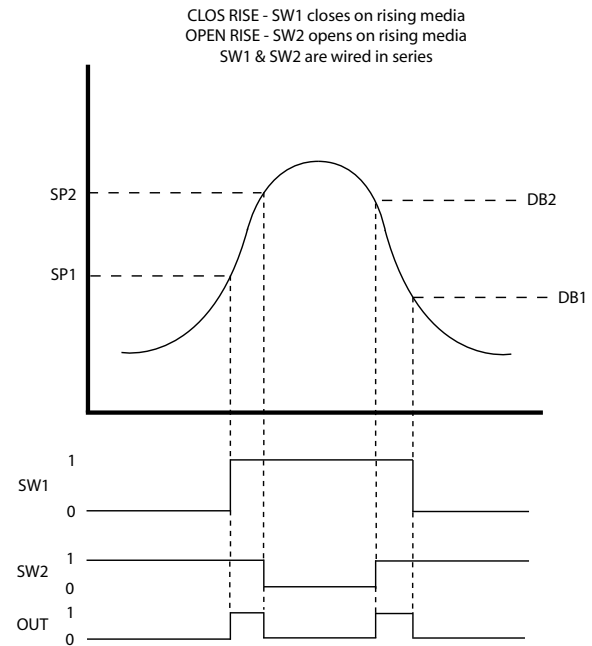
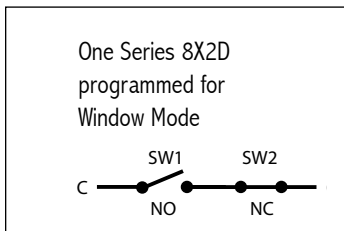

ONE SERIES ERROR MESSAGES

If an error message appears on the One Series display, an error code can be obtained by pressing both keypad buttons simultaneously. Please provide this code if calling UE Technical Sales for assistance.

Error Message	Error Code	Probable Causes	Possible Corrective Actions	
			Try This First	Other Options
EEPROM CS ERR	0002	Checksum error on serial EEPROM (used to store config. Cal. Data).	Cycle power. In most cases, it should clear the error and operate normally.	If error does not clear, unit has to be returned for factory repair
FACT		Factory programming mode. Usually caused either by shorting the pins internally or touching the enclosure while energized.	Inspect pins on the rear of the display and make sure they are not touching one another or the case. Cycle power and error should clear.	If error does not clear, unit has to be returned for factory repair
KEY STUCK	0008	Keypad button stuck.	Cycle power. In most cases, it should clear the error and operate normally.	If error does not clear, unit has to be returned for factory repair.
OVER RNG	0020	Process exceeding 110% of range.	Automatic reset when process variable returns to normal.	If error continues, check for sensor damage due to over/under range exposure. Return for repair.
OVER RNG	0200	Process exceeding 150% of range.	Automatic reset when process variable returns to normal.	If error continues, check for sensor damage due to over/under range exposure. Return for repair.
OVER RNG	0220	Extreme over range for all sensors except the 0 to 5 psi range.	Automatic reset when process variable returns to normal.	If error continues, check for sensor damage due to over/under range exposure. Return for repair.
UNDER/ OVER RNG	0330	Extreme under and over range for the 0 to 5 psi range.	Automatic reset when process variable returns to normal.	If error continues, check for sensor damage due to over/under range exposure. Return for repair.
P/S OUT OF RNG	0040	Voltage into unit's regulator is less than 3.5 Volts or more than 35 Volts. Also if series load resistance is too high (2-Wire devices only).	Check Voltage input to unit and the load resistance (check the installation sheet for upper and lower limit values of the series load). Error will clear if conditions return to normal.	Cycle power. If error returns, return for factory repair.
PLUG	8000	Plugged port condition exists.	Is pressure dynamic? Is sensor plugged? Is plug port setup OK?	Turn feature off. If error continues, return for repair.
REF. FAULT	1000	The onboard reference voltage is out of range.	Ref. Fault can be caused by the presence of electrical noise. Eliminate electrical noise sources.	If problem persists, return product to factory for repair.
SENSOR FAULT	0400	Sensor has an open circuit.	Check for broken wire or unplugged sensor connection. Cycle power.	If problem persists, return product to factory for repair.
SENSOR FAULT	0800	Sensor has a short circuit.	Check for shorted connection on the sensor. Cycle power.	If problem persists, return product to factory for repair.
SWITCH FAULT	0080	Switch voltage is too high in closed state, or too low in open state. Only happens on 2X2D and 2X3A models. <i>Note: on 2X3A models, this may have been caused by connecting unit to power with no load in series or by touching pins to case.</i>	Cycle Power. In most cases, it should clear the error and operate normally.	If fault persists, return product to factory for repair.
WDOG	0004	Watchdog timed out. Could be caused by transients on power supply during power up or unit connected to a load resistance that is too high.	Review load resistance with customer. Cycle power. In most cases, it should clear the error and operate normally.	If error continues, try a different power supply or unit has to be returned to factory for repair.
All errors that start with two alphanumeric digits	EX??	Causes are various.	Cycle power. In most cases, it should clear the error and operate normally.	If error does not clear, unit has to be returned for factory repair.

PROGRAMMING FLOWCHART

PROCESS DISPLAY

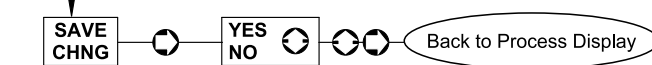
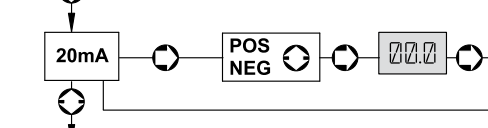
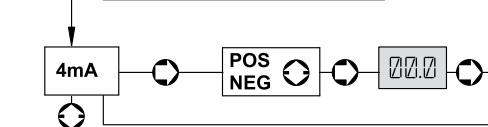
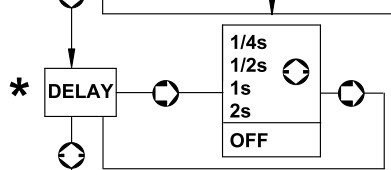
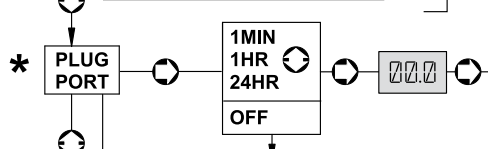
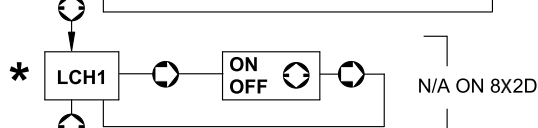
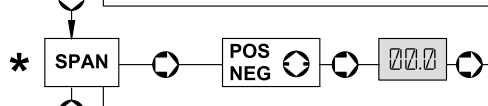
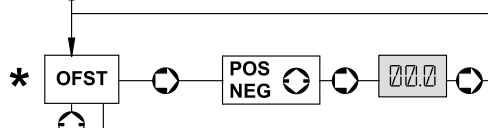
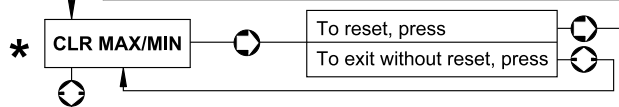
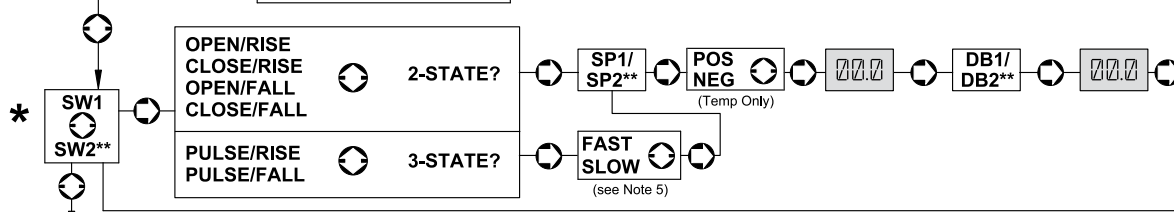
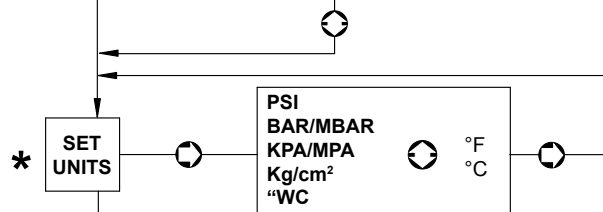
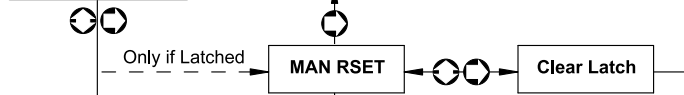
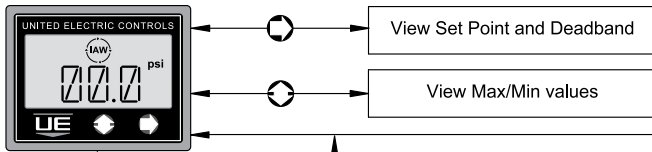

BASIC COMMANDS

ADVANCED COMMANDS

Programming Instructions and Notes:

1. Read the appropriate sections of the I&M for more information on the commands.
2. In numerical fields , use the button to increment the blinking digit, then the button to move on.
3. If the numerical value entered results in a reading outside the operating range of the switch, the display will read "ERR". Press button to re-enter a new value inside the range boundaries.
4. *Programming shortcut: Pressing both buttons simultaneously will bypass the rest of the program and take you to the "SAVE CHNG" command.
5. Pulse rates vary by model.

	2X2D	2X3A	8X2D
Fast=	25 mS	200 mS	N/A
Slow=	100 mS	500 mS	N/A

MODEL 2XLP AND 8X2D ONLY

* PRESS BOTH BUTTONS TO SKIP TO "SAVE CHNG" COMMAND

**8X2D ONLY

DIMENSIONAL DRAWINGS

All One Series Models

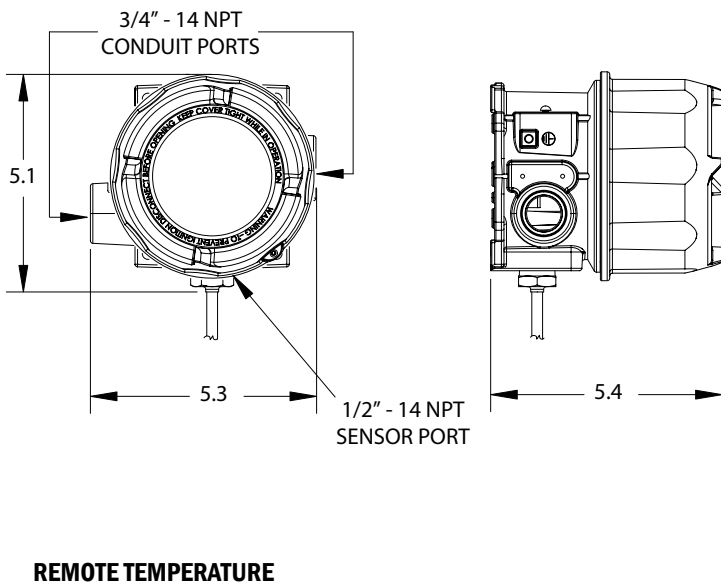
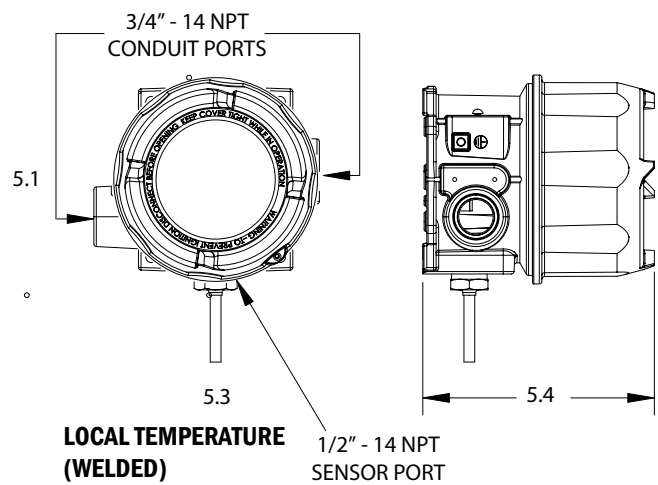
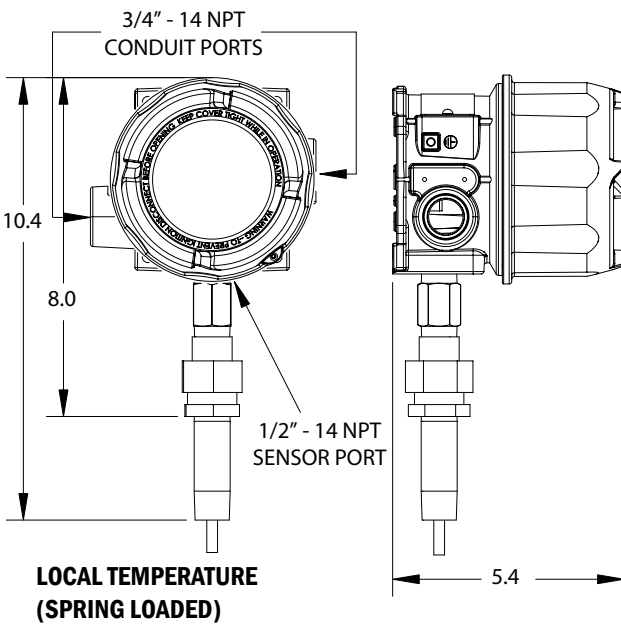
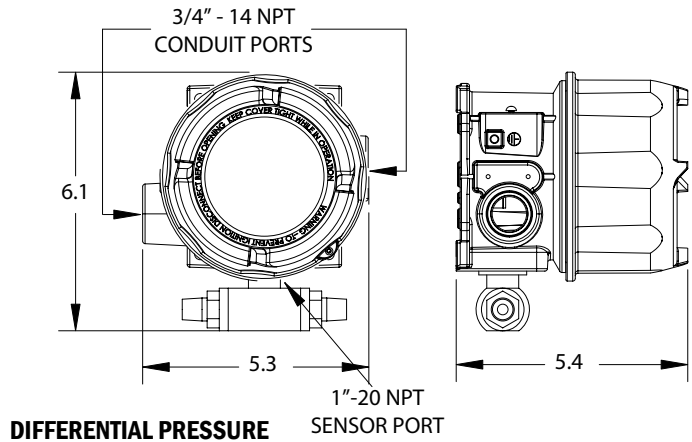
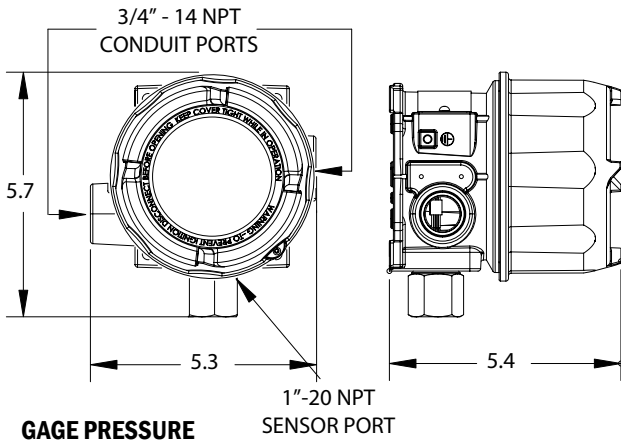

CLEARANCE HOLE FOR 1/4" BOLT
4 PLCS

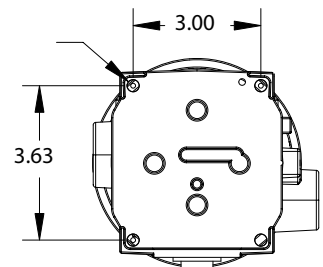

SURFACE MOUNTING KIT 6361-704

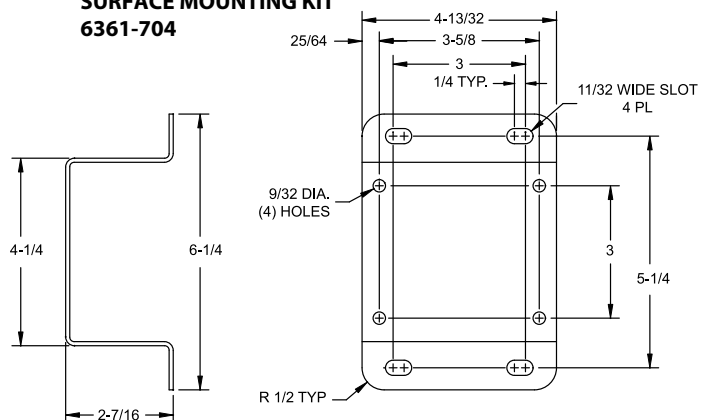

SENSOR OPTIONS

Pressure Sensors

Gauge Pressure

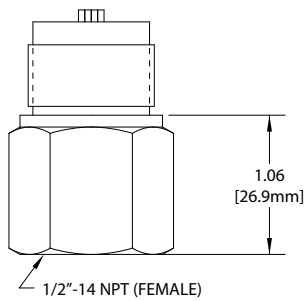

Differential Pressure

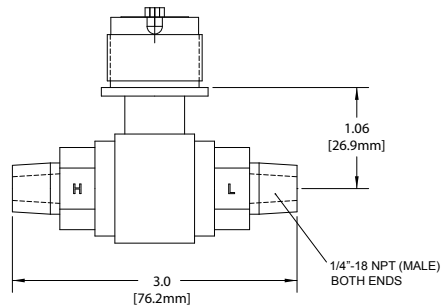

Temperature Sensors

Fixed Local (TL1 - TL3)

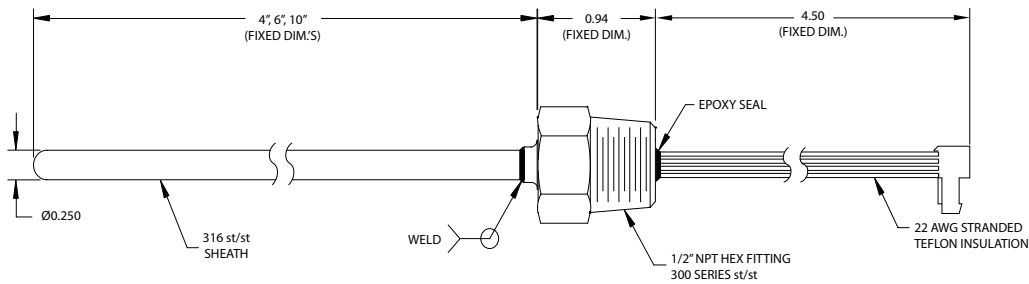

Spring Loaded Local (TTC)

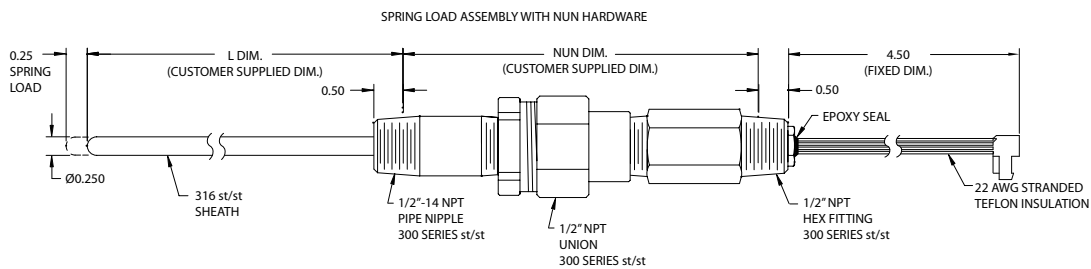

Remote (TR1, TRC, TH1, THC, TC1, TCC)

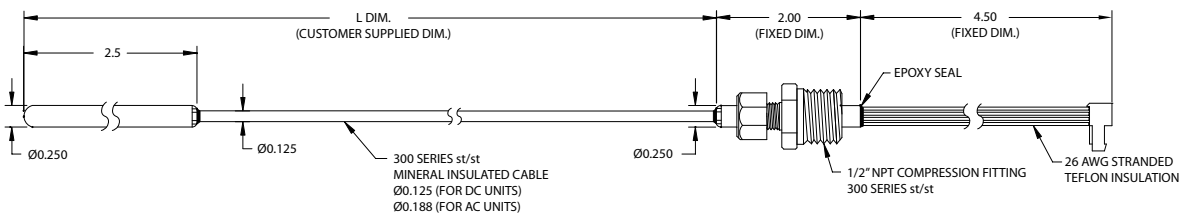

NOTES:

RECOMMENDED PRACTICES AND WARNINGS

United Electric Controls Company recommends careful consideration of the following factors when specifying and installing UE pressure and temperature units. Before installing a unit, the Installation and Maintenance instructions provided with unit must be read and understood.

- To avoid damaging unit, proof pressure and maximum temperature limits stated in literature and on nameplates must never be exceeded, even by surges in the system. Operation of the unit up to maximum pressure or temperature is acceptable on a limited basis (e.g., start-up, testing) but continuous operation must be restricted to the designated adjustable range. Excessive cycling at maximum pressure or temperature limits could reduce sensor life.
- A back-up unit is necessary for applications where damage to a primary unit could endanger life, limb or property. A high or low limit switch is necessary for applications where a dangerous runaway condition could result.
- The adjustable range must be selected so that incorrect, inadvertent or malicious setting at any range point cannot result in an unsafe system condition.
- Install unit where shock, vibration and ambient temperature fluctuations will not damage unit or affect operation. When applicable, orient unit so that moisture does not enter the enclosure via the electrical connection. When appropriate, this entry point should be sealed to prevent moisture entry.
- Unit must not be altered or modified after shipment. Consult UE if modification is necessary.
- Monitor operation to observe warning signs of possible damage to unit, such as drift in set point or faulty display. Check unit immediately.
- Preventative maintenance and periodic testing is necessary for critical applications where damage could endanger property or personnel.
- Electrical ratings stated in literature and on nameplate must not be exceeded. Overload on a switch can cause damage, even on the first cycle. Wire unit according to local and national electrical codes, using wire size recommended in installation sheet.
- Do not mount unit in ambient temp. exceeding published limits.

LIMITED WARRANTY

Seller warrants that the product hereby purchased is, upon delivery, free from defects in material and workmanship and that any such product which is found to be defective in such workmanship or material will be repaired or replaced by Seller (Ex-works, Factory, Watertown, Massachusetts. INCOTERMS); provided, however, that this warranty applies only to equipment found to be so defective within a period of 24 months from the date of manufacture by the Seller (36 months for the Spectra 12 and One Series products; 18 months for Temperature Sensors). Seller shall not be obligated under this warranty for alleged defects which examination discloses are due to tampering, misuse, neglect, improper storage, and in any case where products are disassembled by anyone other than authorized Seller's representatives. EXCEPT FOR THE LIMITED WARRANTY OF REPAIR AND REPLACEMENT STATED ABOVE, SELLER DISCLAIMS ALL WARRANTIES WHATSOEVER WITH RESPECT TO THE PRODUCT, INCLUDING ALL IMPLIED WARRANTIES OF MERCHANTABILITY OR FITNESS FOR ANY PARTICULAR PURPOSE.

LIMITATION OF SELLER'S LIABILITY

Seller's liability to Buyer for any loss or claim, including liability incurred in connection with (i) breach of any warranty whatsoever, expressed or implied, (ii) a breach of contract, (iii) a negligent act or acts (or negligent failure to act) committed by Seller, or (iv) an act for which strict liability will be inputted to seller, is limited to the "limited warranty" of repair and/or replacement as so stated in our warranty of product. In no event shall the Seller be liable for any special, indirect, consequential or other damages of a like general nature, including, without limitation, loss of profits or production, or loss or expenses of any nature incurred by the buyer or any third party.

UE specifications subject to change without notice.



UNITED ELECTRIC
CONTROLS

180 Dexter Ave. P.O. Box 9143, Watertown, MA 02472-9143 USA

617 926-1000 Fax 617 926-2568

www.ueonline.com

CP08113000