

Capacitance Switches





Pointek CLS200/CLS300 (Standard)



Quick Start Manual · 03/2013









SIEMENS



CLS200 Standard



SIEMENS		Standard
POINTEK CLS200 7MLxxxx-xxxx-xxxx [Box a][Box 7] Serial No.: GYZ / S1034567 Input: 12 – 250 V $\overline{\sim}$, Max. 2 W, 0 - 60 Hz		
 APPROVED	 N117	  
Amb. Temp.: –40 °C to 85 °C Encl.: [BOX 1] Cable Entry: [BOX 2]		



SIEMENS		Standard
POINTEK CLS200 7MLxxxx-xxxx-xxxx [Box a][Box 7] Serial No.: GYZ / S1034567 Input: 12 – 250 V $\overline{\sim}$, Max. 2 W, 0 - 60 Hz		
 APPROVED		
Amb. Temp.: –40 °C to 85 °C Encl.: [BOX 1] Cable Entry: [BOX 2]		
Class I, Div 1, Gr. A, B, C, D Class II, Div 1, Gr. E, F, G Class III T4 Seal Conduit < 18 inches Use Suitably Rated Cable If Ambient Temp. > 70 °C Do Not Open When An Explosive Atmosphere Is Present		

SIEMENS		Standard
POINTEK CLS200 7MLxxxx-xxxx-xxxx [Box a][Box 7] Serial No.: GYZ / S1034567 Input: 12 – 250 V $\overline{\sim}$, Max. 2 W, 0 - 60 Hz		
 APPROVED		
Amb. Temp.: –40 °C to 85 °C Encl.: [BOX 1] Cable Entry: [BOX 2]		
Siemens Milltronics Process Instruments Inc.		

SIEMENS		Standard
POINTEK CLS200 7MLxxxx-xxxx-xxxx [Box a][Box 7] Serial No.: GYZ / S1034567 Input: 12 – 250 V $\overline{\sim}$, Max. 2 W, 0 - 60 Hz		
 APPROVED		
Amb. Temp.: –40 °C to 85 °C Encl.: [BOX 1] Cable Entry: [BOX 2]		
Class II, Div 1, Gr. E, F, G Class III T4 Do Not Open When An Explosive Dust Atmosphere Is Present		

SIEMENS		Standard
POINTEK CLS200 7MLxxxx-xxxx-xxxx [Box a][Box 7] Serial No.: GYZ / S1034567 Input: 12 – 250 V $\overline{\sim}$, Max. 2 W, 0 - 60 Hz		
 APPROVED		
Encl.: [BOX 1] Cable Entry: [BOX 2]		
Use Suitably Rated Cable If Ambient Temp. > 70 °C Refer To Applicable Certificate For Temp. Rating Do Not Open When An Explosive Atmosphere Is Present		





SIEMENS		Standard
POINTEK CLS200 7MLxxxx-xxxx-xxxx [Box a][Box 7] Serial No.: GYZ / S1034567 Input: 12 – 250 V $\overline{\sim}$, Max. 2 W, 0 - 60 Hz		
 APPROVED		
Encl.: [BOX 1] Cable Entry: [BOX 2]		
Use Suitably Rated Cable If Ambient Temp. > 70 °C Refer To Applicable Certificate For Temp. Rating Do Not Open When An Explosive Atmosphere Is Present		



SIEMENS		Standard
POINTEK CLS200 7MLxxxx-xxxx-xxxx [Box a][Box 7] Serial No.: GYZ / S1034567 Input: 12 – 250 V $\overline{\sim}$, Max. 2 W, 0 - 60 Hz		
 APPROVED		
Encl.: [BOX 1] Cable Entry: [BOX 2]		
Use Suitably Rated Cable If Ambient Temp. > 70 °C Do Not Open When An Explosive Dust Atmosphere Is Present		





SIEMENS		Standard
POINTEK CLS200 7MLxxxx-xxxx-xxxx [Box a][Box 7] Serial No.: GYZ / S1034567 Input: 12 – 250 V $\overline{\sim}$, Max. 2 W, 0 - 60 Hz		
 APPROVED		
Encl.: [BOX 1] Cable Entry: [BOX 2]		
Use Suitably Rated Cable If Ambient Temp. > 70 °C Do Not Open When An Explosive Dust Atmosphere Is Present		



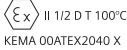

Note: Information in boxes 1 through 7 changes based on customer order.



CLS300 Standard



SIEMENS		Standard
POINTEK CLS300 7MLxxxx-xxxx-xxxx [BOX 6][BOX 7] Serial No.: GYZ / S1034567 Input: 12 – 250 V $\overline{\sim}$, Max. 2 W, 0 - 60 Hz Amb. Temp.: – 40 °C to 85 °C Encl.: [BOX 1] Cable Entry: [BOX 2]		
    		

SIEMENS		Standard
POINTEK CLS300 7MLxxxx-xxxx-xxxx [BOX 6][BOX 7] Serial No.: GYZ / S1034567 Input: 12 – 250 V $\overline{\sim}$, Max. 2 W, 0 - 60 Hz Amb. Temp.: – 40 °C to 85 °C Encl.: [BOX 1] Cable Entry: [BOX 2]		
  		
Siemens Milltronics Process Instruments Inc.		

SIEMENS		Standard
POINTEK CLS300 7MLxxxx-xxxx-xxxx [BOX 6][BOX 7] Serial No.: GYZ / S1034567 Input: 12 – 250 V $\overline{\sim}$, Max. 2 W, 0 - 60 Hz Amb. Temp.: – 40 °C to 85 °C Encl.: [BOX 1] Cable Entry: [BOX 2]		
    		
Use Suitably Rated Cable If Ambient Temp. > 70 °C Do Not Open When An Explosive Dust Atmosphere Is Present		

SIEMENS		Standard
POINTEK CLS300 7MLxxxx-xxxx-xxxx [BOX 6][BOX 7] Serial No.: GYZ / S1034567 Input: 12 – 250 V $\overline{\sim}$, Max. 2 W, 0 - 60 Hz Encl.: [BOX 1] Cable Entry: [BOX 2]		
    		
Use Suitably Rated Cable If Ambient Temp. > 70 °C Refer To Applicable Certificate For Temp. Rating Do Not Open When An Explosive Atmosphere Is Present		

SIEMENS		Standard
POINTEK CLS300 7MLxxxx-xxxx-xxxx [BOX 6][BOX 7] Serial No.: GYZ / S1034567 Input: 12 – 250 V $\overline{\sim}$, Max. 2 W, 0 - 60 Hz Amb. Temp.: – 40 °C to 85 °C Encl.: [BOX 1] Cable Entry: [BOX 2]		
  		
Class II, Div 1, Gr. E, F, G Class III T4 Do Not Open When An Explosive Dust Atmosphere Is Present		

SIEMENS		Standard
POINTEK CLS300 7MLxxxx-xxxx-xxxx [BOX 6][BOX 7] Serial No.: GYZ / S1034567 Input: 12 – 250 V $\overline{\sim}$, Max. 2 W, 0 - 60 Hz Amb. Temp.: – 40 °C to 85 °C Encl.: [BOX 1] Cable Entry: [BOX 2]		
  		
Class I, Div 1, Gr. A, B, C, D Class II, Div 1, Gr. E, F, G Class III T4 Seal Conduit < 18 inches Use Suitably Rated Cable If Ambient Temp. > 70 °C Do Not Open When An Explosive Atmosphere Is Present		

SIEMENS		Standard
POINTEK CLS300 7MLxxxx-xxxx-xxxx [BOX 6][BOX 7] Serial No.: GYZ / S1034567 Input: 12 – 250 V $\overline{\sim}$, Max. 2 W, 0 - 60 Hz Encl.: [BOX 1] Cable Entry: [BOX 2]		
  		
Ex d [ia Ga] IIC T6...T4 Gb Ex tb IIC T85 °C...T100 °C Db DNV 12.0073 X ATENÇÃO - NÃO ABRA ONDE UMA ATMOSFERA EXPLOSIVA POSSA ESTAR PRESENTE ATENÇÃO - UTILIZAR CABOS ADEQUADOS PARA TEMPERATURA AMBIENTE > 70°C Siemens Milltronics Process Instruments, Peterborough		

Note: Information in boxes 1 through 7 changes based on customer order.

Pointek CLS200/300 (Standard) Quick Start Manual

This manual outlines the essential features and functions of the Pointek CLS200/300. We strongly advise you to acquire the detailed version of the manual so you can use your instrument to its fullest potential. The complete manual is available at: www.siemens.com/level. The printed manual is available from your Siemens Milltronics representative.

Questions about the contents of this manual can be directed to:

Siemens Milltronics Process Instruments
1954 Technology Drive, P.O. Box 4225
Peterborough, Ontario, Canada, K9J 7B1
Email: techpubs.smpi@siemens.com

**Copyright Siemens Milltronics
Process Instruments 2013.
All Rights Reserved**

Disclaimer of Liability

We encourage users to purchase authorized bound manuals, or to view electronic versions as designed and authored by Siemens Milltronics Process Instruments. Siemens Milltronics Process Instruments will not be responsible for the contents of partial or whole reproductions of either bound or electronic versions.

While we have verified the contents of this manual for agreement with the instrumentation described, variations remain possible. Thus we cannot guarantee full agreement. The contents of this manual are regularly reviewed and corrections are included in subsequent editions. We welcome all suggestions for improvement.

Technical data subject to change.

MILLTRONICS is a registered trademark of Siemens Milltronics Process Instruments

Safety Guidelines

Warning notices must be observed to ensure personal safety as well as that of others, and to protect the product and the connected equipment. These warning notices are accompanied by a clarification of the level of caution to be observed:



WARNING: relates to a caution symbol on the product, and means that failure to observe the necessary precautions can result in death, serious injury, and/or considerable material damage.



WARNING¹: means that failure to observe the necessary precautions can result in death, serious injury, and/or considerable material damage.

CAUTION: means that failure to observe the necessary precautions can result in considerable material damage.

Note: means important information about the product or that part of the operating manual.

¹ This symbol is used when there is no corresponding caution symbol on the product.

Pointek CLS200/300 (Standard)

Note: Pointek CLS200/300 is to be used only in the manner outlined in this manual, otherwise protection provided by the equipment may be impaired.

This product is intended for use in industrial areas. Operation of this equipment in a residential area may cause interference to several frequency based communications.

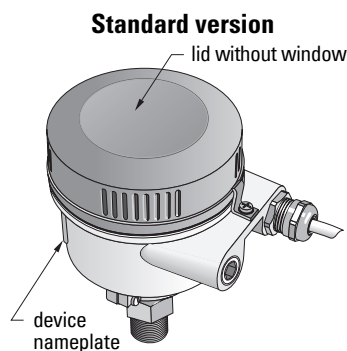

Pointek CLS200/300 is a versatile capacitance switch with a high level of chemical resistance; ideal for level detection of interfaces, solids, liquids, slurries, and foam, and for simple pump control.

Approvals (verify against device nameplate)

- CE, CSA_{C/US}, FM, ATEX, INMETRO
- Vlare II, WHG
- Lloyd's Register of Shipping, categories ENV1, ENV2, and ENV5

Note: The use of approved watertight conduit hubs/glands is required. Type 6 / NEMA 6, IP68 (outdoor applications). For CE requirements cable entries is required.

Process connections

Compact (std.) configuration	R ¾", 1", 1 1/4", 1 ½" BSPT; ¾", 1", 1 1/4", 1 ½" NPT; G ¾", 1", 1 ½" BSPP
Sanitary configuration	1", 1 ½", 2", 2 ½" and 3" tri-clamp
Cable and slide coupling configuration	R ¾", 1", 1 1/4", 1 ½" BSPT; ¾", 1", 1 1/4", 1 ½" NPT (Taper); G ¾", 1", 1 ½" BSPP

Ambient Conditions

- general applications –40 to +85 °C (–40 to +185 °F)
- in potential explosive atmospheres check temperature class shown on device nameplate

Process Conditions

Note: Please see full Operating Instructions for Process Pressure/Temperature De-rating Curves.

- relative dielectric constant (ϵ_r) 1.5 minimum
- CLS200 temperature¹:
 - without thermal isolator –40 to +85 °C (–40 to +185 °F)
 - with thermal isolator –40 to +125 °C (–40 to +257 °F)
- CLS200 pressure (vessel):
 - rod version 0 to 25 bar, gauge/365 psi, gauge/2500 kPa, gauge (nominal)
 - cable version 0 to 10 bar, gauge/150 psi, gauge/1000 kPa, gauge (nominal)

¹. At process connection.

- CLS300 temperature¹:
 - rod/cable version -40 to +200 °C (-40 to +185 °F)
 - high-temperature version -40 to +400 °C (-40 to +752 °F)
- CLS300 pressure (vessel):
 - 1 to +35 bar, gauge (-14.6 to +511 psi g)

Power

General Purpose and Explosion Proof: 12 to 250 V AC/DC, 2 VA/2W max.

Installation

Notes:

- Installation shall only be performed by qualified personnel and in accordance with local governing regulations.
- This product is susceptible to electrostatic shock. Follow proper grounding procedures.
- This housing may only be opened for maintenance, local operation, or electrical installation.
- Before installing the instrument, verify that the environment complies with any restrictions specified on the device nameplate.

Handling Precautions

! **WARNING: To prevent damage, all CLS200 Standard units with a rod longer than 2 m (6.5 ft) must be handled as described below.**

When lifting CLS200 from a horizontal position, support it at these three points:

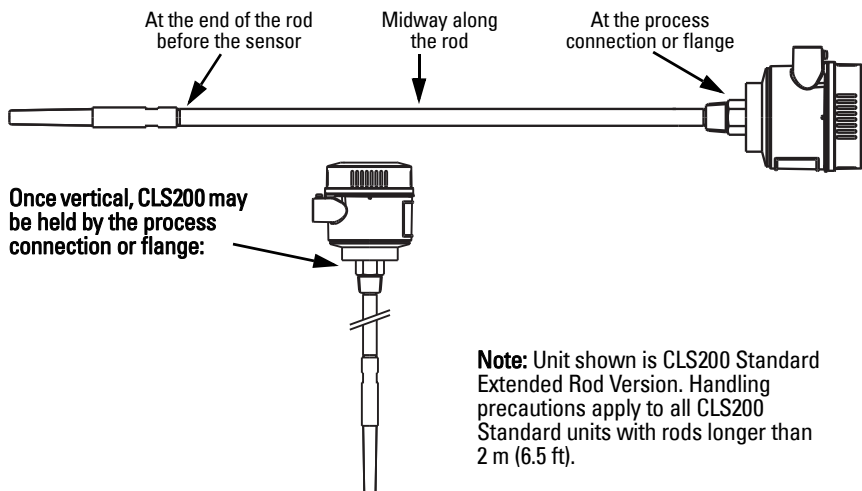

¹. At process connection.

Mounting Location

Notes:

- Keep the sensor at least 50 mm (2") away from any nozzle or tank wall.
- If multiple units are used, allow at least 100 mm (4") between them, to prevent interference (mount diagonally if space is restricted).
- Do: provide a sun shield to protect the transmitter from direct heat radiation.
- Do not: exceed the permissible ambient temperature limits
- Do not: mount Pointek CLS200/300 in locations subject to strong vibrations (if it can be avoided).

Standard probe length: top or side mounting

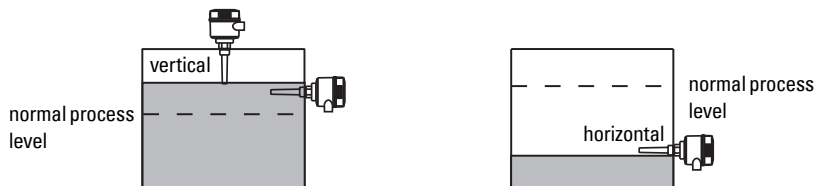

High level alarm

- normally mounted into the vessel top, or
- through the tank wall at the detection level

Low level alarm

- mounted through the tank wall at the detection level

Standard configuration with extensions: top mounting

- Designed for top mounting, for high or low level alarm. Suspend the probe vertically so that it reaches into the process at the desired detection level.

Process Cautions

- The maximum allowable torque on a horizontally installed rod is 15 Nm.
- Keep unit out of path of falling material, or protect probe from falling material.
- Avoid areas where material build up occurs.
- Take into account material surface configuration when installing unit.
- Ensure tensile load does not exceed probe or vessel ratings

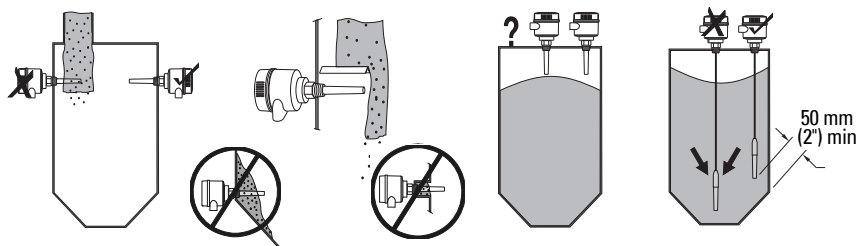

Mounting Instructions

Pointek CLS200/300 is available in three thread types: NPT, or BSPT (R), and BSPP (G)¹. Make sure the mounting connection threads are of the same type, then simply screw the device into the process connection, and hand tighten.

¹. A sanitary connection is also available.

Wiring



WARNING: All field wiring must have insulation suitable for at least 250 V.

Notes:

- Only qualified personnel are authorized to install and operate this equipment in accordance with established safety practices and standards.
 - The Protective Earth Terminal indicated by  must be connected to reliable ground.
 - All wiring must be done by qualified personnel in accordance with all governing regulations.
 - The equipment must be protected by a 15A fuse or circuit breaker in the building installation.
 - A circuit breaker or switch in the building installation, marked as a disconnect switch, shall be in close proximity to the equipment and within easy reach of the operator.
 - Use shielded cable, wire gauge 20 AWG to 14 AWG (0.5 mm² to 2.0 mm²). Use a cable with a braided metallic shield for CE installations (or armoured cable where applicable).
 - Maximum working voltage between adjacent relay contacts is 250 V.
 - Relay contact terminals are for use with equipment which has no accessible live parts and wiring which has insulation suitable for at least 250 V.
1. Loosen the lid clip and remove the lid to access the connectors and electronics. (The diagram on the next page can also be found on the underside of the lid, together with a guide to switch function).
 2. Connect the wires to the terminals (polarity is not important).
 3. Ground the instrument according to local regulations.
 4. Tighten the gland to form a good seal.
 5. After adjusting the settings, replace the lid and secure the lid clip.

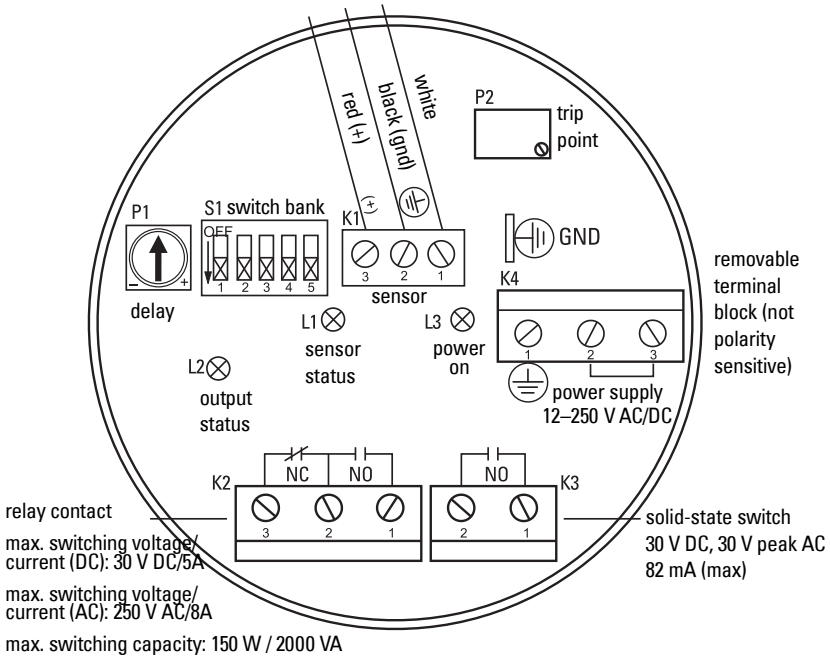

Note: Switch and potentiometer settings are for illustration purposes only.

CLS200 and CLS300 Relay Output Connection and Solid-state Switch Connection

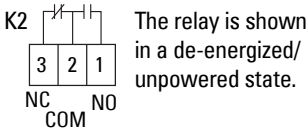

K2 contact ratings:

- max. switching voltage/current (DC): 250 V AC/8 A
- max. switching voltage/current (DC): 30 V DC/5 A

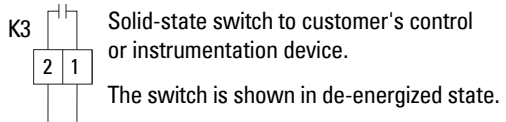

K3 contact ratings:

- max. voltage: 30 V DC, 30 V peak AC
- max. current: 82 mA
- non-polarized

Diode Protection

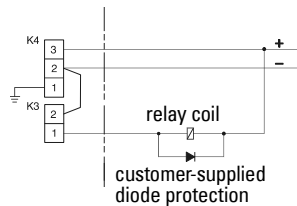
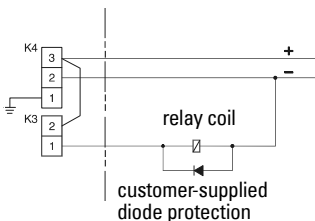

Operation: CLS200

User Interface:

Potentiometers **P1** and **P2**

Switch Bank **S1** to **S5**

Indicators: **L1** to **L3**

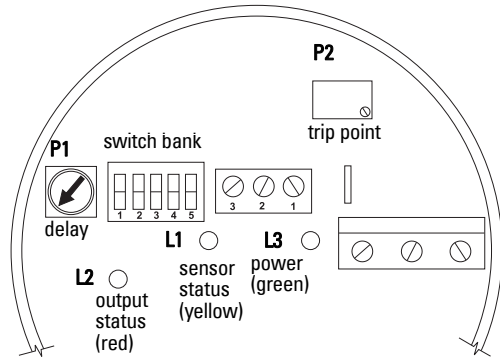

The alarm delay and trip point settings can be adjusted, using indicators **L1**, **L2** and **L3** to help set potentiometers **P1** and **P2**.

LED status	L1 (yellow)	L2 (red)	L3 (green)
Lit	sensor contacting, or very close to, process material (material capacitance greater than setpoint for P2)	alarm OFF (relay energized/ switch closed)	power ON
Unlit	sensor not contacting process material (material capacitance less than setpoint for P2)	alarm ON (relay de-energized/ switch open)	no power

Alarm Output

The Failsafe function controls the response of Pointek CLS200 to a fault, so that it puts the process into a safe mode of operation. (For more details, please refer to the full manual.)

Relay and solid-state switch functionality (see S3 below)

Alarm Mode	Dip Switch	Covered Probe	Uncovered Probe
High (Failsafe High)	S3 ON 		
Low (Failsafe Low)	S3 OFF 		

Switch Bank

4 dip switches (**S1**, **S2**, **S3**, and **S5**) control settings for the alarm output.

The fifth dip switch (**S4**) is used only to test the delay settings.

When **S3** is set to ON, it inverts the relay function, and the functioning of **S1** and **S2**.

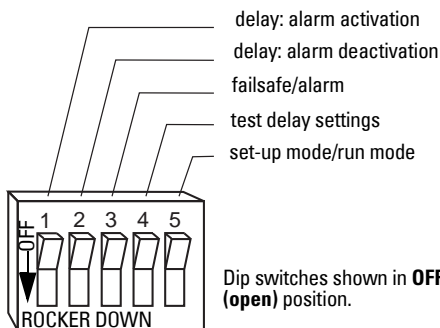

Dip switches shown in **OFF (open)** position.

Failsafe/Alarm Setting¹: S3

Alarm Mode	S3 status	Probe status	Alarm status	Relay status
High	ON	covered	activated (ON)	de-energized
Low	OFF	uncovered	activated (ON)	de-energized

Delay Settings: S1 and S2

Effect of S3 position on functioning of S1 and S2			
S3-ON	High alarm/ overflow protection	S1-ON	disables delay of alarm de-activation (alarm OFF)
		S2-ON	disables delay of alarm activation (alarm ON)
S3-OFF	Low alarm/dry run protection	S1-ON	disables delay of alarm activation (alarm ON)
		S2-ON	disables delay of alarm de-activation (alarm OFF)

Setup mode/run mode: S5

S5-ON	Setup mode	Used only during trip-point setup.
S5-OFF	Run mode	Used during normal operation (run mode) after setup is complete.

Test settings: S4 (inverts the signal).

S4-ON	Enable test	Check output status and sensor status LEDs to verify delay interval set by potentiometer P1.
S4-OFF	Normal operation	

¹ The manual assumes that the pump should be turned off in the event of a failure. If this is not the case in your process, make the appropriate connections to suit your application.

Setup (Low alarm/no delays: default setting)

! WARNING: It is essential to check settings during the process itself, and confirm that they are correct, before regular operation commences.

Initial setup can be carried out prior to mounting into the process, but it is extremely important to calibrate the unit and adjust the sensitivity on the product itself.

Setpoint Adjustment

Note: For more detailed instructions, please see the full manual.

Select the application type most similar to your operation, and adjust the setup conditions accordingly.

Application	Material	Setup conditions
General	<ul style="list-style-type: none"> • dry solids • low viscosity liquids 	sensor uncovered; min. 100 mm (4") free space all around
Demanding	<ul style="list-style-type: none"> • hygroscopic / wet solids • high viscosity and high conductivity liquids 	sensor immersed then uncovered; but retaining max. possible material buildup
Interface detection	<ul style="list-style-type: none"> • liquid A / liquid B • foam / liquid 	immerse sensor in whichever material has lowest dielectric constant

Set trip point

1. Ensure the green power LED L3 is on.
2. Set dip switch S5 ON (set-up mode).
3. Ensure the probe is setup conditions match the table above.
4. If the yellow sensor status LED L1 is not on, turn the trip-point potentiometer P2 counter-clockwise until it just turns on.
5. Turn the trip-point potentiometer P2 clockwise until LED L1 just turns off.
6. Set dip switch S5 OFF (run mode).

Set delay interval

1. Turn **P1** clockwise to set the delay interval.
2. Set **S1** and/or **S2** to OFF, to enable the delay for alarm activation/alarm de-activation. Check the delay, using **S4** to invert the signal.

If an immediate alarm output is critical, set the appropriate switch to ON, to disable the delay.

Operation: CLS300

User Interface:

Potentiometers **P1** and **P2**

Switch Bank **S1** to **S5**

Indicators: **L1** to **L3**

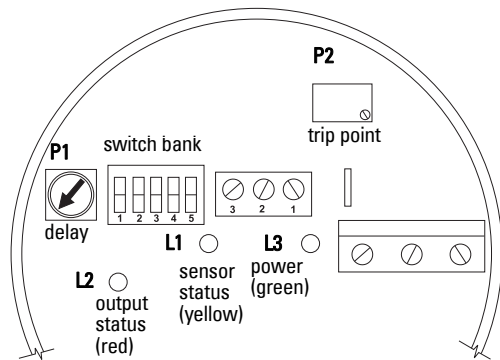

The alarm delay and trip point settings can be adjusted, using indicators **L1**, **L2** and **L3** to help set potentiometers **P1** and **P2**.

LED status	L1 (yellow)	L2 (red)	L3 (green)
Lit	sensor contacting, or very close to, process material (material capacitance greater than setpoint for P2)	alarm OFF (relay energized/ switch closed)	power ON
Unlit	sensor not contacting process material (material capacitance less than setpoint for P2)	alarm ON (relay de-energized/ switch open)	no power

Alarm Output

The Failsafe function controls the response of Pointek CLS300 to a fault, so that it puts the process into a safe mode of operation. (For more details, please refer to the full manual.)

Relay and solid-state switch functionality (see S3 below)

Alarm Mode	Dip Switch	Covered Probe	Uncovered Probe
High (Failsafe High)	S3 ON 	 relay switch L2 (unlit)	 relay switch L2 (lit)
Low (Failsafe Low)	S3 OFF 	 relay switch L2 (lit)	 relay switch L2 (unlit)

Switch Bank

4 dip switches (**S1**, **S2**, **S3**, and **S5**) control settings for the alarm output.

The fifth dip switch (**S4**) is used only to test the delay settings.

When **S3** is set to ON, it inverts the relay function, and the functioning of **S1** and **S2**.

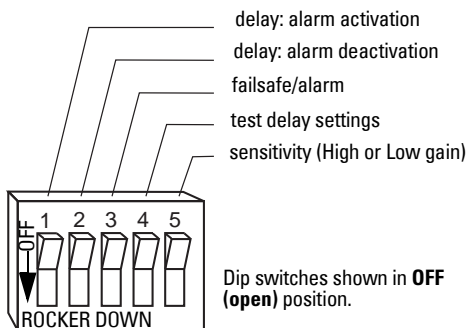

Dip switches shown in **OFF (open)** position.

Failsafe/Alarm Setting¹: S3

Alarm Mode	S3 status	Probe status	Alarm status	Relay status
High	ON	covered	activated (ON)	de-energized
Low	OFF	uncovered	activated (ON)	de-energized

Delay Settings: S1 and S2

Effect of S3 position on functioning of S1 and S2			
S3-ON	High alarm/overfill protection	S1-ON	disables delay of alarm de-activation (alarm OFF)
		S2-ON	disables delay of alarm activation (alarm ON)
S3-OFF	Low alarm/dry run protection	S1-ON	disables delay of alarm activation (alarm ON)
		S2-ON	disables delay of alarm de-activation (alarm OFF)

Sensitivity setting (high or low): S5

S5-ON	High	For measuring dry solids or non-conductive liquids.
S5-OFF	Low	For measuring conductive liquids, or viscous conductive solids

Test settings: S4 (inverts the signal).

S4-ON	Enable test	Check output status and sensor status LEDs to verify delay interval set by potentiometer P1.
S4-OFF	Normal operation	

¹ The manual assumes that the pump should be turned off in the event of a failure. If this is not the case in your process, make the appropriate connections to suit your application.

Setup (Low alarm/no delays: default setting)

! WARNING: It is essential to check settings during the process itself, and confirm that they are correct, before regular operation commences.

Initial setup can be carried out prior to mounting into the process, but it is extremely important to calibrate the unit and adjust the sensitivity on the product itself.

- turn **P1** fully counter-clockwise (no delay interval).
- set dip switches **S1**, **S2**, and **S5** to ON; **S3** and **S4** to OFF.
- apply power to the unit: Pointek CLS300 is operational.

Setpoint Adjustment.

Note: For more detailed instructions, please see the full manual.

Select the application type most similar to your operation, and adjust the setup conditions and sensitivity (**S5**) accordingly.

Application	Material	Setup conditions	S5
General	<ul style="list-style-type: none"> • dry solids • low viscosity liquids 	sensor uncovered; min. 100 mm (4") free space all around	ON (high)
Demanding	<ul style="list-style-type: none"> • hygroscopic / wet solids • high viscosity and high conductivity liquids 	sensor immersed then uncovered; but retaining max. possible material buildup	OFF (low)
Interface detection	<ul style="list-style-type: none"> • liquid A / liquid B • foam / liquid 	immerse sensor in whichever material has lowest dielectric constant	OFF (low)

Set trip point

1. If the yellow sensor light **L1** is on, turn **P2** clockwise until it turns off.
2. Slowly turn **P2** counter-clockwise until sensor light **L1** (yellow) glows.
3. Turn **P2** back (clockwise) until **L1** stops glowing.

Set delay interval

1. Turn **P1** clockwise to set the delay interval.
2. Set **S1** and/or **S2** to OFF, to enable the delay for alarm activation/alarm de-activation. Check the delay, using **S4** to invert the signal.

If an immediate alarm output is critical, set the appropriate switch to ON, to disable the delay.

Maintenance

Pointek CLS200/300 requires no maintenance or cleaning.

Instructions specific to hazardous area installations (Reference European ATEX Directive 94/9/EC, Annex II, 1/0/6)

The following instructions apply to equipment covered by certificate number KEMA 00ATEX2039X and KEMA 00ATEX2040X:

1. For use and assembly, refer to the main instructions.
2. The equipment is certified for use as Category 1/2G, 1/2D. Refer to appropriate certificate.
3. Refer to appropriate certificate for application in specific hazardous environment.
4. Refer to appropriate certificate for ambient temperature range.
5. The equipment has not been assessed as a safety related device (as referred to by Directive 94/9/EC Annex II, clause 1.5).
6. Installation and inspection of this equipment shall be carried out by suitably trained personnel in accordance with the applicable code of practice (EN 60079-14 and EN 60079-17 in Europe).
7. Repair of this equipment shall be carried out by suitably trained personnel in accordance with the applicable code of practice (e.g. EN 60079-19 within Europe).
8. Components to be incorporated into or used as replacements in the equipment shall be fitted by suitably trained personnel in accordance with the manufacturer's documentation.
9. The certificate numbers have an 'X' suffix, which indicates that special conditions for safe use apply. Those installing or inspecting this equipment must have access to the certificates
10. If the equipment is likely to come into contact with aggressive substances, then it is the responsibility of the user to take suitable precautions that prevent it from being adversely affected, thus ensuring that the type of protection is not compromised.

Aggressive substances: e.g. acidic liquids or gases that may attack metals, or solvents that may affect polymeric materials.

Suitable precautions: e.g. establishing from the material's data sheet that it is resistant to specific chemicals.

Note: Please see www.siemens.com/pointek for the latest approval certificates.

Unit Repair and Excluded Liability

For detailed information, please see the inside back cover.

Notes

CLS200 Standard

SIEMENS		Standard
POINTEK CLS200 7MLxxxx-xxxx-xxxx [BOX 1][BOX 2] Serial No.: GYZ / S1034567 Input: 12 – 250 V $\overline{\sim}$, Max. 2 W, 0 - 60 Hz Amb. Temp.: -40 °C to 85 °C Encl.: [BOX 1] Cable Entry: [BOX 2]		

SIEMENS		Standard
POINTEK CLS200 7MLxxxx-xxxx-xxxx [BOX 1][BOX 2] Serial No.: GYZ / S1034567 Input: 12 – 250 V $\overline{\sim}$, Max. 2 W, 0 - 60 Hz Amb. Temp.: -40 °C to 85 °C Encl.: [BOX 1] Cable Entry: [BOX 2]		
 	Siemens Milltronics Process Instruments Inc.	

SIEMENS		Standard
POINTEK CLS200 7MLxxxx-xxxx-xxxx [BOX 1][BOX 2] Serial No.: GYZ / S1034567 Input: 12 – 250 V $\overline{\sim}$, Max. 2 W, 0 - 60 Hz Encl.: [BOX 1] Cable Entry: [BOX 2]		
 	II 1/2 G EEx d [ja] IIC T6...T4 1/2 D T100°C KEMA 00ATEX2039 X N117	
Use Suitably Rated Cable If Ambient Temp. > 70 °C Refer To Applicable Certificate For Temp. Rating Do Not Open When An Explosive Atmosphere Is Present		

SIEMENS		Standard
POINTEK CLS200 7MLxxxx-xxxx-xxxx [BOX 1][BOX 2] Serial No.: GYZ / S1034567 Input: 12 – 250 V $\overline{\sim}$, Max. 2 W, 0 - 60 Hz Amb. Temp.: -40 °C to 85 °C Encl.: [BOX 1] Cable Entry: [BOX 2]		
 	Ex II 1/2 D T100°C KEMA 00ATEX2039 X N117	
Use Suitably Rated Cable If Ambient Temp. > 70 °C Do Not Open When An Explosive Dust Atmosphere Is Present		

SIEMENS		Standard
POINTEK CLS200 7MLxxxx-xxxx-xxxx [BOX 1][BOX 2] Serial No.: GYZ / S1034567 Input: 12 – 250 V $\overline{\sim}$, Max. 2 W, 0 - 60 Hz Amb. Temp.: -40 °C to 85 °C Encl.: [BOX 1] Cable Entry: [BOX 2]		
 	Class I, Div 1, Gr. A, B, C, D Class II, Div 1, Gr. E, F, G Class III T4 Seal Conduit < 18 inches Use Suitably Rated Cable If Ambient Temp. > 70 °C Do Not Open When An Explosive Atmosphere Is Present	

SIEMENS		Standard
POINTEK CLS200 7MLxxxx-xxxx-xxxx [BOX 1][BOX 2] Serial No.: GYZ / S1034567 Input: 12 – 250 V $\overline{\sim}$, Max. 2 W, 0 - 60 Hz Amb. Temp.: -40 °C to 85 °C Encl.: [BOX 1] Cable Entry: [BOX 2]		
 	Class II, Div 1, Gr. E, F, G Class III T4 Do Not Open When An Explosive Dust Atmosphere Is Present	

SIEMENS		Standard
POINTEK CLS200 7MLxxxx-xxxx-xxxx [BOX 1][BOX 2] Serial No.: GYZ / S1034567 Input: 12 – 250 V $\overline{\sim}$, Max. 2 W, 0 - 60 Hz Encl.: [BOX 1] Cable Entry: [BOX 2]		
 	Segurança Ex d [ja Ga] IIC T6 ... T4 Gb Ex tb IIC T85 °C ... T100 °C Db DNV 12.0072 X ATENÇÃO - NÃO ABRA ONDE UMA ATMOSFERA EXPLOSIVA POSSA ESTAR PRESENTE ATENÇÃO - UTILIZAR CABOS ADEQUADOS PARA TEMPERATURA AMBIENTE > 70° C Siemens Milltronics Process Instruments, Peterborough	

Bemærk: Oplysningerne i boksene 1 til 7 ændres på basis af kundens ordre.

Dansk

CLS300 Standard

SIEMENS	
POINTEK CLS300 7MLxxxx-xxxx-xxxx [BOX 1][BOX 2] Serial No.: GYZ / S1034567 Input: 12 – 250 V Max. 2 W, 0 - 60 Hz Amb. Temp.: – 40 °C to 85 °C Encl.: [BOX 1] Cable Entry: [BOX 2]	Standard

SIEMENS	
POINTEK CLS300 7MLxxxx-xxxx-xxxx [BOX 1][BOX 2] Serial No.: GYZ / S1034567 Input: 12 – 250 V Max. 2 W, 0 - 60 Hz Amb. Temp.: – 40 °C to 85 °C Encl.: [BOX 1] Cable Entry: [BOX 2]	Standard Class II, Div 1, Gr. E, F, G Class III T4 Do Not Open When An Explosive Dust Atmosphere Is Present

SIEMENS	
POINTEK CLS300 7MLxxxx-xxxx-xxxx [BOX 1][BOX 2] Serial No.: GYZ / S1034567 Input: 12 – 250 V Max. 2 W, 0 - 60 Hz Amb. Temp.: – 40 °C to 85 °C Encl.: [BOX 1] Cable Entry: [BOX 2]	Standard

Siemens Milltronics Process Instruments Inc.

SIEMENS	
POINTEK CLS300 7MLxxxx-xxxx-xxxx [BOX 1][BOX 2] Serial No.: GYZ / S1034567 Input: 12 – 250 V Max. 2 W, 0 - 60 Hz Amb. Temp.: – 40 °C to 85 °C Encl.: [BOX 1] Cable Entry: [BOX 2]	Standard Class I, Div 1, Gr. A, B, C, D Class II, Div 1, Gr. E, F, G Class III T4 Seal Conduit < 18 inches Use Suitably Rated Cable If Ambient Temp. > 70 °C Do Not Open When An Explosive Atmosphere Is Present

SIEMENS	
POINTEK CLS300 7MLxxxx-xxxx-xxxx [BOX 1][BOX 2] Serial No.: GYZ / S1034567 Input: 12 – 250 V Max. 2 W, 0 - 60 Hz Amb. Temp.: – 40 °C to 85 °C Encl.: [BOX 1] Cable Entry: [BOX 2]	Standard KEMA 00ATEX2040 X

Use Suitably Rated Cable If Ambient Temp. > 70 °C
Do Not Open When An Explosive Dust Atmosphere Is Present

SIEMENS	
POINTEK CLS300 7MLxxxx-xxxx-xxxx [BOX 1][BOX 2] Serial No.: GYZ / S1034567 Input: 12 – 250 V Max. 2 W, 0 - 60 Hz Encl.: [BOX 1] Cable Entry: [BOX 2]	Standard Segurança Ex d [Ia Ga] IIC T6...T4 Gb Ex tb IIC T85 °C...T100 °C Db DNV 12.0073 X ATENÇÃO - NÃO ABRA ONDE LIMA ATMOSFERA EXPLOSIVA POSSA ESTAR PRESENTE ATENÇÃO - UTILIZAR CABOS ADEQUADOS PARA TEMPERATURA AMBIENTE > 70 °C Siemens Milltronics Process Instruments, Peterborough

SIEMENS	
POINTEK CLS300 7MLxxxx-xxxx-xxxx [BOX 1][BOX 2] Serial No.: GYZ / S1034567 Input: 12 – 250 V Max. 2 W, 0 - 60 Hz Encl.: [BOX 1] Cable Entry: [BOX 2]	Standard KEMA 00ATEX2040 X

Use Suitably Rated Cable If Ambient Temp. > 70 °C
Refer To Applicable Certificate For Temp. Rating
Do Not Open When An Explosive Atmosphere Is Present

Bemærk: Oplysningerne i boksene 1 til 7 ændres på basis af kundens ordre.