

# Capacitance Switches

Pointek CLS200/CLS300 (Digital)

Quick Start Manual · 03/2013



**SIEMENS**







## CLS200 (Digital)

**SIEMENS** Digital

POINTEK CLS200  
7MLxxxx-xxxx-xxxx [Box 1][Box 2]

Serial No.: GYZ / S1034567  
Input: Profibus PA, 12 – 30 V  
Amb. Temp.: – 40 °C to 85 °C  
Encl.: [Box 1]  
Cable Entry: [Box 2]  
Output: Solid State Relay,  
30 V ~, 82 mA



   
N117  
159134

   
FM APPROVED

**SIEMENS** Digital

POINTEK CLS200  
7MLxxxx-xxxx-xxxx [Box 1][Box 2]

Serial No.: GYZ / S1034567  
Input: Profibus PA, 12 – 24 V  
12.5 mA  
Encl.: [Box 1]  
Cable Entry: [Box 2]  
Output: Solid State Relay,  
30 V ~, 82 mA

    
N117



 II 1 G EEx ia IIC T6...T4  
112 D IP6X T100°C  
KEMA 03ATEX1008 X

Refer To Applicable Certificate For Temp. Rating

**SIEMENS** Digital

POINTEK CLS200  
7MLxxxx-xxxx-xxxx [Box 1][Box 2]

Serial No.: GYZ / S1034567  
Input: Profibus PA, 12 – 24 V  
12.5 mA  
Encl.: [Box 1]  
Cable Entry: [Box 2]  
Output: Solid State Relay,  
30 V ~, 82 mA

   
FM APPROVED

Class I, Div 1, Gr. A, B, C, D  
Class II, Div 1, Gr. E, F, G  
Class III T4  
Exia per dwg. A5E01175715



Refer to Applicable Certificate For Temp. Rating

**SIEMENS** Digital

POINTEK CLS200  
7MLxxxx-xxxx-xxxx [Box 1][Box 2]

Serial No.: GYZ / S1034567  
Input: Profibus PA, 12 – 30 V  
Encl.: [Box 1]  
Cable Entry: [Box 2]  
Output: Solid State Relay,  
30 V ~, 82 mA

 II 1/2 G,  
EEx d Iia IIC T6...T4  
112 D T100°C  
KEMA 00ATEX2039 X



    
N117

Use Suitably Rated Cable If Ambient Temp. > 70 °C  
Refer To Applicable Certificate For Temp. Rating  
Do Not Open When An Explosive Atmosphere Is Present

**SIEMENS** Digital

POINTEK CLS200  
7MLxxxx-xxxx-xxxx [Box 1][Box 2]

Serial No.: GYZ / S1034567  
Input: Profibus PA, 12 – 30 V  
Amb. Temp.: – 40 °C to 85 °C  
Encl.: [Box 1]  
Cable Entry: [Box 2]  
Output: Solid State Relay,  
30 V ~, 82 mA

   
FM APPROVED

Class II, Div 1, Gr. E, F, G  
Class III T4



Do Not Open When An Explosive Dust Atmosphere Is Present

**SIEMENS** Digital

POINTEK CLS200  
7MLxxxx-xxxx-xxxx [Box 1][Box 2]

Serial No.: GYZ / S1034567  
Input: Profibus PA, 12 – 30 V  
Encl.: [Box 1]  
Cable Entry: [Box 2]  
Output: Solid State Relay,  
30 V ~, 82 mA

 II 3 G Ex nA II T6...T4  
2 D IP6X T100°C  
KEMA 03ATEX1007 X



    
N117

Refer To Applicable Certificate For Temp. Rating

**SIEMENS** Digital

POINTEK CLS200  
7MLxxxx-xxxx-xxxx [Box 1][Box 2]

Serial No.: GYZ / S1034567  
Input: Profibus PA, 12 – 30 V  
Amb. Temp.: – 40 °C to 85 °C  
Encl.: [Box 1]  
Cable Entry: [Box 2]  
Output: Solid State Relay,  
30 V ~, 82 mA

   
FM APPROVED



Class I, Div 1, Gr. A, B, C, D  
Class II, Div 1, Gr. E, F, G  
Class III T4  
Seal Conduit < 18 inches

Use Suitably Rated Cable If Ambient Temp. > 70 °C  
Do Not Open When An Explosive Atmosphere Is Present

**SIEMENS** Digital

POINTEK CLS200  
7MLxxxx-xxxx-xxxx [Box 1][Box 2]

Serial No.: GYZ / S1034567  
Input: Profibus PA, 12 – 30 V  
Amb. Temp.: – 40 °C to 85 °C  
Encl.: [Box 1]  
Cable Entry: [Box 2]  
Output: Solid State Relay,  
30 V ~, 82 mA

   
FM APPROVED





Siemens Milltronics Process Instruments Inc.

**SIEMENS** Digital

POINTEK CLS200  
7MLxxxx-xxxx-xxxx [Box 1][Box 2]

Serial No.: GYZ / A1034567  
Input: Profibus PA, 12 – 30 V  
Encl.: [Box 1]  
Cable Entry: [Box 2]  
Output: Solid State Relay,  
30 V ~, 82 mA

   
FM APPROVED

Class I, Div 2, Gr. A, B, C, D  
Class II, Div 2, Gr. F, G  
Class III T4 or T6

Refer To Applicable Certificate For Temp. Rating

**SIEMENS** Digital

POINTEK CLS200  
7MLxxxx-xxxx-xxxx [Box 1][Box 2]

Serial No.: GYZ / S1034567  
Input: Profibus PA, 12 – 30 V  
Encl.: [Box 1]  
Cable Entry: [Box 2]  
Output: Solid State Relay,  
30 V ~, 82 mA



**Segurança**  
INMETRO 000907  
Ex d [Ia Ga] IIC T6 ... T4 Gb  
Ex tb IIC T85 °C ... T100 °C Db  
DNV 12.0072 X



ATENÇÃO - NÃO ABRA ONDE UMA ATMOSFERA EXPLOSIVA POSSA ESTAR PRESENTE  
ATENÇÃO - UTILIZAR CABOS ADEQUADOS PARA TEMPERATURA AMBIENTE > 70 °C

Siemens Milltronics Process Instruments, Peterborough

**SIEMENS** Digital

POINTEK CLS200  
7MLxxxx-xxxx-xxxx [Box 1][Box 2]

Serial No.: GYZ / S1034567  
Input: Profibus PA, 12 – 30 V  
Amb. Temp.: – 40 °C to 85 °C  
Encl.: [Box 1]  
Cable Entry: [Box 2]  
Output: Solid State Relay, 30 V ~, 82 mA





    
N117



 II 1/2 D T100°C  
KEMA 00ATEX2039 X



Use Suitably Rated Cable If Ambient Temp. > 70 °C  
Do Not Open When An Explosive Atmosphere Is Present



**Note:** Information in boxes 1 through 7 changes based on customer order.



## CLS300 (Digital)



SIEMENS		Digital
POINTEK CLS300		
7MLxxxx-xxxxx-xxxx [Box a][Box 7]		
Serial No.: GYZ / S1034567		
Input: Profibus PA, 12 – 30 V $\approx$		
Amb. Temp.: – 40 °C to 85 °C		
Encl.: [BOX 1]		
Cable Entry: [BOX 2]		
Output: Solid State Relay, 30 V $\approx$ , 82 mA		
   		



SIEMENS		Digital
POINTEK CLS300		
7MLxxxx-xxxxx-xxxx [Box a][Box 7]		
Serial No.: GYZ / S1034567		
Input: Profibus PA, 12 – 30 V $\approx$		
Amb. Temp.: – 40 °C to 85 °C		
Encl.: [BOX 1]		
Cable Entry: [BOX 2]		
Output: Solid State Relay, 30 V $\approx$ , 82 mA		
 		
Class II, Div 1, Gr. E, F, G Class III T4		
Do Not Open When An Explosive Dust Atmosphere Is Present		

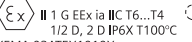

SIEMENS		Digital
POINTEK CLS300		
7MLxxxx-xxxxx-xxxx [Box a][Box 7]		
Serial No.: GYZ / S1034567		
Input: Profibus PA, 12 – 30 V $\approx$		
Amb. Temp.: – 40 °C to 85 °C		
Encl.: [BOX 1]		
Cable Entry: [BOX 2]		
Output: Solid State Relay, 30 V $\approx$ , 82 mA		
  		
KEMA 03ATEX1010 X		
Do Not Open When An Explosive Dust Atmosphere Is Present		



SIEMENS		Digital
POINTEK CLS300		
7MLxxxx-xxxxx-xxxx [Box a][Box 7]		
Serial No.: GYZ / S1034567		
Input: Profibus PA, 12 – 24 V $\approx$		
12.5 mA		
Encl.: [BOX 1]		
Cable Entry: [BOX 2]		
Output: Solid State Relay, 30 V $\approx$ , 82 mA		
 		
Class I, Div 1, Gr. A, B, C, D Class II, Div 1, Gr. E, F, G Class III T4		
Exia per dwg. A5E01175715		
Refer To Applicable Certificate For Temperature Rating		

SIEMENS		Digital
POINTEK CLS300		
7MLxxxx-xxxxx-xxxx [Box a][Box 7]		
Serial No.: GYZ / S1034567		
Input: Profibus PA, 12 – 24 V $\approx$		
12.5 mA		
Encl.: [BOX 1]		
Cable Entry: [BOX 2]		
Output: Solid State Relay, 30 V $\approx$ , 82 mA		
  		
KEMA 03ATEX1010X		
Refer To Applicable Certificate For Temp. Rating		

SIEMENS		Digital
POINTEK CLS300		
7MLxxxx-xxxxx-xxxx [Box a][Box 7]		
Serial No.: GYZ / S1034567		
Input: Profibus PA, 12 – 30 V $\approx$		
Amb. Temp.: – 40 °C to 85 °C		
Encl.: [BOX 1]		
Cable Entry: [BOX 2]		
Output: Solid State Relay, 30 V $\approx$ , 82 mA		
 		
Siemens Milltronics Process Instruments Inc.		

SIEMENS		Digital
POINTEK CLS300		
7MLxxxx-xxxxx-xxxx [Box a][Box 7]		
Serial No.: GYZ / S1034567		
Input: Profibus PA, 12 – 30 V $\approx$		
Amb. Temp.: – 40 °C to 85 °C		
Encl.: [BOX 1]		
Cable Entry: [BOX 2]		
Output: Solid State Relay, 30 V $\approx$ , 82 mA		
 		
Class I, Div 1, Gr. A, B, C, D Class II, Div 1, Gr. E, F, G Class III T4		
Seal Conduit < 18 inches		
Use Suitably Rated Cable If Ambient Temp. > 70 °C		
Do Not Open When An Explosive Atmosphere Is Present		

SIEMENS		Digital
POINTEK CLS300		
7MLxxxx-xxxxx-xxxx [Box a][Box 7]		
Serial No.: GYZ / S1034567		
Input: Profibus PA, 12 – 30 V $\approx$		
Encl.: [BOX 1]		
Cable Entry: [BOX 2]		
Output: Solid State Relay, 30 V $\approx$ , 82 mA		
 		
Ex d (ia Ga) IIC T6...T4 Gb Ex tb IIC T85 °C...T100 °C Db DNV 12.0073 X		
ATENÇÃO - NÃO ABRA ONDE UMA ATMOSFERA EXPLOSIVA POSSA ESTAR PRESENTE		
ATENÇÃO - UTILIZAR CABOS ADEQUADOS PARA TEMPERATURA AMBIENTE > 70 °C		
Siemens Milltronics Process Instruments, Peterborough		

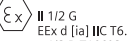
SIEMENS		Digital
POINTEK CLS300		
7MLxxxx-xxxxx-xxxx [Box a][Box 7]		
Serial No.: GYZ / S1034567		
Input: Profibus PA, 12 – 30 V $\approx$		
Encl.: [BOX 1]		
Cable Entry: [BOX 2]		
Output: Solid State Relay, 30 V $\approx$ , 82 mA		
  		
EEx d (ia) IIC T6...T4 1/2 D T100°C		
KEMA 00ATEX2040 X		
Use Suitably Rated Cable If Ambient Temp. > 70 °C		
Refer To Applicable Certificate For Temp. Rating		
Do Not Open When An Explosive Atmosphere Is Present		

**Note:** Information in boxes 1 through 7 changes based on customer order.

# Pointek CLS200/300 (Digital) Quick Start Manual

This manual outlines the essential features and functions of the Pointek CLS200/300. We strongly advise you to acquire the detailed version of the manual so you can use your instrument to its fullest potential. The complete manual is available at: [www.siemens.com/level](http://www.siemens.com/level). The printed manual is available from your Siemens Milltronics representative.

Questions about the contents of this manual can be directed to:

Siemens Milltronics Process Instruments  
1954 Technology Drive, P.O. Box 4225  
Peterborough, Ontario, Canada, K9J 7B1  
Email: [techpubs.smpi@siemens.com](mailto:techpubs.smpi@siemens.com)

**Copyright Siemens Milltronics  
Process Instruments 2013.  
All Rights Reserved**

**Disclaimer of Liability**

We encourage users to purchase authorized bound manuals, or to view electronic versions as designed and authored by Siemens Milltronics Process Instruments. Siemens Milltronics Process Instruments will not be responsible for the contents of partial or whole reproductions of either bound or electronic versions.

While we have verified the contents of this manual for agreement with the instrumentation described, variations remain possible. Thus we cannot guarantee full agreement. The contents of this manual are regularly reviewed and corrections are included in subsequent editions. We welcome all suggestions for improvement.

Technical data subject to change.

MILLTRONICS is a registered trademark of Siemens Milltronics Process Instruments

## Safety Guidelines

Warning notices must be observed to ensure personal safety as well as that of others, and to protect the product and the connected equipment. These warning notices are accompanied by a clarification of the level of caution to be observed:



**WARNING:** relates to a caution symbol on the product, and means that failure to observe the necessary precautions can result in death, serious injury, and/or considerable material damage.



**WARNING<sup>1</sup>:** means that failure to observe the necessary precautions can result in death, serious injury, and/or considerable material damage.

**CAUTION:** means that failure to observe the necessary precautions can result in considerable material damage.

**Note:** means important information about the product or that part of the operating manual.

<sup>1</sup> This symbol is used when there is no corresponding caution symbol on the product.

# Pointek CLS200/300 (Digital)

**Note:** Pointek CLS200/300 is to be used only in the manner outlined in this manual, otherwise protection provided by the equipment may be impaired.

**This product is intended for use in industrial areas. Operation of this equipment in a residential area may cause interference to several frequency based communications.**

Pointek CLS200/300 is a versatile capacitance switch with a high level of chemical resistance; ideal for level detection of interfaces, solids, liquids, slurries, and foam, and for simple pump control.

## Approvals (verify against device nameplate)

- CE, CSA<sub>C/US</sub>, FM, ATEX, INMETRO
- VlareM II, WHG
- Lloyd's Register of Shipping, categories ENV1, ENV2, and ENV5

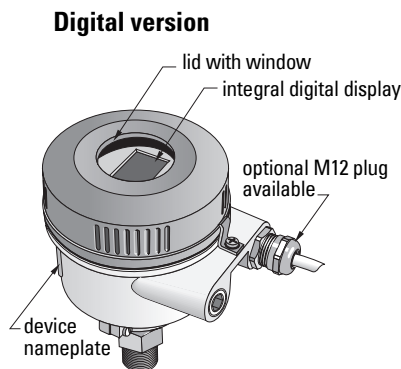

**Note:** The use of approved watertight conduit hubs/glands is required for Type 4 / NEMA 4, Type 6 / NEMA 6, IP68 (outdoor applications). For CE requirements, the use of EMC-rated cable entries is required for the CLS200.

## Process connections

Compact (std.) configuration	R ¾", 1", 1 1/4", 1 ½" BSPT; ¾", 1", 1 1/4", 1 ½" NPT; G ¾", 1", 1 ½" BSPP
Sanitary configuration	1", 1 ½", 2", 2 ½" and 3" tri-clamp
Cable and slide coupling configuration	R ¾", 1", 1 1/4", 1 ½" BSPT; ¾", 1", 1 1/4", 1 ½" NPT (Taper); G ¾", 1", 1 ½" BSPP

## Ambient temperature

- General applications
  - local display -40 to +85 °C (-40 to +185 °F)
  - storage temperature -30 to +85 °C (-22 to +185 °F)
- In potentially explosive atmospheres (check temperature class shown on device nameplate) -40 to +85 °C (-40 to +185 °F)

## Process Conditions

**Note:** Please see full Operating Instructions for Process Pressure/Temperature Derating Curves.

- relative dielectric constant ( $\epsilon_r$ ) 1.5 minimum
- CLS200 temperature<sup>1</sup>:
  - without thermal isolator -40 to +85 °C (-40 to +185 °F)
  - with thermal isolator -40 to +125 °C (-40 to +257 °F)

<sup>1</sup>. At process connection.

- CLS200 pressure (vessel):
  - rod version -1 to 25 bar g/-14.6 to 365 psi g
  - cable version -1 to 10 bar g/-14.6 to 150 psi g
- CLS300 temperature<sup>1</sup>:
  - rod/cable version -40 to +200 °C (-40 to +185 °F)
  - high-temperature version -40 to +400 °C (-40 to +752 °F)
- CLS300 pressure (vessel):
  - 1 to 35 bar g/-14.6 to 511 psi g

## Power

### Bus voltage

- General purpose 12 to 30 V DC, 12.5 mA
- Intrinsically Safe 12 to 24 V DC, 12.5 mA

## Installation

### Notes:

- Installation shall only be performed by qualified personnel and in accordance with local governing regulations.
- This product is susceptible to electrostatic shock. Follow proper grounding procedures.
- The housing may only be opened for maintenance, local operation, or electrical installation.
- Before installing the instrument, verify that the environment complies with any restrictions specified on the device nameplate.

## Handling Precautions

**! WARNING: To prevent damage, all CLS200 Digital units with a rod longer than 2 m (6.5 ft) must be handled as described below.**

**When lifting CLS200 from a horizontal position, support it at these three points:**

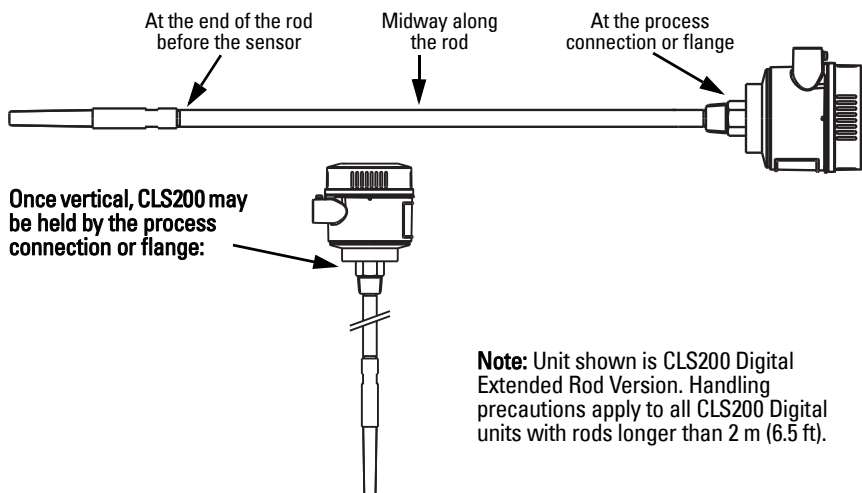

<sup>1</sup>. At process connection.

## Mounting Location

### Notes:

- Keep the sensor at least 50 mm (2") away from any nozzle or tank wall.
- If multiple units are used, allow at least 100 mm (4") between them, to prevent interference (mount diagonally if space is restricted).
- Do: provide a sun shield to protect the transmitter from direct heat radiation.
- Do not: exceed the permissible ambient temperature limits.
- Do not: mount Pointek CLS200/300 in locations subject to strong vibrations (if it can be avoided).

### Pointek CLS200/300 (standard probe length): top or side mounting

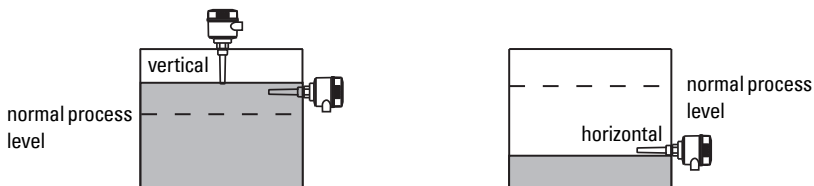

### High level alarm

- normally mounted into the vessel top, or
- through the tank wall at the detection level

### Low level alarm

- mounted through the tank wall at the detection level

### Standard configuration with extensions: top mounting

- Designed for top mounting, for high or low level alarm. Suspend the probe vertically so that it reaches into the process at the desired detection level.

## Process Cautions

- The maximum allowable torque on a horizontally installed rod is 15 Nm.
- Keep unit out of path of falling material, or protect probe from falling material.
- Avoid areas where material build up occurs.
- Take into account material surface configuration when installing unit.
- Ensure tensile load does not exceed probe or vessel ratings.

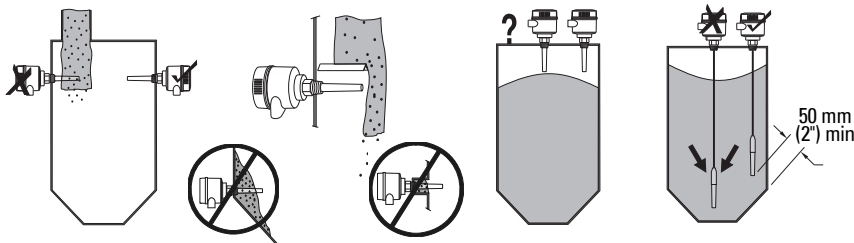

## Mounting Instructions

Pointek CLS200/300 is available in three thread types: NPT or BSPT (R) or BSPP (G)<sup>1</sup>. Make sure the mounting connection threads are of the same type, then simply screw Pointek CLS200/300 into the process connection, and hand tighten.

<sup>1</sup>. A sanitary connection is also available.



# Wiring: standalone unit

## Electrical Connection



### WARNING:

- Observe the specifications of the examination certificate valid in your country.
- Observe the laws and regulations valid in your country for electrical installations in potentially explosive atmospheres.
- Ensure that the available power supply complies with the power supply specified on the product nameplate and specified in the examination certificate valid in your country.
- Dust-proof protection caps in the cable inlets must be replaced by suitable screw-type glands or dummy plugs, which are appropriately certified for transmitters with explosion-proof protection.
- The lid must not be opened in wet locations while the unit is powered. (A wet location is location where water or another conductive fluid may be present and is likely to increase the risk of electric shock.)
- For CE installations use a cable with a braided metallic shield (or armoured cable where applicable).

### Power connection to screw terminals (standalone unit)

1. Loosen the lid clip and unscrew the lid of the enclosure.
2. Unscrew and lift up the digital display.
3. Connect the wires to the terminals: polarity is not important. (Terminal is removable.)
4. To use the Alarm Output, connect the wires of an optional input to the Alarm Output terminals: polarity is not important. (Terminal is removable.)
5. Ground the instrument according to local regulations<sup>1</sup>.
6. Tighten the gland to form a good seal.

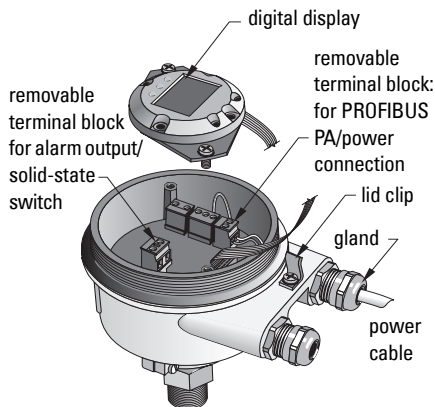

<sup>1</sup> The usual PROFIBUS PA recommendation is to ground the shield on both the device side and the cable side. In some cases it may be preferable to ground one side only, to avoid ground loops.

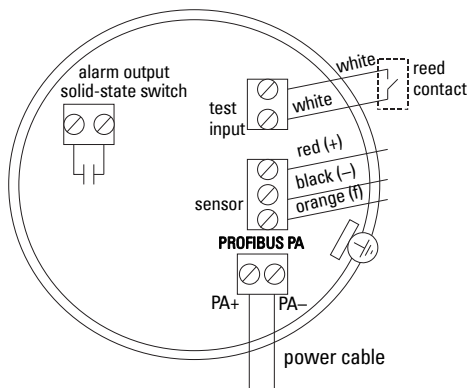

7. Replace the digital display.

8. To adjust the transmitter locally, use the keypad. (See *Setup using 3-button keypad* on page 9 and the Quick Reference table on page ). After adjustment, replace the enclosure lid and secure the lid clip.

## Operation

### Digital display

Selected in Mode 13: displays either the measured value, logical level, mode number and numerical value for the selected mode, or electronics temperature.

### Measured value display

- default display at startup
- value (in counts<sup>1</sup>) when Sensor (2) selected

### Logical level display (output status)

- value when OUT parameter of Discrete input function block (0) selected

### Bar graph



- represents extent to which sensor is covered
- displayed when one of the three following options is selected in Mode 13: the OUT parameter of the Discrete input function block; or the Primary Value of the Transducer Block; or the Sensor Value discrete of the Transducer Block

sensor uncovered

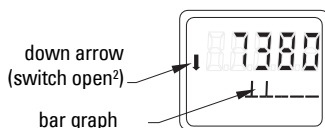

sensor covered

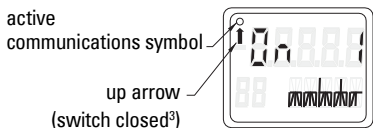

1. A dimensionless value generated from the inverse of frequency.

2. Switch function (open/closed) depends on setting at Mode 24.

3. Switch function (open/closed) depends on setting at Mode 24.

## Setup using 3-button keypad

**! WARNING: It is essential to check settings during the process itself, and confirm that they are correct, before regular operation commences.**

### Notes:

- See Quick Reference table on next page for Modes of Operation.
- Ensure HW Write Protection is disabled (Mode 10, page ).

Initial setup can be carried out prior to mounting into the process, but it is extremely important to calibrate the unit and adjust the sensitivity on the product itself.

- Flashing digit indicates cursor position.
- Press **M** to select a mode. Hold **M** and tap  $\uparrow$  to move backwards.
- To increment or decrement a value, press  $\uparrow$  or  $\downarrow$ .
- To move cursor to the right, press  $\downarrow$ .
- After editing the least-significant digit, press  $\downarrow$  to store the value.
- To enter a selection (not a numerical value) press **M**.

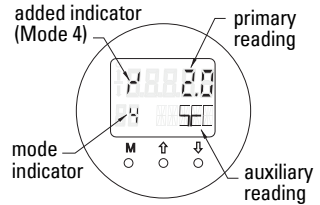

## Magnet-activated sensor test

Bring the bar magnet supplied close to the test area on the housing. After approximately 10 seconds, SENSOR TEST SUCCESSFUL, or SENSOR TEST FAILED, is displayed as rolling text.



## Error message display

Please see the full manual for details.

# Notes

---

## Quick Reference: operating functions using input keypad

Function, (parameter in PDM)	Mode	Key function			Display/ explanation
	<b>M</b> <sup>1</sup>	↑	↓	↑ and ↓	
Measured value display <sup>2</sup>					Default startup display; or if Sensor selected in Mode 13
Error display					Error, if transmitter is disturbed
Sensor test	2 *	Either key activates test			Displays GOOD or FAIL D
Rise Time	4	Open Edit mode, or increment digit.	Move cursor to right, or decrement digit, or store edited value.		t <sub>r</sub> <sup>1</sup> and value (seconds) Range: 0.0 to 100.0 s
Fall Time	5	Open Edit mode, or increment digit.	Move cursor to right, or decrement digit, or store edited value.		t <sub>f</sub> <sup>1</sup> and value (seconds) Range: 0.0 to 100.0 s
HW Write Protection	10 *	Either key enables Write Protection <sup>2</sup>			Hold for 5 seconds to disable <sup>3</sup> -- = disabled (parameter changes permitted) L = enabled (parameter changes inhibited)
Display Source	13 *	Increment or decrement value to make selection			<b>0</b> = OUT parameter; <b>1</b> = primary value; <b>2</b> = sensor; <b>3</b> = electronics temperature
Unit	14 *	Increment or decrement value to make selection.			Select °C; °F; °R, or K (if <b>3</b> selected in Mode 13).
Node address (PROFIBUS only)	15	Open Edit mode, or increment digit.	Move cursor to the right, or decrement digit, or store edited value.		Assign slave address on the PROFIBUS-line (0 to 126)
PROFIBUS Ident Number	16 *	Increment or decrement value to make selection.			Select device mode: according to profile; or, according to profile with full device specific support.
	<b>M</b> <sup>1</sup>	↑	↓	↑ and ↓	
0% Application Range setting	19	Open Edit mode, or increment digit.	Move cursor to the right, or decrement digit, or store edited value.		Adjust lower limit of application range.
100% Application Range setting	20	Open Edit mode, or increment digit.	Move cursor to the right, or decrement digit, or store edited value.		Adjust upper limit of application range.
Alarm output trigger	23 *	Increment or decrement value to make selection.			Select diagnostic interrupt ( <b>dIAG</b> ); process interrupt ( <b>OUT_d</b> ); disabled ( <b>OFF</b> ); or diagnostic alarm limit (set in PDM) exceeded ( <b>ALERT</b> )
Contact type	24 *	Increment or decrement value to make selection.			Set contact functionality in case of event: (logical inversion of alarm output switch) - Make contact ( <b>CLOSE</b> ) / Break contact ( <b>OPEn</b> )
Switch Point 1 (Rising Edge) OFF to ON	25	Open Edit mode, or increment digit.	Move cursor to the right, or decrement digit, or store edited value.		Set % of range at which switch will change from OFF to ON. (Hysteresis is a difference in value between Switch Point 1 and 2).
Switch Point 2 (Falling Edge) ON to OFF	26	Open Edit mode, or increment digit.	Move cursor to the right, or decrement digit, or store edited value.		Set % of range at which switch will change from ON to OFF. (Hysteresis is a difference in value between Switch Point 1 and 2).
Local Status Text	27 *	Increment or decrement value to make selection.			Select presentation of the status text.

1. Press ↓ to store numerical values; press **M** to store a selection (indicated by asterisk \*).
2. **L** appears in Mode indicator field if HW Write Protection is enabled.
3. If **L** or **LA** appear after disabling HW Write Protection, local operation is locked via the bus. Use PDM to disable this lock.



# Pointek CLS200/300 Digital unit on a PROFIBUS network

## Wiring: connection to a PROFIBUS PA network

**! WARNING: The requirements listed under WARNINGS on page 7 must be fulfilled.**

### Notes:

- Lay PA cable separately from power cable with voltages greater than 60 V AC.
- Avoid locating Pointek CLS200/300 near large electrical equipment wherever possible.
- Connect the cable shield to earth (for example, to the housing by means of a metallic screwed gland).

## PROFIBUS PA connection to screw terminals

Connect the PROFIBUS cable to the screw terminals, following the instructions on page 7.

## PROFIBUS PA connection via M12 plug

If an M12 plug is installed on the Pointek CLS200/300 enclosure, a female M12 receptacle is required on the end of the cable, to complete the bus connection to PROFIBUS PA.

The usual PROFIBUS PA recommendation is to ground the shield on both the device side and the cable side. In some cases (for example, on cathodically protected tanks), it may be preferable to ground one side only, to avoid ground loops.

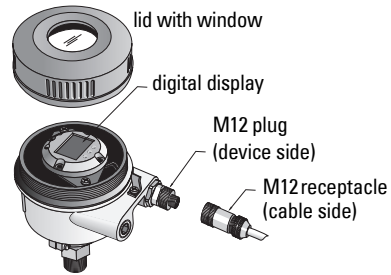

Follow the instructions accompanying the female receptacle.

Front view of pin insert and pins



thread M12 x 1

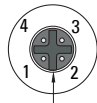

positioning lug

PIN	PROFIBUS PA
1	PA+
2	not connected
3	PA-
4	shield, connected to ground

**Pin assignment: device side**

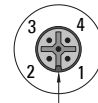

Front view of sleeve insert and sleeves

positioning nut

PIN	PROFIBUS PA
1	PA+
2	not connected
3	PA-
4	shield, connected to ground

**Pin assignment: cable side**

# Communications via PROFIBUS PA: Pointek CLS200/300 Digital model

## Notes:

- The following instructions assume that the user is familiar with PROFIBUS PA.
- For more detail, please see the full manual.

Pointek CLS200/300 is a Class B, Profile Version 3.0, PA device. It supports Class 1 Master for cyclic data exchange, and Class 2 for acyclic services.

To configure Pointek CLS200/300 we recommend SIMATIC Process Device Manager (PDM) by Siemens. (For more information go to > [www.siemens.com/simatic-pdm](http://www.siemens.com/simatic-pdm).)

## Device Description

To use PDM with PROFIBUS PA, you will need the Device Description (DD) for Pointek CLS200/300. Go to > **Device Catalog > Sensors/Level/Capacitive/Siemens Milltronics**, or download it from: [www.siemens.com/level](http://www.siemens.com/level) under **Downloads** on the Pointek CLS200/300 product page. After downloading the DD file, you need to execute DeviceInstall.

## Configuration

To configure a PROFIBUS Class 1 Master (for example, a PLC), you will need the **GSD** file, **SIEM80E9.GSD**. It can be downloaded from the Pointek CLS200/300 product page at: [www.siemens.com/level](http://www.siemens.com/level), under **Downloads**.

## Setting the PROFIBUS address

The factory setting for the PROFIBUS address is 126. Reset it locally using Mode 15 (see page ), or remotely via the bus, using a parameterization tool such as SIMATIC PDM or HW Config.

When cyclic data transfer with a Class 1 Master is in process, the address can only be changed via the bus.

## Bus Termination

**Note:** PROFIBUS PA line must be terminated at both extreme ends of the cable for it to work properly. Please refer to the PROFIBUS PA User and Installation Guidelines (order number 2.092), available from [www.profibus.com](http://www.profibus.com).

## Transmission of user data via PROFIBUS PA

The user data is the OUT parameter of the discrete input function block and is composed of the Logical Level and Status bytes.

### Logical Level

Inversion	Sensor Status	Logical Level
OFF	uncovered	= 0 (zero)
OFF	covered	= 1

### Status

- the usability of the measured value in the user program
- the device status (self-diagnosis/system diagnosis)
- additional process information (process alarms)

Please see the full manual for tables listing the codes for the Status byte.



# Configuring the user data

## Notes:

- To configure STEP 7, use HW Config.

The Discrete input function block supplies the content of the OUT parameter.

## Diagnosis

Pointek CLS200/300 can actively report information on its own status. Please see the full manual for a list of diagnostic messages.

## Remote Operation via PROFIBUS PA

To use PROFIBUS PA, you will need a PC configuration tool: we recommend SIMATIC PDM. You can download an application guide from the product page at [www.siemens.com/pointek](http://www.siemens.com/pointek). Also see the proprietary operating instructions or online help for details.

## Functions

Open the device menu (top left side of screen) for access to the following functions: upload from/download to the device; set address; master reset; write locking; sensor test via PROFIBUS PA; and simulation.

## Changing parameter settings

- First launch SIMATIC PDM, connect to Pointek CLS200/300, and upload data from the device.
- Adjust parameter values in the parameter view field (right side of screen).
- When you have completed the adjustments, open the **Device** menu, download data to the device, then save parameter settings offline.
- Go to **View – Display** to track the effects.

## Quick Setup

**! WARNING: It is essential to check settings during the process itself, and confirm that they are correct, before regular operation commences.**

**Note:** After adjusting values, download data to the device, then go to **View – Display** to track the effects.

Initial setup can be carried out prior to mounting into the process, but it is extremely important to calibrate the unit and adjust the sensitivity on the product itself.

### Adjust 0 % application range setting

Application	Material	Setup conditions
General applications	dry solids low viscosity liquids	Sensor uncovered and a minimum of 100 mm (4") free space all around
Demanding applications	hygroscopic / wet solids high viscosity and high conductivity liquids	Sensor immersed and then uncovered, but retaining as much build up of material as possible on the sensor.
Interface detection	liquid A / liquid B foam / liquid	Immerse the sensor in the material that has the lowest dielectric constant.

#### CLS200 Digital

1. Install the device in the process.
2. Open the menu **View – Display** and select the tab **Transducer Block: Discrete Input (Part 1)**. Make a note of the Sensor Value (digits) when the device is in the setup condition that most closely represents the process (refer to table above).
3. Subtract 300 counts from the Sensor Value noted in step 2 and enter this new value in the parameter view field: **> Input > Transducer Block: Discrete Input > Range of Application > 0%**.

#### CLS300 Digital

1. Install the device in the process.
1. Open the menu **View – Display** and select the tab **Transducer Block: Discrete Input (Part 1)**. Make a note of the Sensor Value (digits) when the device is in the setup condition that most closely represents the process (refer to table above).
2. Enter the sensor value in the parameter view field: **> Input > Transducer Block: Discrete Input > Range of Application > 0%**.

## Adjust 100 % application range setting

Application	Material	Setup conditions
General applications	dry solids low viscosity liquids	Sensor fully covered
Demanding applications	hygroscopic / wet solids high viscosity and high conductivity liquids	Sensor fully covered
Interface detection	liquid A / liquid B foam / liquid	Immerse the sensor in the material that has the highest dielectric constant.

### CLS200 Digital

1. Open the menu **View – Display** and select the tab **Transducer Block: Discrete Input (Part 1)**. Make a note of the Sensor Value (digits) when the device is in the setup condition that most closely represents the process (refer to table above).
2. Add 1000 counts to the Sensor Value noted in step 1 and enter this new value in the parameter view field: **> Input > Transducer Block: Discrete Input > Range of Application > 100%**.

### CLS300 Digital

1. Open the menu **View – Display** and select the tab **Transducer Block: Discrete Input (Part 1)**. Make a note of the Sensor Value (digits) when the device is in the setup condition that most closely represents the process (refer to table above).
2. Enter the sensor value in the parameter view field: **> Input > Transducer Block: Discrete Input > Range of Application > 100%**.

## Switch Point adjustment

### CLS200 Digital

1. Define the application range (from tables above).
2. Open the menu **View–Display**, and select the tab **Transducer Block: Discrete Input (Part 1)**, to view the actual Sensor Value, the Sensor Value Discrete, the actual valid Switch Point and Hysteresis
3. Go to **Input > Transducer Block: Discrete Input > Switch behavior**.
  - Edit the value of Switch Point 1 (default 55%).
  - Edit the value of Switch Point 2 (default 45%) to adjust the Hysteresis.

**Note:** A minimum hysteresis (difference between the Off to On switch point and the On to Off switch point) of 10% must be maintained for reliable operation. In some situations it may be desirable to increase the hysteresis between the two switch points to prevent false tripping (e.g. turbulence in the process).

### CLS300 Digital

1. Define the application range (from tables above).
2. Open the menu **View–Display**, and select the tab **Transducer Block: Discrete Input (Part 1)**, to view the actual Sensor Value, the Sensor Value Discrete, the actual valid Switch Point and Hysteresis
3. Go to **Input > Transducer Block: Discrete Input > Switch behavior**.
  - Edit the value of Switch Point 1 (default 55%).
  - Edit the value of Switch Point 2 (default 45%) to adjust the Hysteresis.

## Delay

- **Rise Time (Off to On)** determines the delay of the signal flow from the moment the sensor becomes covered until the Primary Value is set.
- **Fall Time (On to Off)** determines the delay of the signal flow from the moment the sensor becomes uncovered until the Primary Value is reset.

The delay timers have a range of values from 0.0 to 100.0 seconds.

- Go to **Input > Transducer Block: Discrete Input > Delay > Rise Time (Off to On)** and set the value from 0 to 100 seconds.
- Go to **Fall Time (On to Off)**, and set the value from 0 to 100 seconds.

**Note:** If the sensor status changes before the delay interval is complete, the timer is reset to its initial value and restarted.

## Inversion

When Inversion Output = **On**, the level status undergoes a logical inversion.

- Go to **Output > Function Block: Discrete Input > Inversion Output > Off or On**

## Failsafe Mode

Go to **Output > Function Block: Discrete Input > Fail Safe Mode > Fail Safe Mode** and select one of the three options:

Failsafe Mode	Description
The default value is used as the output value.	The predefined preset safety value is output (status code U_075).
Store the last valid output value.	The last valid output value is output (status code U_071).
The calculated output value is incorrect.	The bad output value is accompanied by the status which the Transducer block assigns to it (B_0xx).

## Resetting

Open the Device Menu **Master Reset** and select one of the three options:

### Factory Reset (restart/cold startup)

Recreates the delivery status. It resets most parameters to the factory setting.

### Warm start (new start-up)

Disconnects then restarts Pointek CLS200/300. Communication is interrupted and re-established. Use it if, for example, the PROFIBUS address has been changed.

### Resetting the PROFIBUS address to 126

Please see the full manual for details.

## Local display and operation

1. Go to **Local Display and Operation > Local Operation**:

Lock options	Effect	Turn on/off	Digital display
HW Write Protection	Parameter changes using SIMATIC PDM and settings via local operation are both disabled. Independent of the other lock functions.	Keypad Mode 10	L
Write locking	Prevents parameter changes via the bus. Local operation is possible.	SIMATIC PDM (via Device Menu)	Lc
Local Operation	When disabled, no access is possible via the keypad. After a communication failure, local operation is automatically enabled 30 s later. Once communication is reestablished, the original setting for <b>Local Operation</b> is restored.	SIMATIC PDM	LA

Locking functions can be combined:

HW Write Protection	Write locking	Local Operation	Digital display
Off	Off	enabled	
On	On or Off	enabled or disabled	L
Off	Off	disabled	LA
Off	On	disabled	LL
Off	On	enabled	Lc

2. Go to **Local Display and Operation > Display source**:  
select either Output Value, Primary Value, Sensor Value, or Electronics Temperature.
3. Go to **Local Display and Operation > Local Status Text**:  
select a language, or numeric option.

## Sensor Test

Open the Device Menu to find and activate Sensor Test via PDM, and to see the results: (**test successful**, or **test failed**).

## Error Messages and References: PROFIBUS PA

**Note:** For more detail, please consult the PROFIBUS PA User and Installation Guideline (order number 2.092), available for download from [www.profibus.com](http://www.profibus.com).

## Instructions specific to hazardous area installations (Reference European ATEX Directive 94/9/EC, Annex II, 1/0/6)

The following instructions apply to equipment covered by certificate number KEMA 03ATEX1007X , KEMA 03ATEX1008X, KEMA 03ATEX1010X, KEMA 00ATEX2039X and KEMA 00ATEX2040X:

1. For use and assembly, refer to the main instructions.
2. The equipment is certified for use as Category 1G, 1/2G, 3G, 1/2D, 2D. Refer to appropriate certificate.
3. Refer to appropriate certificate for application in specific hazardous environment.
4. Refer to appropriate certificate for ambient temperature range.
5. The equipment has not been assessed as a safety related device (as referred to by Directive 94/9/EC Annex II, clause 1.5).
6. Installation and inspection of this equipment shall be carried out by suitably trained personnel in accordance with the applicable code of practice (EN 60079-14 and EN 60079-17 in Europe).
7. Repair of this equipment shall be carried out by suitably trained personnel in accordance with the applicable code of practice (e.g. EN 60079-19 within Europe).
8. Components to be incorporated into or used as replacements in the equipment shall be fitted by suitably trained personnel in accordance with the manufacturer's documentation.
9. The certificate numbers have an 'X' suffix, which indicates that special conditions for safe use apply. Those installing or inspecting this equipment must have access to the certificates.
10. If the equipment is likely to come into contact with aggressive substances, then it is the responsibility of the user to take suitable precautions that prevent it from being adversely affected, thus ensuring that the type of protection is not compromised.

Aggressive substances: e.g. acidic liquids or gases that may attack metals, or solvents that may affect polymeric materials.

Suitable precautions: e.g. establishing from the material's data sheet that it is resistant to specific chemicals.

**Note:** Please see [www.siemens.com/pointek](http://www.siemens.com/pointek) for the latest approval certificates.





## Maintenance



Pointek CLS200/300 requires no maintenance or cleaning.

## Unit Repair and Excluded Liability

For detailed information, please see the inside back cover.

## CLS200 (Digital)



SIEMENS		Digital
<b>POINTEK CLS200</b> 7MLxxxx-xxxx-xxxx [Box a][Box 7] Serial No.: GYZ / S1034567 Input: Profibus PA, 12 – 30 V === Amb. Temp.: – 40 °C to 85 °C Encl.: [BOX 1] Cable Entry: [BOX 2] Output: Solid State Relay, 30 V ~, 82 mA		
 N117  159134	 FM APPROVED	 CE

SIEMENS		Digital
<b>POINTEK CLS200</b> 7MLxxxx-xxxx-xxxx [Box a][Box 7] Serial No.: GYZ / S1034567 Input: Profibus PA, 12 – 24 V === 12,5 mA Encl.: [BOX 1] Cable Entry: [BOX 2] Output: Solid State Relay, 30 V ~, 82 mA		
 CE [Box 3]	 N117	 II 1 G EEx ia IIC T6...T4 112 D IP6X T100°C KEMA 03ATEX1008 X

Refer To Applicable Certificate For Temp. Rating

SIEMENS		Digital
<b>POINTEK CLS200</b> 7MLxxxx-xxxx-xxxx [Box a][Box 7] Serial No.: GYZ / S1034567 Input: Profibus PA, 12 – 24 V === 12,5 mA Encl.: [BOX 1] Cable Entry: [BOX 2] Output: Solid State Relay, 30 V ~, 82 mA		
 FM APPROVED	Class I, Div 1, Gr. A, B, C, D Class II, Div 1, Gr. E, F, G Class III T4 Exia per dwg. A5E01175715	



Refer to Applicable Certificate For Temp. Rating

SIEMENS		Digital
<b>POINTEK CLS200</b> 7MLxxxx-xxxx-xxxx [Box a][Box 7] Serial No.: GYZ / S1034567 Input: Profibus PA, 12 – 30 V === Encl.: [BOX 1] Cable Entry: [BOX 2] Output: Solid State Relay, 30 V ~, 82 mA		
 II 1/2 G, EEx d [Ia] IIC T6...T4 1/2 D T100°C KEMA 00ATEX2039 X	 CE [Box 3]	 N117

Use Suitably Rated Cable If Ambient Temp. > 70 °C  
Refer To Applicable Certificate For Temp. Rating  
Do Not Open When An Explosive Atmosphere Is Present



SIEMENS		Digital
<b>POINTEK CLS200</b> 7MLxxxx-xxxx-xxxx [Box a][Box 7] Serial No.: GYZ / S1034567 Input: Profibus PA, 12 – 30 V === Amb. Temp.: – 40 °C to 85 °C Encl.: [BOX 1] Cable Entry: [BOX 2] Output: Solid State Relay, 30 V ~, 82 mA		
 FM APPROVED	Class II, Div 1, Gr. E, F, G Class III T4	

Do Not Open When An Explosive Dust Atmosphere Is Present

SIEMENS		Digital
<b>POINTEK CLS200</b> 7MLxxxx-xxxx-xxxx [Box a][Box 7] Serial No.: GYZ / S1034567 Input: Profibus PA, 12 – 30 V === Encl.: [BOX 1] Cable Entry: [BOX 2] Output: Solid State Relay, 30 V ~, 82 mA		
 II 3 G Ex nA II T6...T4 2 D IP6X T100°C KEMA 03ATEX1007 X	 CE [Box 3]	 N117

Refer To Applicable Certificate For Temp. Rating

SIEMENS		Digital
<b>POINTEK CLS200</b> 7MLxxxx-xxxx-xxxx [Box a][Box 7] Serial No.: GYZ / S1034567 Input: Profibus PA, 12 – 30 V === Amb. Temp.: – 40 °C to 85 °C Encl.: [BOX 1] Cable Entry: [BOX 2] Output: Solid State Relay, 30 V ~, 82 mA		
 FM APPROVED	Class I, Div 1, Gr. A, B, C, D Class II, Div 1, Gr. E, F, G Class III T4 Seal Conduit < 18 inches Use Suitably Rated Cable If Ambient Temp. > 70 °C Do Not Open When An Explosive Atmosphere Is Present	



SIEMENS		Digital
<b>POINTEK CLS200</b> 7MLxxxx-xxxx-xxxx [Box a][Box 7] Serial No.: GYZ / S1034567 Input: Profibus PA, 12 – 30 V === Amb. Temp.: – 40 °C to 85 °C Encl.: [BOX 1] Cable Entry: [BOX 2] Output: Solid State Relay, 30 V ~, 82 mA		
 FM APPROVED	  N117 159134	Siemens Milltronics Process Instruments Inc.

SIEMENS		Digital
<b>POINTEK CLS200</b> 7MLxxxx-xxxx-xxxx [Box a][Box 7] Serial No.: GYZ / A1034567 Input: Profibus PA, 12 – 30 V === Encl.: [BOX 1] Cable Entry: [BOX 2] Output: Solid State Relay, 30 V ~, 82 mA		
 FM APPROVED	Class I, Div 2, Gr. A, B, C, D Class II, Div 2, Gr. F, G Class III T4 or T6	

Refer To Applicable Certificate For Temp. Rating

SIEMENS		Digital
<b>POINTEK CLS200</b> 7MLxxxx-xxxx-xxxx [Box a][Box 7] Serial No.: GYZ / S1034567 Input: Profibus PA, 12 – 30 V === Encl.: [BOX 1] Cable Entry: [BOX 2] Output: Solid State Relay, 30 V ~, 82 mA		
 <b>Segurança</b> INMETRO Ex d [Ia] G a IIC T6 ... T4 Gb Ex tb IIC T85°C ... T100°C Db DNV 12.0072 X		

ATENÇÃO – NÃO ABRA ONDE UMA ATMOSFERA EXPLOSIVA POSSA ESTAR PRESENTE  
ATENÇÃO – UTILIZAR CABOS ADEQUADOS PARA TEMPERATURA AMBIENTE > 70° C  
Siemens Milltronics Process Instruments, Peterborough





SIEMENS		Digital
<b>POINTEK CLS200</b> 7MLxxxx-xxxx-xxxx [Box a][Box 7] Serial No.: GYZ / S1034567 Input: Profibus PA, 12 – 30 V === Amb. Temp.: – 40 °C to 85 °C Encl.: [BOX 1] Cable Entry: [BOX 2] Output: Solid State Relay, 30 V ~, 82 mA		
 CE [Box 3]	 II 1/2 D T100°C KEMA 00ATEX2039 X	



Use Suitably Rated Cable If Ambient Temp. > 70 °C  
Do Not Open When An Explosive Dust Atmosphere Is Present



**Bemærk:** Oplysningerne i boksene 1 til 7 ændres på basis af kundens ordre.



Dansk



## CLS300 (Digital)

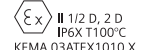

SIEMENS		Digital
<b>POINTEK CLS300</b> 7MLxxxx-xxxx-xxxx [BOX a][BOX 7] Serial No.: GYZ / S1034567 Input: Profibus PA, 12 – 30 V === Amb. Temp.: – 40 °C to 85 °C Encl.: [BOX 1] Cable Entry: [BOX 2] Output: Solid State Relay, 30 V ~, 82 mA		
 N117	 C 159134 US	 FM APPROVED
		
Do Not Open When An Explosive Dust Atmosphere Is Present		



SIEMENS		Digital
<b>POINTEK CLS300</b> 7MLxxxx-xxxx-xxxx [BOX a][BOX 7] Serial No.: GYZ / S1034567 Input: Profibus PA, 12 – 30 V === Amb. Temp.: – 40 °C to 85 °C Encl.: [BOX 1] Cable Entry: [BOX 2] Output: Solid State Relay, 30 V ~, 82 mA		
 C 159134 US		 FM APPROVED
Class II, Div 1, Gr. E, F, G Class III T4		
Do Not Open When An Explosive Dust Atmosphere Is Present		



SIEMENS		Digital
<b>POINTEK CLS300</b> 7MLxxxx-xxxx-xxxx [BOX a][BOX 7] Serial No.: GYZ / S1034567 Input: Profibus PA, 12 – 30 V === Amb. Temp.: – 40 °C to 85 °C Encl.: [BOX 1] Cable Entry: [BOX 2] Output: Solid State Relay, 30 V ~, 82 mA		
		 N117
		
Do Not Open When An Explosive Dust Atmosphere Is Present		



SIEMENS		Digital
<b>POINTEK CLS300</b> 7MLxxxx-xxxx-xxxx [BOX a][BOX 7] Serial No.: GYZ / S1034567 Input: Profibus PA, 12 – 24 V === 12.5 mA Encl.: [BOX 1] Cable Entry: [BOX 2] Output: Solid State Relay, 30 V ~, 82 mA		
 C 159134 US		 FM APPROVED
Class I, Div 1, Gr. A, B, C, D Class II, Div 1, Gr. E, F, G Class III T4 Exia per dwg. A5E01175715		
Refer To Applicable Certificate For Temperature Rating		

SIEMENS		Digital
<b>POINTEK CLS300</b> 7MLxxxx-xxxx-xxxx [BOX a][BOX 7] Serial No.: GYZ / S1034567 Input: Profibus PA, 12 – 24 V === 12.5 mA Encl.: [BOX 1] Cable Entry: [BOX 2] Output: Solid State Relay, 30 V ~, 82 mA		
		 N117
		
Refer To Applicable Certificate For Temp. Rating		

SIEMENS		Digital
<b>POINTEK CLS300</b> 7MLxxxx-xxxx-xxxx [BOX a][BOX 7] Serial No.: GYZ / S1034567 Input: Profibus PA, 12 – 30 V === Amb. Temp.: – 40 °C to 85 °C Encl.: [BOX 1] Cable Entry: [BOX 2] Output: Solid State Relay, 30 V ~, 82 mA		
 C 159134 US		 FM APPROVED
		
Siemens Milltronics Process Instruments Inc.		

SIEMENS		Digital
<b>POINTEK CLS300</b> 7MLxxxx-xxxx-xxxx [BOX a][BOX 7] Serial No.: GYZ / S1034567 Input: Profibus PA, 12 – 30 V === Amb. Temp.: – 40 °C to 85 °C Encl.: [BOX 1] Cable Entry: [BOX 2] Output: Solid State Relay, 30 V ~, 82 mA		
 C 159134 US		 FM APPROVED
Class I, Div 1, Gr. A, B, C, D Class II, Div 1, Gr. E, F, G Class III T4 Seal Conduit < 18 inches		
Use Suitably Rated Cable If Ambient Temp. > 70 °C Do Not Open When An Explosive Atmosphere Is Present		

SIEMENS		Digital
<b>POINTEK CLS300</b> 7MLxxxx-xxxx-xxxx [BOX a][BOX 7] Serial No.: GYZ / S1034567 Input: Profibus PA, 12 – 30 V === Encl.: [BOX 1] Cable Entry: [BOX 2] Output: Solid State Relay, 30 V ~, 82 mA		
 C 159134 US		 FM APPROVED
<b>Segurança</b>  Ex d [ia Ga] IIC T6...T4 Gb Ex tb IIC T85 °C...T100 °C Db DNV 12.0073 X		
ATENÇÃO - NÃO ABRA ONDE UMA ATMOSFERA EXPLOSIVA POSSA ESTAR PRESENTE ATENÇÃO - UTILIZAR CABOS ADEQUADOS PARA TEMPERATURA AMBIENTE > 70 °C Siemens Milltronics Process Instruments, Peterborough		

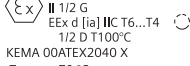
SIEMENS		Digital
<b>POINTEK CLS300</b> 7MLxxxx-xxxx-xxxx [BOX a][BOX 7] Serial No.: GYZ / S1034567 Input: Profibus PA, 12 – 30 V === Encl.: [BOX 1] Cable Entry: [BOX 2] Output: Solid State Relay, 30 V ~, 82 mA		
		 N117
		
Use Suitably Rated Cable If Ambient Temp. > 70 °C Refer To Applicable Certificate For Temp. Rating Do Not Open When An Explosive Atmosphere Is Present		

**Bemærk:** Oplysningerne i boksene 1 til 7 ændres på basis af kundens ordre.