

# Ultrasonic Transducers

XPS/XCT

Operating Instructions · 03/2013



**SIEMENS**



# Echomax XPS/XCT Operation Manual

This manual outlines the essential features and functions of the Echomax XPS/XCT Series transducers. This manual, and the *Transducer Applications Manual*, are also available on our website: [www.siemens.com/processautomation](http://www.siemens.com/processautomation). Printed copies are available from your local Siemens Milltronics representative.

## Questions about the contents of this manual can be directed to:

Siemens Milltronics Process Instruments  
1954 Technology Drive, P.O. Box 4225  
Peterborough, Ontario, Canada, K9J 7B1  
Email: [techpubs.smpi@siemens.com](mailto:techpubs.smpi@siemens.com)

## European Authorized Representative

Siemens AG  
Industry Sector  
76181 Karlsruhe  
Deutschland

### Copyright Siemens Milltronics Process Instruments 2013. All Rights Reserved

### Disclaimer of Liability

We encourage users to purchase authorized bound manuals, or to view electronic versions as designed and authored by Siemens Milltronics Process Instruments. Siemens Milltronics Process Instruments will not be responsible for the contents of partial or whole reproductions of either bound or electronic versions.

While we have verified the contents of this manual for agreement with the instrumentation described, variations remain possible. Thus we cannot guarantee full agreement. The contents of this manual are regularly reviewed and corrections are included in subsequent editions. We welcome all suggestions for improvement.

Technical data subject to change.

MILLTRONICS is a registered trademark of Siemens Milltronics Process Instruments

## Safety Guidelines

Warning notices must be observed to ensure personal safety as well as that of others, and to protect the product and the connected equipment. These warning notices are accompanied by a clarification of the level of caution to be observed.



**WARNING:** relates to a caution symbol on the product, and means that failure to observe the necessary precautions can result in death, serious injury, and/or considerable material damage.



**WARNING:** means that failure to observe the necessary precautions can result in death, serious injury, and/or considerable material damage.

**CAUTION:** means that failure to observe the necessary precautions can result in considerable material damage.

**Note:** means important information about the product or that part of the operating manual.

## Unit Repair and Excluded Liability

- The user is responsible for all changes and repairs made to the device by the user or by the user's agent.
- All new components are to be provided by Siemens Milltronics Process Instruments Inc.
- Restrict repair to faulty components only.
- Do not reuse faulty components.

# Introduction

**This product is intended for use in industrial areas. Operation of this equipment in a residential area may cause interference to several frequency based communications.**

The Echomax XPS/XCT series of transducers operate with Siemens Milltronics ultrasonic level monitoring products.

The transducer converts the electrical transmit pulse from the transceiver into acoustical energy. It then converts the acoustical energy of the echo back into electrical energy for the controller.

The transducer face emits acoustical energy radiating outward, decreasing in amplitude at a rate inversely proportional to the square of the distance. Maximum power radiates perpendicularly from the transducer face on the axis of transmission. Where power is reduced by half (-3 dB), a conical boundary centered around the axis of transmission defines the sound beam, the diameter of which is the beam angle.

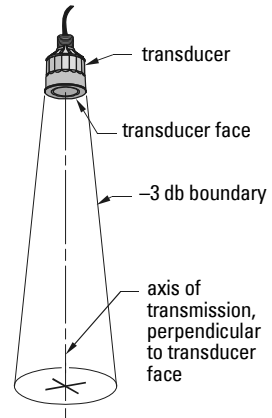

The XPS/XCT transducers have an integrated temperature sensor that reports the air temperature at the transducer to the controller.

## General Guidelines



**WARNING:** Materials of construction are chosen based on their chemical compatibility (or inertness) for general purposes. For exposure to specific environments, check with chemical compatibility charts before installing.

### XPS/XCT Series – Certificate SIRA 99ATEX5153X

This equipment may be used in hazardous areas associated with all gases with temperature classes T1, T2, T3 and T4 for the XPS series (XPS-10, XPS-15, XPS-30, and XPS-40) and T1, T2, and T3 for the XCT series (XCT-8 and XCT-12). The XPS series is only certified for use in ambient temperatures in the range of -40 °C to 95 °C and the XCT series is only certified for use in ambient temperatures in the range of -40 °C to 145 °C. Neither should be used outside of their respective temperature ranges.

Installation shall be carried out in accordance with the applicable code of practice, and by suitably trained personnel.

These devices should only be supplied from a circuit containing a suitably-rated fuse that has a breaking capacity of 4000A. This fuse is included in Siemens Milltronics controllers.

Repair of this equipment shall be carried out in accordance with the applicable code of practice.

The certification of this equipment relies on the following materials used in their construction:

	XPS Series	XCT Series
Enclosure	Kynar® 710	Kynar® 710
Encapsulant	Stycast LA-9823-76	Durapot® 861-F3 & 864

- <sup>1</sup> Kynar® is a registered trademark of ELF Atochem.  
Durapot® is a registered trademark of Cotronics Corporation.

For manual override, use the disconnect switch provided in the building installation of the associated controller.

### XPS 30/40 Series – Certificate SIRA 01ATEX5153X

This equipment may be used in hazardous dust zones with all conductive and non-conductive dusts. The XPS-30 and XPS-40 type series transducers have a maximum surface temperature of 135 °C (275 °F) (Temperature Class T4). These units are certified for use in ambient range of -40 to 95 °C (-40 to 203 °F). The transducers should not be used outside this temperature range. The XPS-30 and XPS-40 ultrasonic transducers must be installed so the face of the transducer is not substantially subjected to light.

Installation shall be carried out in accordance with the applicable code of practice, and by suitably trained personnel. Repair of the equipment shall be carried out in accordance with the applicable code of practice and installation instructions.

These devices should only be supplied from a circuit containing a suitably rated fuse that has a breaking capacity of 4000A. This fuse is included in Siemens Milltronics controllers.

The certification of this equipment relies on the following materials used in their construction:

Enclosure:	Kynar® 710
Encapsulant:	Stycast LA-9823-76



For manual override, use the disconnect switch provided in the building installation of the associated controller.

## Product Marking



**Note:** Kynar® polyvinylidene flouride is resistant to attack from most chemicals under the described operating conditions. However, for exposure to specific environments, check with chemical compatibility charts prior to installation.

**WARNING:** This product is designated as a Pressure Accessory per Directive 97/23/EC and is not intended for use as a safety device.



<b>SIEMENS</b>		  II 2 GD EEx m II T3 SIRA 99ATEX5153X
XCT-8 ULTRASONIC TRANSDUCER Serial No: GYZ / A1034567 Ambient Temp.: -40 °C to 145 °C V in: 1.77 V r.m.s.; 250 Vp I in: 44.2 mA r.m.s.		
Siemens Milltronics Process Instruments, Peterborough		KCC-REM-549 Echomax

ATENÇÃO - RISCO POTENCIAL DE CARGA ELETROSTÁTICA - VEJA INSTRUÇÕES



 Segurança	Class I, Zone 1, Ex s I T4, Amb. Temp.: -40°C to 95°C Ex s IIC T3, Amb. Temp.: -40°C to 145°C DIP IP65 / IP67 ANZEx 08.3066X	 FM APPROVED
	Ex mb IIIC T3 Gb Ex tb IIIC T135 °C Db DNV 12.0077 X	

**WARNING:** Static Hazard,  
Do Not Rub With Dry Cloth.

XCT-12

<b>SIEMENS</b>		 II 2 GD EEx m II T3 SIRA 99ATEX5153X
XCT-12 ULTRASONIC TRANSDUCER Serial No: GYZ / A1034567 Ambient Temp.: -40 °C to 145 °C V in: 1.77 V r.m.s.; 250 Vp I in: 44.2 mA r.m.s.		
Siemens Milltronics Process Instruments, Peterborough		KCC-REM-549 Echomax

ATENÇÃO - RISCO POTENCIAL DE CARGA ELETROSTÁTICA - VEJA INSTRUÇÕES





 FM APPROVED	Class I, Div 2, Group A, B, C, D Class II, Div 2, Group F, G Per Dwg.: 0-9650017Z-DI-A Max. Torque: 15 FT-LBS	 CE 0518	Class I, Zone 1 Ex s I T4, Amb. Temp.: -40° C to 95°C Ex s IIC T3, Amb. Temp.: -40°C to 145°C DIP IP65 / IP67 ANZEx 08.3066X	 KCC-REM-549 Echomax
	ATENÇÃO - RISCO POTENCIAL DE CARGA ELETROSTÁTICA - VEJA INSTRUÇÕES		Ex mb IIIC T3 Gb Ex tb IIIC T135 °C Db DNV 12.0077 X	

**WARNING:** Static Hazard,  
Do Not Rub With Dry Cloth.

**Note:**





- Product configuration number shown for example only.
- Serial number shown for example only.



## XPS-10

SIEMENS	
<b>XPS-10 ULTRASONIC TRANSDUCER</b> Serial No: GYZ / A1034567 Ambient Temp.: - 40 °C to 95 °C V in: 1.77 V r.m.s.; 250 Vp I in : 44.2 mA r.m.s.	 II 2 GD EEx m II T4 SIRA 99ATEX5153X Class I, Zone 1, Ex s IIIC T4 DIP IP65 / 67 ANZEx 08.3066X
Enclosure: IP66, IP68	  0518  KCC-REM-S49 Echomax
Siemens Milltronics Process Instruments, Peterborough	

 FM APPROVED	<b>WARNING:</b> Static Hazard, Do Not Rub With Dry Cloth.	<b>Segurança</b>  INMETRO Ex mb IIC T4 Gb Ex tb IIIC T135 °C Db DNV 12.0077 X
Class I, Div 2, Group A, B, C, D Class II, Div 1, Group E, F, G Per Dwg.: 0-9650017Z-DI-A Max. Torque: 15 FT-LBS	<b>ATENÇÃO - RISCO POTENCIAL DE CARGA ELETROSTÁTICA - VEJA INSTRUÇÕES</b>	

## XPS-15

SIEMENS	
<b>XPS-15 ULTRASONIC TRANSDUCER</b> Serial No: GYZ / A1034567 Ambient Temp.: - 40°C to 95°C V in: 1.77 V r.m.s.; 250 Vp I in : 44.2 mA r.m.s.	 II 2 GD EEx m II T4 SIRA 99ATEX5153X Class I, Zone 1, Ex s IIIC T4 DIP IP65 / 67 ANZEx 08.3066X
Enclosure: IP66, IP68	  0518  KCC-REM-S49 Echomax
Siemens Milltronics Process Instruments, Peterborough	

<b>Segurança</b>  INMETRO Ex mb IIC T4 Gb Ex tb IIIC T135 °C Db DNV 12.0077 X	 FM APPROVED	Class I, Div 2, Group A, B, C, D Class II, Div 1, Group E, F, G Per Dwg.: 0-9650017Z-DI-A Max. Torque: 15 FT-LBS <b>WARNING:</b> Static Hazard, Do Not Rub With Dry Cloth. <b>ATENÇÃO - RISCO POTENCIAL DE CARGA ELETROSTÁTICA - VEJA INSTRUÇÕES</b>
---	---	---



**Note:**

- Product configuration number shown for example only.
- Serial number shown for example only.





## XPS-30

SIEMENS	
<b>XPS-30 ULTRASONIC TRANSDUCER</b> Serial No: GYZ / A1034567 Ambient Temp.: - 40 °C to 95 °C V in: 1.77 V r.m.s.; 250 Vp I in: 44.2 mA r.m.s. Enclosure: IP66, IP68 Siemens Milltronics Process Instruments, Peterborough	   Class I, Zone 1, Ex s IIIC T4 DIP IP65 / 67 ANZEx 08.3066X

Segurança	
 Ex mb IIC T4 Gb Ex tb IIIC T135 °C Db DNV 12.0077 X	 <b>WARNING:</b> Static Hazard, Do Not Rub With Dry Cloth. ATENÇÃO - RISCO POTENCIAL DE CARGA ELETROSTÁTICA - VEJA INSTRUÇÕES

## XPS-40

SIEMENS	
<b>XPS-40 ULTRASONIC TRANSDUCER</b> Serial No: GYZ / A1034567 Ambient Temp.: - 40 °C to 95 °C V in: 1.77 V r.m.s.; 250 Vp I in: 44.2 mA r.m.s. Enclosure: IP66, IP68 Siemens Milltronics Process Instruments, Peterborough	   Class I, Zone 1, Ex s IIIC T4 DIP IP65 / 67 ANZEx 08.3066X

Segurança	
 Ex mb IIC T4 Gb Ex tb IIIC T135 °C Db DNV 12.0077 X	 <b>WARNING:</b> Static Hazard, Do Not Rub With Dry Cloth. ATENÇÃO - RISCO POTENCIAL DE CARGA ELETROSTÁTICA - VEJA INSTRUÇÕES

### Note:

- Product configuration number shown for example only.
- Serial number shown for example only.

# Specifications

	XPS-10	XPS-15	XPS-30	XPS-40	XCT-8	XCT-12
Measurement Range	0.3 - 10 m (1 - 33 ft)	0.3 - 15 m (1 - 50 ft)	0.6 - 30 m (2 - 100 ft)	0.9 - 40 m (3 - 130 ft)	0.6 - 8 m (2 - 26 ft)	0.6 - 12 m (2 - 40 ft)
Frequency (kHz)	44	44	30	22	44	44
Beam Angle	12°	6°	6°	6°	12°	6°
<b>Environmental</b>						
Location	indoor/outdoor	indoor/outdoor	indoor/outdoor	indoor/outdoor	indoor/outdoor	indoor/outdoor
Maximum Altitude (m)	2000	2000	2000	2000	2000	2000
Ambient Temperature	-40 to 95 °C (-40 to 203 °F)	-40 to 95 °C (-40 to 203 °F)	-40 to 95 °C (-40 to 203 °F)	-40 to 95 °C (-40 to 203 °F)	-40 to 145 °C (-40 to 293 °F)	-40 to 145 °C (-40 to 293 °F)
Pressure	8 bar (120 psi)	8 bar (120 psi)	Europe: 0.5 bar N. America: 15 psi	Europe: 0.5 bar N. America: 15 psi	8 bar (120 psi)	8 bar (120 psi)
Pollution Degree	4	4	4	4	4	4
<b>Construction</b>						
Housing	PVDF	PVDF	PVDF	PVDF	<b>Standard:</b> PVDF <b>Optional:</b> Universal* sized flange available with PTFE facing	
Mounting	1" NPT or BSP conduit connection	1" NPT or BSP conduit connection	1-1/2" NPT or BSP conduit connection	1-1/2" NPT or BSP conduit connection	1" NPT or BSP conduit connection	1" NPT or BSP conduit connection
Options	<ul style="list-style-type: none"> <li>factory bonded to suit ANSI, DIN, and JIS standards</li> <li>polyethylene foam facing for dusty or steamy environments</li> <li>submergence shield, where flooding can occur (available only for XPS-10, XPS-15)</li> <li>split flange for field mounting to suit ANSI, DIN, and JIS standards (not available for XPS-40)</li> </ul>					
Cable	2-wire twisted pair/braided and foil shielded, 0.5mm <sup>2</sup> (20 AWG), PVC jacket		<ul style="list-style-type: none"> <li>2-wire twisted pair/braided and foil shielded, 0.5mm<sup>2</sup> (20 AWG), PVC jacket <b>Maximum separation:</b> 100 m (330 ft)</li> <li>RG-62 A/U coax <b>Maximum separation:</b> 365 m (1200 ft)</li> </ul>		Silicon Jacket	
Weight**	0.8 kg (1.7 lb)	1.3 kg (2.8 lb)	4.3 kg (9.5 lb)	8 kg (18 lb)	0.8 kg (1.7 lb)	1.3 kg (2.8 lb)
Maximum Separation	365 m (1200 ft)	365 m (1200 ft)	365 m (1200 ft)	365 m (1200 ft)	365 m (1200 ft)	365 m (1200 ft)
Supply Source	Transducers shall only be supplied by Siemens Milltronics certified controllers					
Approvals	CE***, CSA, FM, CENELEC/ATEX, INMETRO: See nameplate or consult Siemens Milltronics for current approvals.					

\* Universal flange fits ANSI, DIN, and JIS standards.

\*\* Approximate shipping weight of transducer with standard cable length.

\*\*\* EMC performance available upon request.

# Outline and Dimensions

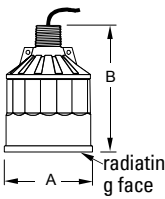

standard

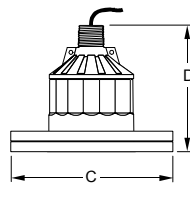

optional bonded flange  
refer to associated instructions

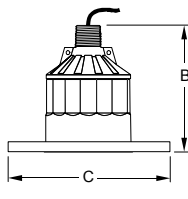

optional split flange  
refer to associated instructions

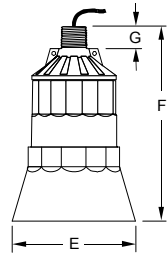

optional submergence shield  
refer to associated instructions

Dimension	XPS-10	XPS-15	XPS-30	XPS-40	XCT-8	XCT-12
A	88 mm (3.4")	121 mm (4.8")	175 mm (6.9")	206 mm (8.1")	88 mm (3.4")	121 mm (4.8")
B	122 mm (4.8")	132 mm (5.2")	198 mm (7.8")	229 mm (9.0")	122 mm (4.8")	132 mm (5.2")
C	to suit ANSI, DIN and JIS standards					
D*	128 mm (5.0")	138 mm (5.4")	204 mm (8.0")	235 mm (9.2")	128 mm (5.0")	138 mm (5.4")
E	124 mm (4.9")	158 mm (6.2")	n / a	n / a	n / a	n / a
F	152 mm (6.0")	198 mm (7.8")	n / a	n / a	n / a	n / a
G	28 mm (1.1")	28 mm (1.1")	28 mm (1.1")	28 mm (1.1")	28 mm (1.1")	28 mm (1.1")

\* nominal



**WARNING:** Optional Split Flange, Bonded Flange, and Easy Aimer configurations are not suitable for pressure applications.

# Mounting



**WARNING:** Special handling precautions must be taken to protect the face of the transducer from any damage.

- Mount the transducer so that it is **above the maximum material level by at least the blanking value**. Refer to the associated controller manual.
- On liquid applications, mount the transducer face parallel to the liquid surface. On solids applications, use a Siemens Milltronics Easy Aimer to help aim the transducer.
- Do not overtighten. Most applications require only hand tightening of the mounting hardware. Connect a safety chain from the transducer to a structural member to secure installation. Consider using the optional **temperature sensor** when a flanged transducer is used, when a fast temperature response is required, or in high temperature vessels.

**Note:** For pressure tight applications, install transducers hand tight plus ½ turn to 1½ turns. PTFE tape or other appropriate sealant may be used to aid in sealing the threads for use in pressure applications.

## Mounting – Solids Applications

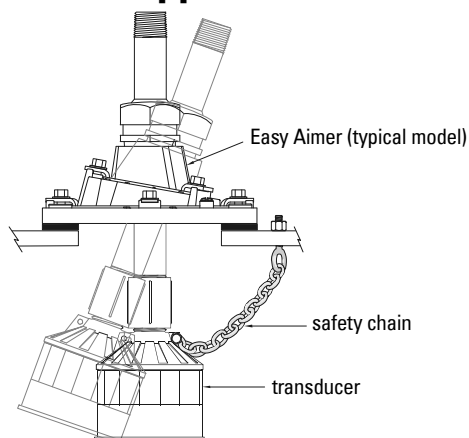

**WARNING:** Improper installation may result in loss of process pressure.

# Mounting – Liquid Applications

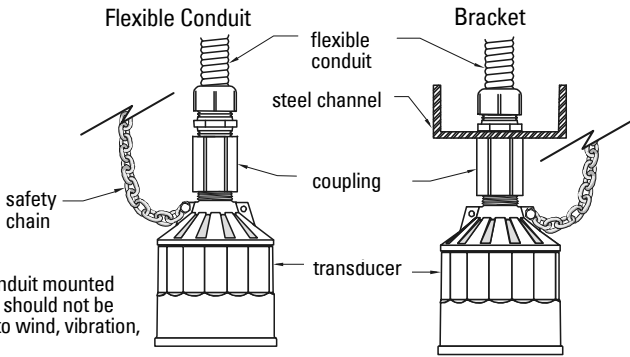

Flexible conduit mounted transducer should not be subjected to wind, vibration, or jarring.

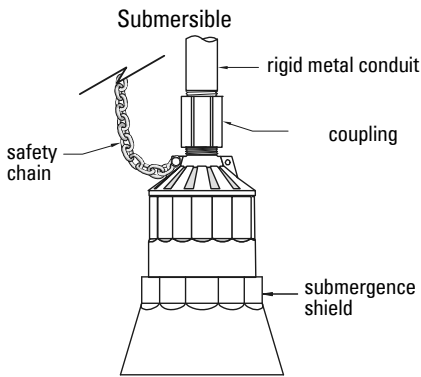

Transducer with submergence shield, used in applications where flooding is possible.

## Plywood

Plywood mounting provides excellent isolation, but must be rigid enough to avoid flexing if subjected to loading.

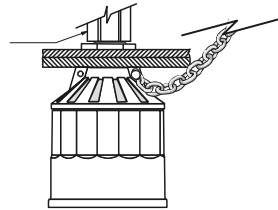

## Mounting – Liquid Applications (cont'd)

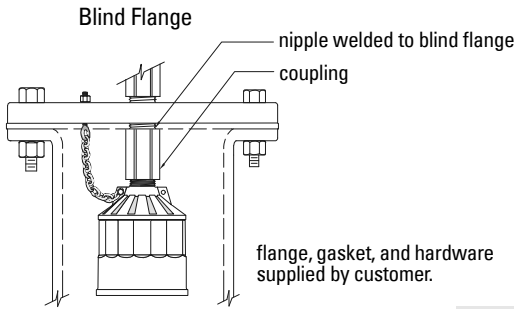

**Note:** Tighten the flange bolts evenly in order to ensure a good seal between the mating flanges.

**Caution: Overtightening can cause performance degradation.**

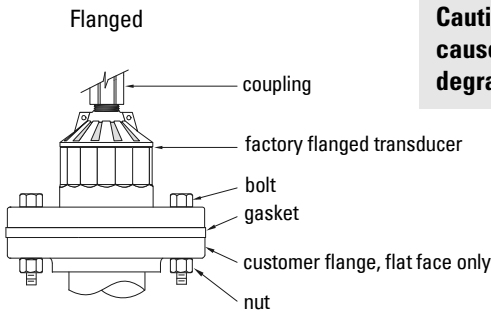

Customer flanged standpipe. If a metal flange must be welded to pipe, refer to Liquid Applications - Standpipes in the *Transducer Applications Manual*.

## Installation

**Note:** Installation shall only be performed by qualified personnel and in accordance with local governing regulations.

- Do not route cable openly. For optimum isolation against electrical noise, run cable separately in a grounded metal conduit. Seal all thread connections to prevent ingress of moisture.
- Do not run cable near high voltage or current runs, contactors, and SCR control drives. For pressure tight applications, install transducers hand tight plus  $\frac{1}{2}$  to  $1\frac{1}{2}$  turns.
- PTFE tape or other appropriate sealant may be used to aid in sealing the threads for use in pressure applications.



**WARNING:** Never attempt to loosen, remove, or disassemble process connection while vessel contents are under pressure.

# Interconnection

## Direct Connection

Connect the transducer directly to the Siemens Milltronics transceiver via the two conductor shielded cable.

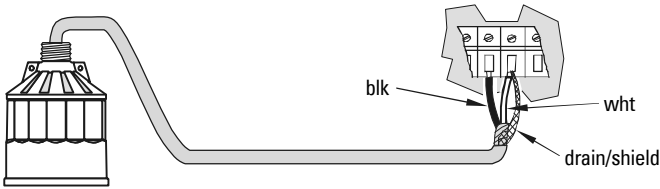

**Note:** When connecting to a SITRANS LUT400, a SITRANS LUC500, a MultiRanger 100/200, or a HydroRanger 200, the white, black, and shield wires are all connected separately. DO NOT tie the white and shield wires together.

## Coaxial Connection

Connect the transducer to the Siemens Milltronics transceiver via a junction box and RG-62 A/U coaxial cable. This setup is effective for combined runs up to 365 m (1200 ft).

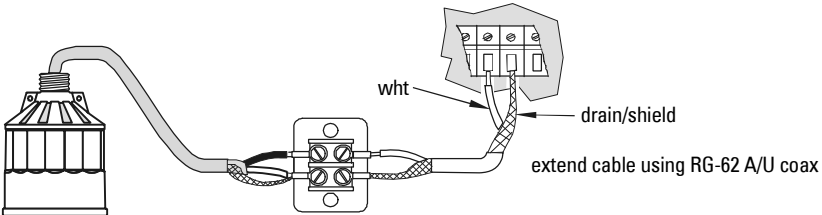

**Note:** When connecting to a SITRANS LUT400, a SITRANS LUC500, a MultiRanger 100/200, or a HydroRanger 200, do NOT use coaxial cable; see diagram below for proper procedure.

## 2-Wire Extension

(for SITRANS LUT400, SITRANS LUC500, MultiRanger 100/200, and HydroRanger 200 only)

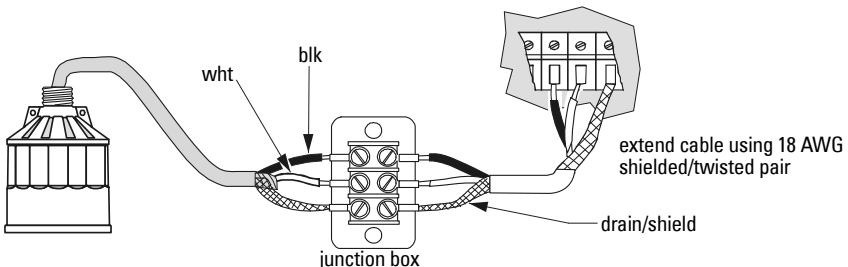





# Echomax XPS/XCT Driftsvejledning

Denne manual opřidser de væsentligste karakteristika og funktioner af transducerne i serien Echomax XPS/XCT. Denne manual samt *Vejledning i anvendelse af transducere* kan også findes på vort website: [www.siemens.com/processautomation](http://www.siemens.com/processautomation). Trykte eksemplarer kan fås hos din lokale Siemens Milltronics repræsentant.

## Spørgsmål vedrørende indholdet af denne manual kan rettes til:

Siemens Milltronics Process Instruments  
1954 Technology Drive, P.O. Box 4225  
Peterborough, Ontario, Canada, K9J 7B1  
Email: [techpubs.smpi@siemens.com](mailto:techpubs.smpi@siemens.com)

## Europæisk autoriseret repræsentant

Siemens AG  
Industry Sector  
76181 Karlsruhe  
Deutschland

Dansk

**Copyright Siemens Milltronics  
Process Instruments 2013.  
Alle rettigheder forbeholdes**

## Ansvarsfragåelse

Vi opfordrer brugerne til at anskaffe de autoriserede, indbundne manualer eller at læse de elektroniske versioner, der er udarbejdet og skrevet af Siemens Milltronics Process Instruments. Siemens Milltronics Process Instruments påtager sig intet ansvar for indholdet af delvise eller fuldstændige gengivelser af indbundne eller elektroniske versioner.

Skønt vi har kontrolleret, at indholdet af denne manual stemmer overens med de beskrevne instrumenter, kan der stadig forekomme variationer. Vi kan derfor ikke garantere en fuldstændig overensstemmelse. Indholdet af denne manual revideres jævnligt, og eventuelle rettelser inkluderes i de efterfølgende udgaver. Vi modtager gerne forslag til forbedringer. Retten til ændringer af de tekniske data forbeholdes.

MILLTRONICS er et registreret varemærke, der tilhører Siemens Milltronics Process Instruments

## Sikkerhedsvejledning

De anførte advarsler skal overholdes for at sikre egen og andres sikkerhed samt for at beskytte produktet og det tilhørende udstyr. Disse advarsler ledsages af en tydeliggørelse af graden af forsigtighed, der bør overholdes.



**ADVARSEL:** vedrører et advarselssymbol på produktet og betyder, at en manglende overholdelse af de nødvendige forholdsregler kan føre til død, alvorlig personskade og/eller omfattende materielle skader.



**ADVARSEL:** betyder, at en manglende overholdelse af de nødvendige forholdsregler kan føre til død, alvorlig personskade og/eller omfattende materielle skader.

**PAS PÅ:** betyder, at en manglende overholdelse af de nødvendige forholdsregler kan føre til omfattende materielle skader.

**Bemærk:** betyder vigtige oplysninger om produktet eller denne del af brugsvejledningen.

## Reparation af instrumentet og ansvarsbegrænsning

- Brugeren er ansvarlig for alle modifikationer og reparationer, der udføres på apparatet af brugeren eller dennes repræsentant.
- Alle nye dele skal leveres af Siemens Milltronics Process Instruments Inc.
- Kun defekte dele bør repareres.
- Defekte dele må ikke genbruges.

# Indledning

**Dette produkt er beregnet til anvendelse i industriområder. Brugen af dette udstyr i et beboelsesområde kan forårsage interferens med forskellige frekvensbaserede kommunikationer.**

Transducerne i serien Echomax XPS/XCT fungerer med Siemens Milltronics ultralydsniveauovervågningsprodukter.

Transduceren omdanner den elektriske sendeimpuls fra transceiveren til akustisk energi. Derefter omdanner den ekkoets akustiske energi tilbage til elektrisk energi til kontrolenheden.

Transduceroverfladen udsender akustisk energi, der udbreder sig med en amplitude, der falder omvendt proportionalt til kvadraten af afstanden. Den udbredte effekt er maksimal vinkelret på transduceroverfladen langs transmissionsaksen. Lydstrålen, hvis diameter betegnes strålevinklen, defineres som en kegle centreret omkring transmissionsaksen, med en grænse svarende til en reduktion af effekten til halvdelen (-3 dB).

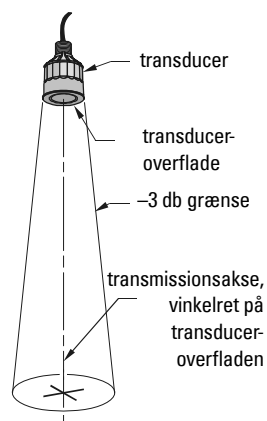

XPS/XCT transducerne har en indbygget temperaturføler, der angiver lufttemperaturen til kontrolenheden.

## Generel vejledning



**ADVARSEL:** Konstruktionsmaterialerne er valgt på basis af deres kemiske kompatibilitet (eller inert) ved almindelig brug. Hvis de skal udsættes for særlige omgivelser, bør foreneligheden kontrolleres i tabeller over kemiske kompatibiliteter inden installationen.

### XPS/XCT Serien – Certifikat SIRA 99ATEX5153X

Dette udstyr kan anvendes i eksplosionsfarlige områder i forbindelse med alle gasser med temperaturklasserne T1, T2, T3 og T4 for XPS serien (XPS-10, XPS-15, XPS-30 og XPS-40) og klasserne T1, T2 og T3 for XCT serien (XCT-8 og XCT-12). XPS serien er kun godkendt til brug ved omgivende temperaturer i intervallet fra -40 °C til 95 °C, og XCT serien er kun godkendt til brug ved omgivende temperaturer i intervallet fra -40 °C til 145 °C. Disse apparater bør ikke anvendes uden for deres respektive temperaturinterval.

Installationen af dette udstyr skal udføres af tilstrækkeligt uddannet personale i henhold til de gældende normer.

Disse apparater bør kun strømforsynes fra et kredsløb, der omfatter en sikring af passende intensitet, der har en brydeevne på 4.000A. Denne sikring er inkluderet i Siemens Milltronics' kontrolenheder.

Reparation af dette udstyr skal udføres i henhold til de gældende normer.

Dette udstyr er godkendt på baggrund af brugen af følgende materialer ved dets fremstilling:

	XPS serien	XCT serien
Hus	Kynar® 710	Kynar® 710
Indkapsling	Stycast LA-9823-76	Durapot® 861-F3 og 864

1. Kynar® er et registreret varemærke, der tilhører ELF Atochem.  
Durapot® er et registreret varemærke, der tilhører Cotronics Corporation.

For en manuel omgåelse bruges den afbryder, der indgår i installationen af den tilhørende kontrolenhed i bygningen.

### XPS 30/40 serien – Certifikat SIRA 01ATEX5153X

Dette udstyr kan anvendes i eksplosionsfarlige, støvende områder med alle typer ledende eller ikke-ledende støv. Transducerne i serierne af typen XPS-30 og XPS-40 har en maksimal overfladetemperatur på 135 °C (275 °F) (Temperaturklasse T4). Disse enheder er godkendt til brug i et interval af omgivende temperaturer på fra -40 til 95 °C (-40 til 203 °F). Transducerne bør ikke anvendes uden for dette temperaturinterval. Ultralydstransducerne XPS-30 og XPS-40 skal installeres, således at transduceroverfladen ikke udsættes for lys i væsentligt omfang.

Installationen skal udføres af tilstrækkeligt uddannet personale i henhold til de gældende normer. Reparation af dette udstyr skal udføres i henhold til de gældende normer og installationsvejledninger.

Disse apparater bør kun strømforsynes fra et kredsløb, der omfatter en sikring af passende intensitet, der har en brydeevne på 4.000A. Denne sikring er inkluderet i Siemens Milltronics' kontrolenheder.

Dette udstyr er godkendt på baggrund af brugen af følgende materialer ved dets fremstilling:

Hus:	Kynar® 710
Indkapsling:	Stycast LA-9823-76

For en manuel omgåelse bruges den afbryder, der indgår i installationen af den tilhørende kontrolenhed i bygningen.

### Produktets mærkning



**Bemærk:** Kynar® polyvinylidenfluorid er modstandsdygtigt over for angreb fra de fleste kemikalier ved de beskrevne driftsbetingelser. Hvis det skal udsættes for særlige omgivelser, bør foreneligheden dog kontrolleres i tabeller over kemiske kompatibiliteter inden installationen.

**ADVARSEL:** Dette produkt betegnes som trykbærende udstyr i henhold til direktivet 97/23/ EF og er **ikke** beregnet til brug som sikkerhedsanordning.





## XCT-8

SIEMENS	
XCT-8 ULTRASONIC TRANSDUCER Serial No: GYZ / A1034567 Ambient Temp.: -40 °C to 145 °C V in: 1.77 V r.m.s.; 250 Vp I in: 44.2 mA r.m.s.	CE 0518 II 2 GD EEx m II T3 SIRA 99ATEX5153X KCC-REM-549 Echomax
Enclosure: IP66, IP68	ATENÇÃO - RISCO POTENCIAL DE CARGA ELETROSTÁTICA - VEJA INSTRUÇÕES
Siemens Milltronics Process Instruments, Peterborough	

Segurança	
 Ex mb IIIC T3 Gb Ex tb IIIC T135 °C Db DNV 12.0077 X	Class I, Zone 1, Ex s I T4, Amb. Temp.: -40°C to 95°C Ex s IIC T3, Amb. Temp.: -40°C to 145°C DIP IP65 / IP67 ANZEx 08.3066X <b>WARNING:</b> Static Hazard, Do Not Rub With Dry Cloth.
	 APPROVED Class I, Div 2, Group A, B, C, D Class II, Div 2, Group F, G Per Dwg.: 0-9650017Z-DI-A Max. Torque: 15 FT-LBS

## XCT-12

SIEMENS	
XCT-12 ULTRASONIC TRANSDUCER Serial No: GYZ / A1034567 Ambient Temp.: -40 °C to 145 °C V in: 1.77 V r.m.s.; 250 Vp I in: 44.2 mA r.m.s.	CE 0518 II 2 GD EEx m II T3 SIRA 99ATEX5153X KCC-REM-549 Echomax
Enclosure: IP66, IP68	ATENÇÃO - RISCO POTENCIAL DE CARGA ELETROSTÁTICA - VEJA INSTRUÇÕES
Siemens Milltronics Process Instruments, Peterborough	

Segurança	
 Ex mb IIIC T3 Gb Ex tb IIIC T135 °C Db DNV 12.0077 X	Class I, Zone 1 Ex s I T4, Amb. Temp.: -40°C to 95°C Ex s IIC T3, Amb. Temp.: -40°C to 145°C DIP IP65 / IP67 ANZEx 08.3066X <b>WARNING:</b> Static Hazard, Do Not Rub With Dry Cloth.
	 APPROVED Class I, Div 2, Group A, B, C, D Class II, Div 2, Group F, G Per Dwg.: 0-9650017Z-DI-A Max. Torque: 15 FT-LBS
ATENÇÃO - RISCO POTENCIAL DE CARGA ELETROSTÁTICA - VEJA INSTRUÇÕES	

### Bemærk:

- Den viste produktkonfiguration er kun givet som eksempel.
- Det viste serienummer er kun givet som eksempel.

## XPS-10

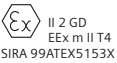
SIEMENS			
<b>XPS-10 ULTRASONIC TRANSDUCER</b> Serial No: GYZ / A1034567 Ambient Temp.: - 40 °C to 95 °C V in : 1.77 V r.m.s.; 250 Vp I in : 44.2 mA r.m.s.		 II 2 GD EEx m II T4 SIRA 99ATEX5153X	
Enclosure: IP66, IP68 Siemens Milltronics Process Instruments, Peterborough		Class I, Zone 1, Ex s IIICT4 DIP IP65 / 67 ANZEx 08.3066X	

 Class I, Div 2, Group A, B, C, D Class II, Div 1, Group E, F, G Per Dwg.: 0-9650017Z-DI-A Max. Torque: 15 FT-LBS	<b>WARNING:</b> Static Hazard, Do Not Rub With Dry Cloth.	<b>Segurança</b>  Ex mb IIC T4 Gb Ex tb IIIC T135 °C Db DNV 12.0077 X
<b>ATENÇÃO - RISCO POTENCIAL DE CARGA ELETROSTÁTICA - VEJA INSTRUÇÕES</b>		

## XPS-15

SIEMENS			
<b>XPS-15 ULTRASONIC TRANSDUCER</b> Serial No: GYZ / A1034567 Ambient Temp.: - 40°C to 95°C V in : 1.77 V r.m.s.; 250 Vp I in : 44.2 mA r.m.s.		 KCC-REM-S49 Echomax	
Enclosure: IP66, IP68 Siemens Milltronics Process Instruments, Peterborough		 0518  II 2 GD EEx m II T4 SIRA 99ATEX5153X	
		Class I, Zone 1, Ex s IIICT4 DIP IP65 / 67 ANZEx 08.3066X	



<b>Segurança</b>  Ex mb IIC T4 Gb Ex tb IIIC T135 °C Db DNV 12.0077 X	 Class I, Div 2, Group A, B, C, D Class II, Div 1, Group E, F, G Per Dwg.: 0-9650017Z-DI-A Max. Torque: 15 FT-LBS	<b>WARNING:</b> Static Hazard, Do Not Rub With Dry Cloth. <b>ATENÇÃO - RISCO POTENCIAL DE CARGA ELETROSTÁTICA - VEJA INSTRUÇÕES</b>
--	--	--

### Bemærk:

- Den viste produktkonfiguration er kun givet som eksempel.
- Det viste serienummer er kun givet som eksempel.



## XPS-30

SIEMENS	
<b>XPS-30 ULTRASONIC TRANSDUCER</b> Serial No: GYZ / A1034567 Ambient Temp.: - 40 °C to 95 °C V in: 1.77 V r.m.s.; 250 Vp I in: 44.2 mA r.m.s. Enclosure: IP66, IP68 Siemens Milltronics Process Instruments, Peterborough	   Class I, Zone 1, Ex s IIIC T4 DIP IP65 / 67 ANZEx 08.3066X

Segurança	
 Ex mb IIC T4 Gb Ex tb IIIC T135 °C Db DNV 12.0077 X	 Class I, Div 2, Group A, B, C, D Class II, Div 1, Group E, F, G Per Dwg.: 0-9650017Z-DI-A Max. Torque: 15 FT-LBS (20 N-m) <b>WARNING:</b> Static Hazard, Do Not Rub With Dry Cloth. <b>ATENÇÃO - RISCO POTENCIAL DE CARGA ELETROSTÁTICA - VEJA INSTRUÇÕES</b>

## XPS-40

SIEMENS	
<b>XPS-40 ULTRASONIC TRANSDUCER</b> Serial No: GYZ / A1034567 Ambient Temp.: - 40 °C to 95 °C V in: 1.77 V r.m.s.; 250 Vp I in: 44.2 mA r.m.s. Enclosure: IP66, IP68 Siemens Milltronics Process Instruments, Peterborough	   Class I, Zone 1, Ex s IIIC T4 DIP IP65 / 67 ANZEx 08.3066X

Segurança	
 Ex mb IIC T4 Gb Ex tb IIIC T135 °C Db DNV 12.0077 X	 Class I, Div 2, Group A, B, C, D Class II, Div 1, Group E, F, G Per Dwg.: 0-9650017Z-DI-A Max. Torque: 15 FT-LBS (20 N-m) <b>WARNING:</b> Static Hazard, Do Not Rub With Dry Cloth. <b>ATENÇÃO - RISCO POTENCIAL DE CARGA ELETROSTÁTICA - VEJA INSTRUÇÕES</b>

### Bemærk:

- Den viste produktkonfiguration er kun givet som eksempel.
- Det viste serienummer er kun givet som eksempel.

# Tekniske data

	XPS-10	XPS-15	XPS-30	XPS-40	XCT-8	XCT-12
<b>Måleområde</b>	0,3 - 10 m (1 - 33 fod)	0,3 - 15 m (1 - 50 fod)	0,6 - 30 m (2 - 100 fod)	0,9 - 40 m (3 - 130 fod)	0,6 - 8 m (2 - 26 fod)	0,6 - 12 m (2 - 40 fod)
<b>Frekvens (kHz)</b>	44	44	30	22	44	44
<b>Strålevinkel</b>	12°	6°	6°	6°	12°	6°
<b>Omgivelser</b>						
<b>Placering</b>	indendørs/ udendørs	indendørs/ udendørs	indendørs/ udendørs	indendørs/ udendørs	indendørs/ udendørs	indendørs/ udendørs
<b>Maksimal højde (m)</b>	2000	2000	2000	2000	2000	2000
<b>Omgivende temperatur</b>	-40 til 95 °C (-40 til 203 °F)	-40 til 95 °C (-40 til 203 °F)	-40 til 95 °C (-40 til 203 °F)	-40 til 95 °C (-40 til 203 °F)	-40 til 145 °C (-40 til 293 °F)	-40 til 145 °C (-40 til 293 °F)
<b>Tryk</b>	8 bar (120 psi)	8 bar (120 psi)	Europa: 0,5 bar N. Amerika: 15 psi	Europa: 0,5 bar N. Amerika: 15 psi	8 bar (120 psi)	8 bar (120 psi)
<b>Forureningsgrad</b>	4	4	4	4	4	4
<b>Konstruktion</b>						
<b>Hus</b>	PVDF	PVDF	PVDF	PVDF	<b>Standard:</b> PVDF <b>Ekstraudstyr:</b> Universel* størrelse flange med PTFE- overflade	
<b>Montage</b>	1" NPT eller BSP kabelrør- tilslutning	1" NPT eller BSP kabelrør- tilslutning	1-1/2" NPT eller BSP kabelrør- tilslutning	1-1/2" NPT eller BSP kabelrør- tilslutning	1" NPT eller BSP kabelrør- tilslutning	1" NPT eller BSP kabelrør- tilslutning
<b>Valgmuligheder</b>	<ul style="list-style-type: none"> <li>fabrikssamlet iht. ANSI, DIN og JIS standarderne</li> <li>overflade af polyethylenskum til omgivelser m. støv el. damp</li> <li>neddykningsbeskyttelse til steder m. risiko for oversvømmelse (fås kun til XPS-10, XPS-15)</li> <li>delt flange til feltmontering iht. ANSI, DIN og JIS standarderne (fås ikke til XPS-40)</li> </ul>					
<b>Kabel</b>	2-tråds parsnoet/flettet og folieafskærmet, 0,5mm <sup>2</sup> (20 AWG), kappe af PVC		• 2-tråds parsnoet/flettet og folieafskærmet, 0,5mm <sup>2</sup> (20 AWG), kappe af PVC <b>Maksimal afstand:</b> 100 m (330 fod)		Kappe af silicone	
<b>Vægt**</b>	0,8 kg (1,7 lb)	1,3 kg (2,8 lb)	4,3 kg (9,5 lb)	8 kg (18 lb)	0,8 kg (1,7 lb)	1,3 kg (2,8 lb)
<b>Maksimal afstand</b>	365 m (1200 fod)	365 m (1200 fod)	365 m (1200 fod)	365 m (1200 fod)	365 m (1200 fod)	365 m (1200 fod)
<b>Forsyningskilde</b>	Transducerne må kun forsynes fra kontrolenheder, der er godkendt af Siemens Milltronics					
<b>Godkendelser</b>	CE***, CSA, FM, CENELEC/ATEX, INMETRO: Se på navneskiltet eller jf. Siemens Milltronics for de aktuelle godkendelser.					

\* Universel flange, der passer til ANSI, DIN og JIS standarderne.

\*\* Omtrentlig forsendelsesvægt af transducer med standard kabellængde.

\*\*\* EMC-data fås på anfordring.



# Omrids og dimensioner

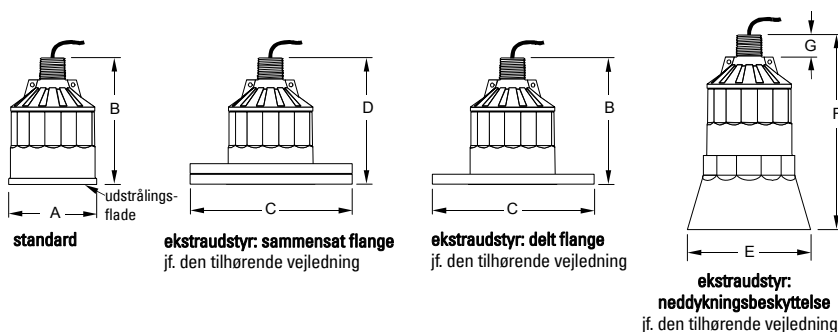

Dimensioner	XPS 10	XPS-15	XPS-30	XPS-40	XCT-8	XCT-12
A	88 mm (3,4")	121 mm (4,8")	175 mm (6,9")	206 mm (8,1")	88 mm (3,4")	121 mm (4,8")
B	122 mm (4,8")	132 mm (5,2")	198 mm (7,8")	229 mm (9,0")	122 mm (4,8")	132 mm (5,2")
C	passende til ANSI, DIN og JIS standarderne					
D*	128 mm (5,0")	138 mm (5,4")	204 mm (8,0")	235 mm (9,2")	128 mm (5,0")	138 mm (5,4")
E	124 mm (4,9")	158 mm (6,2")	ikke relevant	ikke relevant	ikke relevant	ikke relevant
F	152 mm (6,0")	198 mm (7,8")	ikke relevant	ikke relevant	ikke relevant	ikke relevant
G	28 mm (1,1")	28 mm (1,1")	28 mm (1,1")	28 mm (1,1")	28 mm (1,1")	28 mm (1,1")

\* nominal



**ADVARSEL:** Konfigurationerne m. Delt flange, Sammensat flange eller Easy Aimer (ekstraudstyr) er **ikke** egnet til anvendelser under tryk.

## Montage

**ADVARSEL:** Ved håndteringen skal der træffes særlige forholdsregler for at beskytte transducerens overflade mod beskadigelse.

- Transducere monteres, så den sidder i en afstand **over materialets maksimale niveau, der mindst er lig med slukningsafstanden**. Der henvises til manualen for den tilhørende kontrolenhed.
- Ved anvendelser med væsker monteres transducerfladen parallelt med væskeoverfladen. Ved anvendelser med faste stoffer bruges en Siemens Milltronics Easy Aimer som hjælp til at rette transduceren ind.
- Pas på ikke at stramme for meget. Ved de fleste anvendelser er det tilstrækkeligt at stramme udstyret med håndkraft. Forbind transduceren til et strukturelement med en sikkerhedskæde for at sikre installationen. Overvej at bruge en **temperaturføler** (ekstraudstyr), når der anvendes en transducer med flange, såfremt der kræves en hurtig respons på temperaturen, eller i beholdere ved høj temperatur.

**Bemærk:** Ved tryktætte anvendelser installeres transducerne med en stramning ved håndkraft plus ½ til 1½ ekstra omgang. PTFE-tape eller et andet passende tætningsmiddel kan bruges til at tætnes gevindene ved brug i trykanvendelser.

# Montage – Anvendelser med faste stoffer

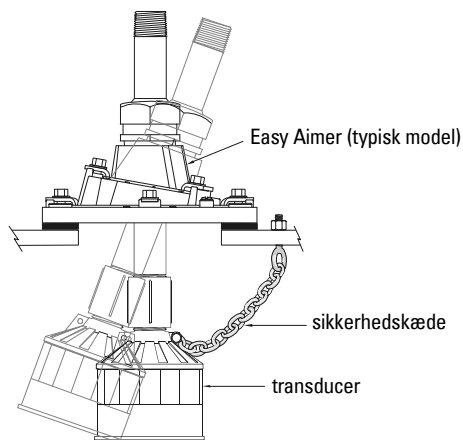

**ADVARSEL:** Ukorrekt installation kan medføre tab af procestryk.

# Montage – Anvendelser med væsker

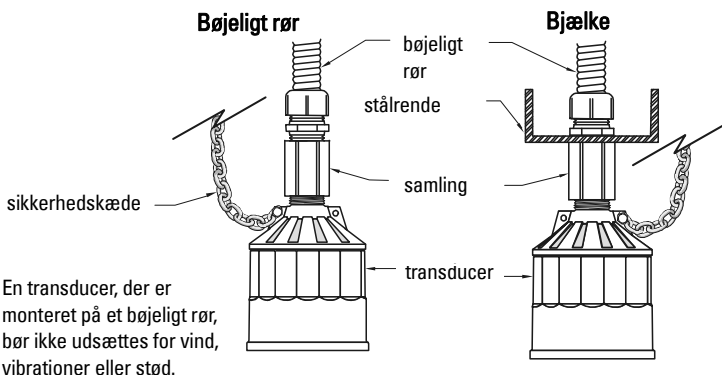

En transducer, der er monteret på et bøjeligt rør, bør ikke udsættes for vind, vibrationer eller stød.

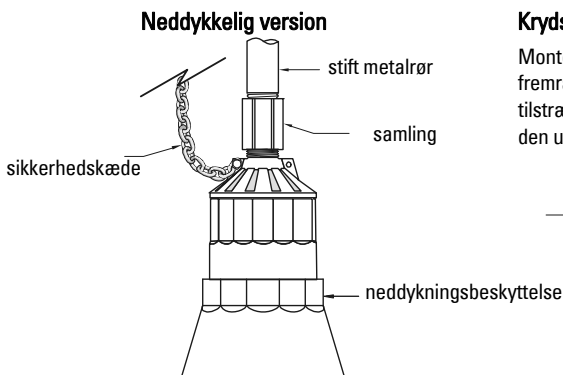

## Krydsfiner

Montering på krydsfiner giver en fremragende isolation men bør være tilstrækkelig stiv til ikke at bøjes, hvis den udsættes for belastning.

Transducer med neddykningsbeskyttelse, der bruges i anvendelser, hvor der er risiko for oversvømmelse.

# Montage – Anvendelser med væsker (fortsat)

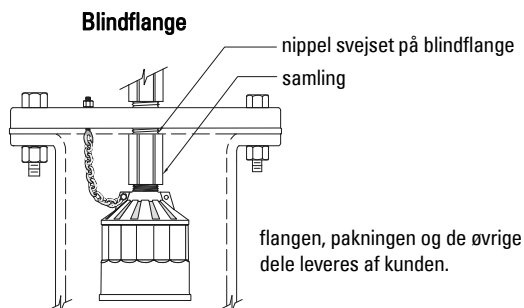

## Med flange

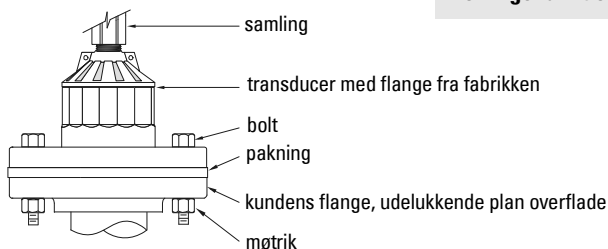

Stigrør med flange hos kunden. Hvis der skal svejdes en metallisk flange på røret, henvises der til Anvendelser med væsker – Stigrør i *Vejledning i anvendelse af transducere*.

**Bemærk:** Stram flangens bolte jævnt for at sikre en god tætning mellem modflangerne.  
**Pas på:** Overdreven stramning kan forringe funktionsegenskaberne.

# Installation

---

**Bemærk:** Installationen må kun foretages af kvalificeret personale og under overholdelse af de lokalt gældende regler.

- Undgå at trække kablet utildækket. For en optimal isolation mod elektrisk støj bør kablet føres separat i et jordet metalrør. Tætn alle gevindsamlinger for at undgå fugtindtrængning.
- Undgå at føre kablet i nærheden af højspænding eller stærkstrøm, kontaktorer eller SCR-styredrev. Ved tryktætte anvendelser installeres transducerne med stramning ved håndkraft plus  $\frac{1}{2}$  til  $1\frac{1}{2}$  ekstra omgang.
- PTFE-tape eller et andet passende tætningsmiddel kan bruges til at tætn gevindene ved brug i trykanvendelser.



**ADVARSEL:** Forsøg aldrig at løsne, afmontere eller adskille procestilslutningen, mens indholdet er under tryk.

# Sammenkobling

## Direkte forbindelse

Forbind transduceren direkte til Siemens Milltronics transceiveren via det afskærmede to-leder-kabel.

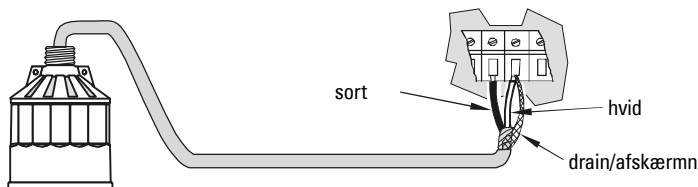

**Bemærk:** Ved tilslutning til en SITRANS LUT400, en SITRANS LUC500, en MultiRanger 100/200 eller en HydroRanger 200 forbindes den hvide ledning, den sorte ledning og afskærmningsledningen alle separat. Den hvide ledning og afskærmningsledningen MÅ IKKE forbindes med hinanden.

## Koaksial forbindelse

Forbind transduceren til Siemens Milltronics transceiveren via en tilslutningsdåse og RG-62 A/U koaksialkabel. Dette arrangement er effektivt for en samlet afstand på op til 365 m (1200 fod).

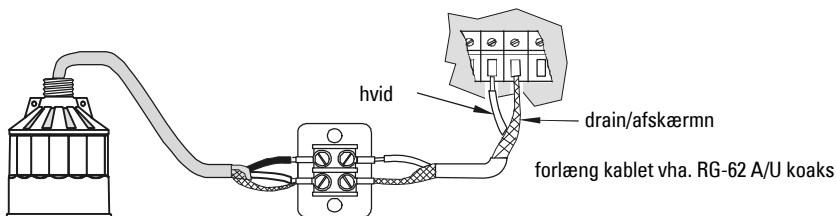

**Bemærk:** Ved tilslutning til en SITRANS LUT400, en SITRANS LUC500, MultiRanger 100/200 og HydroRanger 200 må koaksialkabel IKKE BRUGES; jf. den egnede procedure i nedenstående diagram.

## 2-Leder-forlængelse

(kun for SITRANS LUT400, SITRANS LUC500, , MultiRanger 100/200 og HydroRanger 200)

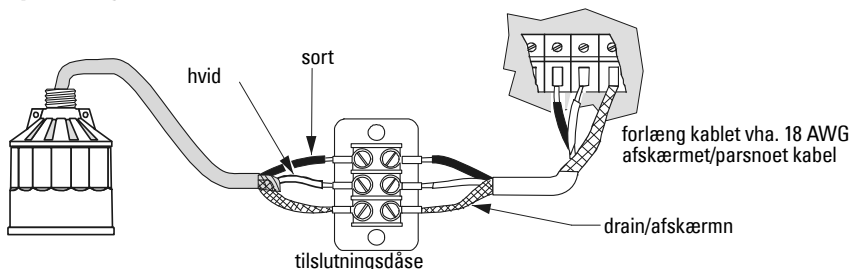



# Echomax XPS/XCT Betriebsanleitung

Diese Betriebsanleitung ist eine Kurzfassung der wesentlichen Merkmale und Funktionen der Ultraschallsensoren Baureihe Echomax XPS/XCT. Diese Anleitung und das *Applikationshandbuch Ultraschallsensoren* sind auch auf unserer Webseite verfügbar: [www.siemens.com/processautomation](http://www.siemens.com/processautomation). Gebundene Exemplare können Sie von Ihrer örtlichen Siemens Milltronics Vertretung erhalten.

## Wenn Sie Fragen haben, wenden Sie sich bitte an:

Siemens Milltronics Process Instruments  
1954 Technology Drive, P.O. Box 4225  
Peterborough, Ontario, Canada, K9J 7B1  
Email: [techpubs.smpi@siemens.com](mailto:techpubs.smpi@siemens.com)

## EU-Bevollmächtigter

Siemens AG  
Industry Sector  
76181 Karlsruhe  
Deutschland

### Copyright Siemens Milltronics Process Instruments 2013. All Rights Reserved

Diese Unterlage ist sowohl in gebundener als auch in elektronischer Form verfügbar. Wir fordern Benutzer auf, genehmigte, gebundene Betriebsanleitungen zu erwerben oder die von Siemens Milltronics Process Instruments entworfenen und genehmigten elektronischen Ausführungen zu betrachten. Siemens Milltronics Process Instruments ist für den Inhalt auszugsweiser oder vollständiger Wiedergaben gebundener oder elektronischer Ausführungen nicht verantwortlich.

### Haftungsausschluss

Wir haben den Inhalt der Druckschrift auf Übereinstimmung mit dem beschriebenen Gerät geprüft. Dennoch können Abweichungen nicht ausgeschlossen werden, so dass wir für die vollständige Übereinstimmung keine Gewähr übernehmen. Die Angaben in dieser Druckschrift werden regelmäßig überprüft, und notwendige Korrekturen sind in den nachfolgenden Auflagen enthalten. Für Verbesserungsvorschläge sind wir dankbar.

Technische Änderungen vorbehalten.

MILLTRONICS ist eine eingetragene Marke der Siemens Milltronics Process Instruments

## Sicherheitstechnische Hinweise

Warnhinweise müssen zu Ihrer persönlichen Sicherheit sowie der Sicherheit Dritter und zur Vermeidung von Sachschäden beachtet werden. Zu jedem Warnhinweis wird der jeweilige Gefährdungsgrad angegeben.



**WARNUNG:** bezieht sich auf ein Warnsymbol auf dem Produkt und bedeutet, dass bei Nicht-Einhalt der entsprechenden Vorsichtsmaßnahmen Tod, schwere Körperverletzung und/oder erheblicher Sachschaden eintreten können.



**WARNUNG:** bedeutet, dass bei Nicht-Einhalt der entsprechenden Vorsichtsmaßnahmen Tod, schwere Körperverletzung und/oder erheblicher Sachschaden eintreten können.

**VORSICHT:** bedeutet, dass bei Nicht-Einhalt der entsprechenden Vorsichtsmaßnahmen erheblicher Sachschaden eintreten kann.

**Hinweis:** steht für eine wichtige Information über das Produkt selbst oder den Teil der Betriebsanleitung, auf den besonders aufmerksam gemacht werden soll.

Deutsch

## Gerätereparatur und Haftungsausschluss

- Der Anwender ist für alle vom Anwender oder seinem Bevollmächtigten durchgeführten Änderungen und Reparaturen am Gerät verantwortlich.
- Alle neuen Bestandteile sind von Siemens Milltronics Process Instruments Inc. bereit zu stellen.
- Reparieren Sie lediglich defekte Bestandteile.
- Defekte Bestandteile dürfen nicht wiederverwendet werden.



# Einleitung

**Dieses Produkt ist vorgesehen zum Gebrauch in Industrieumgebungen. Bei Verwendung in Wohngebieten kann es zu Störungen von verschiedenen Funkanwendungen kommen.**

Die Ultraschallsensoren Baureihe Echomax XPS/XCT werden zusammen mit Siemens Miltronics Ultraschall-Füllstandmessumformern betrieben.

Der Sensor wandelt die elektrische Energie des Sendeimpulses vom Messumformer in akustische Energie um. Die akustische Energie des Echos wird dann wieder in elektrische Energie für den Messumformer zurückgewandelt.

Die akustische Energie wird von der Sensorendfläche nach außen gestrahlt. Ihre Amplitude nimmt dabei mit einer Geschwindigkeit ab, die zum Quadrat des Abstands umgekehrt proportional ist. Die maximale Leistung erhält man an der sogenannten Übertragungsachse, senkrecht zur Sensorendfläche. An der Stelle, wo die Leistung nur noch halb so groß ist ( $-3$  dB), entsteht ein Kegel, der die Schallkeule definiert und dessen Mittellinie die Übertragungsachse darstellt. Sein Durchmesser entspricht dem Schallkegel.

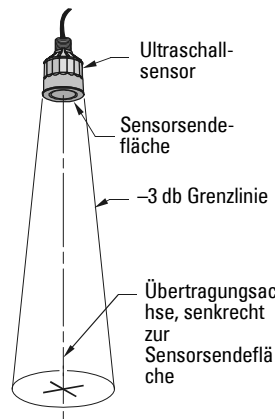

Die XPS/XCT Sensoren sind mit einem integrierten Temperaturfühler ausgestattet. Dieser meldet dem Messumformer die Temperatur am Ultraschallsensor.

## Allgemeine Richtlinien



**WARNUNG:** Die Werkstoffe werden entsprechend ihrer chemischen Beständigkeit (oder Trägheit) für allgemeine Zwecke gewählt. Bei Einsatz in besonderen Umgebungen prüfen Sie vor Installation die chemische Beständigkeit anhand einschlägiger Tabellen.

### Baureihe XPS/XCT – SIRA Zertifikat 99ATEX5153X

Diese Betriebsmittel können in explosionsgefährdeten Bereichen in Verbindung mit jedem Gas und jeweils in den Temperaturbereichen T1, T2, T3 und T4 für die Baureihe XPS (XPS-10, XPS-15, XPS-30 und XPS-40) oder T1, T2 und T3 für die Baureihe XCT (XCT-8 und XCT-12) eingesetzt werden. Die Zulassung der Baureihe XPS beschränkt sich auf den Einsatz bei Umgebungstemperaturen von  $-40$  °C bis  $95$  °C, die der Baureihe XCT auf den Einsatz bei Umgebungstemperaturen von  $-40$  °C bis  $145$  °C. Diese Grenzwerte dürfen keinesfalls überschritten werden.

Die Installation darf nur durch geschultes Personal und in Übereinstimmung mit den geltenden Verfahrensregeln durchgeführt werden.

Die Versorgungsspannung dieser Betriebsmittel muss von einem Schaltkreis kommen, der eine geeignete Sicherung mit einer Kurzschlusskapazität von 4000A enthält. Messumformer von Siemens Milltronics sind mit dieser Sicherung ausgestattet.

Die Reparatur dieser Geräte darf nur in Übereinstimmung mit den geltenden Verfahrensregeln durchgeführt werden.

Die Zertifizierung dieser Betriebsmittel beruht auf folgenden verwendeten Werkstoffen:

	Baureihe XPS	Baureihe XCT
Gehäuse	Kynar® 710	Kynar® 710
Vergusswerkstoff	Stycast LA-9823-76	Durapot® 861-F3 & 864

1. Kynar® ist eine eingetragene Marke von ELF Atochem.  
Durapot® ist eine eingetragene Marke von Cotronics Corporation.

Ein manuelles Ausschalten ist mit dem Leitungsschutzschalter möglich, der kundenseitig am zugehörigen Messumformer installiert ist.

### Baureihe XPS 30/40 – SIRA Zertifikat 01ATEX5153X

Diese Betriebsmittel können in staubexplosionsgefährdeten Bereichen mit leitenden und nichtleitenden Stäuben jeder Art eingesetzt werden. Die Ultraschallsensoren der Baureihe XPS-30 und XPS-40 weisen eine maximale Oberflächentemperatur von 135 °C (275 °F) auf (Temperaturklasse T4). Die Zulassung dieser Geräte gilt für den Einsatz bei Umgebungstemperaturen von -40 bis 95 °C (-40 bis 203 °F). Diese Grenzwerte dürfen keinesfalls überschritten werden. Die Ultraschallsensoren der Baureihe XPS-30 und XPS-40 müssen so installiert werden, dass die Sendefläche keiner direkten Lichtquelle ausgesetzt ist.

Die Installation darf nur durch geschultes Personal und in Übereinstimmung mit den geltenden Verfahrensregeln durchgeführt werden. Die Reparatur dieser Geräte darf nur in Übereinstimmung mit den geltenden Verfahrensregeln und Installationsanleitungen durchgeführt werden.

Die Versorgungsspannung dieser Betriebsmittel muss von einem Schaltkreis kommen, der eine geeignete Sicherung mit einer Kurzschlusskapazität von 4000A enthält. Messumformer von Siemens Milltronics sind mit dieser Sicherung ausgestattet.

Die Zertifizierung dieser Betriebsmittel beruht auf folgenden verwendeten Werkstoffen:

Gehäuse	Kynar® 710
Vergusswerkstoff	Stycast LA-9823-76

Ein manuelles Ausschalten ist mit dem Leitungsschutzschalter möglich, der kundenseitig am zugehörigen Messumformer installiert ist.



## Produktkennzeichnung



**Hinweis:** Kynar® Polyvinylidenflourid ist unter den beschriebenen Betriebsbedingungen gegen die meisten Chemikalien beständig. Vor der Installation sollten Sie jedoch, bei Einsatz in besonderen Umgebungen, die chemische Beständigkeit anhand einschlägiger Tabellen prüfen.

**WARNUNG:** Dieses Produkt wird als druckhaltendes Ausrüstungsteil im Sinne der Richtlinie 97/23 / EG bezeichnet und ist **nicht** für den Einsatz als Sicherheitsvorrichtung bestimmt.







## XCT-8

<b>SIEMENS</b>		 
<b>XCT-8 ULTRASONIC TRANSDUCER</b> Serial No: GYZ / A1034567 Ambient Temp.: -40 °C to 145 °C V in: 1.77 V r.m.s.; 250 Vp I in: 44.2 mA r.m.s.		
Siemens Milltronics Process Instruments, Peterborough		Enclosure: IP66, IP68  ATENÇÃO - RISCO POTENCIAL DE CARGA ELETROSTÁTICA - VEJA INSTRUÇÕES

	Class I, Zone 1, Ex s I T4, Amb. Temp.: -40°C to 95°C Ex s IIC T3, Amb. Temp.: -40°C to 145°C DIP IP65 / IP67 ANZEx 08.3066X	
	Ex mb IIIC T3 Gb Ex tb IIIC T135 °C Db DNV 12.0077 X	

## XCT-12



<b>SIEMENS</b>		
<b>XCT-12 ULTRASONIC TRANSDUCER</b> Serial No: GYZ / A1034567 Ambient Temp.: -40 °C to 145 °C V in: 1.77 V r.m.s.; 250 Vp I in: 44.2 mA r.m.s.		
Siemens Milltronics Process Instruments, Peterborough		Enclosure: IP66, IP68  Ex mb IIIC T3 Gb Ex tb IIIC T135 °C Db DNV 12.0077 X

	Class I, Div 2, Group A, B, C, D Class II, Div 2, Group F, G Per Dwg.: 0-9650017Z-DI-A Max. Torque: 15 FT-LBS		Class I, Zone 1 Ex s I T4, Amb. Temp.: -40° C to 95°C Ex s IIC T3, Amb. Temp.: -40°C to 145°C DIP IP65 / IP67 ANZEx 08.3066X	
	ATENÇÃO - RISCO POTENCIAL DE CARGA ELETROSTÁTICA - VEJA INSTRUÇÕES		<b>WARNING:</b> Static Hazard, Do Not Rub With Dry Cloth.	

### Hinweis:

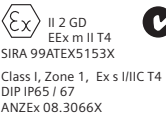

- Die Artikelnummer des Produkts ist nur beispielshalber aufgeführt.
- Die Seriennummer ist nur beispielshalber aufgeführt.

## XPS-10

SIEMENS	
<b>XPS-10 ULTRASONIC TRANSDUCER</b> Serial No: GYZ / A1034567 Ambient Temp.: - 40 °C to 95 °C V in : 1.77 V r.m.s.; 250 Vp I in : 44.2 mA r.m.s. Siemens Milltronics Process Instruments, Peterborough	 

 Class I, Div 2, Group A, B, C, D Class II, Div 1, Group E, F, G Per Dwg.: 0-9650017Z-DI-A Max. Torque: 15 FT-LBS	<b>WARNING:</b> Static Hazard, Do Not Rub With Dry Cloth.  <b>Segurança</b>  Ex mb IIC T4 Gb Ex tb IIIC T135 °C Db DNV 12.0077 X
--	--

## XPS-15

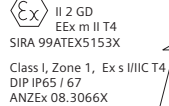
SIEMENS	
<b>XPS-15 ULTRASONIC TRANSDUCER</b> Serial No: GYZ / A1034567 Ambient Temp.: - 40°C to 95°C V in : 1.77 V r.m.s.; 250 Vp I in : 44.2 mA r.m.s. Enclosure: IP66, IP68 Siemens Milltronics Process Instruments, Peterborough	  



<b>Segurança</b>  Ex mb IIC T4 Gb Ex tb IIIC T135 °C Db DNV 12.0077 X	 Class I, Div 2, Group A, B, C, D Class II, Div 1, Group E, F, G Per Dwg.: 0-9650017Z-DI-A Max. Torque: 15 FT-LBS <b>WARNING:</b> Static Hazard, Do Not Rub With Dry Cloth. <b>ATENÇÃO - RISCO POTENCIAL DE CARGA ELETROSTÁTICA - VEJA INSTRUÇÕES</b>
--	--

### Hinweis:

- Die Artikelnummer des Produkts ist nur beispielshalber aufgeführt.
- Die Seriennummer ist nur beispielshalber aufgeführt.



## XPS-30

SIEMENS	
<b>XPS-30 ULTRASONIC TRANSDUCER</b> Serial No: GYZ / A1034567 Ambient Temp.: - 40 °C to 95 °C V in: 1.77 V r.m.s.; 250 Vp I in: 44.2 mA r.m.s. Enclosure: IP66, IP68 Siemens Milltronics Process Instruments, Peterborough	   Class I, Zone 1, Ex s IIIC T4 DIP IP65 / 67 ANZEx 08.3066X

Segurança	
 Ex mb IIC T4 Gb Ex tb IIIC T135 °C Db DNV 12.0077 X	 Class I, Div 2, Group A, B, C, D Class II, Div 1, Group E, F, G Per Dwg.: 0-9650017Z-DI-A Max. Torque: 15 FT-LBS (20 N-m) <b>WARNING:</b> Static Hazard, Do Not Rub With Dry Cloth. <b>ATENÇÃO - RISCO POTENCIAL DE CARGA ELETROSTÁTICA - VEJA INSTRUÇÕES</b>

## XPS-40

SIEMENS	
<b>XPS-40 ULTRASONIC TRANSDUCER</b> Serial No: GYZ / A1034567 Ambient Temp.: - 40 °C to 95 °C V in: 1.77 V r.m.s.; 250 Vp I in: 44.2 mA r.m.s. Enclosure: IP66, IP68 Siemens Milltronics Process Instruments, Peterborough	   Class I, Zone 1, Ex s IIIC T4 DIP IP65 / 67 ANZEx 08.3066X

Segurança	
 Ex mb IIC T4 Gb Ex tb IIIC T135 °C Db DNV 12.0077 X	 Class I, Div 2, Group A, B, C, D Class II, Div 1, Group E, F, G Per Dwg.: 0-9650017Z-DI-A Max. Torque: 15 FT-LBS (20 N-m) <b>WARNING:</b> Static Hazard, Do Not Rub With Dry Cloth. <b>ATENÇÃO - RISCO POTENCIAL DE CARGA ELETROSTÁTICA - VEJA INSTRUÇÕES</b>

### Hinweis:

- Die Artikelnummer des Produkts ist nur beispielshalber aufgeführt.
- Die Seriennummer ist nur beispielshalber aufgeführt.

# Technische Daten

	XPS-10	XPS-15	XPS-30	XPS-40	XCT-8	XCT-12
Messbereich	0,3 - 10 m (1 - 33 ft)	0,3 - 15 m (1 - 50 ft)	0,6 - 30 m (2 - 100 ft)	0,9 - 40 m (3 - 130 ft)	0,6 - 8 m (2 - 26 ft)	0,6 - 12 m (2 - 40 ft)
Frequenz (kHz)	44	44	30	22	44	44
Schallkegel	12°	6°	6°	6°	12°	6°
Umgebungsbedingungen						
Einbauort	innen/im Freien	innen/im Freien	innen/im Freien	innen/im Freien	innen/im Freien	innen/im Freien
Max. Höhe (m)	2000	2000	2000	2000	2000	2000
Umgebungs-temperatur	-40 bis 95 °C (-40 bis 203 °F)	-40 bis 95 °C (-40 bis 203 °F)	-40 bis 95 °C (-40 bis 203 °F)	-40 bis 95 °C (-40 bis 203 °F)	-40 bis 145 °C (-40 bis 293 °F)	-40 bis 145 °C (-40 bis 293 °F)
Druck	8 bar (120 psi)	8 bar (120 psi)	Europa: 0,5 bar Nordamerika: 15 psi	Europa: 0,5 bar Nordamerika: 15 psi	8 bar (120 psi)	8 bar (120 psi)
Verschmutzungs-grad	4	4	4	4	4	4
Bauart						
Gehäuse	PVDF	PVDF	PVDF	PVDF	<b>Standard:</b> PVDF <b>Optional:</b> PTFE Beschichtung mit universellem* Flansch	
Montage	1" NPT oder BSP Gewinde	1" NPT oder BSP Gewinde	1-1/2" NPT oder BSP Gewinde	1-1/2" NPT oder BSP Gewinde	1" NPT oder BSP Gewinde	1" NPT oder BSP Gewinde
Optionen	<ul style="list-style-type: none"> <li>• werkseitig geflanscht, für ANSI, DIN und JIS Standard</li> <li>• mit Polyethylenschaum beschichtete Sendefläche für Umgebungen mit Staub- oder Dampfwicklung</li> <li>• Überflutungshülse, falls notwendig (nur für XPS-10, XPS-15)</li> <li>• geteilter Flansch für Feldmontage gemäß ANSI, DIN und JIS Standard (nicht verfügbar für XPS-40)</li> </ul>					
Kabel	2-adrig verdilltes Paar/Litze, geschirmt, 0,5 mm <sup>2</sup> (20 AWG), PVC-Mantel		<ul style="list-style-type: none"> <li>• 2-adrig verdilltes Paar/Litze, geschirmt, 0,5 mm<sup>2</sup> (20 AWG), PVC-Mantel <b>Max. Abstand:</b> 100 m (330 ft)</li> <li>• RG-62 A/U Koaxialkabel <b>Max. Abstand:</b> 365 m (1200 ft)</li> </ul>		Silikonmantel	
Gewicht**	0,8 kg (1,7 lb)	1,3 kg (2,8 lb)	4,3 kg (9,5 lb)	8 kg (18 lb)	0,8 kg (1,7 lb)	1,3 kg (2,8 lb)
Max. Abstand	365 m (1200 ft)	365 m (1200 ft)	365 m (1200 ft)	365 m (1200 ft)	365 m (1200 ft)	365 m (1200 ft)
Hilfsenergie	Betrieb der Sensoren nur an zugelassenen Siemens Milltronics Messumformern					
Zulassungen	CE***, CSA, FM, CENELEC/ATEX, INMETRO: Angaben zu gegenwärtigen Zulassungen erhalten Sie auf dem Typenschild oder von Siemens Milltronics.					

\* Universeller Flansch entsprechend ANSI, DIN und JIS Standards.

\*\* Ungefähres Versandgewicht des Sensors mit Standardkabellänge.

\*\*\* EMV Bescheinigung auf Anfrage erhältlich

# Maßbilder

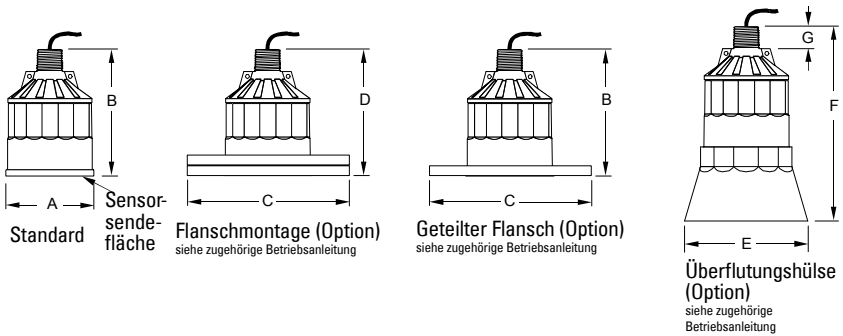

Maß	XPS 10	XPS-15	XPS-30	XPS-40	XCT-8	XCT-12
A	88 mm (3,4")	121 mm (4,8")	175 mm (6,9")	206 mm (8,1")	88 mm (3,4")	121 mm (4,8")
B	122 mm (4,8")	132 mm (5,2")	198 mm (7,8")	229 mm (9,0")	122 mm (4,8")	132 mm (5,2")
C	Gemäß ANSI, DIN und JIS					
D*	128 mm (5,0")	138 mm (5,4")	204 mm (8,0")	235 mm (9,2")	128 mm (5,0")	138 mm (5,4")
E	124 mm (4,9")	158 mm (6,2")	--	--	--	--
F	152 mm (6,0")	198 mm (7,8")	--	--	--	--
G	28 mm (1,1")	28 mm (1,1")	28 mm (1,1")	28 mm (1,1")	28 mm (1,1")	28 mm (1,1")

\* nominal



**WARNUNG:** Optionale Konfigurationen mit geteiltem Flansch, Flanschmontage und Verstellflansch sind **nicht** für Applikationen mit Druck geeignet.

# Montage

**WARNUNG:** Treffen Sie besondere Vorsichtsmaßnahmen, um die Sensor-  
sendefläche vor Beschädigung zu schützen.

- Beachten Sie bei der Sensormontage einen **Mindestabstand zum maximalen Materialfüllstand entsprechend der Nahbereichsausblendung**. Siehe zugehörige Betriebsanleitung des Messumformers.
- Bei Applikationen mit Flüssigkeiten ist der Sensor zu anzubringen, dass die Sendefläche parallel zur Flüssigkeitsoberfläche ist. Verwenden Sie bei Applikationen mit Schüttgütern einen Siemens Milltronics Verstellflansch, um die Ausrichtung des Sensors zu vereinfachen.
- Nicht zu stark anziehen. Bei den meisten Applikationen genügt es, das Gewinde von Hand zu befestigen. Bringen Sie eine Sicherungskette zwischen dem Sensor und einem festen Bauteil an. Verwenden Sie ggf. einen optionalen **Temperaturfühler**: bei einem Sensor in Flanschausführung, wenn eine schnelle Reaktion auf Temperaturänderungen erforderlich ist oder in Behältern mit hoher Temperatur.

**Hinweis:** Um die Druckdichtigkeit bei Applikationen zu gewährleisten, ziehen Sie die Sensoren handfest an und dann noch um  $\frac{1}{2}$  bis  $1\frac{1}{2}$  Umdrehungen. Für Druckbehälter ist die Verwendung von PTFE Band (oder anderem geeigneten Dichtungsstoff) möglich, um die Gewinde besser abzudichten.

## Montage – Applikationen mit Schüttgütern

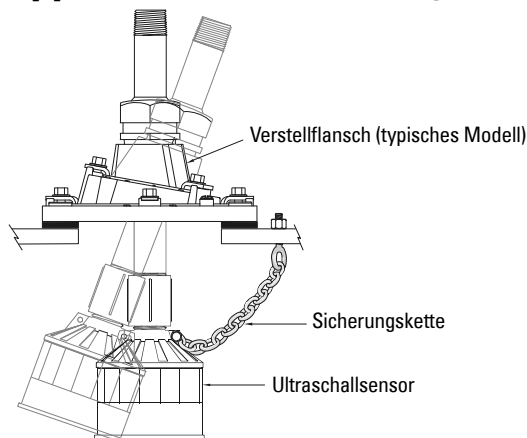

**WARNUNG:** Eine unsachgemäße Installation kann zu Druckverlust im Prozess führen.



# Montage – Applikationen mit Flüssigkeiten

## Abgehängte Montage

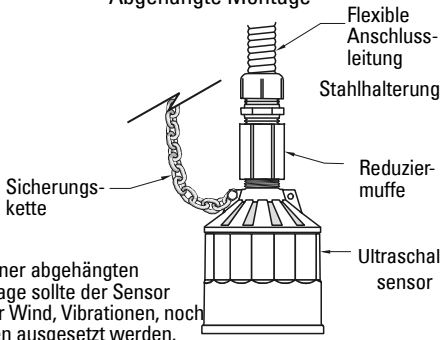

Bei einer abgehängten Montage sollte der Sensor weder Wind, Vibrationen, noch Stößen ausgesetzt werden.

## Halterung

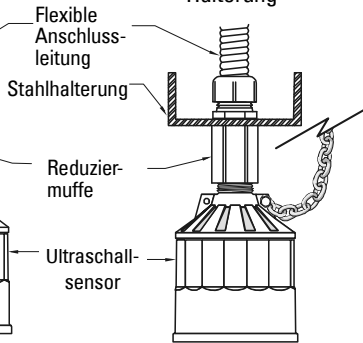

## Überflutbar

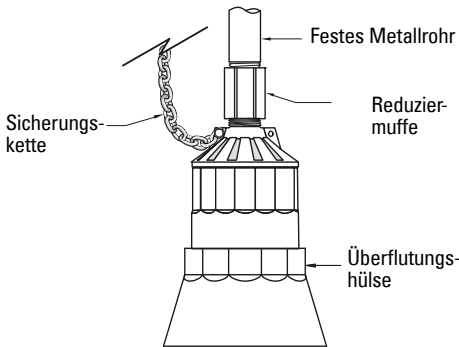

Sensör mit Überflutungshülse für Applikationen mit Überflutungsgefahr.

## Sperrholz

Eine Sperrholzmontage ergibt eine ausgezeichnete Isolierung, muss aber stabil genug sein, um bei Belastung ein Durchhängen zu vermeiden.

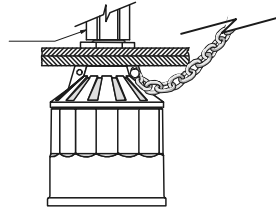

# Montage – Applikationen mit Flüssigkeiten (Fortsetz.)

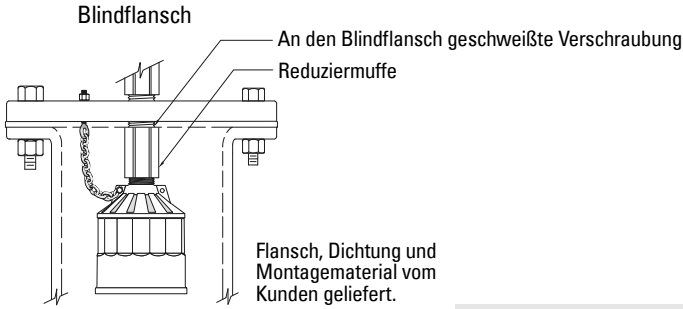

**Hinweis:** Ziehen Sie die Flanschschrauben gleichmäßig an, um eine gute Abdichtung zwischen den Gegenflanschen zu gewährleisten.

**Vorsicht: Durch zu starkes Anziehen wird die Leistung des Sensors beeinträchtigt.**

## Flanschmontage

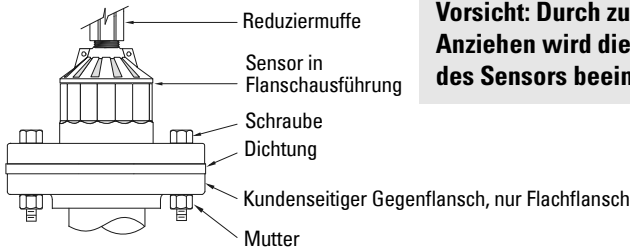

Standrohr mit kundenseitigem Flansch. Angaben zum Anschweißen eines Metallflansches an das Rohr finden Sie im *Applikationshandbuch Ultraschallsensoren* unter Applikationen mit Flüssigkeiten - Standrohr.

# Installation

**Hinweis:** Die Installation darf nur durch qualifiziertes Personal und unter Beachtung der örtlichen, gesetzlichen Bestimmungen durchgeführt werden.

- Die Kabel sollten nicht offen verlegt werden. Zur optimalen Störsicherheit sind die Kabel getrennt in einem geerdeten Metallrohr zu verlegen. Alle Gewindeanschlüsse sind so abzudichten, dass das Eindringen von Feuchtigkeit verhindert wird.
- Vermeiden Sie eine Leitungsführung in der Nähe von Hochspannungs-, Motorleitungen, Schaltschützen oder Frequenzumrichtern (SCR Steuerantriebe). Für Applikationen mit Druckdichte ziehen Sie die Sensoren handfest an und dann noch um ½ bis 1½ Umdrehungen.
- Für Druckbehälter ist die Verwendung von PTFE Band (oder anderem geeigneten Dichtungsstoff) möglich, um die Gewinde besser abzudichten.



**WARNUNG:** Versuchen Sie niemals die Prozessdichtung zu lockern, zu entfernen oder auseinanderzubauen, während der Inhalt des Behälters unter Druck steht.

# Anschluss

## Direkter Anschluss

Schließen Sie den Ultraschallsensor über das zwei-adrige, geschirmte Kabel direkt an den Siemens Milltronics Messumformer an.

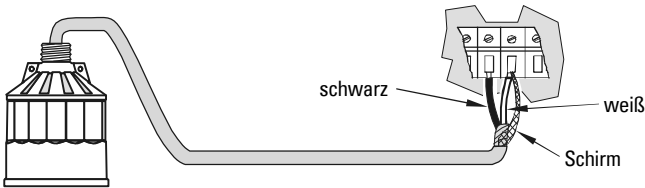

**Hinweis:** Bei Anschluss eines SITRANS LUT400, SITRANS LUC500, MultiRanger 100/200, oder HydroRanger 200 werden die Drähte weiß, schwarz und Schirm getrennt angeschlossen. Der Schirm und der weiße Draht dürfen NICHT gemeinsam angeschlossen werden.

## Koaxialanschluss

Schließen Sie den Ultraschallsensor über einen Anschlusskasten und ein RG-62 A/U Koaxialkabel an den Siemens Milltronics Messumformer an. Diese Anordnung gilt für eine Gesamtlänge von 365 m (1200 ft).

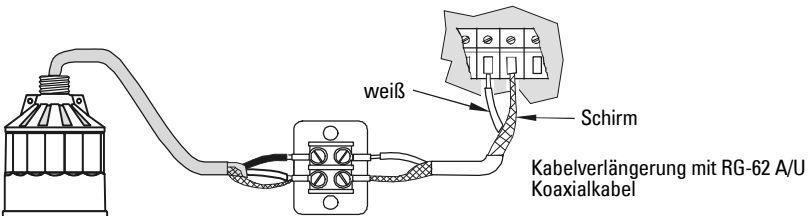

**Hinweis:** Bei Anschluss eines SITRANS LUT400, SITRANS LUC500, MultiRanger 100/200, oder HydroRanger 200 sollte KEIN Koaxialkabel verwendet werden. Siehe Zeichnung unten für die richtige Vorgehensweise.

## 2-adrige Verlängerung

(nur für SITRANS LUT400, SITRANS LUC500, MultiRanger 100/200 und HydroRanger 200)

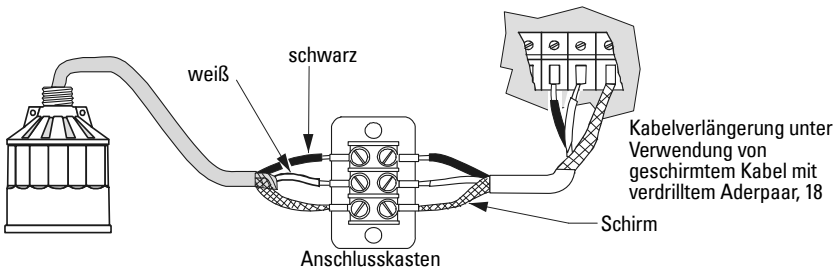



# Εγχειρίδιο χρήσης Echomax XPS/XCT

Το παρόν εγχειρίδιο περιγράφει τα βασικά χαρακτηριστικά και λειτουργίες των μορφοτροπέων της σειράς Echomax XPS/XCT. Το παρόν εγχειρίδιο, και το *Εγχειρίδιο Εφαρμογών Μορφοτροπέων* διατίθεται και στην τοποθεσία μας web: [www.siemens.com/processautomation](http://www.siemens.com/processautomation). Αντίγραφα σε έντυπη μορφή διατίθενται από τον τοπικό αντιπρόσωπο της Siemens Milltronics.

**Ερωτήσεις σχετικά με τα περιεχόμενα του εγχειριδίου αυτού μπορείτε να απευθύνετε προς τη:**

Siemens Milltronics Process Instruments  
1954 Technology Drive, P.O. Box 4225  
Peterborough, Ontario, Canada, K9J 7B1  
Email: [techpubs.smpi@siemens.com](mailto:techpubs.smpi@siemens.com)

**Εξουσιοδοτημένος αντιπρόσωπος στην Ευρώπη**

Siemens AG  
Industry Sector  
76181 Karlsruhe  
Deutschland

Πνευματικά δικαιώματα: Siemens Milltronics Process Instruments 2013.  
Με την επιφύλαξη παντός δικαιώματος

Δήλωση αποποίησης

Παροτρύνουμε τους χρήστες να αγοράζουν εξουσιοδοτημένα έντυπα εγχειρίδια ή να ανατρέχουν σε ηλεκτρονικές εκδόσεις των εγχειριδίων που έχουν δημιουργηθεί και εγκριθεί από τη Siemens Milltronics Process Instruments. Η Siemens Milltronics Process Instruments δεν φέρει ευθύνη για τα περιεχόμενα των αντιγράφων ολόκληρου ή μέρους του αναπαραχθέντος εγχειριδίου, ανεξάρτητα από το αν πρόκειται για ηλεκτρονική έκδοση ή εκτυπωμένο αντίγραφο.

Παρόλο που έχουμε ελέγξει ότι τα περιεχόμενα του παρόντος εγχειριδίου συμφωνούν με τα όργανα που περιγράφονται, τυχόν διαφοροποιήσεις είναι πιθανές. Επομένως, δεν μπορούν να εγγυηθούμε πλήρη συμφωνία μεταξύ των περιεχομένων του και της συσκευής που αγοράσατε. Τα περιεχόμενα του εγχειριδίου αυτού επανεξετάζονται σε τακτά χρονικά διαστήματα και οι διορθώσεις ενσωματώνονται στις νέες εκδόσεις του. Κάθε πρόταση για τυχόν βελτιώσεις είναι ευπρόσδεκτη.

Τα τεχνικά χαρακτηριστικά υπόκεινται σε τροποποιήσεις.

Το MILLTRONICS είναι σήμα κατατεθέν της Siemens Milltronics Process Instruments

## Οδηγίες ασφαλείας

Οι προειδοποιητικές υποδείξεις πρέπει να τηρούνται προκειμένου να διασφαλίζεται η προσωπική σας ασφάλεια και η ασφάλεια τρίτων καθώς και να προστατεύεται το προϊόν και ο συνδεδεμένος με αυτό εξοπλισμός. Οι προειδοποιητικές υποδείξεις συνοδεύονται από μια επεξήγηση σχετικά με το βαθμό της προφύλαξης που πρέπει να λαμβάνεται.



**ΠΡΟΕΙΔΟΠΟΙΗΣΗ:** σχετίζεται με ένα προειδοποιητικό σύμβολο πάνω στο προϊόν και σημαίνει ότι η μη τήρηση των απαιτούμενων προφυλάξεων μπορεί να προκαλέσει θάνατο, σοβαρό τραυματισμό ή/και σημαντικές υλικές ζημιές.



**ΠΡΟΕΙΔΟΠΟΙΗΣΗ:** σημαίνει ότι η μη τήρηση των απαιτούμενων προφυλάξεων μπορεί να προκαλέσει θάνατο, σοβαρό τραυματισμό ή/και σημαντικές υλικές ζημιές.

**ΠΡΟΣΟΧΗ:** σημαίνει ότι η μη τήρηση των απαιτούμενων προφυλάξεων μπορεί να προκαλέσει σημαντικές υλικές ζημιές.

**Σημείωση:** σημαίνει σημαντικές πληροφορίες σχετικά με το προϊόν ή με το συγκεκριμένο τμήμα του εγχειριδίου χρήσης.

## Επισκευή μονάδας και αποκλειόμενη ευθύνη

- Ο χρήστης είναι υπεύθυνος για όλες τις μετατροπές και επισκευές που πραγματοποιούνται στη συσκευή από το χρήστη ή τον αντιπρόσωπό του.
- Όλα τα καινούργια εξαρτήματα παρέχονται από τη Siemens Milltronics Process Instruments Inc.
- Περιορίστε τις επισκευές μόνο στα ελαττωματικά εξαρτήματα.
- Μην επαναχρησιμοποιείτε ελαττωματικά εξαρτήματα.

# Εισαγωγή

Το προϊόν αυτό προορίζεται για χρήση σε βιομηχανικό περιβάλλον. Η λειτουργία του παρόντος εξοπλισμού σε κατοικημένη περιοχή ενδέχεται να προκαλέσει παρεμβολές σε ορισμένες ραδιοεπικοινωνίες.

Η σειρά μορφοτροπέων Echomax XPS/XCT λειτουργεί σε συνδυασμό με τα προϊόντα παρακολούθησης στάθμης με υπέρηχους της Siemens Milltronics.

Ο μορφοτροπέας μετατρέπει τον ηλεκτρικό παλμό εκπομπής από τον πομποδέκτη σε ηχητική ενέργεια. Στη συνέχεια, μετατρέπει ξανά την ηχητική ενέργεια της ηχούς σε ηλεκτρική ενέργεια για τον ελεγκτή.

Η επιφάνεια του μορφοτροπέα εκπέμπει ηχητική ενέργεια που ακτινοβολείται προς τα έξω, και το πλάτος της οποίας μειώνεται σε ποσοστό αντιστρόφως ανάλογο προς το τετράγωνο της απόστασης. Η μέγιστη ισχύς ακτινοβολείται κάθετα από την επιφάνεια του μορφοτροπέα, πάνω στον άξονα εκπομπής. Στο σημείο όπου η ισχύς μειώνεται κατά το ήμισυ ( $-3 \text{ dB}$ ), ένας κωνικά οριοθετημένος χώρος, κεντραρισμένος γύρω από τον άξονα εκπομπής, καθορίζει την ηχητική δέσμη, η διάμετρος της οποίας αποτελεί τη γωνία της δέσμης.

Οι μορφοτροπέες XPS/XCT διαθέτουν ενσωματωμένο αισθητήρα θερμοκρασίας αέρα που μεταδίδει προς τον ελεγκτή τη θερμοκρασία αέρα που μετρείται στο μορφοτροπέα.

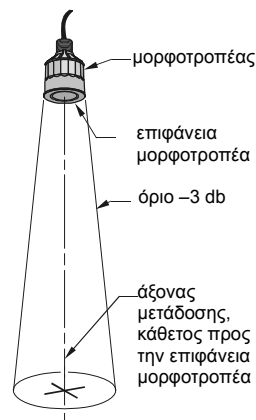

## Γενικές οδηγίες



**ΠΡΟΕΙΔΟΠΟΙΗΣΗ:** Τα υλικά κατασκευής έχουν επιλεγεί με βάση τη χημική τους συμβατότητα (ή αδράνεια) για γενική χρήση. Σε ό,τι αφορά την έκθεση σε συγκεκριμένο περιβάλλον, αντιπαραβάλετε με τους πίνακες χημικής συμβατότητας, προτού προχωρήσετε στην εγκατάσταση.

### Σειρά XPS/XCT – Πιστοποιητικό SIRA 99ATEX5153X

Ο παρών εξοπλισμός μπορεί να χρησιμοποιηθεί σε επικίνδυνες περιοχές σε συνδυασμό με όλα τα αέρια με κατηγορίες θερμοκρασίας T1, T2, T3 και T4 για τη σειρά XPS (XPS-10, XPS-15, XPS-30 και XPS-40) και με κατηγορίες θερμοκρασίας T1, T2 και T3 για τη σειρά XCT (XCT-8 και XCT-12). Η σειρά XPS έχει πιστοποιηθεί μόνο για χρήση σε θερμοκρασία περιβάλλοντος, στην περιοχή τιμών από  $-40 \text{ }^\circ\text{C}$  έως  $95 \text{ }^\circ\text{C}$  και η σειρά XCT έχει πιστοποιηθεί μόνο για χρήση σε θερμοκρασία περιβάλλοντος, στην περιοχή τιμών από  $-40 \text{ }^\circ\text{C}$  έως  $145 \text{ }^\circ\text{C}$ . Καμία από τις δύο σειρές δεν θα πρέπει να χρησιμοποιείται εκτός του αντίστοιχου θερμοκρασιακού εύρους λειτουργίας τους.

Η εγκατάστασή τους θα πρέπει να πραγματοποιείται σύμφωνα με τον εφαρμοστέο κώδικα πρακτικής από κατάλληλα εκπαιδευμένο προσωπικό.

Οι συσκευές αυτές θα πρέπει να τροφοδοτούνται μόνο από κύκλωμα που περιλαμβάνει κατάλληλη ασφάλεια με ικανότητα διακοπής 4000 A. Η ασφάλεια αυτή περιλαμβάνεται στους ελεγκτές Siemens Milltronics.

Ο παρών εξοπλισμός θα πρέπει να επισκευάζεται σύμφωνα με τον εφαρμοστέο κώδικα πρακτικής.

Η πιστοποίηση του παρόντος εξοπλισμού στηρίζεται στα εξής υλικά που χρησιμοποιήθηκαν για την κατασκευή του:

	Σειρά XPS	Σειρά XCT
<b>Περιβλήμα</b>	Kynar® 710	Kynar® 710
<b>Ενθυλακωτικό</b>	Stycast LA-9823-76	Duraprot® 861-F3 & 864

1. Το Kynar® είναι σήμα κατατεθέν της ELF Atochem.  
Το Duraprot® είναι σήμα κατατεθέν της Cotronics Corporation.

Για χειροκίνητη παράκαμψη, χρησιμοποιήστε το διακόπτη αποσύνδεσης που παρέχεται στην κτιριακή εγκατάσταση του αντίστοιχου ελεγκτή.

### Σειρά XPS 30/40 – Πιστοποιητικό SIRA 01ATEX5153X

Ο παρών εξοπλισμός μπορεί να χρησιμοποιηθεί σε επικίνδυνες περιοχές με όλες τις αγωγίμες και μη σκόνες. Οι μορφοτροπείς των τύπων XPS-30 και XPS-40 έχουν μέγιστη επιφανειακή θερμοκρασία 135 °C (275 °F) (Κατηγορία Θερμοκρασίας T4). Οι μονάδες αυτές έχουν πιστοποιηθεί για χρήση στο εύρος θερμοκρασιών περιβάλλοντος -40 έως 95 °C (-40 έως 203 °F). Οι μορφοτροπείς δεν θα πρέπει να χρησιμοποιούνται εκτός αυτού του εύρους θερμοκρασίας. Οι μορφοτροπείς υπερήχων XPS-30 και XPS-40 πρέπει να εγκαθίστανται κατά τέτοιο τρόπο, ώστε η επιφάνεια του μορφοτροπέα να μην εκτίθεται σημαντικά σε φως.

Η εγκατάστασή τους θα πρέπει να πραγματοποιείται σύμφωνα με τον εφαρμοστέο κώδικα πρακτικής από κατάλληλα εκπαιδευμένο προσωπικό. Ο εξοπλισμός θα πρέπει να επισκευάζεται σύμφωνα με τον εφαρμοστέο κώδικα πρακτικής και τις οδηγίες εγκατάστασης.

Οι συσκευές αυτές θα πρέπει να τροφοδοτούνται μόνο από κύκλωμα που περιλαμβάνει κατάλληλη ασφάλεια με ικανότητα διακοπής 4000 A. Η ασφάλεια αυτή περιλαμβάνεται στους ελεγκτές Siemens Milltronics.

Η πιστοποίηση του παρόντος εξοπλισμού στηρίζεται στα εξής υλικά που χρησιμοποιήθηκαν για την κατασκευή του:

<b>Περιβλήμα:</b>	Kynar® 710
<b>Ενθυλακωτικό:</b>	Stycast LA-9823-76

Για χειροκίνητη παράκαμψη, χρησιμοποιήστε το διακόπτη αποσύνδεσης που παρέχεται στην κτιριακή εγκατάσταση του σχετικού ελεγκτή.

### Σήμανση προϊόντος



**Σημείωση:** Το φθοριούχο πολυβινυλιδένιο Kynar® είναι ανθεκτικό στις περισσότερες χημικές ουσίες, υπό τις περιγραφόμενες συνθήκες λειτουργίας. Ωστόσο, σε ό,τι αφορά την έκθεση σε συγκεκριμένο περιβάλλον, αντιπαραβάλετε με τους πίνακες χημικής συμβατότητας, προτού προχωρήσετε στην εγκατάσταση.



**ΠΡΟΕΙΔΟΠΟΙΗΣΗ:** Το παρόν προϊόν χαρακτηρίζεται ως Εξάρτημα Υπό Πίεση, όπως ορίζεται από την Οδηγία 97/23/ΕΚ και δεν προορίζεται για χρήση ως συσκευή ασφαλείας.









## XCT-8

SIEMENS	
<b>XCT-8 ULTRASONIC TRANSDUCER</b> Serial No: GYZ / A1034567 Ambient Temp.: -40 °C to 145 °C V in: 1.77 V r.m.s.; 250 Vp I in: 44.2 mA r.m.s.	 
Enclosure: IP66, IP68	 <b>ATENÇÃO - RISCO POTENCIAL DE CARGA ELETROSTÁTICA - VEJA INSTRUÇÕES</b>
Siemens Milltronics Process Instruments, Peterborough	

Segurança	
 Ex mb IIIC T3 Gb Ex tb IIIC T135 °C Db DNV 12.0077 X	Class I, Zone 1, Ex s I T4, Amb. Temp.: -40°C to 95°C Ex s II C T3, Amb. Temp.: -40°C to 145°C DIP IP65 / IP67 ANZEx 08.3066X <b>WARNING:</b> Static Hazard, Do Not Rub With Dry Cloth.
	 Class I, Div 2, Group A, B, C, D Class II, Div 2, Group F, G Per Dwg.: 0-9650017Z-DI-A Max. Torque: 15 FT-LBS

## XCT-12



SIEMENS	
<b>XCT-12 ULTRASONIC TRANSDUCER</b> Serial No: GYZ / A1034567 Ambient Temp.: -40 °C to 145 °C V in: 1.77 V r.m.s.; 250 Vp I in: 44.2 mA r.m.s.	 <b>Segurança</b> 
Enclosure: IP66, IP68	Ex mb IIIC T3 Gb Ex tb IIIC T135 °C Db DNV 12.0077 X
Siemens Milltronics Process Instruments, Peterborough	

FM APPROVED	
 Class I, Div 2, Group A, B, C, D Class II, Div 2, Group F, G Per Dwg.: 0-9650017Z-DI-A Max. Torque: 15 FT-LBS	 Class I, Zone 1 Ex s I T4, Amb. Temp.: -40°C to 95°C Ex s II C T3, Amb. Temp.: -40°C to 145°C DIP IP65 / IP67 ANZEx 08.3066X
<b>ATENÇÃO - RISCO POTENCIAL DE CARGA ELETROSTÁTICA - VEJA INSTRUÇÕES</b>	

### Σημείωση:



- Ο αριθμός διαμόρφωσης του προϊόντος είναι ενδεικτικός.
- Ο αριθμός σειράς είναι ενδεικτικός.

## XPS-10

SIEMENS	
<b>XPS-10 ULTRASONIC TRANSDUCER</b> Serial No: GYZ / A1034567 Ambient Temp.: - 40 °C to 95 °C V in : 1.77 V r.m.s.; 250 Vp I in : 44.2 mA r.m.s. Enclosure: IP66, IP68 Siemens Milltronics Process Instruments, Peterborough	 II 2 GD EEx m II T4 SIRA 99ATEX5153X Class I, Zone 1, Ex s IIIC T4 DIP IP65 / 67 ANZEx 08.3066X  0518 

 Class I, Div 2, Group A, B, C, D Class II, Div 1, Group E, F, G Per Dwg.: 0-9650017Z-DI-A Max. Torque: 15 FT-LBS	<b>WARNING:</b> Static Hazard, Do Not Rub With Dry Cloth.  <b>Segurança</b>  Ex mb IIC T4 Gb Ex tb IIIC T135 °C Db DNV 12.0077 X
--	--

## XPS-15

SIEMENS	
<b>XPS-15 ULTRASONIC TRANSDUCER</b> Serial No: GYZ / A1034567 Ambient Temp.: - 40°C to 95°C V in: 1.77 V r.m.s.; 250 Vp I in : 44.2 mA r.m.s. Enclosure: IP66, IP68 Siemens Milltronics Process Instruments, Peterborough	 0518  II 2 GD EEx m II T4 SIRA 99ATEX5153X Class I, Zone 1, Ex s IIIC T4 DIP IP65 / 67 ANZEx 08.3066X



<b>Segurança</b>  Ex mb IIC T4 Gb Ex tb IIIC T135 °C Db DNV 12.0077 X	 Class I, Div 2, Group A, B, C, D Class II, Div 1, Group E, F, G Per Dwg.: 0-9650017Z-DI-A Max. Torque: 15 FT-LBS <b>WARNING:</b> Static Hazard, Do Not Rub With Dry Cloth. <b>ATENÇÃO - RISCO POTENCIAL DE CARGA ELETROSTÁTICA - VEJA INSTRUÇÕES</b>
--	--

### Σημείωση:

- Ο αριθμός διαμόρφωσης του προϊόντος είναι ενδεικτικός.
- Ο αριθμός σειράς είναι ενδεικτικός.



## XPS-30

SIEMENS	
<b>XPS-30 ULTRASONIC TRANSDUCER</b> Serial No: GYZ / A1034567 Ambient Temp.: - 40 °C to 95 °C V in: 1.77 V r.m.s.; 250 Vp I in: 44.2 mA r.m.s. Enclosure: IP66, IP68 Siemens Milltronics Process Instruments, Peterborough	   Class I, Zone 1, Ex s II/II C T4 DIP IP65 / 67 ANZEx 08.3066X

Segurança	
 Ex mb IIC T4 Gb Ex tb IIIC T135 °C Db DNV 12.0077 X	 Class I, Div 2, Group A, B, C, D Class II, Div 1, Group E, F, G Per Dwg.: 0-9650017Z-DI-A Max. Torque: 15 FT-LBS (20 N-m) <b>WARNING:</b> Static Hazard, Do Not Rub With Dry Cloth. ATENÇÃO - RISCO POTENCIAL DE CARGA ELETROSTÁTICA - VEJA INSTRUÇÕES

## XPS-40

SIEMENS	
<b>XPS-40 ULTRASONIC TRANSDUCER</b> Serial No: GYZ / A1034567 Ambient Temp.: - 40 °C to 95 °C V in: 1.77 V r.m.s.; 250 Vp I in: 44.2 mA r.m.s. Enclosure: IP66, IP68 Siemens Milltronics Process Instruments, Peterborough	   Class I, Zone 1, Ex s II/II C T4 DIP IP65 / 67 ANZEx 08.3066X

Segurança	
 Ex mb IIC T4 Gb Ex tb IIIC T135 °C Db DNV 12.0077 X	 Class I, Div 2, Group A, B, C, D Class II, Div 1, Group E, F, G Per Dwg.: 0-9650017Z-DI-A Max. Torque: 15 FT-LBS (20 N-m) <b>WARNING:</b> Static Hazard, Do Not Rub With Dry Cloth. ATENÇÃO - RISCO POTENCIAL DE CARGA ELETROSTÁTICA - VEJA INSTRUÇÕES

### Σημείωση:

- Ο αριθμός διαμόρφωσης του προϊόντος είναι ενδεικτικός.
- Ο αριθμός σειράς είναι ενδεικτικός.

# Προδιαγραφές

	XPS-10	XPS-15	XPS-30	XPS-40	XCT-8	XCT-12
<b>Φάσμα τιμών μέτρησης</b>	0,3 - 10 m (1 - 33 ft)	0,3 - 15 m (1 - 50 ft)	0,6 - 30 m (2 - 100 ft)	0,9 - 40 m (3 - 130 ft)	0,6 - 8 m (2 - 26 ft)	0,6 - 12 m (2 - 40 ft)
<b>Συχνότητα (kHz)</b>	44	44	30	22	44	44
<b>Γωνία δέσμης</b>	12°	6°	6°	6°	12°	6°
<b>Στοιχεία περιβάλλοντος</b>						
<b>Θέση</b>	σε εσωτερικό χώρο / σε εξωτερικό χώρο	σε εσωτερικό χώρο / σε εξωτερικό χώρο	σε εσωτερικό χώρο / σε εξωτερικό χώρο	σε εσωτερικό χώρο / σε εξωτερικό χώρο	σε εσωτερικό χώρο / σε εξωτερικό χώρο	σε εσωτερικό χώρο / σε εξωτερικό χώρο
<b>Μέγιστο υψόμετρο (m)</b>	2000	2000	2000	2000	2000	2000
<b>Θερμοκρασία περιβάλλοντος</b>	-40 έως 95 °C (-40 έως 203 °F)	-40 έως 95 °C (-40 έως 203 °F)	-40 έως 95 °C (-40 έως 203 °F)	-40 έως 95 °C (-40 έως 203 °F)	-40 έως 145 °C (-40 έως 293 °F)	-40 έως 145 °C (-40 έως 293 °F)
<b>Πίεση</b>	8 bar (120 psi)	8 bar (120 psi)	Ευρώπη: 0,5 bar B. Αμερική: 15 psi	Ευρώπη: 0,5 bar B. Αμερική: 15 psi	8 bar (120 psi)	8 bar (120 psi)
<b>Βαθμός ρύπανσης</b>	4	4	4	4	4	4
<b>Κατασκευή</b>						
<b>Περιβλήμα</b>	PVDF	PVDF	PVDF	PVDF	Στάνταρ: PVDF Προαιρετικά: Φλάντζα διαστάσεων γενικής χρήσης* που διατίθεται με επιφάνεια PTFE	
<b>Τοποθέτηση</b>	Σύνδεση αγωγών 1" NPT ή BSP	Σύνδεση αγωγών 1" NPT ή BSP	Σύνδεση αγωγών 1-1/2" NPT ή BSP	Σύνδεση αγωγών 1-1/2" NPT ή BSP	Σύνδεση αγωγών 1" NPT ή BSP	Σύνδεση αγωγών 1" NPT ή BSP
<b>Επιλογές</b>	<ul style="list-style-type: none"> <li>• με εργασιασική συγκόλληση προκειμένου να ικανοποιεί τα πρότυπα ANSI, DIN και JIS</li> <li>• επιφάνεια από σφρό πολυαιθυλενίου για περιβάλλον με σκόνη ή ατμούς</li> <li>• θωράκιση εμπάτισης σε περιπτώσεις όπου μπορεί να προκληθεί υπερπλήρωση (διατίθεται μόνο στους τύπους XPS-10, XPS-15)</li> <li>• διαιρούμενη φλάντζα για επιτόπια τοποθέτηση, προκειμένου να ικανοποιεί τα πρότυπα ANSI, DIN και JIS (δεν διατίθεται στον τύπο XPS-40)</li> </ul>					
<b>Καλώδιο</b>	Δισύρματο συνεστραμμένο ζεύγος/με θωράκιση πλέγματος και μεμβράνης, 0,5 mm <sup>2</sup> (20 AWG), μανδύας PVC		<ul style="list-style-type: none"> <li>• Δισύρματο συνεστραμμένο ζεύγος/με θωράκιση πλέγματος και μεμβράνης, 0,5 mm<sup>2</sup> (20 AWG), μανδύας PVC</li> <li>• <b>Μέγιστη απόσταση διαχωρισμού:</b> 100 m (330 ft)</li> <li>• RG-62 A/U coax <b>Μέγιστη απόσταση διαχωρισμού:</b> 365 m (1200 ft)</li> </ul>		Μανδύας σιλικόνης	
<b>Βάρος**</b>	0,8 kg (1,7 lb)	1,3 kg (2,8 lb)	4,3 kg (9,5 lb)	8 kg (18 lb)	0,8 kg (1,7 lb)	1,3 kg (2,8 lb)
<b>Μέγιστη απόσταση διαχωρισμού</b>	365 m (1200 ft)	365 m (1200 ft)	365 m (1200 ft)	365 m (1200 ft)	365 m (1200 ft)	365 m (1200 ft)
<b>Πηγή τροφοδοσίας</b>	Οι μορφοτροπείς θα πρέπει να τροφοδοτούνται μόνο από ελεγκτές που έχουν πιστοποιηθεί από τη Siemens Milltronics					
<b>Εγκρίσεις</b>	CE***, CSA, FM, CENELEC/ATEX, INMETRO: Βάλτε πινακίδα ονόματος ή συμβουλευθείτε τη Siemens Milltronics για τις τρέχουσες εγκρίσεις.					

\* Η φλάντζα γενικής χρήσης ικανοποιεί τα πρότυπα ANSI, DIN και JIS.

\*\* Προσεγγιστικό βάρος αποστολής του μορφοτροπέα με σύνθεσης μήκους καλωδίου.

\*\*\* Επιδόσεις EMC κατόπιν αίτησης.

# Διάγραμμα και διαστάσεις

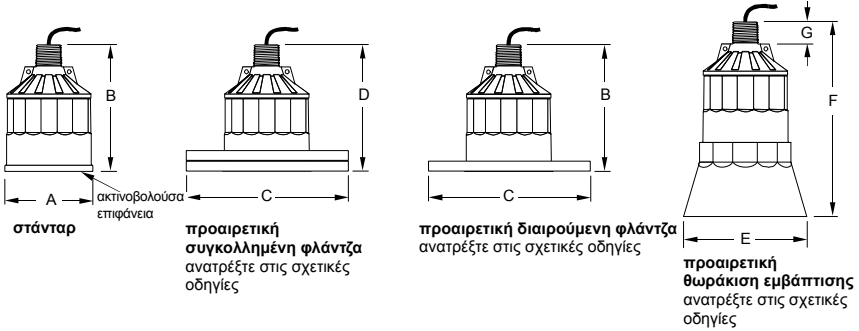

Διαστάσεις	XPS 10	XPS-15	XPS-30	XPS-40	XCT-8	XCT-12
A	88 mm (3,4")	121 mm (4,8")	175 mm (6,9")	206 mm (8,1")	88 mm (3,4")	121 mm (4,8")
B	122 mm (4,8")	132 mm (5,2")	198 mm (7,8")	229 mm (9,0")	122 mm (4,8")	132 mm (5,2")
C	για να ικανοποιούνται τα πρότυπα ANSI, DIN και JIS					
D*	128 mm (5,0")	138 mm (5,4")	204 mm (8,0")	235 mm (9,2")	128 mm (5,0")	138 mm (5,4")
E	124 mm (4,9")	158 mm (6,2")	δεν διατίθεται	δεν διατίθεται	δεν διατίθεται	δεν διατίθεται
F	152 mm (6,0")	198 mm (7,8")	δεν διατίθεται	δεν διατίθεται	δεν διατίθεται	δεν διατίθεται
G	28 mm (1,1")	28 mm (1,1")	28 mm (1,1")	28 mm (1,1")	28 mm (1,1")	28 mm (1,1")

\* ονομαστική



**ΠΡΟΕΙΔΟΠΟΙΗΣΗ:** Οι προαιρετικές διατάξεις με διαιρούμενη φλάντζα, συγκολλημένη φλάντζα και Easy Aimer (εύκολη στόχευση) δεν είναι κατάλληλες για συσκευές υπό πίεση.

## Τοποθέτηση

**ΠΡΟΕΙΔΟΠΟΙΗΣΗ:** Πρέπει να λαμβάνονται ειδικές προφυλάξεις χειρισμού, έτσι ώστε η επιφάνεια του μορφοτροπέα να προστατεύεται από ενδεχόμενη ζημία.

- Τοποθετήστε το μορφοτροπέα κατά τέτοιο τρόπο ώστε να βρίσκεται **πάνω από τη μέγιστη στάθμη υλικού τουλάχιστον κατά την τιμή "νεκρής ζώνης"**. Ανατρέξτε στο εγχειρίδιο του σχετικού ελεγκτή.
- Σε εφαρμογές υγρών τοποθετήστε την επιφάνεια του μορφοτροπέα παράλληλα με την επιφάνεια του υγρού. Σε εφαρμογές στερεών, χρησιμοποιήστε το Easy Aimer της Siemens Milltronics για να διευκολυνθεί η στόχευση του μορφοτροπέα.
- Μην σφίγγετε υπερβολικά. Στις περισσότερες εφαρμογές απαιτείται μόνο σύσφιξη των υλικών τοποθέτησης με το χέρι. Συνδέστε το μορφοτροπέα με κάποιο δομικό στοιχείο χρησιμοποιώντας μια αλυσίδα ασφαλείας, για να ασφαλίσετε την εγκατάσταση. Χρησιμοποιήστε τον προαιρετικό **αισθητήρα θερμοκρασίας** όταν χρησιμοποιείται φλαντζωτός μορφοτροπέας, όταν απαιτείται ταχεία θερμοκρασιακή απόκριση ή σε δοχεία υψηλών θερμοκρασιών.

**Σημείωση:** Στην περίπτωση πιεσοστεγανών εφαρμογών, σφίξτε τους μορφοτροπέες με το χέρι, συν ½ έως 1½ στροφή. Μπορεί να χρησιμοποιηθεί ταινία PTFE ή άλλο κατάλληλο στεγανοποιητικό μέσο για τη στεγανοποίηση των σπειρωμάτων σε συσκευές υπό πίεση.

# Τοποθέτηση – Εφαρμογές στερεών

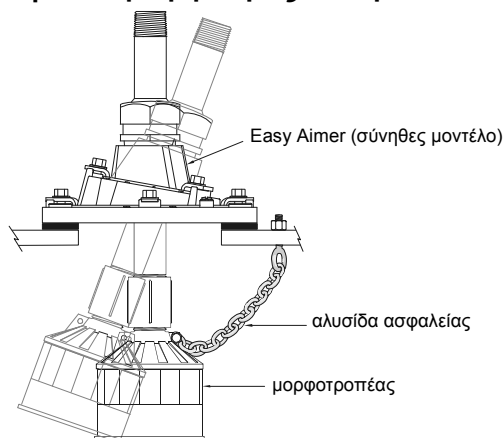

**ΠΡΟΕΙΔΟΠΟΙΗΣΗ:** Η μη ενδεδειγμένη εγκατάσταση μπορεί να έχει ως αποτέλεσμα την απώλεια της πίεσης διεργασίας.

# Τοποθέτηση – Εφαρμογές υγρών

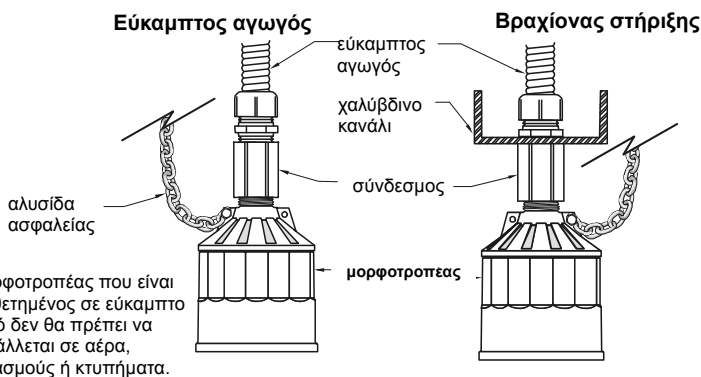

Ο μορφροτροπέας που είναι τοποθετημένος σε εύκαμπτο αγωγό δεν θα πρέπει να υποβάλλεται σε αέρα, κραδασμούς ή κτυπήματα.

## Με δυνατότητα εμβάπτισης

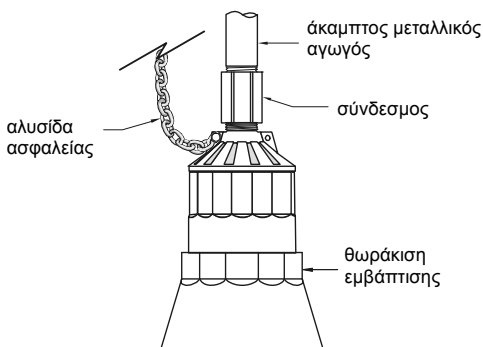

Μορφροτροπέας με θαράκιση εμβάπτισης, χρησιμοποιείται σε εφαρμογές όπου υπάρχει πιθανότητα υπερπλήρωσης.

## Κόντρα πλακέ

Η τοποθέτηση σε κόντρα πλακέ παρέχει άριστη μόνωση, πρέπει όμως να είναι επαρκώς άκαμπτη, ώστε να αποφευχθεί ενδεχόμενη κάμψη σε περίπτωση που υποβληθεί σε φορτίο.

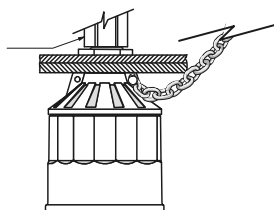

# Τοποθέτηση – Εφαρμογές υγρών (συνέχεια)

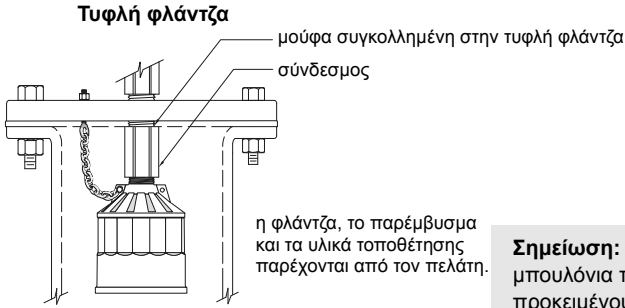

**Σημείωση:** Σφίξτε ομοιόμορφα τα μπουλόνια της φλάντζας, προκειμένου να διασφαλιστεί η σωστή στεγανοποίηση μεταξύ των φλαντζών εφαρμογής.

**Προσοχή:** Το υπερβολικό σφίξιμο μπορεί να προκαλέσει μείωση των επιδόσεων.

## Φλαντζωτού τύπου

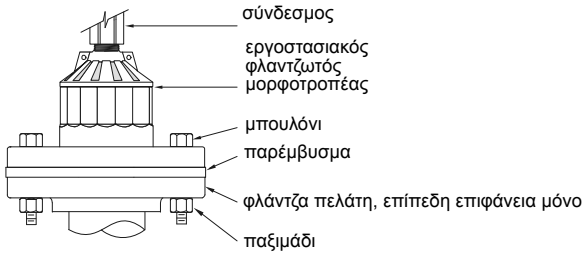

Φλαντζωτός κατακόρυφος σωλήνας πελάτη. Αν πρέπει να συγκολληθεί μεταλλική φλάντζα στο σωλήνα, ανατρέξτε στις Εφαρμογές υγρών – Κατακόρυφοι σωλήνες στο *Εγχειρίδιο εφαρμογών μορφοτροπέων*.

# Εγκατάσταση

**Σημείωση:** Η εγκατάσταση πρέπει να πραγματοποιείται από εξειδικευμένο προσωπικό και σύμφωνα με τους κατά τόπους ισχύοντες κανονισμούς.

- Μην αφήνετε το καλώδιο ακάλυπτο. Για μέγιστη μόνωση από ηλεκτρικούς θορύβους, τοποθετήστε το καλώδιο ξεχωριστά, μέσα σε γειωμένο μεταλλικό αγωγό. Στεγανοποιήστε όλες τις σπειροτομημένες συνδέσεις για να αποφευχθεί η διείσδυση υγρασίας.
- Μην τοποθετείτε το καλώδιο κοντά σε υψηλές τάσεις ή ρεύματα, ασφαλειοδιακόπτες και οδηγούς ελέγχου SCR. Στην περίπτωση πιεσοστεγανών εφαρμογών, σφίξτε τους μορφοτροπείς με το χέρι, συν ½ έως 1½ στροφή.
- Μπορεί να χρησιμοποιηθεί ταινία PTFE ή άλλο κατάλληλο στεγανοποιητικό μέσο για τη στεγανοποίηση των σπειρωμάτων σε συσκευές υπό πίεση.



**ΠΡΟΕΙΔΟΠΟΙΗΣΗ:** Μην επιχειρήσετε να χαλαρώσετε, να αφαιρέσετε ή να αποσυναρμολογήσετε το συνδετήρα διεργασίας, ενώ τα περιεχόμενα του δοχείου βρίσκονται υπό πίεση.



# Διασύνδεση

## Απευθείας σύνδεση

Συνδέστε το μορφοτροπέα απευθείας με τον πομποδέκτη Siemens Milltronics χρησιμοποιώντας το δισύρματο θωρακισμένο καλώδιο.

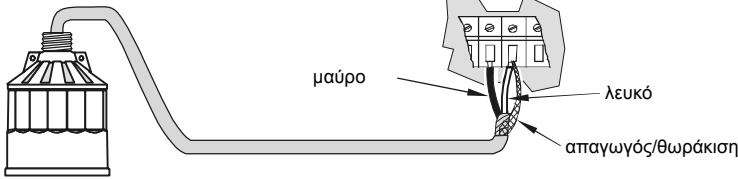

**Σημείωση:** Κατά τη σύνδεση σε SITRANS LUT400, SITRANS LUC500, MultiRanger 100/200 ή HydroRanger 200, το λευκό, το μαύρο και το θωρακισμένο σύρμα συνδέονται ξεχωριστά. ΜΗΝ συνδέετε το λευκό με το θωρακισμένο σύρμα.

## Ομοαξονική σύνδεση

Συνδέστε το μορφοτροπέα με πομποδέκτη Siemens Milltronics χρησιμοποιώντας ένα κουτί διακλάδωσης και το ομοαξονικό καλώδιο RG-62 A/U. Η διάταξη αυτή είναι κατάλληλη για συνδυαστικές περιπτώσεις έως 365 m (1200 ft).

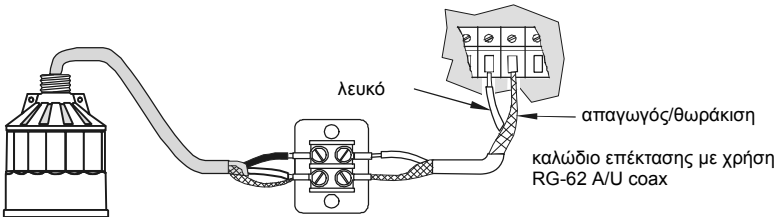

**Σημείωση:** Κατά τη σύνδεση με SITRANS LUT400, SITRANS LUC500, MultiRanger 100/200 και HydroRanger 200, ΜΗΝ χρησιμοποιείτε ομοαξονικό καλώδιο, αλλά ανατρέξτε στο παρακάτω διάγραμμα για τη σωστή διαδικασία.

## Δισύρματη επέκταση

(για SITRANS LUT400, SITRANS LUC500, MultiRanger 100/200 και HydroRanger 200 μόνο)

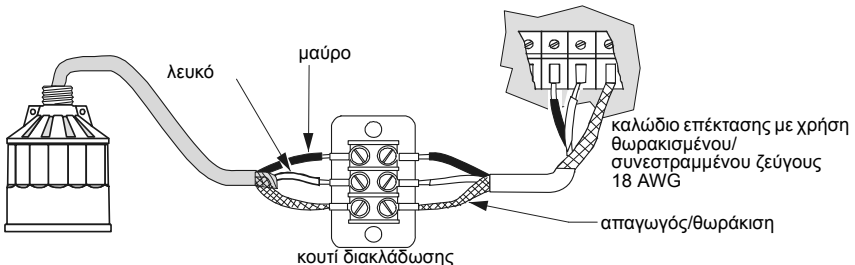



# Manual de operación Echomax XPS/XCT

Este manual describe las principales características y funciones de los sensores Echomax XPS/XCT. Este manual y la *Guía de aplicación de los transductores* están disponibles en: [www.siemens.com/processautomation](http://www.siemens.com/processautomation). Para obtener copias impresas contacte con un representante Siemens Milltronics.

Para más informaciones acerca de este manual contacte:

Siemens Milltronics Process Instruments  
1954 Technology Drive, P.O. Box 4225  
Peterborough, Ontario, Canada, K9J 7B1  
Email: [techpubs.smpi@siemens.com](mailto:techpubs.smpi@siemens.com)

**Representante europeo autorizado**

Siemens AG  
Industry Sector  
76181 Karlsruhe  
Deutschland

**Copyright Siemens Milltronics  
Process Instruments 2013.  
Todos los derechos reservados**

**Exención de responsabilidad**

Recomendamos a nuestros usuarios obtengan copias impresas de la documentación o consulten las versiones digitales diseñadas y comprobadas por Siemens Milltronics Process Instruments.. En ningún caso será Siemens Milltronics Process Instruments responsable de reproducciones totales o parciales de la documentación, ya sea de versiones impresas o electrónicas.

Nosotros hacemos todo lo necesario para garantizar la conformidad del contenido de este manual con el equipo proporcionado. Sin embargo, estas informaciones quedan sujetas a cambios. SMPI no asume responsabilidad alguna por omisiones o diferencias. Examinamos y corregimos el contenido de este manual regularmente y nos esforzamos en proporcionar publicaciones cada vez más completas. No dude en contactarnos si tiene preguntas o comentarios. Las especificaciones están sujetas a cambios.

MILLTRONICS es una marca registrada de Siemens Milltronics Process Instruments

## Indicaciones de seguridad

Es imprescindible respetar las indicaciones de seguridad para una utilización sin peligro alguno para el usuario, el personal, el producto y los equipos conectados a éste. Por motivos de claridad expositiva en los textos de indicación y de precaución se destaca el nivel de precaución necesario para cada intervención.



**ADVERTENCIA:** información que se refiere a un marcado colocado en el producto. Significa que al no observar las precauciones de seguridad se puede producir la muerte, lesiones corporales graves y/o daños materiales considerables.



**ADVERTENCIA:** significa que al no observar las precauciones de seguridad se puede producir la muerte, lesiones corporales graves y/o daños materiales considerables.

**PRECAUCIÓN:** significa que al no observar las precauciones de seguridad se pueden producir daños materiales considerables.

**Nota:** es una información importante acerca del producto mismo o de la parte respectiva del manual, al cual se debe atender especialmente.

## Reparaciones y límite de responsabilidad

- El usuario es el único responsable de las modificaciones y reparaciones en el dispositivo efectuadas por él mismo o por su agente.
- Recomendamos utilizar sólo recambios originales Siemens Milltronics Process Instruments Inc.
- Reparar sólo los componentes defectuosos.
- No reutilizar los componentes defectuosos.

# Introducción

**Este aparato se ha diseñado para el uso en ámbito industrial. El uso de este aparato en instalaciones residenciales puede causar interferencias a las comunicaciones por radio.**

Los sensores ultrasónicos Echomax XPS/XCT se utilizan con los controladores, o transmisores de nivel Siemens Milltronics.

El sensor convierte la energía eléctrica de la pulsación emitida por el emisor receptor en energía acústica, y convierte la energía acústica del eco de retorno en energía eléctrica, para el transmisor.

La energía acústica efectiva se genera en la cara del sensor y es radiada hacia afuera, disminuyendo en amplitud con un cociente inversamente proporcional al cuadrado de la distancia. La potencia máxima es irradiada axialmente (perpendicular) de la cara del sensor en una línea que se conoce como el eje de transmisión. Cuando la potencia se reduce a la mitad (-3 dB) se forma un límite cónico que define el haz sonoro. La medida de diámetro de éste cono en grados se define como el ángulo de emisión.

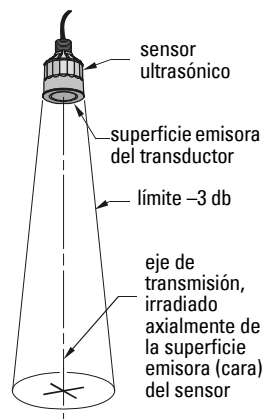

Los sensores XPS/XCT incorporan un sensor de temperatura, que informa al transmisor de la temperatura del aire en el sensor ultrasónico.

## Indicaciones generales



**ADVERTENCIA:** Los materiales de construcción son seleccionados en base a su compatibilidad química (o inertidad) para usos generales. Antes de instalar los sensores en ambientes específicos recomendamos consulte las tablas de compatibilidad química.

### Serie XPS/XCT – Certificado SIRA 99ATEX5153X

Estos sensores están diseñados para su utilización en zonas peligrosas con gas y temperatura (Serie XPS : Clase T1, T2, T3 y T4 (XPS-10, XPS-15, XPS-30, XPS-40) y Serie XCT T1, T2, y T3 (XCT-8, XCT-12). Los sensores XPS sólo deberán utilizarse en temperaturas ambientes de -40 °C a 95 °C, y los sensores XCT en temperaturas ambientes de -40 °C a 145 °C. Es imprescindible respetar los rangos de temperatura especificados.

La instalación deberá efectuarse por un personal calificado, respetando las recomendaciones locales en vigor.

Estos sensores deberán recibir alimentación eléctrica de sistemas con un fusible apropiado, con una capacidad de ruptura de 4000A. Los transmisores Siemens Milltronics incorporan este tipo de fusible.

Las reparaciones deberán efectuarse respetando los códigos de práctica aplicables.

La certificación de estos sensores se basa en la utilización de los siguientes materiales de construcción:

	Serie XPS	Serie XCT
Caja	Kynar® 1710	Kynar® 710
Encapsulante	Stycast LA-9823-76	Durapot® 861-F3 & 864

1. Kynar® es una marca registrada de ELF Atochem.  
Durapot® es una marca registrada de Cotronics Corporation.

El sobremando manual se obtiene con el corta circuitos en la instalación del transmisor conectado al sensor ultrasónico.

### Serie XPS 30/40 – Certificado SIRA 01ATEX5153X

Estos sensores están diseñados para su utilización en zonas peligrosas con polvos conductores o no conductores. La temperatura en la superficie de los sensores XPS-30 y XPS-40 no deberá superar los 135 °C (275 °F) (Clase de temperatura T4). Estos sensores sólo deberán utilizarse en temperaturas ambientes de -40 a 95 °C (-40 a 203 °F). Es imprescindible no exponer los sensores a temperaturas superiores o inferiores al rango especificado. No instalar los sensores ultrasónicos XPS-30 y XPS-40 en lugares donde su superficie emisora (cara) esté expuesta a demasiada luz.

La instalación deberá efectuarse por un personal calificado, respetando las recomendaciones locales en vigor. Las reparaciones deberán efectuarse respetando los códigos de práctica aplicables y las instrucciones de instalación.

Estos sensores deberán recibir alimentación eléctrica de sistemas con un fusible apropiado, con una capacidad de ruptura de 4000A. Los transmisores Siemens Milltronics incorporan este tipo de fusible.

La certificación de estos sensores se basa en la utilización de los siguientes materiales de construcción:

Caja:	Kynar® 710
Encapsulante:	Stycast LA-9823-76

El sobremando manual se obtiene con el corta circuitos en la instalación del transmisor conectado al sensor ultrasónico.

## Marcado de los productos



**Nota:** El Kynar® (fluoruro de polivinilideno) es inmune a la mayoría de sustancias químicas, en condiciones de funcionamiento normales. Antes de instalar los sensores en ambientes específicos recomendamos consulte las tablas de compatibilidad química.

**ADVERTENCIA:** De acuerdo con la Directiva 97/23/CE, estos sensores se definen equipos a presión y ***no están diseñados*** para ser utilizados como aparatos de seguridad.





## XCT-8

SIEMENS	
XCT-8 ULTRASONIC TRANSDUCER Serial No: GYZ / A1034567 Ambient Temp.: -40 °C to 145 °C V in: 1.77 V r.m.s.; 250 Vp I in: 44.2 mA r.m.s.	CE 0518 II 2 GD EEx m II T3 SIRA 99ATEX5153X KCC-REM-549 Echomax
Enclosure: IP66, IP68	ATENÇÃO - RISCO POTENCIAL DE CARGA ELETROSTÁTICA - VEJA INSTRUÇÕES
Siemens Milltronics Process Instruments, Peterborough	

Segurança	
 Ex mb IIC T3 Gb Ex tb IIIC T135 °C Db DNV 12.0077 X	Class I, Zone 1, Ex s I T4, Amb. Temp.: -40°C to 95°C Ex s IIC T3, Amb. Temp.: -40°C to 145°C DIP IP65 / IP67 ANZEx 08.3066X <b>WARNING:</b> Static Hazard, Do Not Rub With Dry Cloth.
	Class I, Div 2, Group A, B, C, D Class II, Div 2, Group F, G Per Dwg.: 0-9650017Z-DI-A Max. Torque: 15 FT-LBS

## XCT-12

SIEMENS	
XCT-12 ULTRASONIC TRANSDUCER Serial No: GYZ / A1034567 Ambient Temp.: -40 °C to 145 °C V in: 1.77 V r.m.s.; 250 Vp I in: 44.2 mA r.m.s.	CE 0518 II 2 GD EEx m II T3 SIRA 99ATEX5153X KCC-REM-549 Echomax
Enclosure: IP66, IP68	ATENÇÃO - RISCO POTENCIAL DE CARGA ELETROSTÁTICA - VEJA INSTRUÇÕES
Siemens Milltronics Process Instruments, Peterborough	



Segurança	
 Ex mb IIC T3 Gb Ex tb IIIC T135 °C Db DNV 12.0077 X	Class I, Zone 1 Ex s I T4, Amb. Temp.: -40°C to 95°C Ex s IIC T3, Amb. Temp.: -40°C to 145°C DIP IP65 / IP67 ANZEx 08.3066X <b>WARNING:</b> Static Hazard, Do Not Rub With Dry Cloth.
	Class I, Div 2, Group A, B, C, D Class II, Div 2, Group F, G Per Dwg.: 0-9650017Z-DI-A Max. Torque: 15 FT-LBS
ATENÇÃO - RISCO POTENCIAL DE CARGA ELETROSTÁTICA - VEJA INSTRUÇÕES	

### Nota:

- Los números de configuración sólo se proporcionan a título orientativo.
- Los números de serie sólo se proporcionan a título orientativo.

## XPS-10



SIEMENS	
<b>XPS-10 ULTRASONIC TRANSDUCER</b> Serial No: GYZ / A1034567 Ambient Temp.: - 40 °C to 95 °C V in : 1.77 V r.m.s.; 250 Vp I in : 44.2 mA r.m.s.	 II 2 GD EEx m II T4 SIRA 99ATEX5153X Class I, Zone 1, Ex s IIIC T4 DIP IP65 / 67 ANZEx 08.3066X
Enclosure: IP66, IP68 Siemens Milltronics Process Instruments, Peterborough	

   
0518  
  
KCC-REM-S49  
Echomax

 APPROVED Class I, Div 2, Group A, B, C, D Class II, Div 1, Group E, F, G Per Dwg.: 0-96500172-DI-A Max. Torque: 15 FT-LBS	<b>WARNING:</b> Static Hazard, Do Not Rub With Dry Cloth.	<b>Segurança</b>  INMETRO Ex mb IIC T4 Gb Ex tb IIIC T135 °C Db DNV 12.0077 X
ATENÇÃO - RISCO POTENCIAL DE CARGA ELETROSTÁTICA - VEJA INSTRUÇÕES		

## XPS-15

SIEMENS	
<b>XPS-15 ULTRASONIC TRANSDUCER</b> Serial No: GYZ / A1034567 Ambient Temp.: - 40°C to 95°C V in : 1.77 V r.m.s.; 250 Vp I in : 44.2 mA r.m.s.	 II 2 GD EEx m II T4 SIRA 99ATEX5153X Class I, Zone 1, Ex s IIIC T4 DIP IP65 / 67 ANZEx 08.3066X
Enclosure: IP66, IP68 Siemens Milltronics Process Instruments, Peterborough	

 KCC-REM-S49  
Echomax  
 0518  

<b>Segurança</b>  INMETRO Ex mb IIC T4 Gb Ex tb IIIC T135 °C Db DNV 12.0077 X	 APPROVED Class I, Div 2, Group A, B, C, D Class II, Div 1, Group E, F, G Per Dwg.: 0-96500172-DI-A Max. Torque: 15 FT-LBS	<b>WARNING:</b> Static Hazard, Do Not Rub With Dry Cloth. ATENÇÃO - RISCO POTENCIAL DE CARGA ELETROSTÁTICA - VEJA INSTRUÇÕES
---	--	---



### Nota:

- Los números de configuración sólo se proporcionan a título orientativo.
- Los números de serie sólo se proporcionan a título orientativo.





## XPS-30

SIEMENS	
<b>XPS-30 ULTRASONIC TRANSDUCER</b> Serial No: GYZ / A1034567 Ambient Temp.: - 40 °C to 95 °C V in: 1.77 V r.m.s.; 250 Vp I in: 44.2 mA r.m.s. Enclosure: IP66, IP68 Siemens Milltronics Process Instruments, Peterborough	   Class I, Zone 1, Ex s IIIC T4 DIP IP65 / 67 ANZEx 08.3066X

Segurança	
 Ex mb IIC T4 Gb Ex tb IIIC T135 °C Db DNV 12.0077 X	 Class I, Div 2, Group A, B, C, D Class II, Div 1, Group E, F, G Per Dwg.: 0-9650017Z-DI-A Max. Torque: 15 FT-LBS (20 N-m) <b>WARNING:</b> Static Hazard, Do Not Rub With Dry Cloth. ATENÇÃO - RISCO POTENCIAL DE CARGA ELETROSTÁTICA - VEJA INSTRUÇÕES

## XPS-40

SIEMENS	
<b>XPS-40 ULTRASONIC TRANSDUCER</b> Serial No: GYZ / A1034567 Ambient Temp.: - 40 °C to 95 °C V in: 1.77 V r.m.s.; 250 Vp I in: 44.2 mA r.m.s. Enclosure: IP66, IP68 Siemens Milltronics Process Instruments, Peterborough	   Class I, Zone 1, Ex s IIIC T4 DIP IP65 / 67 ANZEx 08.3066X

Segurança	
 Ex mb IIC T4 Gb Ex tb IIIC T135 °C Db DNV 12.0077 X	 Class I, Div 2, Group A, B, C, D Class II, Div 1, Group E, F, G Per Dwg.: 0-9650017Z-DI-A Max. Torque: 15 FT-LBS (20 N-m) <b>WARNING:</b> Static Hazard, Do Not Rub With Dry Cloth. ATENÇÃO - RISCO POTENCIAL DE CARGA ELETROSTÁTICA - VEJA INSTRUÇÕES

### Nota:

- Los números de configuración sólo se proporcionan a título orientativo.
- Los números de serie sólo se proporcionan a título orientativo.

# Especificaciones

	XPS-10	XPS-15	XPS-30	XPS-40	XCT-8	XCT-12
Rango de medida	0,3 - 10 m (1 - 33 ft)	0,3 - 15 m (1 - 50 ft)	0,6 - 30 m (2 - 100 ft)	0,9 - 40 m (3 - 130 ft)	0,6 - 8 m (2 - 26 ft)	0,6 - 12 m (2 - 40 ft)
Frecuencia (kHz)	44	44	30	22	44	44
Ángulo de haz	12°	6°	6°	6°	12°	6°
<b>Condiciones ambientales</b>						
Ubicación	montaje interior / a prueba de intemperie	montaje interior / a prueba de intemperie	montaje interior / a prueba de intemperie	montaje interior / a prueba de intemperie	montaje interior / a prueba de intemperie	montaje interior / a prueba de intemperie
Máxima altitud (m)	2000	2000	2000	2000	2000	2000
Temperatura ambiente	-40 a 95 °C (-40 a 203 °F)	-40 a 95 °C (-40 a 203 °F)	-40 a 95 °C (-40 a 203 °F)	-40 a 95 °C (-40 a 203 °F)	-40 a 145 °C (-40 a 293 °F)	-40 a 145 °C (-40 a 293 °F)
Presión	8 bar (120 psi)	8 bar (120 psi)	Europa: 0,5 bar Norteamérica: 15 psi	Europa: 0,5 bar Norteamérica: 15 psi	8 bar (120 psi)	8 bar (120 psi)
Grado de contaminación	4	4	4	4	4	4
<b>Construcción</b>						
Caja	PVDF	PVDF	PVDF	PVDF	<b>Estándar:</b> PVDF <b>Opcional:</b> Brida universal* con revestimiento PTFE	
Montaje	Entrada de conductos 1" NPT o BSP	Entrada de conductos 1" NPT o BSP	Entrada de conductos 1-1/2" NPT o BSP	Entrada de conductos 1-1/2" NPT o BSP	Entrada de conductos 1" NPT o BSP	Entrada de conductos 1" NPT o BSP
Opciones	<ul style="list-style-type: none"> <li>unidas en fábrica en conformidad con los estándares ANSI, DIN y JIS</li> <li>revestimiento de espuma de polietileno para ambientes con polvo o vapor</li> <li>vaina anti inundación para aplicaciones con riesgo de inmersión (sólo para sensores XPS-10 y XPS-15)</li> <li>brida partida para montaje en campo, estándar ANSI, DIN y JIS (no disponible con el sensor XPS-40)</li> </ul>					
Cable	2 conductores, par trenzado apantallado, blindaje metálico, 0.5mm2 (20 AWG), cubierta de PVC		<ul style="list-style-type: none"> <li>2 conductores, par trenzado apantallado, blindaje metálico, 0.5mm2 (20 AWG), cubierta de PVC</li> <li><b>Máxima separación:</b> 100 m (330 ft)</li> <li>Coaxial RG-62 A/U <b>Máxima separación:</b> 365 m (1200 ft)</li> </ul>		Cubierta de silicio	
Peso**	0,8 kg (1,7 lb)	1,3 kg (2,8 lb)	4,3 kg (9,5 lb)	8 kg (18 lb)	0,8 kg (1,7 lb)	1,3 kg (2,8 lb)
Máxima separación	365 m (1200 ft)	365 m (1200 ft)	365 m (1200 ft)	365 m (1200 ft)	365 m (1200 ft)	365 m (1200 ft)
Alimentación eléctrica	Los sensores sólo pueden funcionar conectados a los transmisores Siemens Milltronics					
Certificaciones	CE***, CSA, FM, CENELEC/ATEX, INMETRO: Vea la placa indicadora en el producto o contacte con Siemens Milltronics para obtener una lista actualizada.					

\* Brida universal, estándar ANSI, DIN y JIS.

\*\* Peso de transporte aproximado del sensor con cable, longitud estándar.

\*\*\* Certificado relativo a CEM disponible bajo demanda.

# Esquema de dimensiones

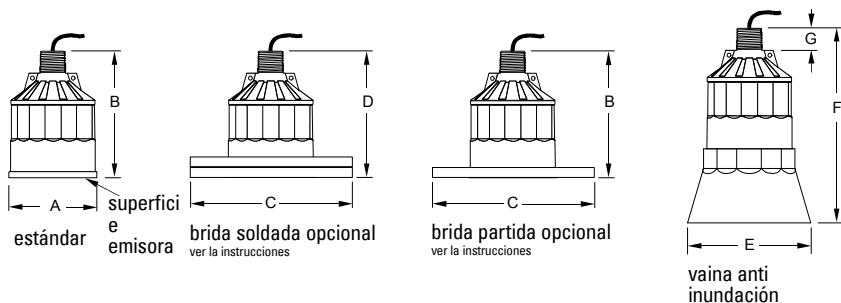

Dimensión	XPS-10	XPS-15	XPS-30	XPS-40	XCT-8	XCT-12
A	88 mm (3,4")	121 mm (4,8")	175 mm (6,9")	206 mm (8,1")	88 mm (3,4")	121 mm (4,8")
B	122 mm (4,8")	132 mm (5,2")	198 mm (7,8")	229 mm (9,0")	122 mm (4,8")	132 mm (5,2")
C	conformes con los estándares ANSI, DIN y JIS					
D*	128 mm (5,0")	138 mm (5,4")	204 mm (8,0")	235 mm (9,2")	128 mm (5,0")	138 mm (5,4")
E	124 mm (4,9")	158 mm (6,2")	n/a	n/a	n/a	n/a
F	152 mm (6,0")	198 mm (7,8")	n/a	n/a	n/a	n/a
G	28 mm (1,1")	28 mm (1,1")	28 mm (1,1")	28 mm (1,1")	28 mm (1,1")	28 mm (1,1")

\* nominal



**ADVERTENCIA:** Las bridas partidas opcionales, las bridas soldadas, y el Kit Easy Aimer **NO** están diseñados para aplicaciones con presión.

# Montaje

**ATENCIÓN:** El usuario deberá proteger adecuadamente la superficie emisora del sensor durante la manipulación.

- Instalar el sensor a una distancia **por lo menos equivalente a la zona muerta, por encima del nivel más alto de material**. Véase el manual de instrucciones del controlador/transmisor.
- En aplicaciones con líquidos instalar el sensor para que el eje de transmisión sea perpendicular a la superficie del líquido. En aplicaciones con sólidos, se recomienda la brida de fijación Easy Aimer Siemens Milltronics para facilitar la orientación del sensor.
- No apretar excesivamente el sensor durante el montaje. En la mayoría de las aplicaciones basta con apretar el material manualmente. Instalar una cadena de seguridad entre el sensor y la estructura fija (base de instalación) para proteger el sistema. Al utilizar un sensor ultrasónico con brida se recomienda tener en cuenta la posibilidad de utilizar el **sensor de temperatura opcional**. Este sensor se utiliza también para obtener mediciones rápidas de la temperatura, o bajo temperaturas elevadas.

**Nota:** Bajo condiciones de vacío (presión), apretar los sensores manualmente más ½ vuelta (ó 1½). Utilizar cinta de PTFE o cualquier otro sellador para asegurar una unión hermética de las roscas en aplicaciones bajo presión.

## Montaje - Aplicaciones con sólidos

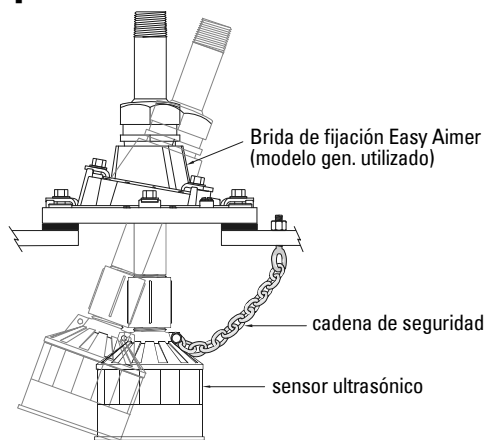

**ADVERTENCIA:** La instalación incorrecta puede provocar una caída de presión del proceso.

# Montaje - Aplicaciones con líquidos

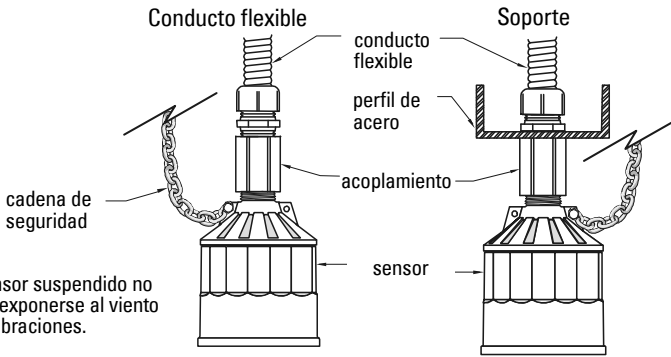

El sensor suspendido no debe exponerse al viento ni a vibraciones.

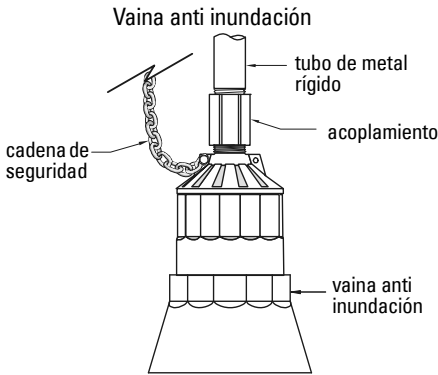

El sensor con vaina anti inundación se utiliza en aplicaciones con riesgo de inmersión.

## Madera contrachapada

El soporte de madera contrachapada ofrece un excelente aislamiento (debe ser rígido).

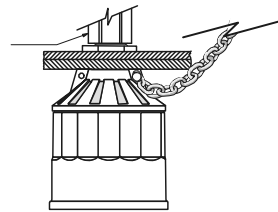

# Montaje – Aplicaciones con líquidos (continuación)

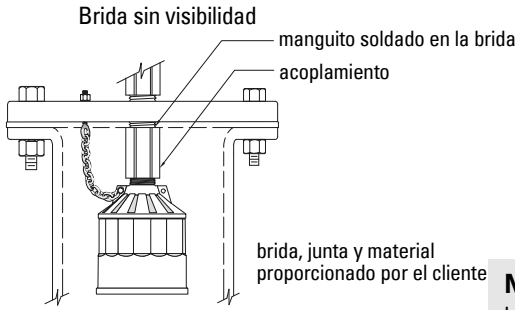

**Nota:** Apretar los tornillos de la brida uniformemente para garantizar una junta hermética entre las bridas.

**Precaución:** Para mayor rendimiento evitar apretar excesivamente.

## Montaje con brida

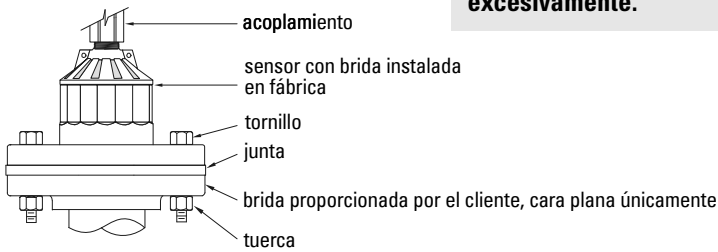

Tubo vertical con brida proporcionado por el cliente. Para soldar una brida metálica en el tubo consulte la sección Aplicaciones con líquidos - Tubos verticales en la *Guía de aplicación de los sensores*.

# Instalación

**Nota:** Sólo el personal calificado está autorizado a intervenir en este equipo para la instalación. Observar las indicaciones y los procedimientos de seguridad.

- Instalar protecciones adecuadas para los cables. Instalar los cables separadamente en tuberías metálicas conectadas a tierra, para tener mayor inmunidad al ruido ambiental. Sellar todas las conexiones herméticamente para evitar infiltración y humedad.
- Evitar la instalación del cable cerca de fuentes de alta tensión o alta intensidad, contactores y sistemas de control, SCR. Bajo condiciones de vacío (presión), apretar los sensores manualmente más  $\frac{1}{2}$  vuelta (ó  $1\frac{1}{2}$ ).
- Utilizar cinta de PTFE o cualquier otro sellador para asegurar una unión hermética de las roscas en aplicaciones bajo presión.



**ADVERTENCIA:** Es imprescindible no destornillar, retirar o desmontar la conexión al proceso mientras el contenido del tanque esté bajo presión.

# Interconexiones

## Conexión directa

Utilizar un cable de 2 conductores blindado para conectar el sensor al transmisor Siemens Milltronics directamente.

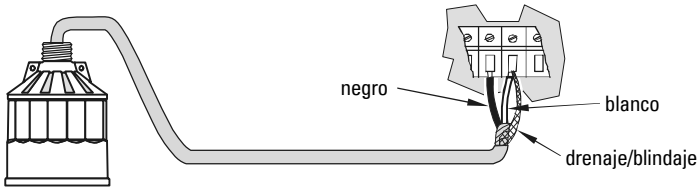

**Nota:** Para conectar el sensor y un transmisor SITRANS LUT400, SITRANS LUC500, MultiRanger 100/200, o HydroRanger 200 conectar el cable blanco, negro y el blindaje separadamente. Es imprescindible NO conectar el cable blanco y el blindaje juntos.

## Conexión coaxial

Utilizar una caja de conexiones y un cable coaxial RG-62 A/U para conectar el sensor y un transmisor Siemens Milltronics. Con este tipo de instalación se admiten separaciones de hasta 365 m (1200 ft).

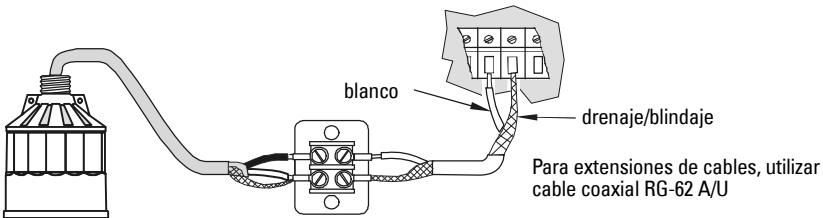

**Nota:** Es imprescindible NO utilizar cable coaxial para conectar el sensor y un transmisor SITRANS LUT400, SITRANS LUC500, MultiRanger 100/200, y HydroRanger 200. Para más detalles véase el diagrama a continuación.

## Extensión 2 hilos

(sólo para transmisores SITRANS LUT400, SITRANS LUC500, MultiRanger 100/200 y HydroRanger)

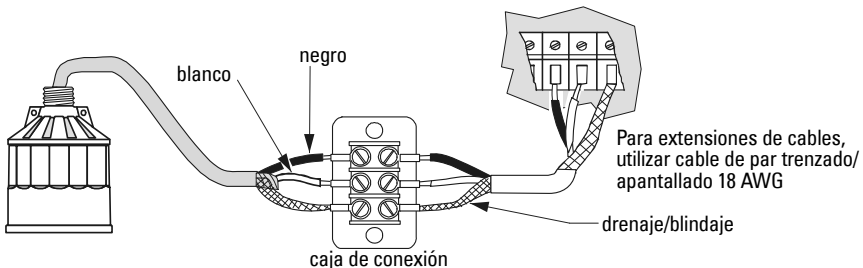





# Manuel d'utilisation Echomax XPS/XCT

Ce manuel décrit les caractéristiques et les fonctions essentielles des transducteurs Echomax XPS/XCT. Vous pouvez télécharger ce manuel, ainsi que le *Guide d'application des transducteurs* à partir du : [www.siemens.com/processautomation](http://www.siemens.com/processautomation). Pour obtenir une version imprimée du manuel, contactez votre représentant Siemens Milltronics.

## Les questions sur le contenu de ce document peuvent être adressées à:

Siemens Milltronics Process Instruments  
1954 Technology Drive, P.O. Box 4225  
Peterborough, Ontario, Canada, K9J 7B1  
Email: [techpubs.smpi@siemens.com](mailto:techpubs.smpi@siemens.com)

## Représentant européen agréé

Siemens AG  
Industry Sector  
76181 Karlsruhe  
Deutschland

**Copyright Siemens Milltronics Process Instruments 2013.  
Tous droits réservés**

### Clause de non-responsabilité

Nous encourageons les utilisateurs à se procurer les exemplaires imprimés de ces manuels ou les versions électroniques préparées et validées par Siemens Milltronics Process Instruments. Siemens Milltronics Process Instruments ne pourra être tenu responsable du contenu de toute reproduction totale ou partielle des versions imprimées ou électroniques.

Les informations fournies dans ce manuel ont été vérifiées pour garantir la conformité avec les caractéristiques du système. Des divergences étant possibles, nous ne pouvons en aucun cas garantir la conformité totale. Ce document est révisé et actualisé régulièrement pour inclure toute nouvelle caractéristique. N'hésitez pas à nous faire part de vos commentaires.  
Nous réserve de modifications techniques.

MILLTRONICS est une marque déposée de Siemens Milltronics Process Instruments

## Consignes de sécurité

Il est important de respecter les consignes fournies dans ce manuel d'utilisation pour garantir la sécurité de l'utilisateur et de tiers, ainsi que protéger le système ou tout équipement connecté à ce dernier. Chaque avertissement s'associe à une explication détaillée du niveau de précaution recommandé pour chaque opération.



**AVERTISSEMENT** : fait référence à une mention sur le produit. Signifie que la mort, des blessures corporelles graves et/ou des dommages matériels conséquents peuvent se produire si les dispositions de sécurité correspondantes ne sont pas respectées.



**AVERTISSEMENT** : signifie que la mort, des blessures corporelles graves et/ou des dommages matériels conséquents peuvent se produire si les dispositions de sécurité correspondantes ne sont pas respectées.

**PRECAUTION** : signifie que des dommages matériels conséquents peuvent se produire si les dispositions de sécurité correspondantes ne sont pas respectées.

**Note** : information importante concernant le produit ou une section particulière de la notice d'utilisation.

## Réparation de l'unité et limite de responsabilité

- Toute modification ou réparation du système effectuée par l'utilisateur ou par son mandataire sera placée sous la responsabilité de l'utilisateur.
- Utiliser seulement des composants fournis par Siemens Milltronics Process Instruments Inc.
- Réparer uniquement les composants défectueux.
- Les composants défectueux ne doivent pas être réutilisés.

# Introduction

**Cet instrument est conçu pour une utilisation en milieu industriel. Utilisé en zone résidentielle, cet appareil peut provoquer des perturbations des communications radio.**

Les transducteurs Echomax XPS/XCT sont reliés aux transmetteurs de niveau ultrasoniques de Siemens Milltronics.

Le transducteur convertit l'énergie acoustique de l'impulsion transmise, reçue du transmetteur, en énergie acoustique. L'énergie acoustique de l'écho est ensuite convertie en énergie électrique pour le transmetteur.

L'énergie acoustique est émise de la face émettrice du transducteur et rayonnée vers l'extérieur. Son amplitude est décroissante à un taux inversement proportionnel au carré de la distance. La puissance maximale est obtenue sur l'axe de transmission, ligne perpendiculaire à la face émettrice du transducteur. Le cône virtuel, centré sur l'axe de transmission, et dont l'enveloppe passe par le point où la puissance acoustique est réduite de moitié (-3 dB), définit l'angle du faisceau d'émission.

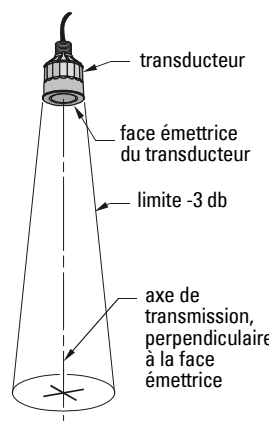

Les transducteurs XPS/XCT sont équipés d'un capteur de température interne. Ce capteur mesure la température de l'air au transducteur pour la rapporter au transmetteur.

## Consignes Générales



**AVERTISSEMENT** : Ce système est conçu avec des matériaux choisis en fonction de leur compatibilité chimique, pour une exploitation générale. Se reporter aux tableaux de compatibilité avant toute utilisation dans un environnement spécifique.

### Série XPS/XCT – Certificat SIRA 99ATEX5153X

Ces transducteurs peuvent être utilisés en zone dangereuse en présence de gaz, classification de température T1, T2, T3 et T4 pour la Série XPS (XPS-10, XPS-15, XPS-30 et XPS-40) et T1, T2 et T3 pour la Série XCT (XCT-8 et XCT-12). Les transducteurs de la Série XPS peuvent être utilisés si la température ambiante varie entre -40 °C et 95 °C. La Série XCT peut être utilisée si la température ambiante varie entre -40 °C et 145 °C. Il est important de ne pas exposer les transducteurs à des températures autres que celles indiquées pour chaque modèle.

L'installation doit être effectuée par un personnel qualifié, en accord avec les dispositions locales en vigueur.

Ces systèmes doivent être alimentés par un système comportant un fusible approprié, avec un pouvoir de coupure de 4000A. Les contrôleurs de niveau Siemens Milltronics sont livrés avec ce type de fusible.

Toute réparation du matériel devra être effectuée en accord avec les dispositions locales en vigueur.

Ce système est conçu avec les matériaux suivants, nécessaires pour l'obtention de la certification :

	Série XPS	Série XCT
Boîtier	Kynar® 710	Kynar® 710
Protection isolante	Stycast LA-9823-76	Durapot® 861-F3 & 864

1. Kynar® est une marque déposée de ELF Atochem.  
Durapot® est une marque déposée de Cotronics Corporation.

Utiliser le coupe-circuit prévu dans l'installation du transmetteur associé au transducteur pour déclencher une coupure manuellement.

### Série XPS 30/40 – Certificat SIRA 01ATEX5153X

Ces transducteurs peuvent être utilisés en atmosphère poussiéreuse, avec des poussières conductrices ou non conductrices. La température de surface des modèles XPS-30 et XPS-40 ne doit pas dépasser 135 °C (275 °F) (classification de température T4). Ces transducteurs peuvent supporter une température ambiante de -40 à 95 °C (-40 à 203 °F). Il est impératif de ne pas exposer les transducteurs à des températures autres que celles indiquées pour chaque modèle. Lors de l'installation des transducteurs ultrasoniques XPS-30 et XPS-40, éviter une forte exposition de la face émettrice à la lumière.

L'installation doit être effectuée par un personnel qualifié, en accord avec les dispositions locales en vigueur. Toute réparation du matériel devra être effectuée en accord avec les dispositions locales en vigueur et les consignes d'installation.

Ces systèmes doivent être alimentés par un système comportant un fusible approprié, avec un pouvoir de coupure de 4000A. Les contrôleurs de niveau Siemens Milltronics sont livrés avec ce type de fusible.

Ce système est conçu avec les matériaux suivants, nécessaires pour l'obtention de la certification :

Boîtier :	Kynar® 710
Protection isolante :	Stycast LA-9823-76



Utiliser le coupe-circuit prévu dans l'installation du transmetteur associé au transducteur pour déclencher une coupure manuellement.



## Marquage des produits



**Note :** Respecter les conditions d'utilisation pour garantir la résistance du Kynar® (polyfluorure de vinyle) à la plupart des produits chimiques. Se reporter aux tableaux de compatibilité chimique avant toute utilisation dans un environnement spécifique.





**AVERTISSEMENT :** Conformément à la Directive 97/23/CE, ce produit est un accessoire sous pression et **ne doit pas** être utilisé en tant qu'équipement de sécurité.



<b>SIEMENS</b>	
XCT-8 ULTRASONIC TRANSDUCER Serial No: GYZ / A1034567 Ambient Temp.: -40 °C to 145 °C V in: 1.77 V r.m.s.; 250 Vp I in: 44.2 mA r.m.s.	
Enclosure: IP66, IP68	Siemens Milltronics Process Instruments, Peterborough
 0518 	
ATENÇÃO - RISCO POTENCIAL DE CARGA ELETROSTÁTICA - VEJA INSTRUÇÕES	

<b>Segurança</b> 	Class I, Zone 1, Ex s I T4, Amb. Temp.: -40°C to 95°C Ex s IIC T3, Amb. Temp.: -40°C to 145°C DIP IP65 / IP67 ANZEx 08.3066X	
Ex mb IIIC T3 Gb Ex tb IIIC T135 °C Db DNV 12.0077 X	WARNING: Static Hazard, Do Not Rub With Dry Cloth.	Class I, Div 2, Group A, B, C, D Class II, Div 2, Group F, G Per Dwg.: 0-9650017Z-DI-A Max. Torque: 15 FT-LBS



<b>SIEMENS</b>	
XCT-12 ULTRASONIC TRANSDUCER Serial No: GYZ / A1034567 Ambient Temp.: -40 °C to 145 °C V in: 1.77 V r.m.s.; 250 Vp I in: 44.2 mA r.m.s.	
Enclosure: IP66, IP68	Siemens Milltronics Process Instruments, Peterborough
 0518 	
ATENÇÃO - RISCO POTENCIAL DE CARGA ELETROSTÁTICA - VEJA INSTRUÇÕES	

	Class I, Div 2, Group A, B, C, D Class II, Div 2, Group F, G Per Dwg.: 0-9650017Z-DI-A Max. Torque: 15 FT-LBS	 0518 
ATENÇÃO - RISCO POTENCIAL DE CARGA ELETROSTÁTICA - VEJA INSTRUÇÕES	WARNING: Static Hazard, Do Not Rub With Dry Cloth.	

**Note :**

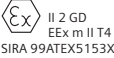

- Le numéro de configuration du produit est fourni à titre indicatif.
- Le numéro de série est fourni à titre indicatif.

## XPS-10

SIEMENS			
<b>XPS-10 ULTRASONIC TRANSDUCER</b> Serial No: GYZ / A1034567 Ambient Temp.: - 40 °C to 95 °C V in: 1.77 V r.m.s.; 250 Vp I in: 44.2 mA r.m.s.		 II 2 GD EEx m II T4 SIRA 99ATEX5153X	
Enclosure: IP66, IP68 Siemens Milltronics Process Instruments, Peterborough		Class I, Zone 1, Ex s IIIC T4 DIP IP65 / 67 ANZEx 08.3066X	
		 0518 KCC-REM-S49 Echomax	

 FM APPROVED	<b>WARNING:</b> Static Hazard, Do Not Rub With Dry Cloth.	<b>Segurança</b>  INMETRO
Class I, Div 2, Group A, B, C, D Class II, Div 1, Group E, F, G Per Dwg.: 0-9650017Z-DI-A Max. Torque: 15 FT-LBS	<b>ATENÇÃO - RISCO POTENCIAL DE CARGA ELETROSTÁTICA - VEJA INSTRUÇÕES</b>	Ex mb IIC T4 Gb Ex tb IIIC T135 °C Db DNV 12.0077 X

## XPS-15

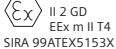

SIEMENS			
<b>XPS-15 ULTRASONIC TRANSDUCER</b> Serial No: GYZ / A1034567 Ambient Temp.: - 40°C to 95°C V in: 1.77 V r.m.s.; 250 Vp I in : 44.2 mA r.m.s.		 KCC-REM-S49 Echomax	
Enclosure: IP66, IP68 Siemens Milltronics Process Instruments, Peterborough		 0518	
		 II 2 GD EEx m II T4 SIRA 99ATEX5153X	
		Class I, Zone 1, Ex s IIIC T4 DIP IP65 / 67 ANZEx 08.3066X	

<b>Segurança</b>  INMETRO	 FM APPROVED	Class I, Div 2, Group A, B, C, D Class II, Div 1, Group E, F, G Per Dwg.: 0-9650017Z-DI-A Max. Torque: 15 FT-LBS
Ex mb IIC T4 Gb Ex tb IIIC T135 °C Db DNV 12.0077 X	<b>WARNING:</b> Static Hazard, Do Not Rub With Dry Cloth.	<b>ATENÇÃO - RISCO POTENCIAL DE CARGA ELETROSTÁTICA - VEJA INSTRUÇÕES</b>



## Note :

- Le numéro de configuration du produit est fourni à titre indicatif.
- Le numéro de série est fourni à titre indicatif.

<b>SIEMENS</b>		 KCC-REM-549 Echomax	 <b>0518</b>	 II 2G 1D EEx m II T4 SIRA 99ATEX5153X
<b>XPS-30 ULTRASONIC TRANSDUCER</b> Serial No: GYZ / A1034567 Ambient Temp.: - 40 °C to 95 °C V in: 1.77 V r.m.s.; 250 Vp I in: 44.2 mA r.m.s.      Enclosure: IP66, IP68 Siemens Milltronics Process Instruments, Peterborough				

<b>Segurança</b>  INMETRO DCP 8017 Ex mb IIC T4 Gb Ex tb IIIC T135 °C Db DNV 12.0077 X	 <b>FM</b> APPROVED	Class I, Div 2, Group A, B, C, D Class II, Div 1, Group E, F, G Per Dwg.: 0-9650017Z-DI-A Max. Torque: 15 FT-LBS (20 N-m)
		<b>WARNING:</b> Static Hazard, Do Not Rub With Dry Cloth. <b>ATENÇÃO - RISCO POTENCIAL DE CARGA ELETROSTÁTICA - VEJA INSTRUÇÕES</b>

<b>SIEMENS</b>		 KCC-REM-549 Echomax	 <b>0518</b>	 II 2G 1D EEx m II T4 SIRA 99ATEX5153X
<b>XPS-40 ULTRASONIC TRANSDUCER</b> Serial No: GYZ / A1034567 Ambient Temp.: - 40 °C to 95 °C V in: 1.77 V r.m.s.; 250 Vp I in: 44.2 mA r.m.s.      Enclosure: IP66, IP68 Siemens Milltronics Process Instruments, Peterborough				

<b>Segurança</b>  INMETRO DCP 8017 Ex mb IIC T4 Gb Ex tb IIIC T135 °C Db DNV 12.0077 X	 <b>FM</b> APPROVED	Class I, Div 2, Group A, B, C, D Class II, Div 1, Group E, F, G Per Dwg.: 0-9650017Z-DI-A Max. Torque: 15 FT-LBS (20 N-m)
		<b>WARNING:</b> Static Hazard, Do Not Rub With Dry Cloth. <b>ATENÇÃO - RISCO POTENCIAL DE CARGA ELETROSTÁTICA - VEJA INSTRUÇÕES</b>

## Note :

- Le numéro de configuration du produit est fourni à titre indicatif.
- Le numéro de série est fourni à titre indicatif.

# Caractéristiques Techniques

	XPS-10	XPS-15	XPS-30	XPS-40	XCT-8	XCT-12
Plage de mesure	0,3 - 10 m (1 - 33 ft)	0,3 - 15 m (1 - 50 ft)	0,6 - 30 m (2 - 100 ft)	0,9 - 40 m (3 - 130 ft)	0,6 - 8 m (2 - 26 ft)	0,6 - 12 m (2 - 40 ft)
Fréquence (kHz)	44	44	30	22	44	44
Angle du faisceau	12°	6°	6°	6°	12°	6°
<b>Caractéristiques environnementales</b>						
Emplacement	intérieur / extérieur	intérieur / extérieur	intérieur / extérieur	intérieur / extérieur	intérieur / extérieur	intérieur / extérieur
Altitude maximale (m)	2000	2000	2000	2000	2000	2000
Température ambiante	-40 à 95 °C (-40 à 203 °F)	-40 à 95 °C (-40 à 203 °F)	-40 à 95 °C (-40 à 203 °F)	-40 à 95 °C (-40 à 203 °F)	-40 à 145 °C (-40 à 293 °F)	-40 à 145 °C (-40 à 293 °F)
Pression	8 bar (120 psi)	8 bar (120 psi)	Europe : 0,5 bar Amérique du Nord : 15 psi	Europe : 0,5 bar Amérique du Nord : 15 psi	8 bar (120 psi)	8 bar (120 psi)
Degré de pollution	4	4	4	4	4	4
<b>Construction</b>						
Corps	PVDF	PVDF	PVDF	PVDF	<b>Standard</b> : PVDF <b>Option</b> : Bride universelle* et face émettrice en PTFE	
Montage	Raccord de conduit 1" NPT ou BSP	Raccord de conduit 1" NPT ou BSP	Raccord de conduit 1-1/2" NPT ou BSP	Raccord de conduit 1-1/2" NPT ou BSP	Raccord de conduit 1" NPT ou BSP	Raccord de conduit 1" NPT ou BSP
Options	<ul style="list-style-type: none"> <li>• bride installée en usine, configuration ANSI, DIN et JIS</li> <li>• face émettrice avec revêtement polyéthylène, efficace face à la poussière et aux vapeurs</li> <li>• kit de submersion pour applications présentant un risque de débordement (XPS-10 et XPS-15 uniquement)</li> <li>• brides folles pour configuration ANSI, DIN et JIS (sauf pour les transducteurs XPS-40)</li> </ul>					
Câble	2 conducteurs à paire torsadée/blindée, feuille métallique 0,5 mm (20 AWG), gaine PVC		<ul style="list-style-type: none"> <li>• 2 conducteurs à paire torsadée/blindée, feuille métallique 0,5 mm<sup>2</sup> (20 AWG), gaine PVC</li> </ul> <b>Séparation max. du transmetteur</b> : 100 m (330 ft)		Gaine silicone	
Poids**	0,8 kg (1,7 lb)	1,3 kg (2,8 lb)	4,3 kg (9,5 lb)	8 kg (18 lb)	0,8 kg (1,7 lb)	1,3 kg (2,8 lb)
Séparation max. du transmetteur :	365 m (1200 ft)	365 m (1200 ft)	365 m (1200 ft)	365 m (1200 ft)	365 m (1200 ft)	365 m (1200 ft)
Alimentation auxiliaire	Utilisation des transducteurs avec les transmetteurs Siemens Milltronics uniquement					
Homologations	CE***, CSA, FM, CENELEC/ATEX, INMETRO: Pour plus de détails se reporter à la plaque signalétique ou consulter Siemens Milltronics.					

\* Bride universelle pour configuration ANSI, DIN et JIS.

\*\* Poids d'expédition approximatif du transducteur avec câble (longueur standard).

\*\*\* Certificat CEM disponible sur demande.



# Encombrement

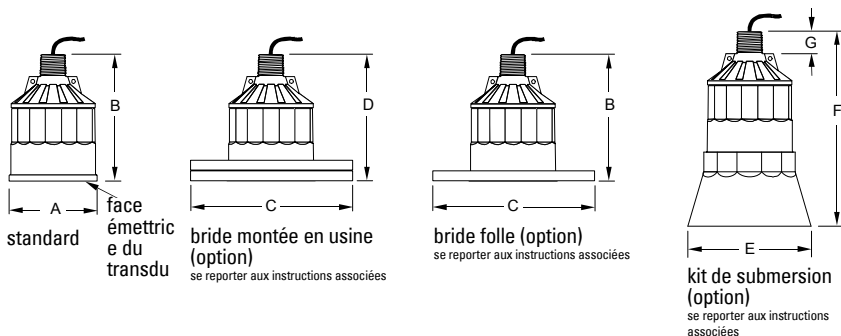

Dimension	XPS-10	XPS-15	XPS-30	XPS-40	XCT-8	XCT-12
A	88 mm (3,4")	121 mm (4,8")	175 mm (6,9")	206 mm (8,1")	88 mm (3,4")	121 mm (4,8")
B	122 mm (4,8")	132 mm (5,2")	198 mm (7,8")	229 mm (9,0")	122 mm (4,8")	132 mm (5,2")
C	adapté aux normes ANSI, DIN et JIS					
D*	128 mm (5,0")	138 mm (5,4")	204 mm (8,0")	235 mm (9,2")	128 mm (5,0")	138 mm (5,4")
E	124 mm (4,9")	158 mm (6,2")	n/a	n/a	n/a	n/a
F	152 mm (6,0")	198 mm (7,8")	n/a	n/a	n/a	n/a
G	28 mm (1,1")	28 mm (1,1")	28 mm (1,1")	28 mm (1,1")	28 mm (1,1")	28 mm (1,1")

\*nominale



**AVERTISSEMENT** : Les brides folles, les brides montées en usine ou les kits de fixation **ne doivent pas** être utilisés en cas de pression dans l'application.

# Montage

**AVERTISSEMENT : Protéger et manipuler la face émettrice du transducteur avec beaucoup de précaution pour éviter de l'endommager.**

- Lors du montage du transducteur, respecter une **distance minimale équivalente à la valeur de la zone morte au dessus du niveau maximum du matériau**. Pour plus de détails se reporter au manuel d'utilisation du transmetteur utilisé.
- Pour les applications avec des liquides, monter le transducteur de telle sorte que la face émettrice soit parallèle à la surface du liquide. Pour les applications avec des solides, utiliser le kit de fixation Easy Aimer de Siemens Milltronics pour l'orientation du transducteur.
- Eviter un serrage excessif du matériel. Un serrage manuel est généralement suffisant. Installer une chaîne de sécurité reliant le transducteur à la structure fixe pour éviter sa chute. Le transducteur peut être associé à un **capteur de température** optionnel. Ce capteur est particulièrement utile sur les transducteurs équipés de bride, sur les réservoirs présentant des hautes températures, ou pour obtenir une indication rapide de la température.

**Note :** Pour les applications étanches, serrer les transducteurs de  $\frac{1}{2}$  à  $1\frac{1}{2}$  tour(s) au-delà du serrage manuel. En cas de pression, utiliser un ruban PTFE ou un autre produit d'étanchéité pour garantir l'étanchéité des raccords filetés.

## Montage – Applications avec des solides

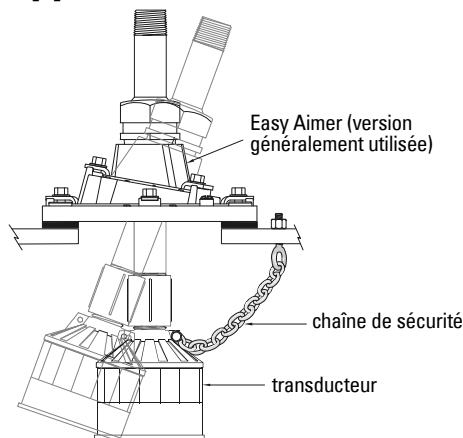

**AVERTISSEMENT :** Une installation erronée peut provoquer une chute de pression dans le process.

# Montage – Applications avec des solides

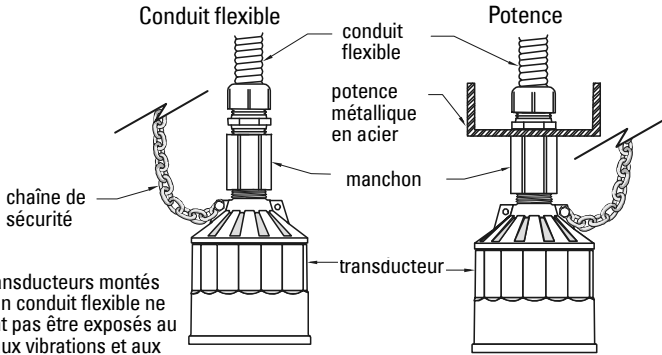

Les transducteurs montés avec un conduit flexible ne doivent pas être exposés au vent, aux vibrations et aux secousses.

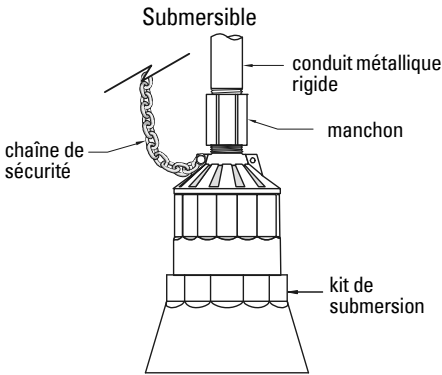

Transducteur équipé d'un kit de submersion, pour les applications présentant un risque de débordement.

## Plaque de bois

Le montage sur contreplaqué permet une excellente isolation aux vibrations. Prévoir une plaque suffisamment rigide pour éviter toute flexion.

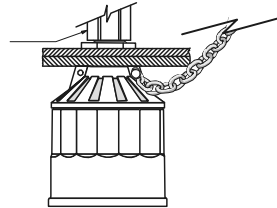

## Montage – Applications avec des liquides (suite)

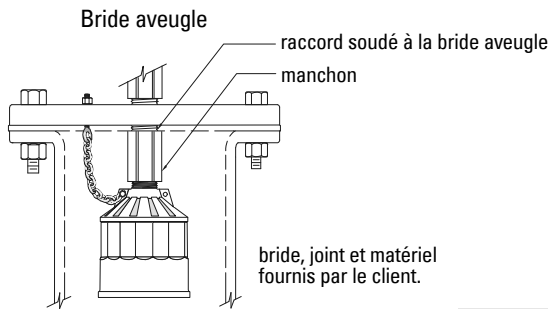

**Note :** Pour garantir l'étanchéité entre les différentes surfaces en contact, appliquer le même couple de serrage à toutes les vis (brides).

**Précaution :** Le serrage excessif peut affecter la performance du système.

### Montage sur bride

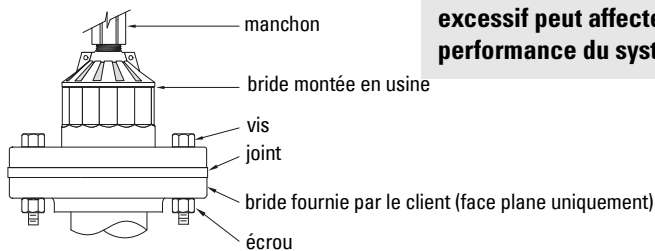

Rehausse avec montage bride fournie par le client. Pour plus de détails sur le soudage d'un bride métallique se reporter à la section Applications avec des liquides - Rehausse dans le *Guide d'application des transducteurs*.

## Installation

**Note :** L'installation doit être effectuée par un personnel qualifié, en accord avec les dispositions locales en vigueur.

- Le cheminement du câblage doit être effectué avec des protections adaptées. Pour garantir une isolation optimale contre les bruits électriques, installer le câble sous gaine métallique mise à la terre, sans aucun autre câble. Assurer un serrage hermétique des connexions pour éviter toute humidité d'infiltration.
- Eviter l'installation du câble près de sources haute tension ou haute intensité, contacteurs et systèmes de commande à thyristors. Pour les applications étanches, serrer les transducteurs de  $\frac{1}{2}$  à  $1\frac{1}{2}$  tour(s) au-delà du serrage manuel.
- En cas de pression, utiliser un ruban PTFE ou un autre produit d'étanchéité pour garantir l'étanchéité des raccords filetés.



**AVERTISSEMENT :** Ne jamais dévisser, retirer ou démonter le raccord process ou le boîtier du système lorsque l'intérieur de la cuve est sous pression.

# Interconnexions

## Connexion directe

Le transducteur doit être connecté directement au transmetteur Siemens Milltronics avec un câble blindé à 2 conducteurs.

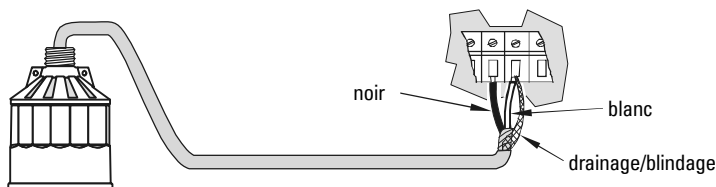

**Note :** Connecter le blindage, le câble blanc et le câble noir séparément lorsque le transducteur est relié à un transmetteur SITRANS LUT400, SITRANS LUC500, MultiRanger 100/200 ou HydroRanger 200. NE PAS associer le blindage et le câble blanc lors de la connexion.

## Extension coaxiale

Utiliser une boîte de jonction et un câble coaxial RG-62 A/U pour connecter le transducteur au transmetteur Siemens Milltronics. Ce type d'installation est conseillé pour les extensions de câble jusqu'à 365 m (1200 ft).

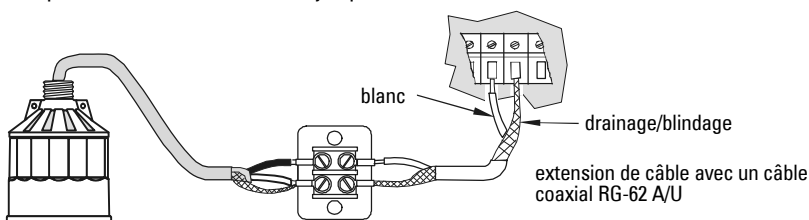

**Note :** Il est impératif de NE PAS utiliser un câble coaxial pour relier le transducteur à un transmetteur SITRANS LUT400, SITRANS LUC500, MultiRanger 100/200 ou HydroRanger 200. Se reporter au schéma ci-dessous.

## Extension 2 fils

(SITRANS LUT400, SITRANS LUC500, MultiRanger 100/200 et HydroRanger 200 uniquement)

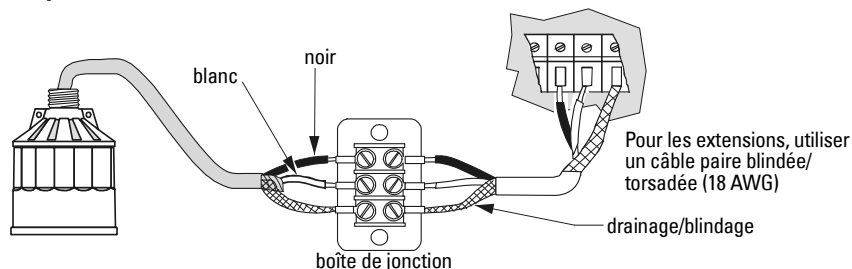



# Echomax XPS/XCT - Manuale operativo

Questo manuale descrive le funzioni principali dei trasduttori serie Echomax XPS/XCT. Questo documento così come il *Manuale di applicazione dei trasduttori* è disponibile per il download gratuito sul nostro sito web: [www.siemens.com/processautomation](http://www.siemens.com/processautomation). È possibile acquistare una versione stampata del manuale presso il proprio rappresentante locale di Siemens Milltronics.

Per ulteriori informazioni su questo manuale, rivolgersi a:

Siemens Milltronics Process Instruments  
1954 Technology Drive, P.O. Box 4225  
Peterborough, Ontario, Canada, K9J 7B1  
Email: [techpubs.smpi@siemens.com](mailto:techpubs.smpi@siemens.com)

Rappresentante europeo autorizzato

Siemens AG  
Industry Sector  
76181 Karlsruhe  
Deutschland

Italiano

**Copyright Siemens Milltronics  
Process Instruments 2013.  
Tutti i diritti riservati**

**Clausola di esclusione della responsabilità**

Si consiglia agli utenti di acquistare manuali stampati autorizzati oppure di consultare le versioni elettroniche progettate e realizzate da Siemens Milltronics Process Instruments. Siemens Milltronics Process Instruments non potrà essere ritenuta responsabile per la riproduzione parziale o totale del contenuto delle versioni stampata o elettronica.

La conformità tra lo stato tecnico dell'apparecchiatura e il contenuto di questo manuale è stata verificata; tuttavia, potrebbero essere riscontrate alcune variazioni. SMPI non garantisce pertanto la completa conformità del manuale con l'apparecchiatura descritta. Si avvisa inoltre che tutti i manuali vengono regolarmente controllati ed aggiornati e che le eventuali correzioni vengono incluse nelle versioni successive. Si invitano gli utenti a trasmettere i propri suggerimenti e commenti a SMPI. SMPI si riserva il diritto di apportare modifiche tecniche.

MILLTRONICS è un marchio registrato di Siemens Milltronics Process Instruments

## Indicazioni di sicurezza

L'apparecchiatura deve essere utilizzata osservando le avvertenze. Un utilizzo non corretto dello strumento potrebbe causare danni anche gravi alle persone, sia al prodotto e alle apparecchiature ad esso collegate. Le avvertenze contengono una spiegazione dettagliata del livello di sicurezza da osservare.



**ATTENZIONE:** questo simbolo sul prodotto indica che la mancata osservazione delle precauzioni necessarie può causare morte o gravi lesioni personali nonché seri danni materiali.



**ATTENZIONE:** questo simbolo indica che la mancata osservazione delle precauzioni necessarie può causare morte o gravi lesioni personali nonché seri danni materiali.

**AVVERTENZA:** questo simbolo indica che la mancata osservazione delle precauzioni necessarie può causare seri danni materiali.

**Nota:** le note contengono importanti informazioni sul prodotto o sulla sezione del manuale d'istruzioni a cui viene fatto riferimento.

## Riparazione dell'apparecchio ed esclusione di responsabilità

- L'utente è considerato responsabile di qualsiasi modifica e riparazione apportata al dispositivo dall'utente stesso o da chi per esso.
- Tutti i componenti nuovi devono essere forniti da Siemens Milltronics Process Instruments Inc.
- Le riparazioni vengono effettuate esclusivamente su componenti difettosi.
- Non riutilizzare componenti difettosi.



# Introduzione

**Il presente apparecchio è stato progettato e prodotto per l'uso in ambienti industriali. L'uso in zone residenziali può causare disturbi alle comunicazioni radiofoniche.**

I trasduttori serie Echomax XPS/XCT funzionano con prodotti di monitoraggio del livello ultrasonico Siemens Milltronics.

Il trasduttore converte in energia acustica l'energia elettrica dell'impulso di trasmissione proveniente dal controller. L'energia acustica dell'eco viene quindi di nuovo convertita in energia elettrica per il controller.

Il lato frontale del trasduttore emette energia acustica che si irradia verso l'esterno, diminuendo in ampiezza a una velocità inversamente proporzionale al quadrato della distanza. La potenza massima si irradia perpendicolarmente dal lato frontale del trasduttore lungo l'asse di trasmissione. Quando la potenza è ridotta del 50% (-3 dB), un confine conico centrato sull'asse di trasmissione definisce il fascio acustico, il cui diametro corrisponde all'apertura del fascio.

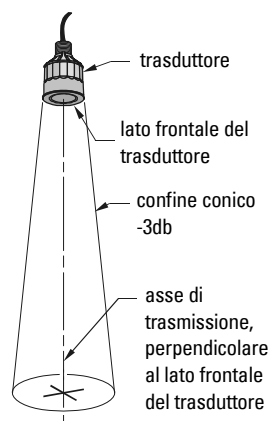

I trasduttori XPS/XCT sono dotati di un sensore di temperatura integrato che rileva la temperatura dell'aria presso il trasduttore e ne informa il controller.

## Indicazioni generali



**ATTENZIONE:** I materiali di composizione di questi apparecchi vengono scelti in base alla relativa compatibilità chimica (o inerzia) relativa all'uso generico dell'apparecchiatura. Per l'esposizione in ambienti specifici, verificare il grafico della compatibilità chimica prima di procedere all'installazione.

### Serie XPS/XCT – Certificato SIRA 99ATEX5153X

L'apparecchio può essere utilizzato in aree a rischio di presenza gas di Categoria 1, 2, 3 e 4 (Serie XPS: XPS-10, XPS-15, XPS-30 e XPS-40), e 1, 2 e T3 per la serie XCT (XCT-8 e XCT-12). I trasduttori serie XPS sono certificati per l'uso a temperature ambienti comprese tra -40 °C e 95 °C. I trasduttori serie XCT sono certificati per l'uso a temperature ambienti comprese tra -40 °C e 145 °C. Non utilizzare a temperature superiori o inferiori a tali gamme.

L'installazione deve essere eseguita esclusivamente da personale qualificato e in conformità con le normative locali correnti.

Questi dispositivi devono essere alimentati esclusivamente tramite un circuito contenente un fusibile di tensione nominale adeguata, con capacità di interruzione pari a 4000A. Tale fusibile è in dotazione nei ricetrasmittitori (controller) Siemens Milltronics.

Le riparazioni di questi apparecchi devono essere eseguite in conformità con i codici di procedura o le istruzioni di installazione applicabili.

La certificazione di questi trasduttori si basa sull'utilizzo dei seguenti materiali di fabbricazione:

	Serie XPS	Serie XCT
Custodia	Kynar® 710	Kynar® 710
Incapsulante	Stycast LA-9823-76	Durapot® 861-F3 & 864

1. Kynar® è un marchio registrato di ELF Atochem.  
Durapot® è un marchio registrato di Cotronics Corporation.

Per l'intervento manuale, utilizzare il sezionatore fornito nell'installazione del controller associato.

### Serie XPS 30/40 – Certificato SIRA 01ATEX5153X

L'apparecchio può essere utilizzato in tutte le aree a rischio di presenza polvere, per tutti i tipi di polveri, conduttive e non conduttive. I trasduttori XPS-30 e XPS-40 sopportano temperature superficiali massime di 135 °C (275 °F) (classe di temperatura T4). Queste unità sono certificate per l'uso a temperature ambienti comprese tra -40 e 95°C (-40 e 203°F). Non utilizzare a temperature superiori o inferiori a tale gamma. Montare i trasduttori XPS-30 e XPS-40 collocandoli in modo tale da non esporre la superficie irraggiante ad una fonte di luce diretta.

L'installazione deve essere eseguita esclusivamente da personale qualificato e in conformità con le normative locali correnti. Le riparazioni di questi apparecchi devono essere eseguite in conformità con i codici di procedura o le istruzioni di installazione applicabili.

Questi dispositivi devono essere alimentati esclusivamente tramite un circuito contenente un fusibile di tensione nominale adeguata, con capacità di interruzione pari a 4000A. Tale fusibile è in dotazione nei ricetrasmittitori (controller) Siemens Milltronics.

La certificazione di questi trasduttori si basa sull'utilizzo dei seguenti materiali di fabbricazione:

Custodia:	Kynar® 710
Incapsulante:	Stycast LA-9823-76

Per l'intervento manuale, utilizzare il sezionatore fornito nell'installazione del controller associato.



## Contrassegno prodotti



**Nota:** Kynar® fluoruro di polivinilidene è resistente alla maggior parte delle sostanze chimiche se si rispettano le condizioni di funzionamento descritte. Per l'esposizione in ambienti specifici, verificare il grafico della compatibilità chimica prima di procedere all'installazione.

**ATTENZIONE:** Questa apparecchiatura è stata definita accessorio a pressione nell'ambito della Direttiva 97/23/CE e **non è** destinata ad essere utilizzata come dispositivo sicuro.







## XCT-8

<b>SIEMENS</b>		 
<b>XCT-8 ULTRASONIC TRANSDUCER</b> Serial No: GYZ / A1034567 Ambient Temp.: -40 °C to 145 °C V in: 1.77 V r.m.s.; 250 Vp I in: 44.2 mA r.m.s.		
Siemens Milltronics Process Instruments, Peterborough		Enclosure: IP66, IP68 

	Class I, Zone 1, Ex s I T4, Amb. Temp.: -40°C to 95°C Ex s IIC T3, Amb. Temp.: -40°C to 145°C DIP IP65 / IP67 ANZEx 08.3066X	
	Ex mb IIIC T3 Gb Ex tb IIIC T135 °C Db DNV 12.0077 X	
WARNING: Static Hazard, Do Not Rub With Dry Cloth.		Class I, Div 2, Group A, B, C, D Class II, Div 2, Group F, G Per Dwg.: 0-9650017Z-DI-A Max. Torque: 15 FT-LBS

## XCT-12

<b>SIEMENS</b>		
<b>XCT-12 ULTRASONIC TRANSDUCER</b> Serial No: GYZ / A1034567 Ambient Temp.: -40 °C to 145 °C V in: 1.77 V r.m.s.; 250 Vp I in: 44.2 mA r.m.s.		
Siemens Milltronics Process Instruments, Peterborough		Enclosure: IP66, IP68 



	Class I, Div 2, Group A, B, C, D Class II, Div 2, Group F, G Per Dwg.: 0-9650017Z-DI-A Max. Torque: 15 FT-LBS	
	ATENÇÃO - RISCO POTENCIAL DE CARGA ELETROSTÁTICA - VEJA INSTRUÇÕES	
WARNING: Static Hazard, Do Not Rub With Dry Cloth.		Class I, Zone 1 Ex s I T4, Amb. Temp.: -40° C to 95°C Ex s IIC T3, Amb. Temp.: -40°C to 145°C DIP IP65 / IP67 ANZEx 08.3066X
		

### Nota:

- Il numero di configurazione è fornito a scopo informativo.
- Il numero di serie è fornito a scopo informativo.

## XPS-10

SIEMENS	
<b>XPS-10 ULTRASONIC TRANSDUCER</b> Serial No: GYZ / A1034567 Ambient Temp.: - 40 °C to 95 °C V in: 1.77 V r.m.s.; 250 Vp I in : 44.2 mA r.m.s.	 II 2 GD EEx m II T4 SIRA 99ATEX5153X Class I, Zone 1, Ex s IIIC T4 DIP IP65 / 67 ANZEx 08.3066X
Siemens Milltronics Process Instruments, Peterborough	

   
0518  
  
KCC-REM-S49  
Echomax

 Class I, Div 2, Group A, B, C, D Class II, Div 1, Group E, F, G Per Dwg.: 0-9650017Z-DI-A Max. Torque: 15 FT-LBS	<b>WARNING:</b> Static Hazard, Do Not Rub With Dry Cloth.	<b>Segurança</b>  Ex mb IIC T4 Gb Ex tb IIIC T135 °C Db DNV 12.0077 X
--	--	--

## XPS-15

SIEMENS	
<b>XPS-15 ULTRASONIC TRANSDUCER</b> Serial No: GYZ / A1034567 Ambient Temp.: - 40°C to 95°C V in: 1.77 V r.m.s.; 250 Vp I in : 44.2 mA r.m.s.	 II 2 GD EEx m II T4 SIRA 99ATEX5153X Class I, Zone 1, Ex s IIIC T4 DIP IP65 / 67 ANZEx 08.3066X
Siemens Milltronics Process Instruments, Peterborough	

   
0518  



<b>Segurança</b>  Ex mb IIC T4 Gb Ex tb IIIC T135 °C Db DNV 12.0077 X	 Class I, Div 2, Group A, B, C, D Class II, Div 1, Group E, F, G Per Dwg.: 0-9650017Z-DI-A Max. Torque: 15 FT-LBS	<b>WARNING:</b> Static Hazard, Do Not Rub With Dry Cloth. ATENÇÃO - RISCO POTENCIAL DE CARGA ELETROSTÁTICA - - VEJA INSTRUÇÕES
--	--	--

### Nota:

- Il numero di configurazione è fornito a scopo informativo.
- Il numero di serie è fornito a scopo informativo.



## XPS-30

SIEMENS	
<b>XPS-30 ULTRASONIC TRANSDUCER</b> Serial No: GYZ / A1034567 Ambient Temp.: - 40 °C to 95 °C V in: 1.77 V r.m.s.; 250 Vp I in: 44.2 mA r.m.s. Enclosure: IP66, IP68 Siemens Milltronics Process Instruments, Peterborough	   Class I, Zone 1, Ex s IIIC T4 DIP IP65 / 67 ANZEx 08.3066X

Segurança	
 Ex mb IIC T4 Gb Ex tb IIIC T135 °C Db DNV 12.0077 X	 Class I, Div 2, Group A, B, C, D Class II, Div 1, Group E, F, G Per Dwg.: 0-9650017Z-DI-A Max. Torque: 15 FT-LBS (20 N-m) <b>WARNING:</b> Static Hazard, Do Not Rub With Dry Cloth. <b>ATENÇÃO - RISCO POTENCIAL DE CARGA ELETROSTÁTICA - VEJA INSTRUÇÕES</b>

## XPS-40

SIEMENS	
<b>XPS-40 ULTRASONIC TRANSDUCER</b> Serial No: GYZ / A1034567 Ambient Temp.: - 40 °C to 95 °C V in: 1.77 V r.m.s.; 250 Vp I in: 44.2 mA r.m.s. Enclosure: IP66, IP68 Siemens Milltronics Process Instruments, Peterborough	   Class I, Zone 1, Ex s IIIC T4 DIP IP65 / 67 ANZEx 08.3066X

Segurança	
 Ex mb IIC T4 Gb Ex tb IIIC T135 °C Db DNV 12.0077 X	 Class I, Div 2, Group A, B, C, D Class II, Div 1, Group E, F, G Per Dwg.: 0-9650017Z-DI-A Max. Torque: 15 FT-LBS (20 N-m) <b>WARNING:</b> Static Hazard, Do Not Rub With Dry Cloth. <b>ATENÇÃO - RISCO POTENCIAL DE CARGA ELETROSTÁTICA - VEJA INSTRUÇÕES</b>

### Nota:

- Il numero di configurazione è fornito a scopo informativo.
- Il numero di serie è fornito a scopo informativo.

# Caratteristiche tecniche

	XPS-10	XPS-15	XPS-30	XPS-40	XCT-8	XCT-12	
<b>Campo di lavoro</b>	0,3 - 10 m (1 - 33 ft)	0,3 - 15 m (1 - 50 ft)	0,6 - 30 m (2 - 100 ft)	0,9 - 40 m (3 - 130 ft)	0,6 - 8 m (2 - 26 ft)	0,6 - 12 m (2 - 40 ft)	
<b>Frequenza (kHz)</b>	44	44	30	22	44	44	
<b>Angolo apertura</b>	12°	6°	6°	6°	12°	6°	
<b>Condizioni ambientali</b>							
<b>Collocazione</b>	interni/esterni	interni/esterni	interni/esterni	interni/esterni	interni/esterni	interni/esterni	
<b>Altitudine massima (m)</b>	2000	2000	2000	2000	2000	2000	
<b>Temperatura ambientale</b>	-40 a 95 °C (-40 a 203 °F)	-40 a 95 °C (-40 a 203 °F)	-40 a 95 °C (-40 a 203 °F)	-40 a 95 °C (-40 a 203 °F)	-40 a 145 °C (-40 a 293 °F)	-40 a 145 °C (-40 a 293 °F)	
<b>Pressione</b>	8 bar (120 psi)	8 bar (120 psi)	Europa: 0,5 bar Nord America: 15 psi	Europa: 0,5 bar Nord America: 15 psi	8 bar (120 psi)	8 bar (120 psi)	
<b>Grado inquinamento</b>	4	4	4	4	4	4	
<b>Struttura</b>							
<b>Custodia</b>	PVDF	PVDF	PVDF	PVDF	<b>Standard:</b> PVDF <b>Opzione:</b> Flangia universale* (PTFE)		
<b>Montaggio</b>	Collegamento tramite tubo con filettatura 1" NPT o BSP	Collegamento tramite tubo con filettatura 1" NPT o BSP	Collegamento tramite tubo con filettatura 1-1/2" NPT o BSP	Collegamento tramite tubo con filettatura 1-1/2" NPT o BSP	Collegamento tramite tubo con filettatura 1" NPT o BSP	Collegamento tramite tubo con filettatura 1" NPT o BSP	
<b>Opzioni</b>	<ul style="list-style-type: none"> <li>• Attacchi adatti per i standard ANSI, DIN, e JIS</li> <li>• superficie irraggiante di polietileno per aree con polvere o vapore</li> <li>• trasduttori sommergibili per applicazioni con possibilità di sommersione (solo XPS-10 e XPS-15)</li> <li>• flangia sciolta secondo standard ANSI, DIN, e JIS (escluso il XPS-40)</li> </ul>						
<b>Cavo</b>	a 2 fili schermato/bipolare, con guaina in PVC da 0.5mm2 (20 AWG)	<ul style="list-style-type: none"> <li>• a 2 fili schermato/bipolare, con guaina in PVC da 0.5mm2 (20 AWG)</li> <li><b>Distanza massima dal controller:</b> 100 m (330 ft)</li> </ul>		<ul style="list-style-type: none"> <li>• cavo coassiale RG-62 A/U</li> <li><b>Distanza massima:</b> 365 m (1200 ft)</li> </ul>			guaina in silicone
<b>Peso**</b>	0,8 kg (1,7 lb)	1,3 kg (2,8 lb)	4,3 kg (9,5 lb)	8 kg (18 lb)	0,8 kg (1,7 lb)	1,3 kg (2,8 lb)	
<b>Distanza massima dal controller</b>	365 m (1200 ft)	365 m (1200 ft)	365 m (1200 ft)	365 m (1200 ft)	365 m (1200 ft)	365 m (1200 ft)	
<b>Alimentazione</b>	I trasduttori devono essere alimentati esclusivamente tramite controller Siemens Milltronics certificati						
<b>Certificazioni</b>	CE***, CSA, FM, CENELEC/ATEX, INMETRO: Per informazioni sulle certificazioni correnti, consultare la targhetta di identificazione dell'apparecchio o contattare Siemens Milltronics.						

\* Flangia universale secondo standard ANSI, DIN, e JIS.

\*\* Peso approssimativo di spedizione del trasduttore incluso cavo di lunghezza standard.

\*\*\* Dati sulle prestazioni CEM disponibili su richiesta.

# Sagoma e dimensioni

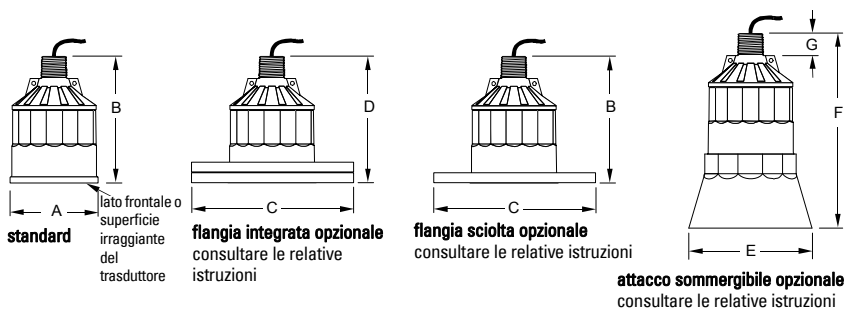

Dimensioni	XPS-10	XPS-15	XPS-30	XPS-40	XCT-8	XCT-12
A	88 mm (3,4")	121 mm (4,8")	175 mm (6,9")	206 mm (8,1")	88 mm (3,4")	121 mm (4,8")
B	122 mm (4,8")	132 mm (5,2")	198 mm (7,8")	229 mm (9,0")	122 mm (4,8")	132 mm (5,2")
C	attacchi adatti per i standard ANSI, DIN, e JIS					
D*	128 mm (5,0")	138 mm (5,4")	204 mm (8,0")	235 mm (9,2")	128 mm (5,0")	138 mm (5,4")
E	124 mm (4,9")	158 mm (6,2")	/	/	/	/
F	152 mm (6,0")	198 mm (7,8")	/	/	/	/
G	28 mm (1,1")	28 mm (1,1")	28 mm (1,1")	28 mm (1,1")	28 mm (1,1")	28 mm (1,1")

\* nominale



**ATTENZIONE:** I trasduttori dotati di flangie sciolte, flangie integrate e giunti di orientamento Easy Aimer **non** sono adatti alle applicazioni pressurizzate.

## Montaggio

**ATTENZIONE:** Manipolare il trasduttore con molta cautela e proteggere la superficie irradiante per evitare di danneggiarla.

- Montare il trasduttore collocandolo **al di sopra del livello materiale massimo, tenendo conto della zona di mascheramento (blanking)**. Fare riferimento al manuale del controller associato.
- Per le applicazioni in liquidi, il trasduttore deve essere installato in modo che l'asse di trasmissione risulti perpendicolare alla superficie del liquido in questione. Per le applicazioni su solidi, utilizzare un dispositivo Siemens Milltronics Easy Aimer per l'orientamento del trasduttore.
- Evitare un serraggio eccessivo. Nella maggior parte dei casi è sufficiente il serraggio manuale del materiale durante il montaggio. Fissare l'apparecchio collegando una catena di sicurezza tra il trasduttore e un elemento del supporto strutturale. Durante il montaggio delle esecuzioni flangiate considerare il  **sensore di temperatura opzionale** . Questo consente di ottenere una misura piu' veloce della temperatura ed è consigliato nelle applicazioni con temperature elevate.

**Nota:** In applicazioni pressurizzate fissare i trasduttori serrando manualmente e completare il serraggio con una coppia ½ - 1½. Nelle applicazioni pressurizzate è necessario applicare un apposito nastro PTFE o un sigillante adatto sulle filettature.

# Montaggio – Applicazioni in solidi

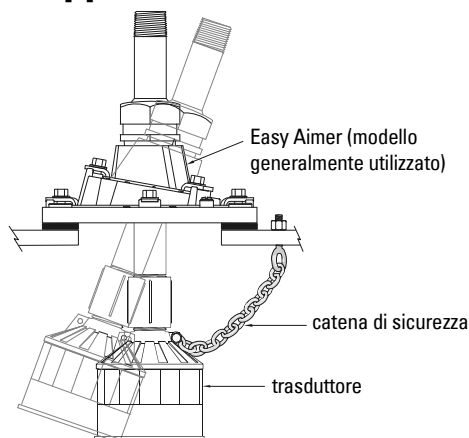

**ATTENZIONE:** L'installazione erranea può provocare un calo di pressione nel processo.

# Montaggio – Applicazioni in liquidi

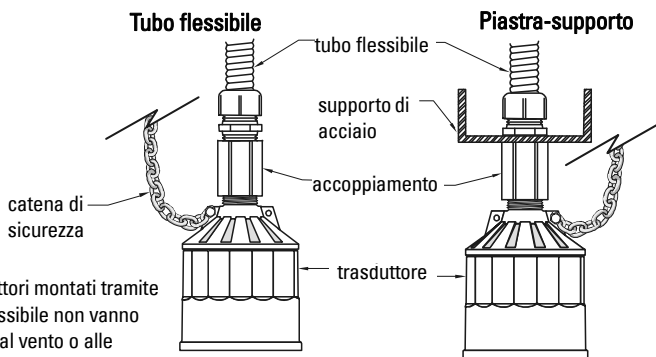

I trasduttori montati tramite tubo flessibile non vanno esposti al vento o alle vibrazioni.

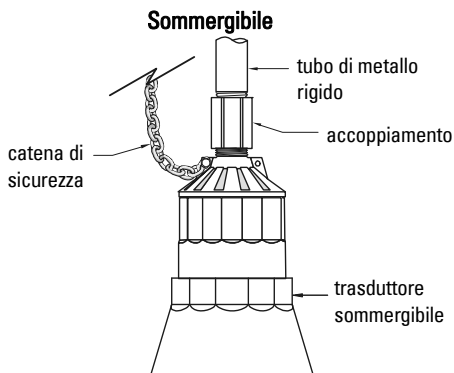

Esecuzione sommersibile per applicazione dove è possibile che il trasduttore venga sommerso.

## Placca di legno

Il montaggio tramite placca di legno consente un'ottima isolamento. Tuttavia la placca deve essere abbastanza rigida da non presentare flessioni sotto carico.

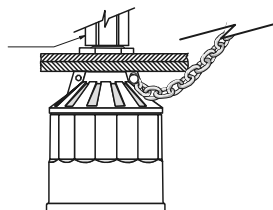



# Montaggio - Applicazioni in liquidi (segue)

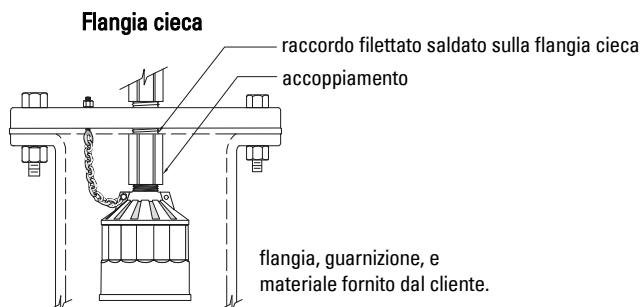

## Esecuzione flangiata

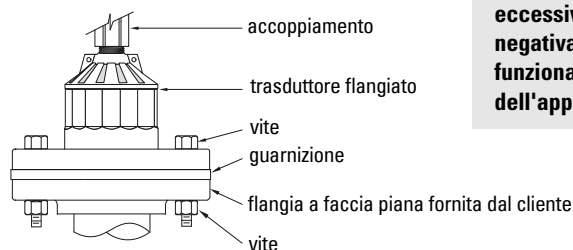

Colonna montante con flangia a cura del cliente. In alcuni casi può essere necessario saldare una flangia metallica sul tubo. Consultare la sezione Applicazioni in liquidi - Colonne montanti nel *Manuale di applicazione dei trasduttori*.

**Nota:** Garantire il serraggio uniforme delle viti della flangia per garantire una tenuta adeguata delle le superfici combacianti.

**Avvertenza:** Il serraggio eccessivo può influire negativamente sul funzionamento dell'apparecchiatura.

# Installazione

---

**Nota:** L'installazione deve essere eseguita esclusivamente da personale qualificato e in conformità con le normative locali correnti.

- Non sistemare i cavi lasciandoli scoperti. Sistemare i cavi separatamente all'interno di tubi protettivi di metallo con messa a terra, per proteggerli da disturbi e interferenze elettriche ambientali. Sigillare tutti i collegamenti filettati per evitare l'ingresso di umidità.
- Non sistemare il cavo vicino a fonti di alta tensione o circuiti elettrici, contattori o pannelli/quadri di comando SCR. In applicazioni pressurizzate fissare i trasduttori serrando manualmente e completare il serraggio con una coppia  $\frac{1}{2}$  -  $1\frac{1}{2}$ .
- Nelle applicazioni pressurizzate è necessario applicare un apposito nastro PTFE o un sigillante adatto sulle filettature.



**ATTENZIONE:** E' molto importante evitare di svitare, di ritirare o di smontare la connessione al processo quando il contenuto del serbatoio è sotto pressione.

# Intercollegamento

## Collegamento diretto

Collegare il trasduttore direttamente al controller Siemens Milltronics con un cavo elettrico bipolare schermato.

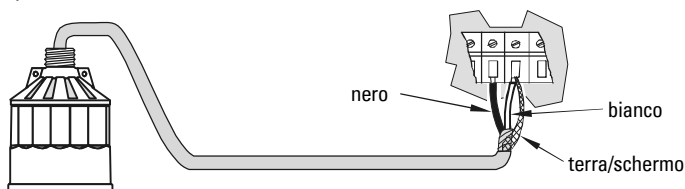

**Nota:** Per collegare il trasduttore a un ricetrasmittitore SITRANS LUT400, SITRANS LUC500, MultiRanger 100/200, o HydroRanger 200 collegare il cavo elettrico bianco, nero e lo schermo separatamente. **NON** collegare il cavo elettrico bianco e lo schermo insieme.

## Prolunga coassiale

Collegare il trasduttore al ricetrasmittitore Siemens Milltronics tramite una cassetta di giunzione e un cavo coassiale RG-62 A/U. Questo tipo di installazione è adatto quando la massima distanza tra il trasduttore ed il controller è 365 m (1200 ft).

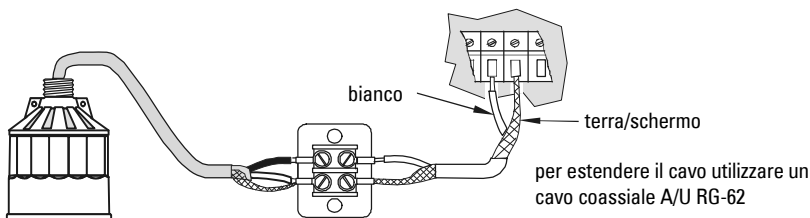

**Nota:** NON utilizzare un cavo coassiale per collegare il trasduttore ad un ricetrasmittitore SITRANS LUT400, SITRANS LUC500, MultiRanger 100/200 e HydroRanger 200. Consultare il diagramma.

## Prolunga a due fili

(solo per SITRANS LUT400, SITRANS LUC500, MultiRanger 100/200 e HydroRanger 200)

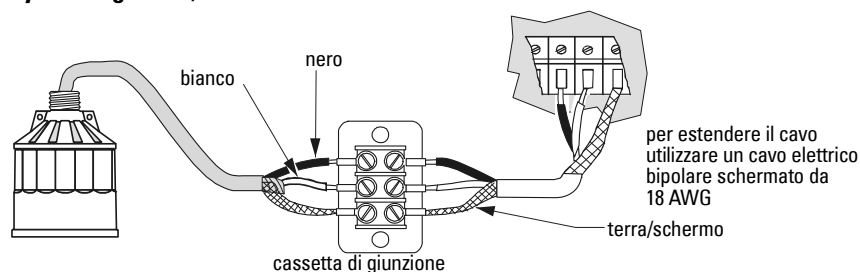



# Echomax XPS/XCT

## Bedieningshandleiding

Deze handleiding beschrijft de belangrijkste kenmerken en functies van Echomax XPS/XCT serie transducers. Deze handleiding en de *Transducer toepassingshandleiding*, zijn tevens beschikbaar op onze website: [www.siemens.com/processautomation](http://www.siemens.com/processautomation). De gedrukte handleidingen zijn leverbaar via uw lokale Siemens Milltronics vertegenwoordiging.

**Vragen omtrent de inhoud van deze handleiding kunnen worden gericht aan:** **Geautoriseerde Europese vertegenwoordiging**

Siemens Milltronics Process Instruments  
1954 Technology Drive, P.O. Box 4225  
Peterborough, Ontario, Canada, K9J 7B1  
Email: [techpubs.smpi@siemens.com](mailto:techpubs.smpi@siemens.com)

Siemens AG  
Industry Sector  
76181 Karlsruhe  
Deutschland

**Auteursrecht Siemens Milltronics  
Process Instruments 2013.  
Alle rechten voorbehouden**

**Disclaimer**

Wij raden gebruikers aan geautoriseerde, ingebonden gebruikershandleidingen te kopen, of om de elektronische versies te raadplegen, zoals ontworpen en goedgekeurd door Siemens Milltronics Process Instruments. Siemens Milltronics Process Instruments is niet aansprakelijk voor de inhoud van gedeeltelijk, of geheel gekopieerde versies, gebonden of elektronisch.

Hoewel we de inhoud van deze gebruikershandleiding hebben geverifieerd aan de omschreven instrumentatie, kunnen desondanks afwijkingen voorkomen. Wij kunnen derhalve niet een volledige overeenstemming garanderen. De inhoud van deze handleiding wordt regelmatig herzien, en correcties worden opgenomen in volgende uitgaven. Wij houden ons aanbevolen voor suggesties ter verbetering. Technische gegevens kunnen worden gewijzigd.

MILLTRONICS is een geregistreerd handelsmerk van Siemens Milltronics Process Instruments

## Veiligheidsrichtlijnen

Waarschuwingmeldingen moeten worden aangehouden om de eigen veiligheid en die van anderen te waarborgen en om het product en de aangesloten apparatuur te beschermen. Deze waarschuwingmeldingen gaan vergezeld met een verduidelijking van de mate van voorzichtigheid die moet worden aangehouden.



**Waarschuwing:** Heeft betrekking op een waarschuwingssymbool op het product en betekent dat het niet aanhouden van de noodzakelijke voorzorgsmaatregelen kan leiden tot ernstig of dodelijk letsel en/of aanzienlijke materiële schade.



**Waarschuwing:** betekent dat het niet aanhouden van de noodzakelijke voorzorgsmaatregelen kan leiden tot ernstig of dodelijk letsel en/of aanzienlijke materiële schade

**Opgelet:** betekent dat het niet aanhouden van de noodzakelijke voorzorgsmaatregelen kan leiden tot aanzienlijke materiële schade.

**Opmerking:** geeft belangrijke informatie aan over het product of dat deel van de gebruikershandleiding.

## **Reparatie van de eenheid en uitsluiting van aansprakelijkheid**

- De gebruiker is verantwoordelijk voor alle wijzigingen en reparaties die aan het apparaat worden uitgevoerd door de gebruiker of agent van de gebruiker.
- Alle nieuwe componenten moeten worden geleverd door Siemens Milltronics Process Instruments Inc.
- Beperkt de reparatie uitsluitend tot defecte componenten.
- Gebruik defecte componenten niet opnieuw.

# Inleiding

**Dit product is bedoeld voor gebruik in industriegebieden. Bij gebruik in woongebieden kunnen er storingen van verschillende radiografische toepassingen ontstaan.**

De Echomax XPS/XCT serie transducers werken in combinatie met de Siemens Milltronics producten voor ultrasonische niveaumeting.

De transducer converteert de elektrische energie van de zendpuls van de transceiver in een akoestische energie. Vervolgens converteert het de akoestische energie van de echo weer terug in elektrische energie voor de regelaar.

Het transducer-oppervlak zendt akoestische energie uit die uitwaaiert, waarbij de amplitude afneemt omgekeerd proportioneel aan het kwadraat van de afstand. Het maximale vermogen straalt haaks op het transducer-oppervlak op de as van de transmissie. Daar waar het vermogen met de helft wordt gereduceerd ( $-3$  dB), geeft een conische grens, gecentreerd rond de as van de transmissie de geluidsbundel, waarvan de diameter de bundelhoek is.

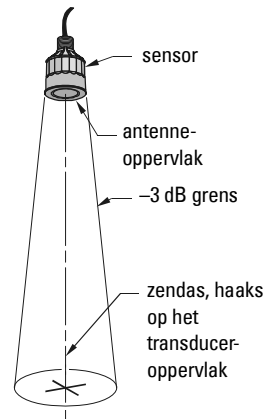

De XPS/XCT transducers zijn voorzien van een geïntegreerde temperatuursensor, welke de luchttemperatuur bij de transducer doorgeeft aan de regelaar.

## Algemene richtlijnen



**WAARSCHUWING:** Constructiematerialen zijn gekozen op basis van hun chemische compatibiliteit (of inerteheid) voor algemene doeleinden. Controleer voor blootstelling aan specifieke omgevingen, de chemische compatibiliteitstabellen voorafgaande aan de installatie.

### XPS/XCT serie – Certificaat SIRA 99ATEX5153X

Deze apparatuur mag worden gebruikt in explosiegevaarlijke gebieden voor alle gassen met de temperatuurklassen T1, T2, T3 en T4 voor de XPS serie (XPS-10, XPS-15, XPS-30, en XPS-40) en T1, T2, en T3 voor de XCT serie (XCT-8 en XCT-12). De XPS serie is alleen gecertificeerd voor gebruik in omgevingstemperaturen in het bereik van  $-40$  °C tot  $95$  °C en de XCT serie is uitsluitend gecertificeerd voor gebruik omgevingstemperaturen in het bereik van  $-40$  °C tot  $145$  °C. Geen van beide mag buiten hun respectievelijke temperatuurbereiken vallen.

De installatie moet worden uitgevoerd conform de geldende voorschriften door voldoende getraind personeel.

Deze apparaten mogen uitsluitend worden gevoed uit een schakeling die is voorzien van een voldoende zware zekering met een schakelpunt van 4000A. Deze zekering is opgenomen in Siemens Milltronics controllers.

Reparatie van deze apparatuur moet worden uitgevoerd conform de van toepassing zijnde richtlijnen.

De certificatie van deze apparatuur hangt af van de volgende materialen die in de constructie worden gebruikt:

	XPS serie	XCT serie
<b>Behuizing</b>	Kynar® 710	Kynar® 710
<b>Inkapseling</b>	Stycast LA-9823-76	Durapot® 861-F3 & 864

1. Kynar® is een geregistreerd handelsmerk van ELF Atochem  
Durapot® is een geregistreerd handelsmerk van Cotronics Corporation.

Gebruik voor een handmatige bediening de uit-schakelaar die zich bevindt in de gebouwinstallatie van de bijbehorende controller.

## XPS 30/40 serie – Certificaat SIRA 01ATEX5153X

Deze apparatuur mag uitsluitend worden gebruikt in explosiegevaarlijke stofzones bij alle geleidende en niet geleidende stofzones. De XPS-30 en XPS-40 type serie transducers hebben een maximale oppervlaktetemperatuur van 135 °C (275 °F) (Temperatuurklasse T4). Deze eenheden zijn gecertificeerd voor gebruik in het omgevingstemperatuurbereik van -40 tot 95 °C (-40 tot 203 °F). De transducers mogen niet worden gebruikt buiten dit temperatuurbereik. De XPS-30 en XPS-40 ultrasone transducers moeten zodanig worden geïnstalleerd dat het oppervlak van de transducer niet noemenswaardig wordt blootgesteld aan licht.

De installatie moet worden uitgevoerd conform de geldende voorschriften door voldoende getraind personeel. Reparatie van de apparatuur moet worden uitgevoerd conform de geldende voorschriften en installatie-instructies.

Deze apparaten mogen uitsluitend worden gevoed uit een schakeling die is voorzien van een voldoende zware zekering met een schakelpunt van 4000A. Deze zekering is opgenomen in Siemens Milltronics controllers.

De certificatie van deze apparatuur hangt af van de volgende materialen die in de constructie worden gebruikt:

<b>Behuizing:</b>	Kynar® 710
<b>Inkapseling:</b>	Stycast LA-9823-76

Gebruik voor een handmatige bediening de uit-schakelaar die zich bevindt in de gebouwinstallatie van de bijbehorende controller.

## Productidentificatie

**Opmerking:** Kynar® polyvinylideenflouride is bestand tegen de meeste chemicaliën onder de omschreven bedrijfsomstandigheden. Echter, raadpleeg voor blootstelling aan specifieke omgevingen, de chemische bestendigheidslijsten voorafgaande aan de installatie.



**WAARSCHUWING:** Dit product is ontworpen als druktoestel zoals vastgelegd in richtlijn 97/23/EC en is niet bedoeld voor gebruik als veiligheidsvoorziening.







## XCT-8

SIEMENS	
XCT-8 ULTRASONIC TRANSDUCER Serial No: GYZ / A1034567 Ambient Temp.: -40 °C to 145 °C V in: 1.77 V r.m.s.; 250 Vp I in: 44.2 mA r.m.s.	CE 0518 II 2 GD EEx m II T3 SIRA 99ATEX5153X KCC-REM-549 Echomax
Enclosure: IP66, IP68	ATENÇÃO - RISCO POTENCIAL DE CARGA ELETROSTÁTICA - VEJA INSTRUÇÕES
Siemens Milltronics Process Instruments, Peterborough	

Segurança	
 Ex mb IIIC T3 Gb Ex tb IIIC T135 °C Db DNV 12.0077 X	Class I, Zone 1, Ex s I T4, Amb. Temp.: -40°C to 95°C Ex s IIC T3, Amb. Temp.: -40°C to 145°C DIP IP65 / IP67 ANZEx 08.3066X <b>WARNING:</b> Static Hazard, Do Not Rub With Dry Cloth.
	 APPROVED Class I, Div 2, Group A, B, C, D Class II, Div 2, Group F, G Per Dwg.: 0-9650017Z-DI-A Max. Torque: 15 FT-LBS

## XCT-12



SIEMENS	
XCT-12 ULTRASONIC TRANSDUCER Serial No: GYZ / A1034567 Ambient Temp.: -40 °C to 145 °C V in: 1.77 V r.m.s.; 250 Vp I in: 44.2 mA r.m.s.	CE 0518 II 2 GD EEx m II T3 SIRA 99ATEX5153X KCC-REM-549 Echomax
Enclosure: IP66, IP68	ATENÇÃO - RISCO POTENCIAL DE CARGA ELETROSTÁTICA - VEJA INSTRUÇÕES
Siemens Milltronics Process Instruments, Peterborough	

Segurança	
 Ex mb IIIC T3 Gb Ex tb IIIC T135 °C Db DNV 12.0077 X	Class I, Zone 1 Ex s I T4, Amb. Temp.: -40°C to 95°C Ex s IIC T3, Amb. Temp.: -40°C to 145°C DIP IP65 / IP67 ANZEx 08.3066X <b>WARNING:</b> Static Hazard, Do Not Rub With Dry Cloth.
	 APPROVED Class I, Div 2, Group A, B, C, D Class II, Div 2, Group F, G Per Dwg.: 0-9650017Z-DI-A Max. Torque: 15 FT-LBS
ATENÇÃO - RISCO POTENCIAL DE CARGA ELETROSTÁTICA - VEJA INSTRUÇÕES	

### Opmerking:



- Product configuratienummer is uitsluitend als voorbeeld vermeld.
- Serienummer is uitsluitend als voorbeeld vermeld.

## XPS-10

SIEMENS	
<b>XPS-10 ULTRASONIC TRANSDUCER</b> Serial No: GYZ / A1034567 Ambient Temp.: - 40 °C to 95 °C V in : 1.77 V r.m.s.; 250 Vp I in : 44.2 mA r.m.s. Enclosure: IP66, IP68 Siemens Milltronics Process Instruments, Peterborough	 II 2 GD EEx m II T4 SIRA 99ATEX5153X Class I, Zone 1, Ex s IIIC T4 DIP IP65 / 67 ANZEx 08.3066X  0518 

 Class I, Div 2, Group A, B, C, D Class II, Div 1, Group E, F, G Per Dwg.: 0-9650017Z-DI-A Max. Torque: 15 FT-LBS	<b>WARNING:</b> Static Hazard, Do Not Rub With Dry Cloth.  <b>Segurança</b>  Ex mb IIC T4 Gb Ex tb IIIC T135 °C Db DNV 12.0077 X
--	--

## XPS-15

SIEMENS	
<b>XPS-15 ULTRASONIC TRANSDUCER</b> Serial No: GYZ / A1034567 Ambient Temp.: - 40°C to 95°C V in : 1.77 V r.m.s.; 250 Vp I in : 44.2 mA r.m.s. Enclosure: IP66, IP68 Siemens Milltronics Process Instruments, Peterborough	 0518  II 2 GD EEx m II T4 SIRA 99ATEX5153X Class I, Zone 1, Ex s IIIC T4 DIP IP65 / 67 ANZEx 08.3066X



<b>Segurança</b>  Ex mb IIC T4 Gb Ex tb IIIC T135 °C Db DNV 12.0077 X	 Class I, Div 2, Group A, B, C, D Class II, Div 1, Group E, F, G Per Dwg.: 0-9650017Z-DI-A Max. Torque: 15 FT-LBS <b>WARNING:</b> Static Hazard, Do Not Rub With Dry Cloth. <b>ATENÇÃO - RISCO POTENCIAL DE CARGA ELETROSTÁTICA - VEJA INSTRUÇÕES</b>
--	--

### Opmerking:

- Product configuratienummer is uitsluitend als voorbeeld vermeld.
- Serienummer is uitsluitend als voorbeeld vermeld.



## XPS-30

SIEMENS	
<b>XPS-30 ULTRASONIC TRANSDUCER</b> Serial No: GYZ / A1034567 Ambient Temp.: - 40 °C to 95 °C V in: 1.77 V r.m.s.; 250 Vp I in: 44.2 mA r.m.s. Enclosure: IP66, IP68 Siemens Milltronics Process Instruments, Peterborough	   Class I, Zone 1, Ex s IIIC T4 DIP IP65 / 67 ANZEx 08.3066X

Segurança	
 Ex mb IIC T4 Gb Ex tb IIIC T135 °C Db DNV 12.0077 X	 Class I, Div 2, Group A, B, C, D Class II, Div 1, Group E, F, G Per Dwg.: 0-9650017Z-DI-A Max. Torque: 15 FT-LBS (20 N-m) <b>WARNING:</b> Static Hazard, Do Not Rub With Dry Cloth. ATENÇÃO - RISCO POTENCIAL DE CARGA ELETROSTÁTICA - VEJA INSTRUÇÕES

## XPS-40

SIEMENS	
<b>XPS-40 ULTRASONIC TRANSDUCER</b> Serial No: GYZ / A1034567 Ambient Temp.: - 40 °C to 95 °C V in: 1.77 V r.m.s.; 250 Vp I in: 44.2 mA r.m.s. Enclosure: IP66, IP68 Siemens Milltronics Process Instruments, Peterborough	   Class I, Zone 1, Ex s IIIC T4 DIP IP65 / 67 ANZEx 08.3066X

Segurança	
 Ex mb IIC T4 Gb Ex tb IIIC T135 °C Db DNV 12.0077 X	 Class I, Div 2, Group A, B, C, D Class II, Div 1, Group E, F, G Per Dwg.: 0-9650017Z-DI-A Max. Torque: 15 FT-LBS (20 N-m) <b>WARNING:</b> Static Hazard, Do Not Rub With Dry Cloth. ATENÇÃO - RISCO POTENCIAL DE CARGA ELETROSTÁTICA - VEJA INSTRUÇÕES

### Opmerking:

- Product configuratienummer is uitsluitend als voorbeeld vermeld.
- Serienummer is uitsluitend als voorbeeld vermeld.

# Specificaties

	XPS-10	XPS-15	XPS-30	XPS-40	XCT-8	XCT-12
<b>Meetbereik</b>	0,3 - 10 m (1 - 33 ft)	0,3 - 15 m (1 - 50 ft)	0,6 - 30 m (2 - 100 ft)	0,9 - 40 m (3 - 130 ft)	0,6 - 8 m (2 - 26 ft)	0,6 - 12 m (2 - 40 ft)
<b>Frequentie (kHz)</b>	44	44	30	22	44	44
<b>Bundelhoek</b>	12°	6°	6°	6°	12°	6°
<b>Omgeving</b>						
<b>Locatie</b>	binnen/buiten	binnen/buiten	binnen/buiten	binnen/buiten	binnen/buiten	binnen/buiten
<b>Maximum Hoogte (m)</b>	2000	2000	2000	2000	2000	2000
<b>Omgevings-temperatuur</b>	-40 tot 95 °C (-40 tot 203 °F)	-40 tot 95 °C (-40 tot 203 °F)	-40 tot 95 °C (-40 tot 203 °F)	-40 tot 95 °C (-40 tot 203 °F)	-40 tot 145 °C (-40 tot 293 °F)	-40 tot 145 °C (-40 tot 293 °F)
<b>Druk</b>	8 bar (120 psi)	8 bar (120 psi)	Europa: 0,5 bar Noord Amerika: 15 psi	Europa: 0,5 bar Noord Amerika: 15 psi	8 bar (120 psi)	8 bar (120 psi)
<b>Vervuilingsgraad</b>	4	4	4	4	4	4
<b>Constructie</b>						
<b>Behuizing</b>	PVDF	PVDF	PVDF	PVDF	<b>Standaard:</b> PVDF <b>Optioneel:</b> Universele* flens beschikbaar met PTFE oppervlak	
<b>Montage</b>	1" NPT of BSP doorvoeraansluiting	1" NPT of BSP doorvoeraansluiting	1-1/2" NPT of BSP doorvoeraansluiting	1-1/2" NPT of BSP doorvoeraansluiting	1" NPT of BSP doorvoeraansluiting	1" NPT of BSP doorvoeraansluiting
<b>Opties</b>	<ul style="list-style-type: none"> <li>af fabriek gelijmd, geschikt voor ANSI, DIN, en JIS standaarden</li> <li>polyethyleen schuimoppervlak voor omgevingen met stof of stoom.</li> <li>onderdompelafscherming, daar waar overstroming kan optreden (alleen beschikbaar voor XPS-10, XPS-15)</li> <li>split flange voor veldmontage geschikt voor ANSI, DIN, en JIS standaarden (niet beschikbaar voor XPS-40)</li> </ul>					
<b>Kabel</b>	2-draads twisted pair/gevlochten en met folie afgeschermd, 0,5 mm <sup>2</sup> (20 AWG), PVC mantel		<ul style="list-style-type: none"> <li>2-draads twisted pair/gevlochten en met folie afgeschermd, 0,5 mm<sup>2</sup> (20 AWG), PVC mantel <b>Maximale afstand:</b> 100m (330ft)</li> <li>RG-62 A/U coax <b>Maximale afstand:</b> 365m (1200ft)</li> </ul>		Siliconen mantel	
<b>Gewicht**</b>	0,8 kg (1,7 lb)	1,3 kg (2,8 lb)	4,3 kg (9,5 lb)	8 kg (18 lb)	0,8 kg (1,7 lb)	1,3 kg (2,8 lb)
<b>Maximum afstand</b>	365m (1200 ft)	365m (1200 ft)	365m (1200 ft)	365m (1200 ft)	365m (1200 ft)	365m (1200 ft)
<b>Voeding</b>	Transducers mogen uitsluitend worden gevoed door controllers die door Siemens Milltronics zijn gecertificeerd					
<b>Goedkeuringen</b>	CE***, CSA, FM, CENELEC/ATEX, INMETRO: Raadpleeg typeplaatje of neem contact op met Siemens Milltronics voor de actuele goedkeuringen.					

\* Universele flens conform ANSI, DIN en JIS standaarden.

\*\* Verzendgewicht van transducer met standaard kabellengte (bij benadering).

\*\*\* EMC prestaties beschikbaar op aanvraag.

# Maatschets en afmetingen

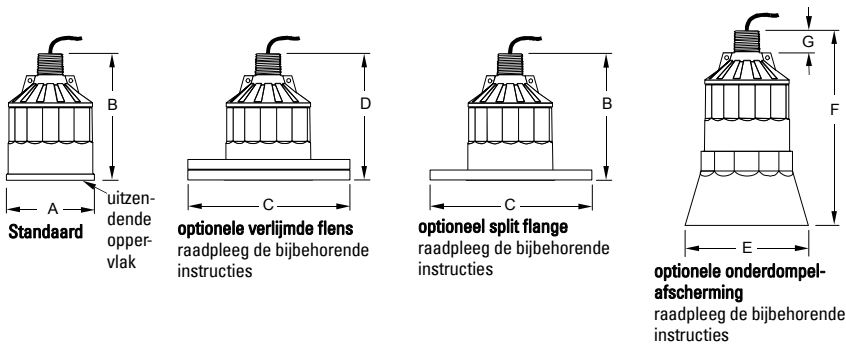

Afmetingen	XPS10	XPS-15	XPS-30	XPS-40	XCT-8	XCT-12
A	88 mm (3.4")	121 mm (4.8")	175 mm (6.9")	206 mm (8.1")	88 mm (3.4")	121 mm (4.8")
B	122 mm (4.8")	132 mm (5.2")	198 mm (7.8")	229 mm (9.0")	122 mm (4.8")	132 mm (5.2")
C	geschikt voor ANSI, DIN en JIS standaarden					
D*	128 mm (5.0")	138 mm (5.4")	204 mm (8.0")	235 mm (9.2")	128 mm (5.0")	138 mm (5.4")
E	124 mm (4.9")	158 mm (6.2")	n.v.t.	n.v.t.	n.v.t.	n.v.t.
F	152 mm (6.0")	198 mm (7.8")	n.v.t.	n.v.t.	n.v.t.	n.v.t.
G	28 mm (1.1")	28 mm (1.1")	28 mm (1.1")	28 mm (1.1")	28 mm (1.1")	28 mm (1.1")

\* nominaal



**WAARSCHUWING:** Optionele split flange, verlijmde flens, en Easy Aimer configuratie zijn niet geschikt voor druktoepassingen.

## Montage

**Waarschuwing: Speciale voorzorgsmaatregelen moeten worden genomen bij gebruik van de transducer om eventuele beschadiging van het oppervlak te voorkomen.**

- Monteer de transducer zodanig dat deze **zich tenminste met de blanking afstand boven het productniveau bevindt**. Raadpleeg de handleiding van de bijbehorende controller.
- Monteer bij vloeistoftoepassingen het transducer oppervlak parallel aan het vloeistofoppervlak. Gebruik voor stortgoedtoepassingen een Siemens Milltronics Easy Aimer voor het richten van de transducer.
- Bouten niet overmatig aanhalen. Voor de meeste toepassingen is het handmatig aanhalen van de bevestigingsmaterialen voldoende. Verbind een veiligheidsketting met een onderdeel van de constructie om de installatie te zekeren. Overweeg toepassing van de optionele **temperatuursensor** wanneer een met flens uitgevoerde transducer wordt gebruikt, wanneer een snelle temperatuurrepons is vereist of in tanks met hoge temperaturen.

**Opmerking:** Bij drukdichte toepassingen, de transducers handvast, plus ½ slag tot 1½ slagen extra aandraaien. PTFE tape of andere geschikt afdichtmiddel kan worden gebruikt als hulpmiddel voor het afdichten van de schroefdraden voor gebruik in druktoepassingen.

# Montage – Stortgoedtoepassingen

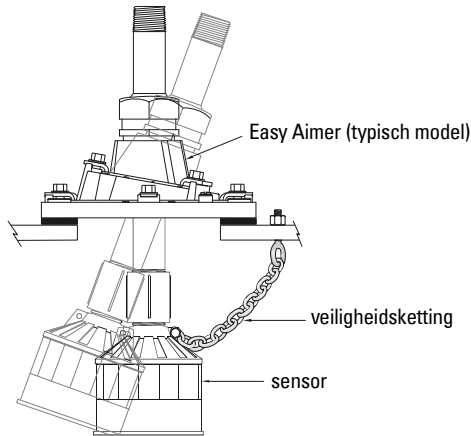

**WAARSCHUWING:** Onjuiste installatie kan leiden tot verlies aan procesdruk.

# Montage – Vloeistoftoepassingen

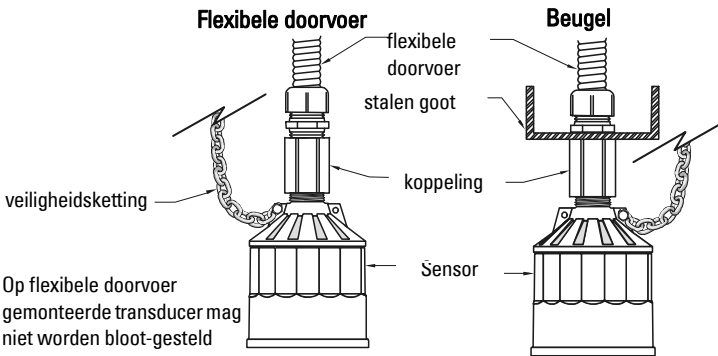

Op flexibele doorvoer gemonteerde transducer mag niet worden bloot-gesteld aan wind, trilling of schudden.

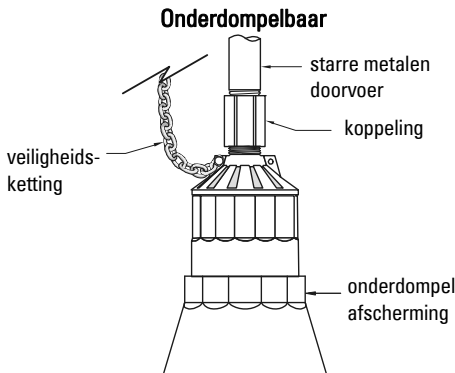

Transducer met onderdampelbescherming, gebruikt in toepassingen waar overstroming mogelijk is.

## Multiplex

Multiplex montage biedt uitstekende isolatie, maar moet star genoeg zijn om doorbuigen te voorkomen bij belasting.

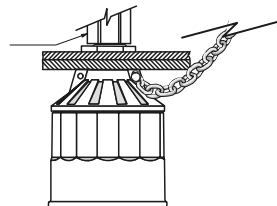

# Montage – Vloeistoftoepassingen (vervolgd)

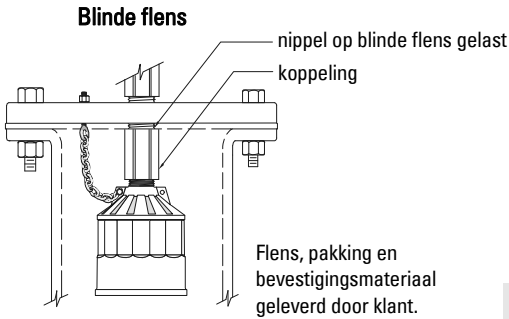

**Opmerking:** Draai de flensbouten gelijkmatig aan om een goede afdichting te waarborgen tussen de flenzen.

**Opgelet:** Het overmatig aanhalen kan de prestaties negatief beïnvloeden.

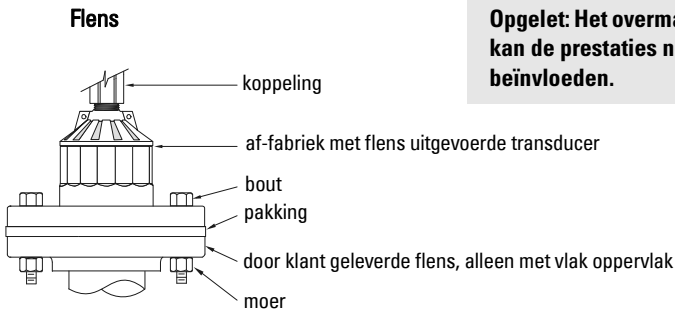

Door klant geleverde standpijp met flens. Wanneer een metalen flens op een standpijp moet worden gelast, raadpleeg dan *Vloeistoftoepassingen - Standpijpen in de Transducer-toepassingshandleiding*.

# Installatie

---

**Opmerking:** De installatie mag uitsluitend worden uitgevoerd door gekwalificeerd personeel en in overeenstemming met lokale regelgeving.

- Leg de bekabeling niet open. Voer de kabel afzonderlijk door een gearde metalen goot voor een optimale isolatie tegen elektrische ruis. Dicht alle schroefdraadaansluitingen af om indringen van vocht te voorkomen.
- Leg de kabel niet in de buurt van kabels met hoge spanningen of stromen, contactors, en microprocessorgestuurde gelijkrichters. Bij drukkichte toepassingen, de transducers handvast, plus ½ slag tot 1½ slagen extra aandraaien.
- PTFE tape of andere geschikt afdichtmiddel kan worden gebruikt als hulpmiddel voor het afdichten van de schroefdraden voor gebruik in druktoepassingen.



**WAARSCHUWING:** Probeer nooit de procesaansluiting los te draaien, te verwijderen of te demonteren terwijl de tank onder druk staat.



# Aansluiting

## Directe aansluiting

Sluit de transducer direct aan op de Siemens Milltronics transceiver, met de twee-aderige afschermingskabel.

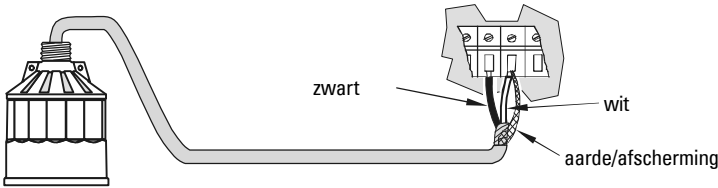

**Opmerking:** Bij het aansluiten van een SITRANS LUT400, een SITRANS LUC500, een MultiRanger 100/200, of een HydroRanger 200, worden de witte, zwarte en afschermingskabels alle afzonderlijk aangesloten. Sluit de witte en afschermingskabels NIET op elkaar aan.

## Coaxiaal aansluiting

Sluit de transducer aan op de Siemens Milltronics transceiver via een schakelkast en RG-62 A/U coax-kabel. Deze setup is doelmatig voor gecombineerde lengten tot max. 365 m (1200 ft).

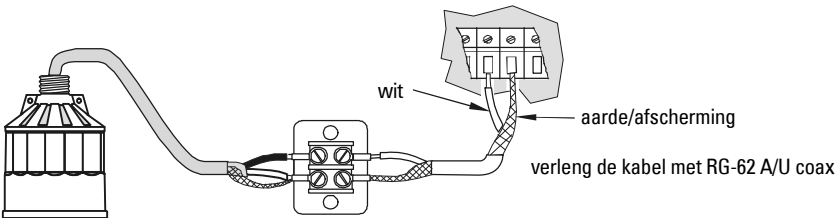

**Opmerking:** Bij het aansluiten van een SITRANS LUT400, SITRANS LUC500, MultiRanger 100/200 en HydroRanger 200, geen coax-kabel gebruiken; zie onderstaande schema voor de juiste procedure.

## 2-draads verlenging

(alleen voor SITRANS LUT400, SITRANS LUC500, MultiRanger 100/200, en HydroRanger 200)

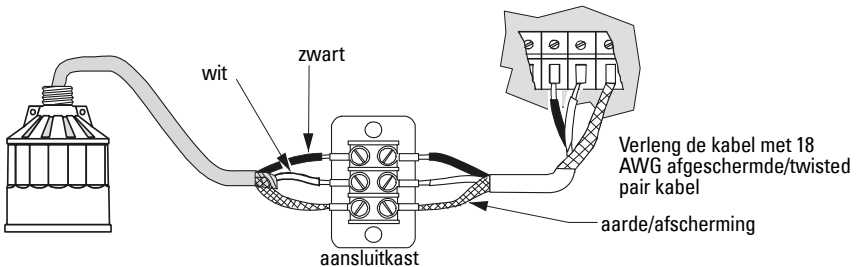



# Echomax XPS/XCT Manual de Operação

Este manual descreve em linhas gerais as principais características e funções dos transdutores Echomax Séries XPS/XCT. Este manual, e o *Manual de Aplicações do Transdutor*, estão igualmente disponíveis no nosso website: [www.siemens.com/processautomation](http://www.siemens.com/processautomation). Cópias impressas estão disponíveis no representante local da Siemens Milltronics.

**Quaisquer dúvidas acerca do conteúdo deste manual devem ser encaminhadas para:**

Siemens Milltronics Process Instruments  
1954 Technology Drive, P.O. Box 4225  
Peterborough, Ontario, Canada, K9J 7B1  
Email: [techpubs.smpi@siemens.com](mailto:techpubs.smpi@siemens.com)

**Representante Autorizado Europeu**

Siemens AG  
Industry Sector  
76181 Karlsruhe  
Deutschland

**Copyright Siemens Milltronics  
Process Instruments 2013.  
Todos os direitos reservados**

**Exclusão de Responsabilidade**

**Aconselhamos os usuários a adquirirem manuais autorizados relacionados, ou a verem versões eletrônicas como concebidas e autenticadas pela Siemens Milltronics Process Instruments. A Siemens Milltronics Process Instruments não se considera responsável pelo conteúdo de reproduções parciais ou totais de versões relacionadas ou eletrônicas.**

**Apesar de termos verificado o conteúdo deste manual relativamente à conformidade com os instrumentos descritos, este pode ter algumas variações. Assim, não podemos garantir completa conformidade. O conteúdo deste manual é revisto com regularidade e as correções são incluídas em edições posteriores. Todas as sugestões de melhoramento são bem-vindas. Os dados técnicos estão sujeitos a alterações.**

MILLTRONICS é uma marca comercial registrada da Siemens Milltronics Process Instruments

## Instruções de segurança

As mensagens de advertências devem ser observadas para garantir sua segurança pessoal bem como a de terceiros e para proteger o produto e os equipamentos a ele associado. Estas mensagens de advertências são acompanhadas por uma explicação do nível de cautela a se tomar.



**ATENÇÃO:** refere-se a um símbolo de aviso no produto e significa que o não cumprimento das precauções necessárias pode resultar em morte, ferimentos graves e/ou danos consideráveis ao material.



**ATENÇÃO:** significa que o não cumprimento das precauções necessárias pode resultar em morte, ferimentos graves e/ou danos consideráveis ao material.

**CUIDADO:** significa que o não cumprimento das precauções necessárias pode danificar consideravelmente o material.

**Nota:** significa informação importante sobre o produto ou dessa parte do manual de operação.

## **Reparo da Unidade e Exclusões de Responsabilidade**

- O usuário é responsável por todas as alterações e reparos feitos no instrumento por ele próprio ou por terceiros agindo por sua conta.
- Todos os componentes novos devem ser fornecidos pela Siemens Milltronics Process Instruments Inc.
- Reparos limitados apenas em componentes defeituosos.
- Não reutilizar componentes defeituosos.

# Introdução

**Este produto é para ser utilizado em áreas industriais. A operação deste equipamento numa área residencial pode causar interferências a várias comunicações à base de frequência.**

As linhas de transdutores Echomax XPS/XCT operam com produtos Siemens Milltronics de monitoramento de nível ultrassônicos.

O transdutor converte o pulso elétrico transmitido pelo emissor-receptor em energia acústica. Em seguida, converte a energia acústica do eco novamente em energia elétrica para o controlador.

A face do transdutor emite energia acústica, que diminui em amplitude a uma taxa inversamente proporcional ao quadrado da distância. A energia máxima é irradiada perpendicularmente desde a face do transdutor no eixo de transmissão. Onde a energia é reduzida pela metade (-3 dB), um limite formado pelo cone em torno do eixo central de transmissão define o feixe de som, o diâmetro do qual é o ângulo de feixe.

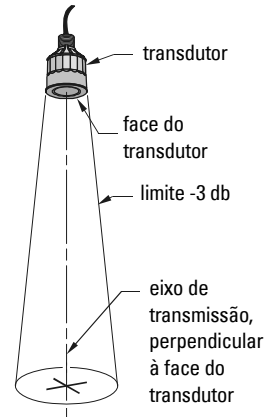

Os transdutores XPS/XCT possuem um sensor de temperatura integrado que informa a temperatura do ar no transdutor, para o controlador.

## Instruções Gerais



**ATENÇÃO:** Os materiais de construção são escolhidos com base em suas capacidades químicas (ou inatividade) para finalidades gerais. Para exposição em ambientes específicos, verificar as tabelas de compatibilidade química, antes da instalação.

### Séries XPS/XCT – Certificado SIRA 99ATEX553X

Este equipamento pode ser usado em áreas classificadas associado com todos os gases com classes de temperatura T1, T2, T3 e T4 para a série XPS (XPS-10, XPS-15, XPS-30, e XPS-40) e T1, T2, e T3 para a série XCT (XCT-8 e XCT-12). A linha XPS é certificada apenas para uso em temperaturas ambiente na faixa -40 °C a 95 °C e a linha XCT é certificada apenas para uso em temperaturas ambiente na faixa -40 °C a 145 °C. Nenhuma delas deverá ser usada fora da sua respectiva faixa de temperatura.

A instalação deverá ser efetuada em conformidade com o código de práticas aplicável, e por pessoal adequadamente habilitado.

Estes dispositivos só deverão ser alimentados a partir de um circuito possuindo um fusível adequadamente dimensionado que tenha uma capacidade de corte de 4.000 A. Este fusível está incluído nos controladores Siemens Milltronics.

O reparo deste equipamento deverá ser efetuada em conformidade com o código de práticas aplicável.

A certificação deste equipamento depende dos seguintes materiais utilizados na sua construção:

	Série XPS	Série XCT
Invólucro	Kynar® 710	Kynar® 710
Encapsulante	Stycast LA-9823-76	Durapot® 861-F3 & 864

1. Kynar® é uma marca comercial registrada da ELF Atochem.  
Durapot® é uma marca comercial registrada da Cotronics Corporation.

Para manobra manual, usar o interruptor de corte previsto na instalação do controlador associado.

### Série XPS 30/40 – Certificado SIRA 99ATEX553X

Este equipamento pode ser usado em atmosferas explosivas na presença de todas as poeiras condutoras e não condutoras. Os transdutores tipo XPS-30 e XPS-40 têm uma temperatura máxima na superfície de 135 °C (275 °F) (Classe de Temperatura T4). Estas unidades estão certificadas para uso numa faixa de temperatura ambiente de -40 a 95 °C (-40 a 203 °F). Os transdutores não devem ser usados fora desta faixa de temperatura. Os transdutores ultrassônicos XPS-30 e XPS-40 têm de ser instalados de forma que a face do transdutor não fique substancialmente sujeita à luz.

A instalação deverá ser efetuada em conformidade com o código de práticas aplicável, e por pessoal adequadamente habilitado. O reparo do equipamento deverá ser efetuado em conformidade com o código de práticas aplicável e com as instruções de instalação.

Estes dispositivos só deverão ser alimentados a partir de um circuito possuindo um fusível adequadamente dimensionado que tenha uma capacidade de corte de 4.000 A. Este fusível está incluído nos controladores Siemens Milltronics.

A certificação deste equipamento depende dos seguintes materiais utilizados em sua construção:

Invólucro:	Kynar® 710
Encapsulante:	Stycast LA-9823-76

Para manobra manual, usar o interruptor de corte previsto na instalação do controlador associado.



### Marcações do Produto



**Nota:** O fluoreto de polivinilideno Kynar® é resistente ao ataque da maioria dos químicos sob as condições de funcionamento descritas. Contudo, para exposição a ambientes específicos, verificar as tabelas de compatibilidades químicas, antes da instalação.

**ATENÇÃO:** Este produto é concebido como um Acessório de Pressão segundo a Directiva 97/23/EC e **não** se destina a ser utilizado como dispositivo de segurança.







## XCT-8

SIEMENS	
<b>XCT-8 ULTRASONIC TRANSDUCER</b> Serial No: GYZ / A1034567 Ambient Temp.: -40 °C to 145 °C V in: 1.77 V r.m.s.; 250 Vp I in: 44.2 mA r.m.s.	 
Enclosure: IP66, IP68	
Siemens Milltronics Process Instruments, Peterborough	<b>ATENÇÃO - RISCO POTENCIAL DE CARGA ELETROSTÁTICA - VEJA INSTRUÇÕES</b>

Segurança	
 Ex mb IIIC T3 Gb Ex tb IIIC T135 °C Db DNV 12.0077 X	Class I, Zone 1, Ex s I T4, Amb. Temp.: -40°C to 95°C Ex s II C T3, Amb. Temp.: -40°C to 145°C DIP IP65 / IP67 ANZEx 08.3066X <b>WARNING:</b> Static Hazard, Do Not Rub With Dry Cloth.
	 Class I, Div 2, Group A, B, C, D Class II, Div 2, Group F, G Per Dwg.: 0-9650017Z-DI-A Max. Torque: 15 FT-LBS

## XCT-12

SIEMENS	
<b>XCT-12 ULTRASONIC TRANSDUCER</b> Serial No: GYZ / A1034567 Ambient Temp.: -40 °C to 145 °C V in: 1.77 V r.m.s.; 250 Vp I in: 44.2 mA r.m.s.	
Enclosure: IP66, IP68	<b>Segurança</b>  Ex mb IIIC T3 Gb Ex tb IIIC T135 °C Db DNV 12.0077 X
Siemens Milltronics Process Instruments, Peterborough	



 Class I, Div 2, Group A, B, C, D Class II, Div 2, Group F, G Per Dwg.: 0-9650017Z-DI-A Max. Torque: 15 FT-LBS	 Class I, Zone 1 Ex s I T4, Amb. Temp.: -40°C to 95°C Ex s II C T3, Amb. Temp.: -40°C to 145°C DIP IP65 / IP67 ANZEx 08.3066X
<b>ATENÇÃO - RISCO POTENCIAL DE CARGA ELETROSTÁTICA - VEJA INSTRUÇÕES</b>	

### Nota:

- Código de configuração do produto mostrado unicamente como exemplo.
- Número de série mostrado unicamente como exemplo.

## XPS-10



SIEMENS	
<b>XPS-10 ULTRASONIC TRANSDUCER</b> Serial No: GYZ / A1034567 Ambient Temp.: - 40 °C to 95 °C V in : 1.77 V r.m.s.; 250 Vp I in : 44.2 mA r.m.s.	II 2 GD EEx m II T4 SIRA 99ATEX5153X Class I, Zone 1, Ex s IIIC T4 DIP IP65 / 67 ANZEx 08.3066X
Enclosure: IP66, IP68 Siemens Milltronics Process Instruments, Peterborough	

  0518  
KCC-REM-S49  
Echomax

 APPROVED Class I, Div 2, Group A, B, C, D Class II, Div 1, Group E, F, G Per Dwg.: 0-9650017Z-DI-A Max. Torque: 15 FT-LBS	<b>WARNING:</b> Static Hazard, Do Not Rub With Dry Cloth.	<b>Segurança</b>  INMETRO Ex mb IIC T4 Gb Ex tb IIIC T135 °C Db DNV 12.0077 X
ATENÇÃO - RISCO POTENCIAL DE CARGA ELETROSTÁTICA - VEJA INSTRUÇÕES		

## XPS-15

SIEMENS	
<b>XPS-15 ULTRASONIC TRANSDUCER</b> Serial No: GYZ / A1034567 Ambient Temp.: - 40°C to 95°C V in : 1.77 V r.m.s.; 250 Vp I in : 44.2 mA r.m.s.	II 2 GD EEx m II T4 SIRA 99ATEX5153X Class I, Zone 1, Ex s IIIC T4 DIP IP65 / 67 ANZEx 08.3066X
Enclosure: IP66, IP68 Siemens Milltronics Process Instruments, Peterborough	

  0518  
KCC-REM-S49  
Echomax

<b>Segurança</b>  INMETRO Ex mb IIC T4 Gb Ex tb IIIC T135 °C Db DNV 12.0077 X	 APPROVED Class I, Div 2, Group A, B, C, D Class II, Div 1, Group E, F, G Per Dwg.: 0-9650017Z-DI-A Max. Torque: 15 FT-LBS	<b>WARNING:</b> Static Hazard, Do Not Rub With Dry Cloth. ATENÇÃO - RISCO POTENCIAL DE CARGA ELETROSTÁTICA - VEJA INSTRUÇÕES
---	--	---



### Nota:

- Código de configuração do produto mostrado unicamente como exemplo.
- Número de série mostrado unicamente como exemplo.





## XPS-30

SIEMENS	
<b>XPS-30 ULTRASONIC TRANSDUCER</b> Serial No: GYZ / A1034567 Ambient Temp.: - 40 °C to 95 °C V in: 1.77 V r.m.s.; 250 Vp I in: 44.2 mA r.m.s. Enclosure: IP66, IP68 Siemens Milltronics Process Instruments, Peterborough	   Class I, Zone 1, Ex s IIIC T4 DIP IP65 / 67 ANZEx 08.3066X

Segurança	
 Ex mb IIC T4 Gb Ex tb IIIC T135 °C Db DNV 12.0077 X	 Class I, Div 2, Group A, B, C, D Class II, Div 1, Group E, F, G Per Dwg.: 0-9650017Z-DI-A Max. Torque: 15 FT-LBS (20 N-m) <b>WARNING:</b> Static Hazard, Do Not Rub With Dry Cloth. <b>ATENÇÃO - RISCO POTENCIAL DE CARGA ELETROSTÁTICA - VEJA INSTRUÇÕES</b>

## XPS-40

SIEMENS	
<b>XPS-40 ULTRASONIC TRANSDUCER</b> Serial No: GYZ / A1034567 Ambient Temp.: - 40 °C to 95 °C V in: 1.77 V r.m.s.; 250 Vp I in: 44.2 mA r.m.s. Enclosure: IP66, IP68 Siemens Milltronics Process Instruments, Peterborough	   Class I, Zone 1, Ex s IIIC T4 DIP IP65 / 67 ANZEx 08.3066X

Segurança	
 Ex mb IIC T4 Gb Ex tb IIIC T135 °C Db DNV 12.0077 X	 Class I, Div 2, Group A, B, C, D Class II, Div 1, Group E, F, G Per Dwg.: 0-9650017Z-DI-A Max. Torque: 15 FT-LBS (20 N-m) <b>WARNING:</b> Static Hazard, Do Not Rub With Dry Cloth. <b>ATENÇÃO - RISCO POTENCIAL DE CARGA ELETROSTÁTICA - VEJA INSTRUÇÕES</b>

### Nota:

- Código de configuração do produto mostrado unicamente como exemplo.
- Número de série mostrado unicamente como exemplo.

# Especificações

	XPS-10	XPS-15	XPS-30	XPS-40	XCT-8	XCT-12
<b>Faixa de medição</b>	0,3 - 10 m (1 - 33 pés)	0,3 - 15 m (1 - 50 pés)	0,6 - 30 m (2 - 100 pés)	0,9 - 40 m (3 - 130 pés)	0,6 - 8 m (2 - 26 pés)	0,6 - 12 m (2 - 40 pés)
<b>Frequência (kHz)</b>	44	44	30	22	44	44
<b>Ângulo do Feixe</b>	12°	6°	6°	6°	12°	6°
<b>Ambientais</b>						
<b>Localização</b>	interior/ exterior	interior/ exterior	interior/exterior	interior/exterior	interior/ exterior	interior/ exterior
<b>Altitude Máxima (m)</b>	2000	2000	2000	2000	2000	2000
<b>Temperatura Ambiente</b>	-40 a 95 °C (-40 a 203 °F)	-40 a 95 °C (-40 a 203 °F)	-40 a 95 °C (-40 a 203 °F)	-40 a 95 °C (-40 a 203 °F)	-40 a 145 °C (-40 a 293 °F)	-40 a 145 °C (-40 a 293 °F)
<b>Pressão</b>	8 bar (120 psi)	8 bar (120 psi)	Europa: 0,5 bar América do Norte: 15 psi	Europa: 0,5 bar América do Norte: 15 psi	8 bar (120 psi)	8 bar (120 psi)
<b>Grau de Poluição</b>	4	4	4	4	4	4
<b>Construção</b>						
<b>Invólucro</b>	PVDF	PVDF	PVDF	PVDF	<b>Standard:</b> PVDF <b>Opcional:</b> Flange tamanho universal* disponível com revestimento de PTFE	
<b>Montagem</b>	1" NPT ou ligação tubular BSP	1" NPT ou ligação tubular BSP	1-1/2" NPT ou ligação tubular BSP	1-1/2" NPT ou ligação tubular BSP	1" NPT ou ligação tubular BSP	1" NPT ou ligação tubular BSP
<b>Opções</b>	<ul style="list-style-type: none"> <li>ligado de fábrica para atender as normas ANSI, DIN, e JIS</li> <li>revestimento em espuma de polietileno para ambientes com poeiras ou úmidos</li> <li>proteção contra submersão, onde possam ocorrer inundações (só disponível para XPS-10, XPS-15)</li> <li>flange de separação para montagem no campo para atender as normas ANSI, DIN, e JIS (não disponível para XPS-40)</li> </ul>					
<b>Cabo</b>	2 condutores par trançado/ blindagem de folha metálica trançada, 0,5mm <sup>2</sup> (20 AWG), isolamento de PVC		<ul style="list-style-type: none"> <li>2 condutores par trançado/ blindagem de folha metálica trançada, 0,5mm<sup>2</sup> (20 AWG), isolamento de PVC</li> <li><b>Distância máxima:</b> 100 m (330 pés)</li> <li>RG-62 A/U coaxial</li> <li><b>Distância máxima:</b> 365 m (1200 pés)</li> </ul>		Isolação de silicone	
<b>Peso**</b>	0,8 kg (1,7 lb)	1,3 kg (2,8 lb)	4,3 kg (9,5 lb)	8 kg (18 lb)	0,8 kg (1,7 lb)	1,3 kg (2,8 lb)
<b>Distância Máxima</b>	365 m (1200 pés)	365 m (1200 pés)	365 m (1200 pés)	365 m (1200 pés)	365 m (1200 pés)	365 m (1200 pés)
<b>Fonte de Alimentação</b>	Os transdutores devem ser alimentados apenas por controladores certificados pela Siemens Milltronics					
<b>Aprovações</b>	CE***, CSA, FM, CENELEC/ATEX, INMETRO: Ver a placa de características ou consultar a Siemens Milltronics quanto a aprovações atuais.					

\* Flange universal segundo as normas ANSI, DIN, e JIS.

\*\* Peso aproximado de expedição do transdutor com comprimento padrão de cabo.

\*\*\* Performance EMC disponível por pedido.

# Desenhos e Dimensões

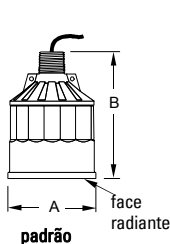

padrão

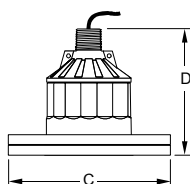

flange conectado opcional  
consultar as instruções associadas

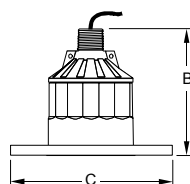

flange de separação opcional  
consultar as instruções associadas

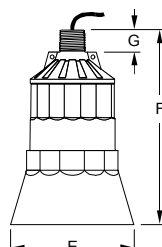

proteção contra submersão, opcional  
consultar as instruções associadas

Dimensões	XPS 10	XPS-15	XPS-30	XPS-40	XCT-8	XCT-12
A	88 mm (3,4")	121 mm (4,8")	175 mm (6,9")	206 mm (8,1")	88 mm (3,4")	121 mm (4,8")
B	122 mm (4,8")	132 mm (5,2")	198 mm (7,8")	229 mm (9,0")	122 mm (4,8")	132 mm (5,2")
C	de acordo com as normas ANSI, DIN e JIS					
D*	128 mm (5,0")	138 mm (5,4")	204 mm (8,0")	235 mm (9,2")	128 mm (5,0")	138 mm (5,4")
E	124 mm (4,9")	158 mm (6,2")	não disponível	não disponível	não disponível	não disponível
F	152 mm (6,0")	198 mm (7,8")	não disponível	não disponível	não disponível	não disponível
G	28 mm (1,1")	28 mm (1,1")	28 mm (1,1")	28 mm (1,1")	28 mm (1,1")	28 mm (1,1")

\* nominal



**ATENÇÃO:** As configurações Flange de Separação Opcional, Flange Conectado, e Direcionador Auxiliar não **são** adequados para aplicações com pressão.

# Montagem

**AVISO:** Devem ser tomadas precauções no manuseio para proteger a face do transdutor contra qualquer dano.

- Montar o transdutor de forma a ficar **acima do nível máximo do material, pelo menos na distância relativa da zona morta**. Consultar o manual do controlador associado.
- Em aplicações com líquidos, montar a face do transdutor paralela à superfície do líquido. Em aplicações com sólidos, utilizar um Direcionador Auxiliar Siemens Milltronics para direcionar o transdutor.
- Não apertar excessivamente. A maioria das aplicações requer apenas aperto manual do equipamento montado. Conectar uma corrente de segurança entre o transdutor e um elemento da estrutura para fixar a instalação. Considerar a utilização de um **sensor de temperatura** opcional quando for usado um transdutor flangeado e for necessária uma resposta de temperatura rápida, ou em reservatórios de alta temperatura.

**Nota:** Para aplicações pressurizadas, instalar os transdutores apertados à mão mais ½ volta a 1½ voltas. Fita de PTFE ou outro vedante apropriado pode ser usado para ajudar a vedação das roscas para uso em aplicações com pressão.

## Montagem – Aplicações com Sólidos

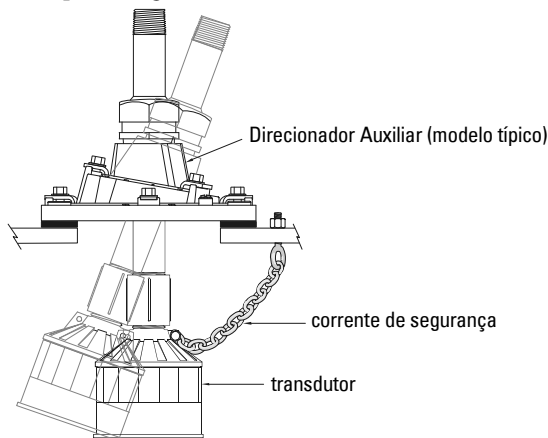

**ATENÇÃO:** Uma instalação incorreta pode resultar na perda de pressão do processo.

# Montagem – Aplicações com Líquidos

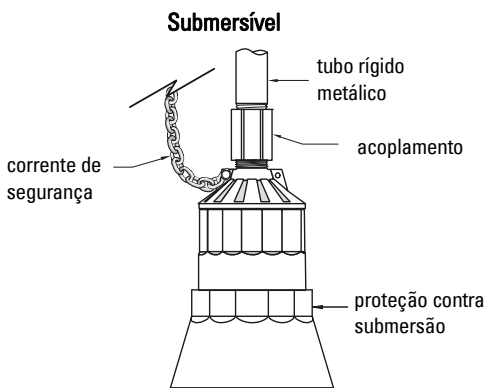
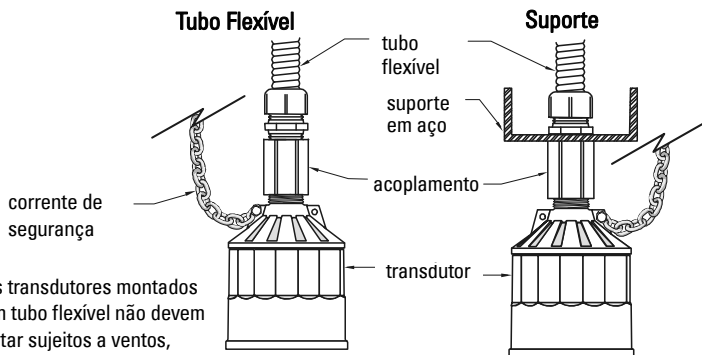

Transdutor com proteção contra submersão, usada em aplicações onde sejam possíveis inundações.

## Compensado de madeira

A montagem em compensado de madeira proporciona um excelente isolamento, mas deve ser suficientemente rígida para evitar a flexão, sob carga.

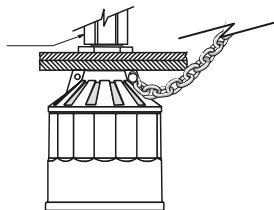

# Montagem – Aplicações com Líquidos (continuação)

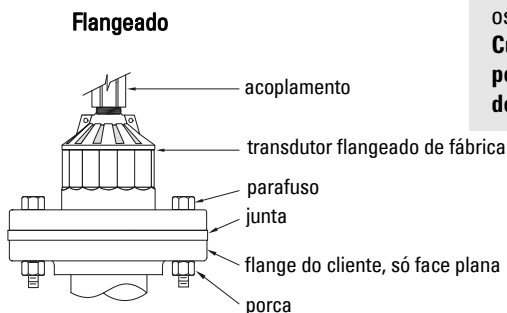
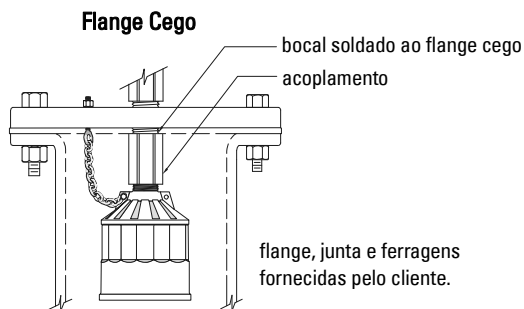

**Nota:** Apertar os parafusos do flange uniformemente a fim de garantir uma boa vedação entre os flanges de ligação.  
**Cuidado:** O aperto em demasia pode causar diminuição no desempenho.

Tubo de suporte, flangeado, do cliente. Se um flange metálico tiver de ser soldado ao tubo, consultar Aplicações com Líquidos – Tubos de Suporte no *Manual de Aplicações do Transdutor*.

## Instalação

**Nota:** A instalação só deverá ser efetuada por pessoal qualificado e em conformidade com os regulamentos locais vigentes.

- Não instalar o cabo em local aberto. Para um ótimo isolamento contra ruído elétrico, instalar o cabo separadamente em um conduíte metálico aterrado. Vedar todas as conexões rosçadas para impedir a entrada de umidade.
- Não instalar o cabo próximo de circuitos de alta tensão ou corrente, contatos, e acionadores de controle SCR. Para aplicações pressurizadas, instalar os transdutores à mão e apertar mais 1/2 a 1 1/2 voltas.
- Fita de PTFE ou outro vedante apropriado podem ser usados para ajudar na vedação de rosca em aplicações de pressão.



**ATENÇÃO:** Nunca tentar desapertar, retirar ou desmontar a ligação de processo enquanto o conteúdo do reservatório estiver sob pressão.

# Interligação

## Conexão Direta

Conectar o transdutor diretamente ao emissor-receptor Siemens Milltronics através de um cabo blindado, de dois condutores.

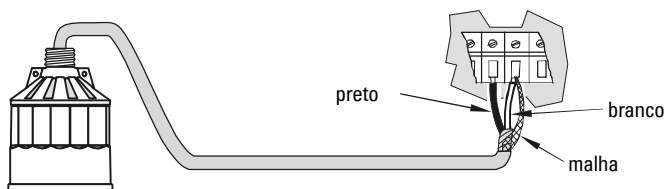

**Nota:** Ao ligar a um SITRANS LUT400, a um SITRANS LUC500, a um MultiRanger 100/200, ou a um HydroRanger 200, os condutores branco, preto e malha, são todos ligados separadamente. NÃO interligue os condutores branco e malha juntos.

## Conexão Coaxial

Conectar o transdutor ao emissor-receptor Siemens Milltronics através de uma caixa de junção e cabo coaxial RG-62 A/U. Este dispositivo é eficiente para extensões combinadas até 365 m (1200 pés).

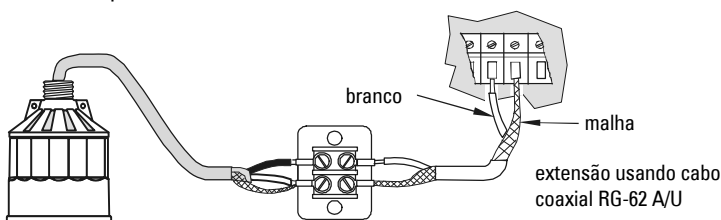

**Nota:** Ao ligar a um SITRANS LUT400, a um SITRANS LUC500, a um MultiRanger 100/200, e a um HydroRanger 200, NÃO usar cabo coaxial; ver o diagrama abaixo para procedimento correto.

## Extensão 2 Fios

(só para SITRANS LUT400, SITRANS LUC500, MultiRanger 100/200, e HydroRanger 200)

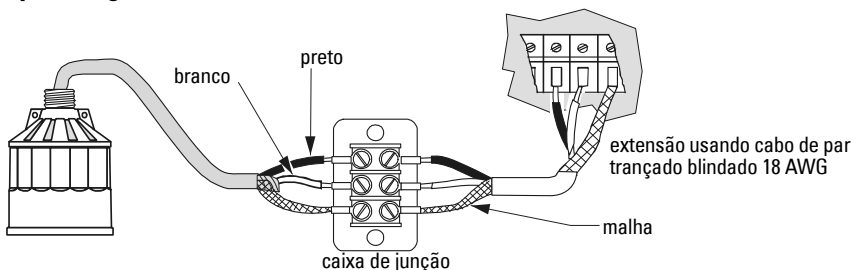





# Echomax XPS/XCT -käyttöohje

Tämä opas kertoo Echomax XPS/XCT -sarjan antureiden ominaisuuksista ja toiminnoista. Tämä opas sekä *Anturin sovellusopas* löytyvät myös verkkosivuiltamme osoitteesta [www.siemens.com/processautomation](http://www.siemens.com/processautomation). Painettuja oppaita saat paikalliselta Siemens Milltronics -edustajaltasi.

**Tämän oppaan sisältöä koskevia asioita voi tiedustella osoitteesta:**

Siemens Milltronics Process Instruments  
1954 Technology Drive, P.O. Box 4225  
Peterborough, Ontario, Canada, K9J 7B1  
Email: [techpubs.smpi@siemens.com](mailto:techpubs.smpi@siemens.com)

**Valtuutettu edustaja Euroopassa**

Siemens AG  
Industry Sector  
76181 Karlsruhe  
Deutschland

**Copyright Siemens Milltronics  
Process Instruments 2013.  
Kaikki oikeudet pidätetään**

**Vastuuvapauslauseke**

Kehotamme käyttäjiä hankkimaan oppaan hyväksytyyn painetun laitoksen tai tutustumaan Siemens Milltronics Process Instruments:n laatimaan ja hyväksymään sähköiseen versioon. Siemens Milltronics Process Instruments ei vastaa osittain tai kokonaan kopioitujen painettujen tai sähköisten versioiden sisällöstä.

Tämän oppaan sisältö on tarkistettu vastaamaan kuvattua laitteistoa, mutta muutokset ovat mahdollisia. Tämän vuoksi valmistaja ei voi taata täydellistä yhtäpitävyyttä. Tämän oppaan sisältöä tarkistetaan säännöllisesti ja korjaukset sisällytetään seuraaviin painoksiin. Otamme parannusehdotuksia mielellämme vastaan.

Teknisiin tietoihin saattaa tulla muutoksia.

MILLTRONICS on Siemens Milltronics Process Instruments:n rekisteröity tavaramerkki.

## Turvaohjeet

Annettuja varoituksia on noudatettava käyttäjään ja muihin henkilöihin kohdistuvien henkilövahinkojen sekä tuotteen ja siihen kytkettyjen varusteiden laitevahinkojen välttämiseksi. Varoitusten yhteydessä ilmoitetaan myös vaaratasosta.



**VAROITUS: Varoitus liittyy tuotteen varoitussymboliin. Varoituksen huomiotta jättäminen saattaa aiheuttaa hengenvaaran, vakavia ruumiinvammoja ja merkittäviä aineellisia vahinkoja.**



**VAROITUS: Varoituksen huomiotta jättäminen saattaa aiheuttaa hengenvaaran, vakavia ruumiinvammoja ja merkittäviä aineellisia vahinkoja.**

**HUOMIOITAVAA: Tämän huomautuksen huomiotta jättäminen saattaa aiheuttaa merkittäviä aineellisia vahinkoja.**

**Huomautus:** Huomautuksissa on tärkeitä tuotteeseen tai käyttöoppaaseen liittyviä tietoja.

## Laitteen korjaaminen ja vastuuvapauslauseke

- Käyttäjä on vastuussa kaikista muutoksista ja korjauksista, joita se tai sen edustaja tekee laitteelle.
- Kaikki uudet osat on hankittava Siemens Milltronics Process Instruments Inc:ltä.
- Korjaa ainoastaan vialliset osat.
- Älä käytä viallisia osia uudelleen.

# Johdanto

**Tämä tuote on tarkoitettu käytettäväksi teollisuustiloissa. Laitteen käyttäminen asuinalueilla saattaa aiheuttaa häiriöitä monenlaiseen radiotaajuuksia käyttävään viestintään.**

Echomax XPS/XCT -sarjan antureita käytetään Siemens Milltronicsin ultraäänitoimisten pintamittarien kanssa.

Anturi muuntaa lähetin-vastaanottimen tuottaman sähköisen mittauspulssin akustiseksi energiaksi. Sen jälkeen se muuntaa kaiun akustisen energian takaisin sähköenergiaksi ohjainta varten.

Anturin pinta lähettää ulospäin säteilevää akustista energiaa, jonka amplitudi pienenee käänteisessä suhteessa etäisyyden neliöön. Suurin säteilyteho kohdistuu anturin pinnasta kohtisuoraan mittausalun keskiviivaan. Alue, jolla teho pienenee puoleen ( $-3$  dB), muodostaa mittausalun keskiviivan ympärille keilan, joka määrittelee ultraäänien mittaussäteen ja jonka halkaisija on säteen kulma.

XPS/XCT-antureissa on integroitu lämpötilan mittapää, joka lähettää tiedon anturia ympäröivän ilman lämpötilasta ohjaimelle.

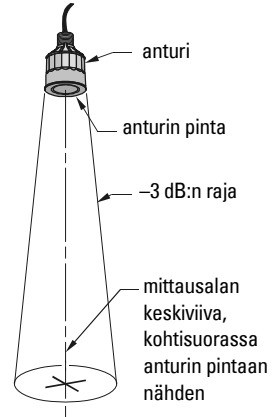

## Yleiset periaatteet



**VAROITUS:** Rakenneaineet valitaan yleisiin käyttötarkoituksiin niiden kemiallisen yhteensopivuuden (eli reagoimattomuuden) perusteella. Erityisympäristöille altistuvissa sovelluksissa kemiallinen yhteensopivuus on tarkistettava taulukoista ennen asennusta.

### XPS/XCT-sarja – SIRA 99ATEX5153X -sertifikaatti

Tätä laitetta saadaan käyttää räjähdysvaarallisissa tiloissa yhdessä kaikkien kaasujen kanssa XPS-sarjan (XPS-10, XPS-15, XPS-30 ja XPS-40) yhteydessä lämpötilaluokissa T1, T2, T3 ja T4 ja XCT-sarjan (XCT-8 ja XCT-12) yhteydessä lämpötilaluokissa T1, T2 ja T3. XPS-sarja on sertifioitu käytettäväksi ainoastaan  $-40$  -  $+95$  °C:n ympäristön lämpötilassa ja XCT-sarja ainoastaan  $-40$  -  $+145$  °C:n ympäristön lämpötilassa. Kummankaan sarjan laitteita ei tule käyttää niiden omien lämpötila-alueiden ulkopuolella.

Laitteet saa asentaa vain koulutettu henkilö sovellettavan standardin mukaisesti.

Laitteet saa kytkeä ainoastaan asianmukaisella sulakkeella varustettuun virtapiiriin. Sulakkeen katkaisukykyyn on oltava 4000 A. Sulake sisältyy Siemens Milltronics -ohjaimiin.

Nämä laitteet saa korjata vain sovellettavan käytännön mukaisesti.

Laitteiden sertifiointi perustuu seuraaviin laitteissa käytettyihin materiaaleihin:

	XPS-sarja	XCT-sarja
Kotelo	Kynar® 1710	Kynar® 710
Kapselointi	Stycast LA-9823-76	Durapot® 861-F3 & 864

1. Kynar® on ELF Atochemin rekisteröity tavaramerkki.  
Durapot® on Cotronics Corporationin rekisteröity tavaramerkki.

Käytä manuaaliseen ohituskytkentään erotuskytkintä, joka toimitetaan laitteisiin liittyvän ohjaimen tila-asennuksen mukana.

## XPS 30/40 -sarja – SIRA 01ATEX5153X -sertifikaatti

Näitä laitteita saadaan käyttää polyvaarallisilla alueilla sähköä johtavien tai johtamattomien pölyjen kanssa. XPS-30- ja XPS-40-tyypin sarjan anturien suurin sallittu pintalämpötila on 135 °C (275 °F) (lämpötilaluokka T4). Nämä yksiköt on sertifioitu käytettäväksi ympäristön lämpötila-alueella –40 – +95 °C (–40 – +203 °F). Antureita ei tule käyttää tämän lämpötila-alueen ulkopuolella. XPS-30- ja XPS-40-ultraäänianturit on asennettava niin, ettei anturin pinta altistu merkittävästi valolle.

Laitteet saa asentaa vain koulutettu henkilö sovellettavan käytännön mukaisesti. Nämä laitteet saa korjata vain sovellettavan käytännön ja asennusohjeiden mukaisesti.

Laitteet saa kytkeä ainoastaan asianmukaisella sulakkeella varustettuun virtapiiriin. Sulakkeen katkaisukyvyyn on oltava 4000 A. Sulake sisältyy Siemens Milltronics -ohjaimiin.

Laitteiden sertifiointi perustuu seuraaviin laitteissa käytettyihin materiaaleihin:

Kotelo:	Kynar® 710
Kapselointi:	Stycast LA-9823-76

Käytä manuaaliseen ohituskytkentään erotuskytkintä, joka toimitetaan laitteisiin liittyvän ohjaimen tila-asennuksen mukana.

## Tuotemerkinnät



**Huomautus:** Kynar® -polyvinylideenifluoridi kestää useimpia kemikaaleja ilmoitetuissa käyttöolosuhteissa. Erityisympäristöille altistuvissa sovelluksissa kemiallinen yhteensopivuus on tarkistettava taulukoista ennen asennusta.

**VAROITUS:** Tämä laite on direktiivin 97/23/EY mukainen painelaite, jota **ei** ole suunniteltu varolaitteeksi.





## XCT-8

SIEMENS	
XCT-8 ULTRASONIC TRANSDUCER Serial No: GYZ / A1034567 Ambient Temp.: -40 °C to 145 °C V in: 1.77 V r.m.s.; 250 Vp I in: 44.2 mA r.m.s.	CE 0518 II 2 GD EEx m II T3 SIRA 99ATEX5153X KCC-REM-549 Echomax
Enclosure: IP66, IP68	ATENÇÃO - RISCO POTENCIAL DE CARGA ELETROSTÁTICA - VEJA INSTRUÇÕES
Siemens Milltronics Process Instruments, Peterborough	

Segurança	
 Ex mb IIIC T3 Gb Ex tb IIIC T135 °C Db DNV 12.0077 X	Class I, Zone 1, Ex s I T4, Amb. Temp.: -40°C to 95°C Ex s II C T3, Amb. Temp.: -40°C to 145°C DIP IP65 / IP67 ANZEx 08.3066X <b>WARNING:</b> Static Hazard, Do Not Rub With Dry Cloth.
	Class I, Div 2, Group A, B, C, D Class II, Div 2, Group F, G Per Dwg.: 0-9650017Z-DI-A Max. Torque: 15 FT-LBS

## XCT-12





SIEMENS	
XCT-12 ULTRASONIC TRANSDUCER Serial No: GYZ / A1034567 Ambient Temp.: -40 °C to 145 °C V in: 1.77 V r.m.s.; 250 Vp I in: 44.2 mA r.m.s.	CE 0518 II 2 GD EEx m II T3 SIRA 99ATEX5153X KCC-REM-549 Echomax
Enclosure: IP66, IP68	ATENÇÃO - RISCO POTENCIAL DE CARGA ELETROSTÁTICA - VEJA INSTRUÇÕES
Siemens Milltronics Process Instruments, Peterborough	

Segurança	
 Ex mb IIIC T3 Gb Ex tb IIIC T135 °C Db DNV 12.0077 X	Class I, Zone 1 Ex s I T4, Amb. Temp.: -40°C to 95°C Ex s II C T3, Amb. Temp.: -40°C to 145°C DIP IP65 / IP67 ANZEx 08.3066X <b>WARNING:</b> Static Hazard, Do Not Rub With Dry Cloth.
	Class I, Div 2, Group A, B, C, D Class II, Div 2, Group F, G Per Dwg.: 0-9650017Z-DI-A Max. Torque: 15 FT-LBS

### Huomautus:





- Tuotemäärittelyn numero on annettu ainoastaan esimerkiksi.
- Sarjanumero on annettu ainoastaan esimerkiksi.

## XPS-10

SIEMENS	
<b>XPS-10 ULTRASONIC TRANSDUCER</b> Serial No: GYZ / A1034567 Ambient Temp.: - 40 °C to 95 °C V in: 1.77 V r.m.s.; 250 Vp I in: 44.2 mA r.m.s. Enclosure: IP66, IP68 Siemens Milltronics Process Instruments, Peterborough	 II 2 GD EEx m II T4 SIRA 99ATEX5153X Class I, Zone 1, Ex s IIIC T4 DIP IP65 / 67 ANZEx 08.3066X   0518  KCC-REM-S49 Echomax

 Class I, Div 2, Group A, B, C, D Class II, Div 1, Group E, F, G Per Dwg.: 0-9650017Z-DI-A Max. Torque: 15 FT-LBS	<b>WARNING:</b> Static Hazard, Do Not Rub With Dry Cloth.  <b>Segurança</b>  Ex mb IIC T4 Gb Ex tb IIIC T135 °C Db DNV 12.0077 X
--	--

## XPS-15

SIEMENS	
<b>XPS-15 ULTRASONIC TRANSDUCER</b> Serial No: GYZ / A1034567 Ambient Temp.: - 40°C to 95°C V in: 1.77 V r.m.s.; 250 Vp I in: 44.2 mA r.m.s. Enclosure: IP66, IP68 Siemens Milltronics Process Instruments, Peterborough	 KCC-REM-S49 Echomax   0518  II 2 GD EEx m II T4 SIRA 99ATEX5153X Class I, Zone 1, Ex s IIIC T4 DIP IP65 / 67 ANZEx 08.3066X



<b>Segurança</b>  Ex mb IIC T4 Gb Ex tb IIIC T135 °C Db DNV 12.0077 X	 Class I, Div 2, Group A, B, C, D Class II, Div 1, Group E, F, G Per Dwg.: 0-9650017Z-DI-A Max. Torque: 15 FT-LBS <b>WARNING:</b> Static Hazard, Do Not Rub With Dry Cloth. <b>ATENÇÃO - RISCO POTENCIAL DE CARGA ELETROSTÁTICA - VEJA INSTRUÇÕES</b>
--	--

### Huomautus:

- Tuotemäärittelyn numero on annettu ainoastaan esimerkiksi.
- Sarjanumero on annettu ainoastaan esimerkiksi.



## XPS-30

SIEMENS	
<b>XPS-30 ULTRASONIC TRANSDUCER</b> Serial No: GYZ / A1034567 Ambient Temp.: - 40 °C to 95 °C V in: 1.77 V r.m.s.; 250 Vp I in: 44.2 mA r.m.s. Enclosure: IP66, IP68 Siemens Milltronics Process Instruments, Peterborough	   Class I, Zone 1, Ex s IIIC T4 DIP IP65 / 67 ANZEx 08.3066X

Segurança	
 Ex mb IIC T4 Gb Ex tb IIIC T135 °C Db DNV 12.0077 X	 Class I, Div 2, Group A, B, C, D Class II, Div 1, Group E, F, G Per Dwg.: 0-9650017Z-DI-A Max. Torque: 15 FT-LBS (20 N-m) <b>WARNING:</b> Static Hazard, Do Not Rub With Dry Cloth. <b>ATENÇÃO - RISCO POTENCIAL DE CARGA ELETROSTÁTICA - VEJA INSTRUÇÕES</b>

## XPS-40

SIEMENS	
<b>XPS-40 ULTRASONIC TRANSDUCER</b> Serial No: GYZ / A1034567 Ambient Temp.: - 40 °C to 95 °C V in: 1.77 V r.m.s.; 250 Vp I in: 44.2 mA r.m.s. Enclosure: IP66, IP68 Siemens Milltronics Process Instruments, Peterborough	   Class I, Zone 1, Ex s IIIC T4 DIP IP65 / 67 ANZEx 08.3066X

Segurança	
 Ex mb IIC T4 Gb Ex tb IIIC T135 °C Db DNV 12.0077 X	 Class I, Div 2, Group A, B, C, D Class II, Div 1, Group E, F, G Per Dwg.: 0-9650017Z-DI-A Max. Torque: 15 FT-LBS (20 N-m) <b>WARNING:</b> Static Hazard, Do Not Rub With Dry Cloth. <b>ATENÇÃO - RISCO POTENCIAL DE CARGA ELETROSTÁTICA - VEJA INSTRUÇÕES</b>

### Huomautus:

- Tuotemäärityksen numero on annettu ainoastaan esimerkiksi.
- Sarjanumero on annettu ainoastaan esimerkiksi.

# Tekniset tiedot

	XPS-10	XPS-15	XPS-30	XPS-40	XCT-8	XCT-12
<b>Mittausalue</b>	0,3–10 m (1–33 ft)	0,3–15 m (1–50 ft)	0,6–30 m (2–100 ft)	0,9–40 m (3–130 ft)	0,6–8 m (2–26 ft)	0,6–12 m (2–40 ft)
<b>Taajuus (kHz)</b>	44	44	30	22	44	44
<b>Säteen kulma</b>	12°	6°	6°	6°	12°	6°
<b>Ympäristötiedot</b>						
<b>Paikka</b>	sisällä/ulkona	sisällä/ulkona	sisällä/ulkona	sisällä/ulkona	sisällä/ulkona	sisällä/ulkona
<b>Enimmäis- korkeus (m)</b>	2000	2000	2000	2000	2000	2000
<b>Ympäristön lämpötila</b>	–40 – +95 °C (–40 – +203 °F)	–40 – +95 °C (–40 – +203 °F)	–40 – +95 °C (–40 – +203 °F)	–40 – +95 °C (–40 – +203 °F)	–40 – +145 °C (–40 – +293 °F)	–40 – +145 °C (–40 – +293 °F)
<b>Paine</b>	8 baaria (120 psi)	8 baaria (120 psi)	Eurooppa: 0,5 baaria P-Amerikka: 15 psi	Eurooppa: 0,5 baaria P-Amerikka: 15 psi	8 baaria (120 psi)	8 baaria (120 psi)
<b>Likaantumisaste</b>	4	4	4	4	4	4
<b>Rakenne</b>						
<b>Kotelo</b>	PVDF	PVDF	PVDF	PVDF	<b>Vakio:</b> PVDF <b>Valinnainen:</b> Saatavana yleismitoitettu* laippa Teflon-päälysteellä	
<b>Asennus</b>	1":n NPT tai BSP-putki-liitäntä	1":n NPT tai BSP-putki-liitäntä	1-1/2":n NPT tai BSP-putki-liitäntä	1-1/2":n NPT tai BSP-putki-liitäntä	1":n NPT tai BSP-putki-liitäntä	1":n NPT tai BSP-putki-liitäntä
<b>Valinnaisvarusteet</b>	<ul style="list-style-type: none"> <li>• tehtaalla asennettu, ANSI-, DIN- ja JIS-standardeihin sopiva</li> <li>• polyeteleenivaahtopäällyste pölyisiä tai höyryisiä ympäristöjä varten</li> <li>• upotussuoja asennuksiin, joissa anturi voi joutua aineen sisään (ainoastaan XPS-10, XPS-15)</li> <li>• lukkolaippa prosessiasennukseen, ANSI-, DIN- ja JIS-standardeihin sopiva (ei saatavilla XPS-40-malliin)</li> </ul>					
<b>Kaapeli</b>	kaksijohtiminen kierretty parikaapeli/punottu ja kalvusuojuattu, 0,5 mm <sup>2</sup> (20 AWG), PVC-vaippa		<ul style="list-style-type: none"> <li>• kaksijohtiminen kierretty parikaapeli/punottu ja kalvusuojuattu, 0,5 mm<sup>2</sup> (20 AWG), PVC-vaippa</li> <li>• Suurin etäisyys: 100 m (330 ft)</li> </ul>		Silikonivaippa	
<b>Paino**</b>	0,8 kg (1,7 lb)	1,3 kg (2,8 lb)	4,3 kg (9,5 lb)	8 kg (18 lb)	0,8 kg (1,7 lb)	1,3 kg (2,8 lb)
<b>Suurin etäisyys</b>	365 m (1200 ft)	365 m (1200 ft)	365 m (1200 ft)	365 m (1200 ft)	365 m (1200 ft)	365 m (1200 ft)
<b>Teholähde</b>	Antureiden teholähteenä saa käyttää ainoastaan Siemens Milltronicsin sertifioituja ohjaimia.					
<b>Hyväksynnät</b>	CE***, CSA, FM, CENELEC/ATEX, INMETRO: Katso nimikivestä tai tiedustele Siemens Milltronicsilta voimassa olevat hyväksynnät.					

\* Yleislaippa, ANSI-, DIN- ja JIS-standardeihin sopiva.

\*\* Vakiopituusella kaapelilla varustetun anturin likimääräinen toimituspaino.

\*\*\* EMC-suorituskykyä koskevat tiedot saatavilla pyynnöstä.



# Muoto ja mitat

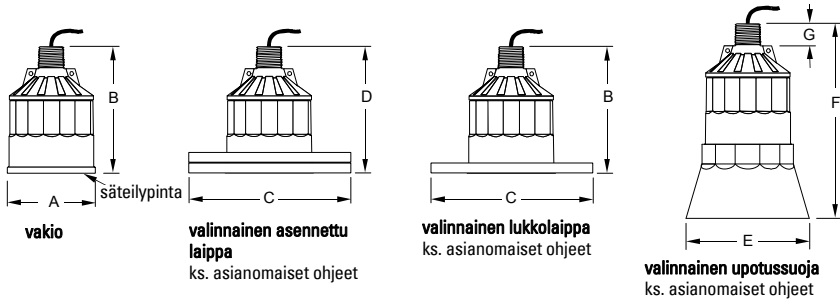

Mitat	XPS-10	XPS-15	XPS-30	XPS-40	XCT-8	XCT-12
A	88 mm (3,4")	121 mm (4,8")	175 mm (6,9")	206 mm (8,1")	88 mm (3,4")	121 mm (4,8")
B	122 mm (4,8")	132 mm (5,2")	198 mm (7,8")	229 mm (9,0")	122 mm (4,8")	132 mm (5,2")
C	ANSI-, DIN- ja JIS-standardeihin sopiva					
D*	128 mm (5,0")	138 mm (5,4")	204 mm (8,0")	235 mm (9,2")	128 mm (5,0")	138 mm (5,4")
E	124 mm (4,9")	158 mm (6,2")	ei koske	ei koske	ei koske	ei koske
F	152 mm (6,0")	198 mm (7,8")	ei koske	ei koske	ei koske	ei koske
G	28 mm (1,1")	28 mm (1,1")	28 mm (1,1")	28 mm (1,1")	28 mm (1,1")	28 mm (1,1")

\* nimellinen



**VAROITUS:** Valinnainen lukkolaippa, asennettu laippa ja Easy Aimer -kokoönpanot **eivät** sovellu painesovelluksiin.

## Asennus

**VAROITUS:** Anturia on käsiteltävä erittäin varovasti, ettei sen pinta vahingoitu.

- Asenna anturi niin, että se on **ainakin toimintatilan arvon verran aineen pinnan enimmäiskorkeuden yläpuolella**. Katso lisätietoja asianomaisen ohjaimen oppaasta.
- Nestesovelluksissa anturi on asennettava niin, että sen pinta on yhdensuuntainen nestepinnan kanssa. Käytä kiintoainesovelluksissa anturin kohdistamiseen Siemens Milltronics Easy Aimer -laitetta.
- Älä kiristä liian tiukkaan. Useimmissa sovelluksissa asennettavan laitteen kiristys käsin riittää. Varmista asennus yhdistämällä anturi turvaketjulla johonkin rakenneosaan. Muista valinnaisen **lämpötilan mittapään** käyttö laipallisen anturin, nopean lämpötilareagoitintarpeen ja kuumien säiliöiden yhteydessä.

**Huomautus:** Painetiivissä sovelluksissa antureita on asennettaessa kierrettävä käsinkiristykseen jälkeen vielä ½—1½ kierrosta. Painesovelluksissa kierteiden tiivistämiseen voidaan käyttää Teflon-nauhaa tai muuta sopivaa tiivistettä.

# Asennus – kiintoainesovellukset

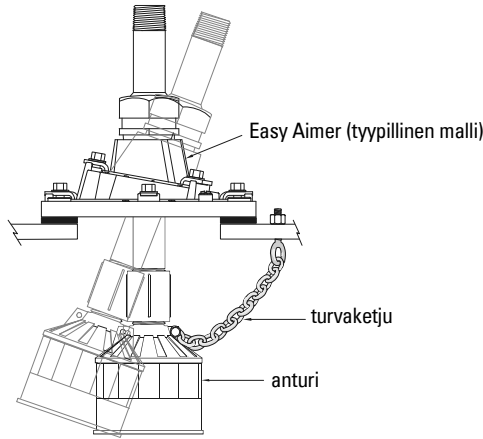

**VAROITUS:** Virheellinen asennus saattaa aiheuttaa prosessipaineen häviämisen.

# Asennus – nestesovellukset

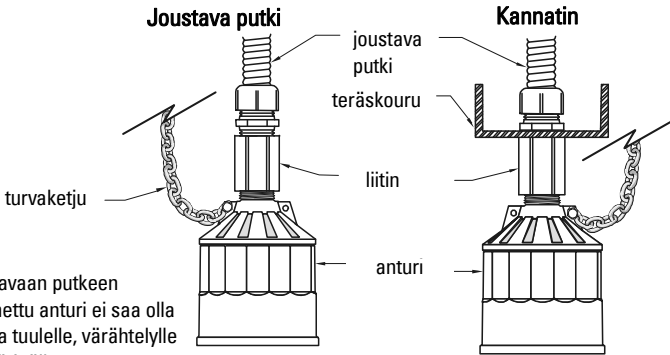

Joustavaan putkeen asennettu anturi ei saa olla alttiina tuulelle, värähtelylle eikä tärinälle.

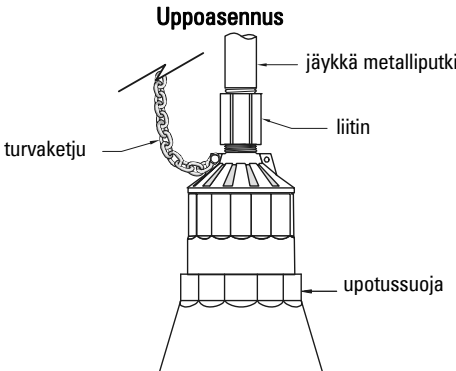

Upotussuojalla varustettu anturi soveltuksiin, joissa anturi voi jäädä aineen sisään.

## Vaneri

Vaneriasennus tarjoaa erinomaisen eristyksen, mutta sen on oltava riittävän jäykkä, ettei se taivu kuormitettuna.

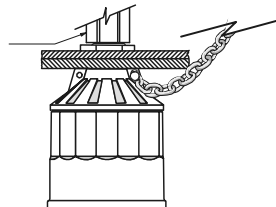

# Asennus – nestesovellukset (jatkoa)

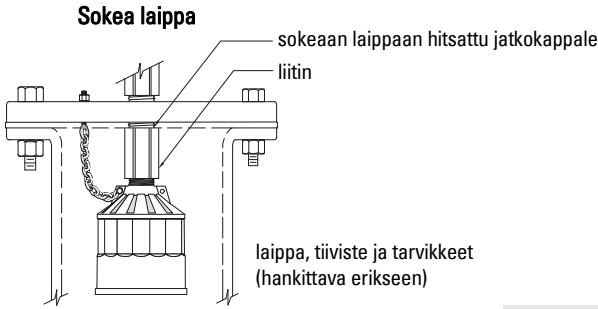

**Huomautus:** Kiristä laipan pultit tasaisesti, niin sovitettavat laipat asettuvat tiiviisti.

**HUOMIOITAVAA:** Liian tiukkaan kiristäminen voi heikentää suorituskykyä.

## Laippa-asennus

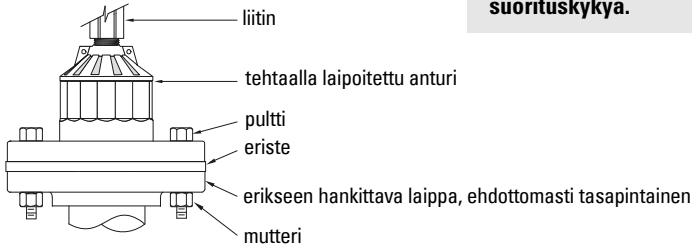

Erikseen laipoitettu pystyputki. Jos putkeen on hitsattava metallilaippa, katso ohjeet *Anturisolovellusten oppaan* kohdasta Nestesovellukset - Pystyputket.

# Asennus

---

**Huomautus:** Asennuksen saa suorittaa ainoastaan asiantunteva henkilöstö ja asennuksessa on noudatettava paikallisia määräyksiä.

- Älä vie kaapelia paljaana. Kaapeli eristetään tehokkaimmin sähköiseltä kohinalta viemällä se yksinään maadoitetussa metallijohdossa. Tiivistä kaikki kierrelitännät, ettei kosteus pääse asennukseen.
- Älä vie kaapelia lähelle suurjännite- tai virtajohtimia, kontakteja tai tyristoriohjaimia. Painetiivissä sovelluksissa antureita on asennettaessa kierrettävä käsinkiristykseen jälkeen vielä  $\frac{1}{2}$ — $1\frac{1}{2}$  kierrosta.
- Painesovelluksissa kierteiden tiivistämiseen voidaan käyttää Teflon-nauhaa tai muuta sopivaa tiivistettä.



**VAROITUS:** Älä yritä irrottaa, poistaa tai purkaa prosessiliitintä säiliön ollessa paineistettuna.

# Liitântä

## Suora liitântä

Liitä anturi suoraan Siemens Milltronics-lähetin-vastaanottiimeen kaksijohtimisella suojatulla kaapelilla.

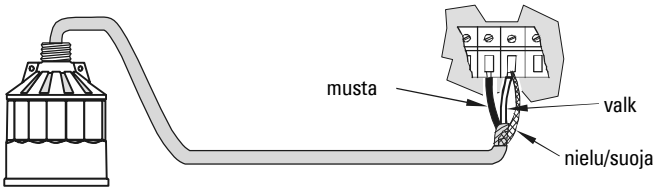

**Huomautus:** Liitettäessä anturia SITRANS LUT400 -, SITRANS LUC500 -, MultiRanger 100/200 - tai HydroRanger 200 -laitteeseen kaapelin musta johdin, valkoinen johdin ja suojausjohdin on kaikki liitettävä erikseen. ÄLÄ YHDISTÄ valkoista johdinta ja suojausjohdinta keskenään.

## Koaksiaaliliitântä

Liitä anturi Siemens Milltronics-lähetin-vastaanottimen käyttämällä asennusrasiaa ja RG-62 A/U -koaksiaalikaapelia. Tämä järjestely sopii yhdistelmäjohtotuksiin, joiden pituus on enintään 365 m (1200 ft).

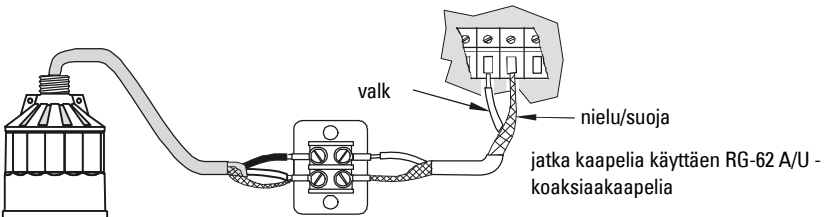

**Huomautus:** Liitettäessä anturia SITRANS LUT400 -, SITRANS LUC500 -, MultiRanger 100/200 - ja HydroRanger 200 -laitteisiin EI SAA käyttää koaksiaalikaapelia. Katso oikea menettely alla olevasta kaaviosta.

## Kaksijohtiminen jatke

(ainoastaan SITRANS LUT400, SITRANS LUC500, MultiRanger 100/200 ja HydroRanger 200)

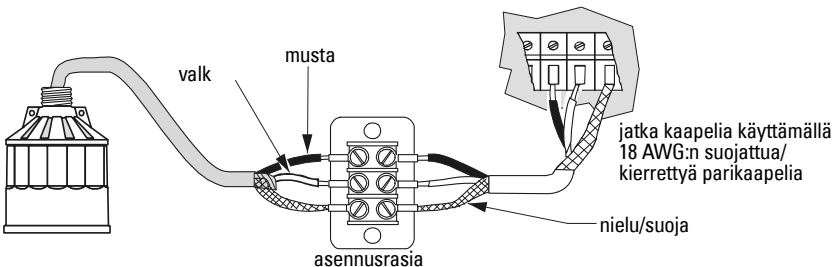



# Echomax XPS/XCT Användarmanual

Denna manual ger en översikt över de viktigaste egenskaperna och funktionerna för Echomax XPS/XCT transducererier. Denna manual, och *Transducer Tillämpnings Manual*, finns också tillgängliga på vår webbplats: [www.siemens.com/processautomation](http://www.siemens.com/processautomation). Tryckta kopior finns tillgängliga från din lokala representant för Siemens Milltronics.

**Frågor angående innehållet i denna manual kan sändas till:** Auktorerad representant för Europa

Siemens Milltronics Process Instruments  
1954 Technology Drive, P.O. Box 4225  
Peterborough, Ontario, Canada, K9J 7B1  
Email: [techpubs.smpi@siemens.com](mailto:techpubs.smpi@siemens.com)

Siemens AG  
Industry Sector  
76181 Karlsruhe  
Deutschland

## Copyright Siemens Milltronics Process Instruments 2013. Med ensamrätt

## Ansvarsbegränsning

Vi råder användare att skaffa sig auktoriserade inbundna handböcker, eller att konsultera av Siemens Milltronics Process Instruments. framtagna och utgivna elektroniska versioner. Siemens Milltronics Process Instruments ansvarar inte för innehållet i ofullständiga eller kompletta kopior av inbundna eller elektroniska versioner.

Trots att vi kontrollerat att innehållet i denna handbok överensstämmer med beskrivet materiel, kan avvikelser förekomma. Därför kan vi inte garantera full överensstämmelse. Innehållet i denna handbok revideras regelbundet och ändringar tas med i följande versioner. Vi välkomnar alla förslag till förbättringar. Tekniska data kan komma att ändras utan föregående varsel.

MILLTRONICS är ett registrerat varumärke för Siemens Milltronics Process Instruments

## Riktlinjer för säkerhet

Varningsnotiser måste efterlevas för att din personliga och andras säkerhet skall kunna säkras samt för att skydda produkten och ansluten utrustning. Dessa varningsnotiser åtföljs av anvisningar om den säkerhetsnivå som skall observeras.



**WARNING:** berör en varningssymbol på produkten. Den innebär att underlåtenhet att efterfölja de nödvändiga föreskrifterna kan orsaka dödsfall, svår kroppsskada och/eller stor materiell skada.



**WARNING:** innebär att underlåtenhet att efterfölja nödvändiga föreskrifter kan orsaka dödsfall, svår kroppsskada och/eller stor materiell skada.

**WARNING:** innebär att underlåtenhet att efterfölja nödvändiga föreskrifter kan orsaka stor materiell skada.

**Anmärkning:** innebär viktig information om produkten eller denna del av användarmanualen.

## Reparation och Ansvarsavsägelse

- Användaren är ansvarig för alla ändringar och reparationer som utförs på apparaten av användaren eller av användarens representant.
- Alla nya komponenter skall levereras av Siemens Milltronics Process Instruments Inc.
- Reparation skall endast omfatta reparation av felaktiga komponenter.
- Använd aldrig felaktiga komponenter på nytt.



**Denna produkt är avsedd för användning i industriområden. Drift av denna utrustning i ett bostadsområde kan förorsaka störningar av flera frekvensbaserade kommunikationer.**

Echomax XPS/XCT transducerserier fungerar med Siemens Milltronics produkter för monitoring av ultraljudsnivå.

Transducers omvandlar den elektriska transmissionspulsens från transceivern till akustisk energi. Den omvandlar sedan den akustiska energin från ekot tillbaka till elektrisk energi för kontrollören.

Transducerytan utsänder akustisk energi som strålar utåt, minskar i amplitud omvänt proportionellt mot kvadraten på avståndet. Maximal effekt utstrålar vinkelrätt från transducerytan på transmissionsaxeln. De punkter där effekten minskats till hälften ( $-3$  dB), utgör en konisk gränssyta som centreras runt transmissionsaxeln och definierar ljudstrålen vars diameter utgör ljudstrålens vinkel.

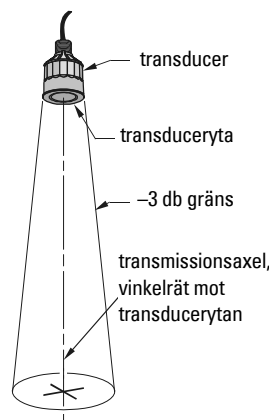

XPS/XCT transducers har en integrerad temperatursensor som återsänder värdet på lufttemperaturen vid transducern till kontrollören.

## Allmänna riktlinjer



**WARNING:** Konstruktionsmaterial väljs på basis av deras kemiska kompatibilitet (eller låga reaktionsbenägenhet) för allmänna ändamål. För exponering mot specifika omgivningar, kontrollera du mot kemiska kompatibilitetskort innan du installerar.

### XPS/XCT-serierna – Certifikat SIRA 99ATEX5153X

Denna utrustning kan användas i riskabla omgivningar med alla gaser i temperaturklasserna T1, T2, T3 och T4 för XPS-serierna (XPS-10, XPS-15, XPS-30, och XPS-40) och T1, T2, och T3 för XCT-serierna (XCT-8 och XCT-12). XPS-serierna certifieras endast för användning i rumstemperaturer i intervallet  $-40$  °C till  $95$  °C medan XCT-serierna endast certifieras för användning i rumstemperaturer i intervallet  $-40$  °C till  $145$  °C. Inga av dessa får användas utanför sina respektive temperaturintervall.

Installation skall utföras i enlighet med tillämpningsbar praxis, och av lämpligt utbildad personal.

Dessa apparater får endast försörjas från elkretsar försedda med säkring av lämplig kaliber med brytarkapacitet på  $4000$ A. Denna säkring inkluderas med Siemens Milltronics kontrollörer.

Reparation av denna utrustning skall utföras i enlighet med tillämplig praxis.

Tilldelning av certifikat för denna utrustning beror på vilka material som använts i dess konstruktion:

	XPS-serierna	XCT-serierna
Hölje	Kynar® 710	Kynar® 710
Inkapsling	Stycast LA-9823-76	Durapot® 861-F3 & 864

1. Kynar® är ett registrerat handelsmärke för ELF Atochem.  
Durapot® är ett registrerat handelsmärke för Cotronics Corporation.

För manuell kontroll använder du urkopplingskontakten, som finns med i uppsättningen av den associerade kontrollören.

### XPS 30/40-seriernana – Certifikat SIRA 01ATEX5153X

Denna utrustning kan användas i riskabla områden med hög dammhalt med alla sorters konduktiva och icke konduktiva dammsorter. The XPS-30 och XPS-40 typ av transducerserier har en maximal yttemperatur av 135 °C (275 °F) (Temperaturklass T4). Dessa enheter har certifikat för användning i rumsreperaturer på -40 till 95 °C (-40 till 203 °F). Dessa transducers får inte användas utanför detta temperaturområde. XPS-30 och XPS-40 ultraljudstransducers måste installeras så att transducerytan inte i högre grad blir utsatt för ljus.

Installation skall utföras i enlighet med tillämplig praxis, och av lämpligt utbildad personal. Reparation av utrustningen skall utföras i enlighet med tillämplig praxis och instruktioner för installation.

Dessa apparater får endast strömförsörjas från kretsar innehållande en säkring av lämplig kaliber med brytarkapacitet på 4000A. Denna säkring finns inkluderad i Siemens Milltronics kontrollörer.

Tilldelning av certifikat för denna utrustning beror på vilka material som använts i dess konstruktion:

Hölje:	Kynar® 710
Inkapsling:	Stycast LA-9823-76

För manuell kontroll använder du urkopplingskontakten, som finns med i uppsättningen av den associerade kontrollören.

### Produktmarkering

**Anmärkning:** Kynar® polyvinylidenfluorid motstår angrepp från de flesta kemikalier under de beskrivna användningsförhållandena. Beträffande exponering för specifika omgivningar, bör du emellertid kontrollera data för kemisk kompatibilitet innan installation sker.

**WARNING:** Denna produkt beskrivs som ett Tryckluftstillbehör enligt Direktiv 97/23/EC och är **inte** avsedd för användning som säkerhetsapparat.



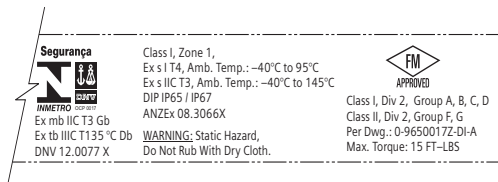
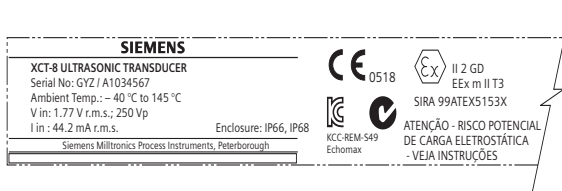



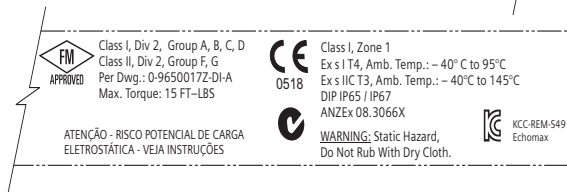

## XCT-12

**Anmärkning:**

- Nummer för produktkonfiguration visas endast som exempel.
- Serienummer visas endast som exempel.

## XPS-10

SIEMENS	
<b>XPS-10 ULTRASONIC TRANSDUCER</b> Serial No: GYZ / A1034567 Ambient Temp.: - 40 °C to 95 °C V in: 1.77 V r.m.s.; 250 Vp I in: 44.2 mA r.m.s.	Enclosure: IP66, IP68 Siemens Milltronics Process Instruments, Peterborough
 II 2 GD EEx m II T4 SIRA 99ATEX5153X Class I, Zone 1, Ex s IIIC T4 DIP IP65 / 67 ANZEx 08.3066X	  0518  KCC-REM-S49 Echomax

 Class I, Div 2, Group A, B, C, D Class II, Div 1, Group E, F, G Per Dwg.: 0-9650017Z-DI-A Max. Torque: 15 FT-LBS	<b>WARNING:</b> Static Hazard, Do Not Rub With Dry Cloth.	<b>Segurança</b>  Ex mb IIC T4 Gb Ex tb IIIC T135 °C Db DNV 12.0077 X
	<b>ATENÇÃO - RISCO POTENCIAL DE CARGA ELETROSTÁTICA - VEJA INSTRUÇÕES</b>	

## XPS-15

SIEMENS	
<b>XPS-15 ULTRASONIC TRANSDUCER</b> Serial No: GYZ / A1034567 Ambient Temp.: - 40°C to 95°C V in: 1.77 V r.m.s.; 250 Vp I in : 44.2 mA r.m.s.	Enclosure: IP66, IP68 Siemens Milltronics Process Instruments, Peterborough
 KCC-REM-S49 Echomax	  0518  II 2 GD EEx m II T4 SIRA 99ATEX5153X Class I, Zone 1, Ex s IIIC T4 DIP IP65 / 67 ANZEx 08.3066X



<b>Segurança</b>  Ex mb IIC T4 Gb Ex tb IIIC T135 °C Db DNV 12.0077 X	 Class I, Div 2, Group A, B, C, D Class II, Div 1, Group E, F, G Per Dwg.: 0-9650017Z-DI-A Max. Torque: 15 FT-LBS	<b>WARNING:</b> Static Hazard, Do Not Rub With Dry Cloth. <b>ATENÇÃO - RISCO POTENCIAL DE CARGA ELETROSTÁTICA - VEJA INSTRUÇÕES</b>
--	--	--

## Anmärkning:

- Nummer för produktkonfiguration visas endast som exempel.
- Serienummer visas endast som exempel.



## XPS-30

SIEMENS	
<b>XPS-30 ULTRASONIC TRANSDUCER</b> Serial No: GYZ / A1034567 Ambient Temp.: - 40 °C to 95 °C V in: 1.77 V r.m.s.; 250 Vp I in: 44.2 mA r.m.s. Enclosure: IP66, IP68 Siemens Milltronics Process Instruments, Peterborough	   Class I, Zone 1, Ex s IIIC T4 DIP IP65 / 67 ANZEx 08.3066X

Segurança	
 Ex mb IIC T4 Gb Ex tb IIIC T135 °C Db DNV 12.0077 X	 <b>WARNING:</b> Static Hazard, Do Not Rub With Dry Cloth. <b>ATENÇÃO - RISCO POTENCIAL DE CARGA ELETROSTÁTICA - VEJA INSTRUÇÕES</b>

## XPS-40

SIEMENS	
<b>XPS-40 ULTRASONIC TRANSDUCER</b> Serial No: GYZ / A1034567 Ambient Temp.: - 40 °C to 95 °C V in: 1.77 V r.m.s.; 250 Vp I in: 44.2 mA r.m.s. Enclosure: IP66, IP68 Siemens Milltronics Process Instruments, Peterborough	   Class I, Zone 1, Ex s IIIC T4 DIP IP65 / 67 ANZEx 08.3066X

Segurança	
 Ex mb IIC T4 Gb Ex tb IIIC T135 °C Db DNV 12.0077 X	 <b>WARNING:</b> Static Hazard, Do Not Rub With Dry Cloth. <b>ATENÇÃO - RISCO POTENCIAL DE CARGA ELETROSTÁTICA - VEJA INSTRUÇÕES</b>

### Anmärkning:

- Nummer för produktkonfiguration visas endast som exempel.
- Serienummer visas endast som exempel.

# Specifikationer

	XPS-10	XPS-15	XPS-30	XPS-40	XCT-8	XCT-12
<b>Mätningssområde</b>	0,3 - 10 m (1 - 33 ft)	0,3 - 15 m (1 - 50 ft)	0,6 - 30 m (2 - 100 ft)	0,9 - 40 m (3 - 130 ft)	0,6 - 8 m (2 - 26 ft)	0,6 - 12 m (2 - 40 ft)
<b>Frekvens (kHz)</b>	44	44	30	22	44	44
<b>Strålningsvinkel</b>	12°	6°	6°	6°	12°	6°
<b>Miljöbetingelser</b>						
<b>Placering</b>	inomhus/ utomhus	inomhus/ utomhus	inomhus/ utomhus	inomhus/ utomhus	inomhus/ utomhus	inomhus/ utomhus
<b>Maximal Höjd (m)</b>	2000	2000	2000	2000	2000	2000
<b>Omgivande Temperatur</b>	-40 till 95 °C (-40 till 203 °F)	-40 till 95 °C (-40 till 203 °F)	-40 till 95 °C (-40 till 203 °F)	-40 till 95 °C (-40 till 203 °F)	-40 till 145 °C (-40 till 293 °F)	-40 till 145 °C (-40 till 293 °F)
<b>Tryck</b>	8 bar (120 psi)	8 bar (120 psi)	Europa: 0,5 bar N. Amerika: 15 psi	Europa: 0,5 bar N. Amerika: 15 psi	8 bar (120 psi)	8 bar (120 psi)
<b>Nedsmuttningsgrad</b>	4	4	4	4	4	4
<b>Konstruktion</b>						
<b>Hölje</b>	PVDF	PVDF	PVDF	PVDF	<b>Standard:</b> PVDF <b>Optionell:</b> Fläns av universell* storlek finns tillgänglig med PTFE kontaktyta	
<b>Montering</b>	1" NPT eller BSP ledningsanslutning	1" NPT eller BSP ledningsanslutning	1-1/2" NPT eller BSP ledningsanslutning	1-1/2" NPT eller BSP ledningsanslutning	1" NPT eller BSP ledningsanslutning	1" NPT eller BSP ledningsanslutning
<b>Optioner</b>	<ul style="list-style-type: none"> <li>fabriksbundet för att passa ANSI, DIN, och JIS standardfordringar</li> <li>polyetylenkumplatta för dammiga eller ångmättade omgivelningar</li> <li>dränkningskydd, där översvämning kan hända (tillgängliga endast för XPS-10, XPS-15)</li> <li>splitfläns för fältmontering som passar ANSI, DIN, och JIS standardfordringar (ej tillgänglig för XPS-40)</li> </ul>					
<b>Kabel</b>	2-tråds tvinnat par/flätat och folieskärmat, 0,5 mm <sup>2</sup> (20 AWG), PVC-mantel		<ul style="list-style-type: none"> <li>2-tråds tvinnat par/flätat och folieskärmat, 0,5 mm<sup>2</sup> (20 AWG), PVC-mantel</li> <li><b>Maximal separation:</b> 100 m (330 ft)</li> <li>RG-62 A/U koax <b>Maximal separation:</b> 365 m (1200 ft)</li> </ul>		Silikonmantel	
<b>Vikt**</b>	0,8 kg (1,7 lb)	1,3 kg (2,8 lb)	4,3 kg (9,5 lb)	8 kg (18 lb)	0,8 kg (1,7 lb)	1,3 kg (2,8 lb)
<b>Maximal Separation</b>	365 m (1200 ft)	365 m (1200 ft)	365 m (1200 ft)	365 m (1200 ft)	365 m (1200 ft)	365 m (1200 ft)
<b>Elförsörjning</b>	Transducera får endast elförsörjas med Siemens Milltronics certifierade kontrollörer					
<b>Godkännanden</b>	CE***, CSA, FM, CENELEC/ATEX, INMETRO: Se namnplatta eller kontakta Siemens Milltronics för aktuella godkännanden.					

\* Universell fläns som passar ANSI, DIN, och JIS standardfordringar.

\*\* Approximativ transportvikt för transducer med standard kabellängd.

\*\*\* EMC prestanda tillgänglig på begäran.

# Översikt och dimensioner

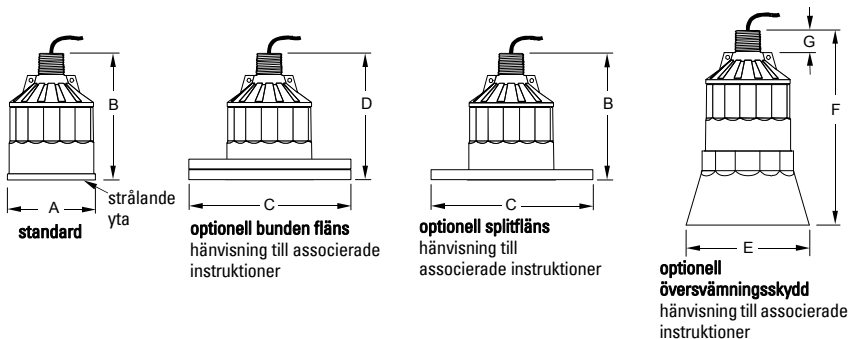

Dimension	XPS 10	XPS-15	XPS-30	XPS-40	XCT-8	XCT-12
A	88 mm (3,4")	121 mm (4,8")	175 mm (6,9")	206 mm (8,1")	88 mm (3,4")	121 mm (4,8")
B	122 mm (4,8")	132 mm (5,2")	198 mm (7,8")	229 mm (9,0")	122 mm (4,8")	132 mm (5,2")
C	för att passa till ANSI, DIN och JIS standardfordringar					
D*	128 mm (5,0")	138 mm (5,4")	204 mm (8,0")	235 mm (9,2")	128 mm (5,0")	138 mm (5,4")
E	124 mm (4,9")	158 mm (6,2")	n / a	n / a	n / a	n / a
F	152 mm (6,0")	198 mm (7,8")	n / a	n / a	n / a	n / a
G	28 mm (1,1")	28 mm (1,1")	28 mm (1,1")	28 mm (1,1")	28 mm (1,1")	28 mm (1,1")

\* nominell



**WARNING:** Optionell Splitfläns, Bunden fläns, och Easy Aimer-konfigurationer är inte lämpliga för trycktillämpningar.

## Montering

**WARNING:** Speciella hanteringsförberedelser måste tas för att skydda transducerns kontaktyta mot varje skada.

- Montera transducern så att den är **ovanför den maximala materialnivån med minst blankvärdet**. Studera den associerade kontrollörsmanualen.
- Vid tillämpningar på vätskor, monterar du transducerytan parallellt med vätskeytan. Vid tillämpningar på fasta material bör du använda en Siemens Milltronics Easy Aimer som hjälp till inriktning av transducern.
- Dra inte åt för hårt. De flesta tillämpningar behövs endast åtdragning med händerna för monteringshårdvaran. Anslut en säkerhetskedja från transducern till en del som ingår i strukturen för att säkra installationen. Överväg att använd den optionella **temperatursensorn** när en flänsförsedd transducer används, när ett snabbt temperatursvar behövs, eller kärl med hög temperatur.

**Anmärkning:** För trycktäta tillämpningar, installerar du transducerns handtätt åtdragna plus ½ varv till 1½ varv. PTFE tejp eller andra lämpliga tätningemedel kan användas som hjälp för isolering av gängorna för användning i trycktillämpningar.

## Montering – Tillämpningar med fasta ämnen

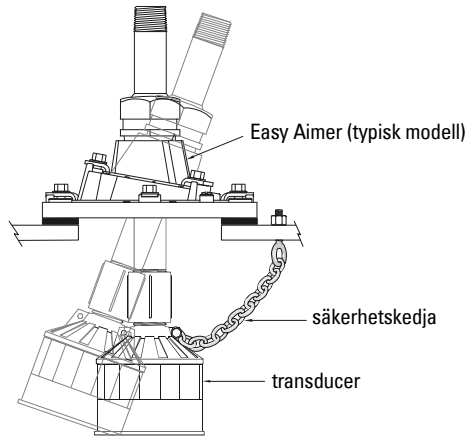

**WARNING:** Felaktig installation kan orsaka förlust av processtryck.

## Montering – Tillämpningar med vätskor

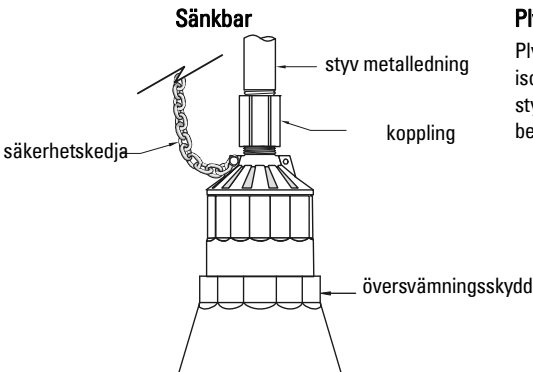
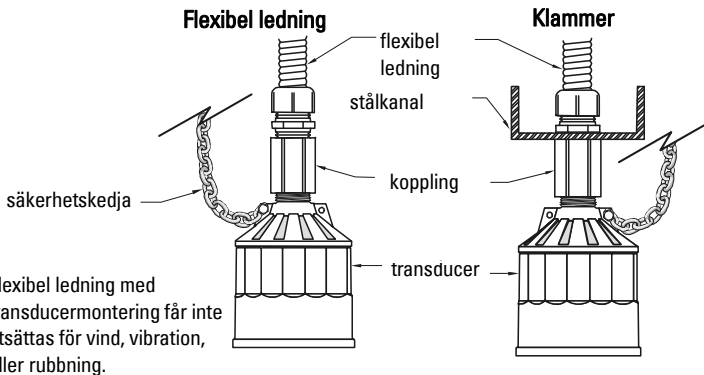

Transducer med dränkningskydd för användning i tillämpningar där översvämning kan inträffa.

### Plywood

Plywoodmontering ger utmärkt isolering, men måste vara tillräckligt styv så att den inte ger efter om den belastas.

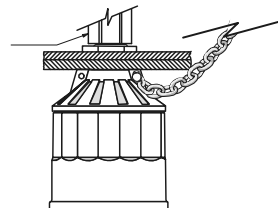



# Montering – Tillämpningar med vätskor (forts.)

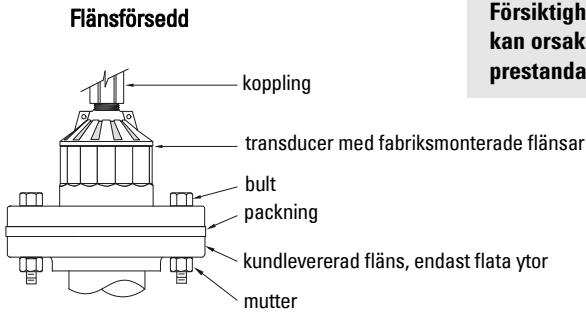
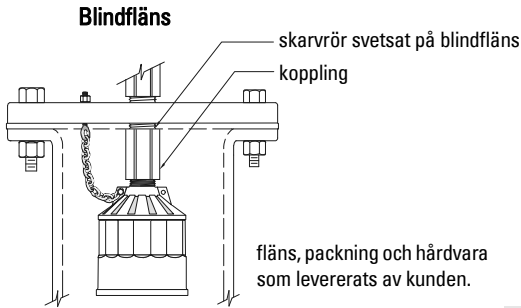

**Anmärkning:** Dra åt flänsbultarna jämt så att du säkerställer god tätning mellan motstående flänsar.  
**Försiktighet:** För hård åtdragning kan orsaka försämrade prestanda.

Kundens flänsförsedda ståndrör. Om en metallfläns måste svetsas på röret hänvisas till Tillämpningar med vätskor - Ståndrör i *Transducer Tillämpningsmanual*.

# Installation

---

**Anmärkning:** Installation får endast utföras av kompetent personal och enligt gällande lokala bestämmelser.

- Dra inte kabel i fria luften. För optimal isolering mot elektriskt brus drar du kabeln i jordad metalledning. Täta alla gängade anslutningar för att hindra fuktangrepp.
- Dra inte kabeln nära högspännings- eller starkströmsledning, kontaktorer och SCR kontrollmekanismer. För trycktäta tillämpningar, install transducers med handåtdragning plus  $\frac{1}{2}$  till  $1\frac{1}{2}$  varv.
- PTFE tejp eller annat lämpligt tätningsmedel kan användas för tätning av gängor som skall användas i trycktillämpningar.



**VARNING:** Försök inte att lossa, ta bort eller montera ned processanslutningar eller instrumenthöljet medan innehållet i kärlet står under tryck.

# Sammankoppling

## Direktkoppling

Anslut transducern direkt till Siemens Milltronics transceiver via den skärmade kabeln med två ledningar.

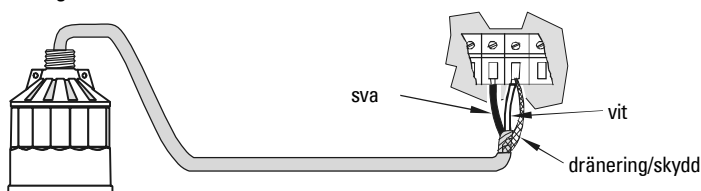

**Anmärkning:** När du ansluter till en SITRANS LUT400, en SITRANS LUC500, en MultiRanger 100/200, eller en HydroRanger 200, är den vita, svarta och skärmade ledningen separat anslutna. BIND INTE den vita och den skärmade ledningen tillsammans.

## Koaxialanslutning

Anslut transducern till Siemens Milltronics transceiver via en strömfördelare och RG-62 A/U koaxialkabel. Denna uppsättning är effektiv för kombinerade körningar upp till 365 m (1200 ft).

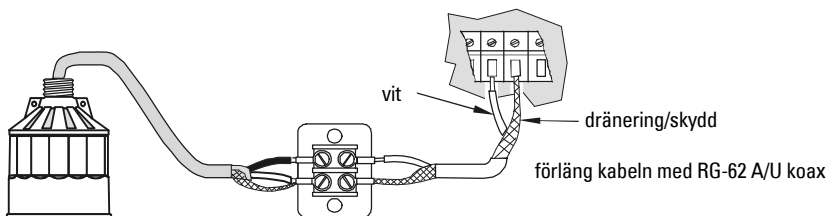

**Anmärkning:** När du ansluter på en SITRANS LUT400, SITRANS LUC500, MultiRanger 100/200 och HydroRanger 200 skall du INTE använda koaxialkabel; se diagrammet nedan för lämplig procedur.

## 2-tråds utsträckning

(endast för SITRANS LUT400, SITRANS LUC500, MultiRanger 100/200 och HydroRanger 200)

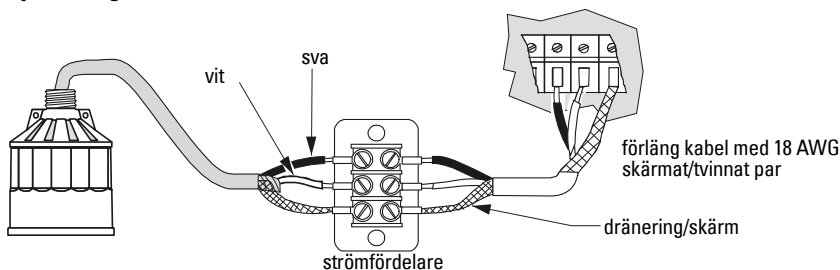



# Appendix A: Installation Diagrams

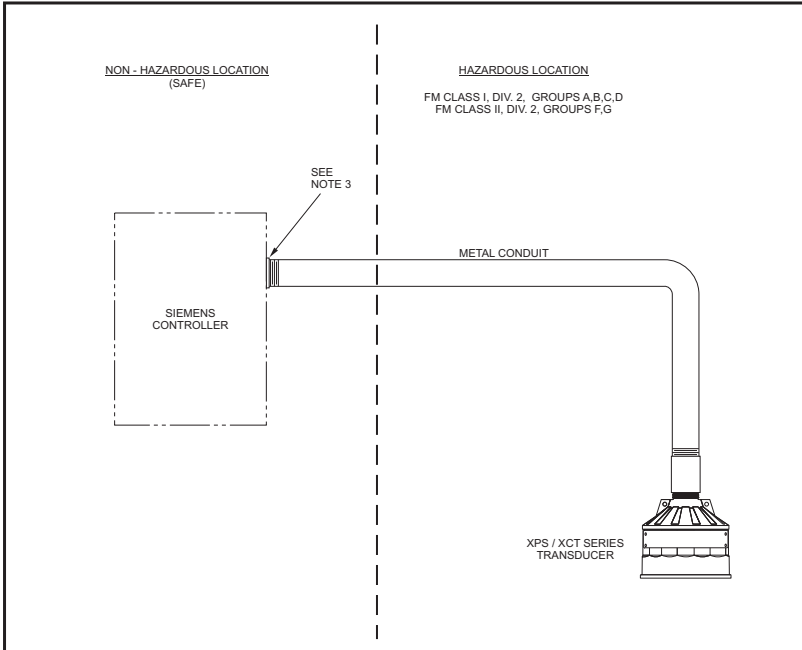

**NOTE:**

- 1) INSTALLATION SHALL BE DONE IN ACCORDANCE WITH THE NATIONAL ELECTRICAL CODE (N.E.C.)
- 2) NO REVISION SHALL BE MADE WITHOUT PRIOR FMRC AUTHORIZATION.
- 3) USE N.R.T.L. LISTED WATER TIGHT CONDUIT FITTING FOR OUTDOOR APPLICATIONS.

	1	REVISED TITLE BLOCK PER ECO P5A00004758 REMOVED MILLTRONICS REFERENCE.	PJF	MC	JULY 04/2012
USE DIMENSIONS ONLY - DO NOT SCALE	0	FOR ISSUE	BG	TV	AUG 13/1996
DIMENSIONS ARE IN INCHES	Rev.	Revision / ECN Description	Drawn	Appr.	Date
	Product Group:	ULTRASONICS	Tolerance Unless Otherwise Noted: UOS	Scale:	Size:
	Date:	13/AUG/1996	1 Place Decimal ± 0.03	NTS	A
SIEMENS CANADA LIMITED  SIEMENS MILLTRONICS PROCESS INSTRUMENTS  PETERBOROUGH, ONTARIO, CANADA	Drawn:	B. GRAY	2 Place Decimal ± 0.01	<b>TITLE:</b> XPS/XCT TRANSDUCER SERIES CONNECTION DIAGRAM	
	Checked:	S. NGUYEN	Angles: ± 0.5°		
	Approved:	TIEN VU	3 Place Decimal ± 0.002		
	Location:	PETERBOROUGH	<b>DRAWING No:</b> 0-9650017Z-DI-A		
	<b>FOR INTERNAL USE ONLY</b>		Rev.	1	
File No.	00055801	Plot at:	1 : 1	Sheet 1	Of 1

See Siemens Milltronics drawing number 0-9650017Z-DI-A for current drawing

# For Canadian Hazardous Installation Only

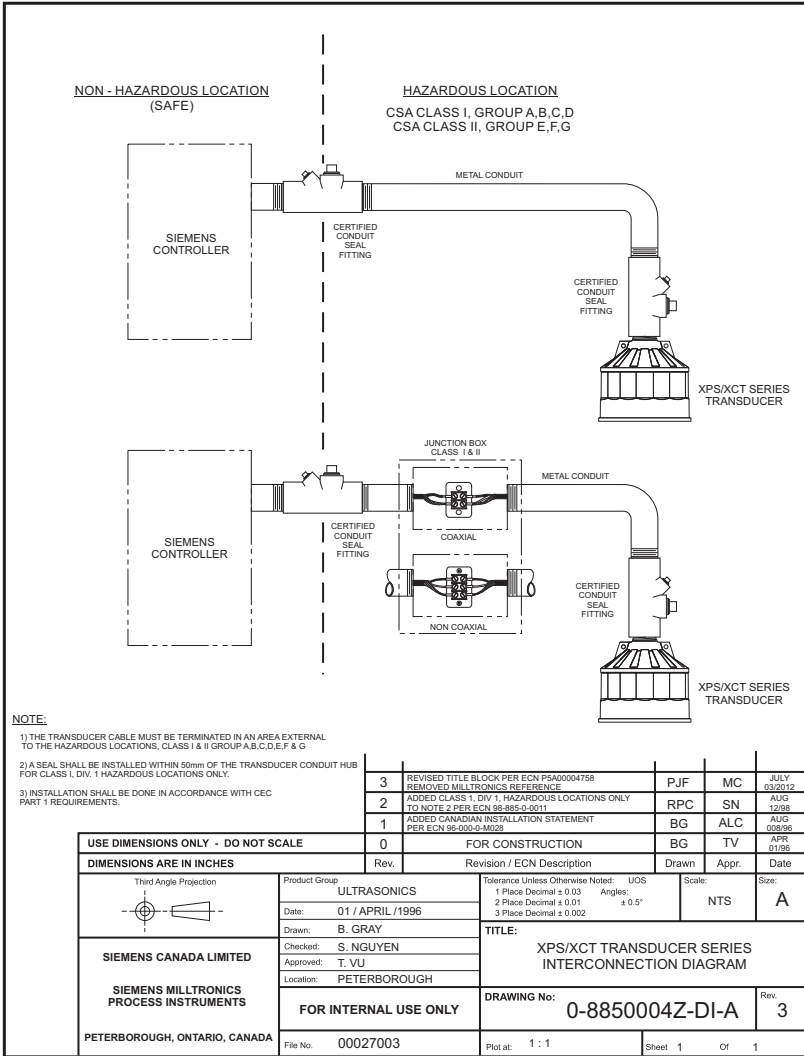

See Siemens Milltronics drawing number 0-8850004Z-DI-A for current drawing

## Unit Repair and Excluded Liability

All changes and repairs must be done by qualified personnel, and applicable safety regulations must be followed. Please note the following:

- The user is responsible for all changes and repairs made to the device.
- All new components must be provided by Siemens.
- Restrict repair to faulty components only.
- Do not re-use faulty components

## Reparation af enheden og ansvarsbegrænsning:

Alle ændringer og reparationer skal udføres af kvalificeret personale, og de gældende sikkerhedsbestemmelser skal overholdes. Bemærk venligst følgende:

- Brugeren er ansvarlig for alle de på apparatet udførte ændringer og reparationer.
- Alle nye komponenter skal være leveret af Siemens.
- Reparer kun defekte komponenter.
- Defekte komponenter må ikke genbruges

## Geräte Reparatur und Haftungsausschluss:

Alle Änderungen und Reparaturen müssen von qualifiziertem Personal unter Beachtung der jeweiligen Sicherheitsbestimmungen vorgenommen werden. Bitte beachten Sie:

- Der Benutzer ist für alle Änderungen und Reparaturen am Gerät verantwortlich.
- Alle neuen Bestandteile sind von Siemens bereit zu stellen.
- Reparieren Sie lediglich defekte Bestandteile.
- Defekte Bestandteile dürfen nicht wiederverwendet werden.

## Επισκευή μονάδας και αποκλειόμενη ευθύνη:

Όλες οι αλλαγές και οι επισκευές πρέπει να πραγματοποιούνται από εξειδικευμένο προσωπικό, και πρέπει να τηρούνται όλοι οι σχετικοί κανόνες ασφαλείας. Σημειώστε τα παρακάτω:

- Ο χρήστης είναι υπεύθυνος για όλες τις αλλαγές και επισκευές που γίνονται στη συσκευή.
- Όλα τα καινούργια εξαρτήματα πρέπει να παρέχονται από τη Siemens.
- Περιορίστε τις επισκευές μόνο στα ελαττωματικά εξαρτήματα.
- Μην επαναχρησιμοποιείτε ελαττωματικά εξαρτήματα.

## Reparación del dispositivo y límite de responsabilidad:

Las modificaciones y reparaciones deberán ser efectuadas por personal calificado de acuerdo con las normas de seguridad aplicables. Notas importantes:

- El usuario es el único responsable de las modificaciones y reparaciones del dispositivo.
- Recomendamos utilizar sólo recambios originales Siemens.
- Reparar sólo los componentes defectuosos.
- Los componentes defectuosos no se deben reutilizar.

## Réparation de l'unité et limite de responsabilité :

Les modifications et réparations doivent être effectuées par un personnel qualifié en accord avec les consignes de sécurité applicables.

Remarques importantes :

- L'utilisateur est seul responsable des modifications et réparations effectuées sur l'unité.
- Utiliser seulement des composants fournis par Siemens.
- Réparer uniquement les composants défectueux.
- Les composants défectueux ne doivent pas être réutilisés.

## Riparazioni dell'apparecchiatura e limiti di responsabilità:

Le modifiche e le riparazioni devono essere effettuate solo da personale qualificato, rispettando le normative sulla sicurezza. Note importanti:

- L'utente è responsabile delle eventuali modifiche e riparazioni effettuate sull'apparecchiatura.
- Utilizzare solo pezzi di ricambio originali forniti da Siemens.
- Riparare solo i componenti difettosi.
- È importante non riutilizzare i componenti difettosi.

## Reparatie van apparatuur en uitsluiting van aansprakelijkheid:

Alle modificaties en reparaties moeten worden uitgevoerd door gekwalificeerd personeel en de geldende veiligheidsvoorschriften moeten worden aangehouden. Let op:

- De gebruiker is verantwoordelijk voor alle modificaties en reparaties die worden uitgevoerd aan het apparaat.
- Alle nieuwe onderdelen moeten zijn geleverd door Siemens.
- Beperk de reparatie uitsluitend tot de defecte componenten.
- Defecte componenten niet opnieuw gebruiken.

## Reparação da Unidade e Responsabilidade Excluída

Todas as alterações e reparações devem ser realizadas por pessoal qualificado e devem ser seguidas as regras de segurança aplicáveis. Por favor, note o seguinte:

- O usuário é responsável por todas as alterações e reparos efetuados no dispositivo.
- Todos os novos componentes devem ser fornecidos pela Siemens.
- Reparo restrito a apenas a componentes danificados.
- Não reutilize componentes danificados.

## Yksikön korjaaminen ja vastuuvapaus:

Muutos- ja korjaustyöt saa suorittaa ainoastaan pätevä henkilökunta, ja voimassa olevia turvallisuusmääräyksiä on noudatettava. Pyydämme ottamaan huomioon seuraavat seikat:

- Käyttäjän on vastuussa kaikista laitteeseen tehdyistä muutoksista ja korjauksista.
- Kaikki uudet osat on hankittava Siemens:iltä.
- Korjaukset on kohdistettava ainoastaan viallisiin osiin.
- Viallisia osia ei saa käyttää uudelleen.

## Reparation och ansvarfrihet:

Alla ändringar och reparationer måste utföras av kompetent personal och under iakttagande av gällande säkerhetsbestämmelser. Observera att:

- Användaren ansvarar för alla ändringar och reparationer som görs på enheten.
- Alla nya delar måste komma från Siemens.
- Reparera endast med fel behäftade delar.
- Delar behäftade med fel får ej återanvändas.

## For more information

[www.siemens.com/level](http://www.siemens.com/level)

[www.siemens.com/continuous-weighing](http://www.siemens.com/continuous-weighing)

Siemens AG  
Industry Sector  
1954 Technology Drive  
P.O. Box 4225  
Peterborough, ON  
Canada K9J 7B1

email: [techpubs.smpi@siemens.com](mailto:techpubs.smpi@siemens.com)

[www.siemens.com/processautomation](http://www.siemens.com/processautomation)

Subject to change without prior notice  
A5E3228289 Rev. AA

© Siemens AG 2013



A 5 E 3 2 2 8 2 8 8 9  
Printed in Canada