



million  
in one

**sitrans**

LU01

**SIEMENS**

**Safety Guidelines:** Warning notices must be observed to ensure personal safety as well as that of others, and to protect the product and the connected equipment. These warning notices are accompanied by a clarification of the level of caution to be observed.

**Qualified Personnel:** This device/system may only be set up and operated in conjunction with this manual. Qualified personnel are only authorized to install and operate this equipment in accordance with established safety practices and standards.

**Unit Repair and Excluded Liability:**

- The user is responsible for all changes and repairs made to the device by the user or the user's agent.
- All new components are to be provided by Siemens Milltronics Process Instruments Inc.
- Restrict repair to faulty components only.
- Do not reuse faulty components.

**Warning:** This product can only function properly and safely if it is correctly transported, stored, installed, set up, operated, and maintained.

**This product is intended for use in industrial areas. Operation of this equipment in a residential area may cause interference to several frequency based communications.**

**Note:** Always use product in accordance with specifications.

<b>Copyright Siemens Milltronics Process Instruments Inc. 2008. All Rights Reserved</b>	<b>Disclaimer of Liability</b>
This document is available in bound version and in electronic version. We encourage users to purchase authorized bound manuals, or to view electronic versions as designed and authored by Siemens Milltronics Process Instruments Inc. Siemens Milltronics Process Instruments Inc. will not be responsible for the contents of partial or whole reproductions of either bound or electronic versions.	While we have verified the contents of this manual for agreement with the instrumentation described, variations remain possible. Thus we cannot guarantee full agreement. The contents of this manual are regularly reviewed and corrections are included in subsequent editions. We welcome all suggestions for improvement.  Technical data subject to change.

MILLTRONICS® is a registered trademark of Siemens Milltronics Process Instruments Inc.

**Contact SMPI Technical Publications at the following address:**

Technical Publications  
Siemens Milltronics Process Instruments Inc.  
1954 Technology Drive, P.O. Box 4225  
Peterborough, Ontario, Canada, K9J 7B1  
Email: [techpubs.smpi@siemens.com](mailto:techpubs.smpi@siemens.com)

**European Authorized Representative**

Siemens AG  
Industry Sector  
76181 Karlsruhe  
Deutschland

- For a selection of Siemens Milltronics level measurement manuals, go to: **[www.siemens.com/processautomation](http://www.siemens.com/processautomation)**. Under Process Instrumentation, select *Level Measurement* and then go to the manual archive listed under the product family.
- For a selection of Siemens Milltronics weighing manuals, go to: **[www.siemens.com/processautomation](http://www.siemens.com/processautomation)**. Under Weighing Technology, select *Continuous Weighing Systems* and then go to the manual archive listed under the product family.

# Table of Contents

---

<b>Introduction</b> .....	1
SITRANS LU01 .....	1
SITRANS LU01 Features .....	3
Programmable Features .....	3
The Manual .....	4
<b>Specifications</b> .....	5
Electronics .....	5
Programmer .....	6
Transducer .....	7
Options .....	7
Cable .....	7
Safety marking symbols .....	8
<b>Installation</b> .....	9
SITRANS LU01 .....	9
Location .....	9
Cable/Conduit Entry Requirements .....	9
Mounting .....	10
Transducer Mounting .....	10
Interconnection .....	11
Optional SmartLinX Module .....	13
System Diagram .....	14
Transducer .....	14
Temperature Sensor .....	15
Relays .....	15
mA Outputs .....	15
Communication .....	16
Serial .....	16
SmartLinX .....	16
Level System Synchronization .....	16
Power .....	17
AC Supply Wiring .....	17
DC Supply Wiring .....	17
Programmer .....	18
Communications Access .....	18
<b>Programming</b> .....	19
Display .....	19
Keypad .....	20
Program Mode Entry .....	21
Changing Parameters .....	21
Parameter Reset Features .....	22
Parameters Types .....	22
Programming Security .....	22

<b>Operation</b> .....	23
Display in RUN Mode .....	23
Keypad .....	24
System Performance Evaluation .....	25
Performance Test Results .....	25
<b>Parameter Reference</b> .....	27
Helpful Hints .....	27
Parameter Reset Features .....	28
Programming Security .....	28
Quick Start (P001 to P007) .....	29
Application Parameters .....	32
Volume (P050 to P055) .....	32
Display and Reading (P060 to P062) .....	36
Failsafe (P070 to P072) .....	37
Relays (P100 to P119) .....	39
Custom Relays (P111 to P113) .....	42
Independent Relay Setpoints .....	43
Independent Relay Failsafe (P129) .....	46
mA Output (P200 to P219) .....	47
Independent mA Setpoints (P210 and P211) .....	48
mA Output Limits (P212 and P213) .....	48
mA Output Trim (P214 to P215) .....	49
mA Output Failsafe (P219) .....	50
Standard Data Logging (P300 to P321) .....	50
Record Temperatures (P300 to P303) .....	50
Profile Records (P330 to P337) .....	51
Auto Record ON and OFF Setpoints (P334 to P337) .....	52
Installation Records (P340 to P342) .....	54
Range Calibration (P650 to P654) .....	54
Temperature Compensation (P660 to P664) .....	57
Rate (P700 to P707) .....	58
Measurement Verification (P710 to P713) .....	60
Transducer Scanning (P725 to P729) .....	62
Display (P730 to P733) .....	63
Peripheral Communication Support Parameters (P740 to P749) .....	65
SmartLinX Reserved (750 to 769) .....	65
Communications (P772) .....	66
SmartLinX Hardware Testing .....	66
Echo Processing (P800 to P807) .....	67
Advanced Echo Processing (P810 to P825) .....	70
Profile Pointer (P817 to P825) .....	72
Advanced TVT Adjustment (P830 to P835) .....	75
Advanced Shot Adjustment (P840 to P852) .....	78
Test (P900 to P913) .....	80
Measurement (P920 to P927) .....	83
<b>Technical Reference</b> .....	85
Transmit Pulse .....	85
Echo Processing .....	85

Echo Processing Displays (Scope Displays, P810) .....	86
Dolphin Plus Display .....	86
Distance Calculation .....	86
Sound Velocity .....	86
Volume Calculation .....	87
Universal, Linear (P050 = 9) .....	87
Universal, Curved (P050 = 10) .....	88
Maximum Process Speed .....	88
Application Examples .....	89
Example 1 - Level Measurement .....	90
Material Volume .....	92
Example 2 - Space Measurement .....	92
Application Assistance .....	94
Communication Support .....	94
MT-00 Measurement Message .....	95
MT-01 Hold Message .....	96
MT-03 Point Not Scanned .....	97
<b>Maintenance</b> .....	<b>98</b>
Unit Repair and Excluded Liability .....	98
<b>Troubleshooting Guide</b> .....	<b>99</b>
Measurement Difficulties .....	100
Flashing LOE Display .....	100
Fixed Reading .....	101
Wrong Reading .....	102
<b>Programming Charts</b> .....	<b>104</b>



# Introduction

## SITRANS LU01

**Note:**

- The SITRANS LU01 is to be used only in the manner outlined in this instruction manual.
- This product is intended for use in industrial areas. Operation of this equipment in a residential area may cause interference to several frequency based communications.

The SITRANS LU01 is an ultrasonic long-range level monitoring system for liquids and solids. SITRANS LU01 level monitor uses one Siemens Milltronics ultrasonic transducers (ordered separately) to accurately monitor material levels without material contact.

The SITRANS LU01 transmits electronic pulses to each connected ultrasonic transducer. The transducer converts the electronic pulses to ultrasonic pulses which are emitted from the transducer face in a narrow beam. The SITRANS LU01 measures the time from the pulse emission, to reception of the reflection (echo) from the material. Using the time measured, the SITRANS LU01 calculates the distance from the transducer face to the material.

The distance calculation depends upon the sound velocity within the vessel. When an Echomax transducer is used, variable air temperatures are automatically compensated. For superior air temperature compensation, a Siemens Milltronics TS-3 temperature sensor may be used for each vessel. A simple calibration feature compensates for homogeneous atmospheres other than air.

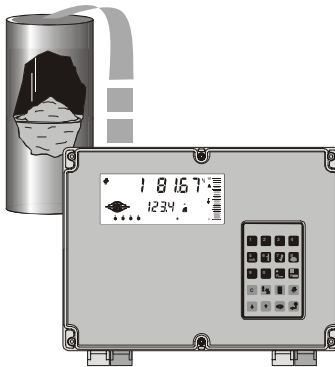

The SITRANS LU01 uses Siemens Milltronics patented Sonic Intelligence<sup>®</sup> echo processing. Sonic Intelligence provides high measurement reliability, regardless of changing conditions within the vessel monitored. By using ultrasonic echo ranging principles with Sonic Intelligence and velocity compensation, the SITRANS LU01 provides outstanding measurement accuracy, usually within 0.25% of range.

The distance calculation can be converted to space, material level, material volume, or remaining vessel capacity. The reading chosen (and operating data) for each vessel is displayed on the LCD (liquid crystal display).

The relays and mA outputs may be used as preset (or programmed as desired) to activate alarms and/or operate remote monitoring equipment and/or process control equipment.

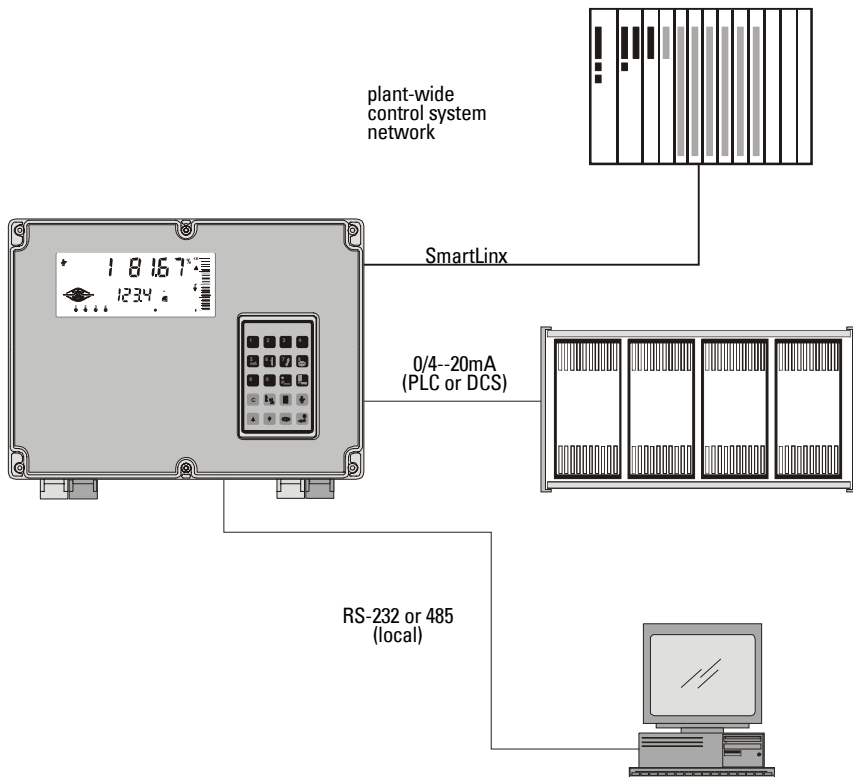

With the addition of a Siemens Milltronics Smartlinx<sup>®</sup> protocol specific plug-in communications module, the SITRANS LU01 is compatible with popular industrial control system standards. Supported protocols include PROFIBUS DP, Allen-Bradley<sup>®</sup> 1 Remote I/O, Modbus<sup>®</sup> RTU, and DeviceNet<sup>™</sup>.

Programming can be done locally using the portable programmer keypad, or remotely through optional Dolphin Plus software or SmartLinx.

- The programmer transmits the keypad entries via infrared link to the SITRANS LU01, and can be removed when not in use.
- Dolphin Plus allows programming either through the RJ-11 port or hardwired via the RS-232/485 communication port.

1. Allen-Bradley is a registered trademark of Rockwell Automation. Modbus is a registered trademark of Schneider Electric. DeviceNet is a trademark of ODVA (Open DeviceNet Vendor Association).



- SmartLinx provides protocol specific hardware and software for interface with popular industrial communication systems.

The SITRANS LU01 is typically used to monitor material level in open or closed vessels but can be used in almost any process which requires a distance measurement (within the system range).

Refer to Technical Reference Application Examples on page 89 for detailed descriptions of some configuration examples to which the SITRANS LU01 may be applied.

## SITRANS LU01 Features

- **Enclosure:** Chemical resistant, light weight, dust tight, liquid tight, easy to work with.
- **Backlit LCD:** Large digits for Reading and programming value displays. Illuminated LCD insures readability under all lighting conditions. Includes custom Graphic Symbols for continuous indication of operating conditions.
- **Programmer:** 20 tactile feedback keys for easy access to programming and operating functions. Magnetic mounting and infrared interface permit removal on programming completion.
- **Communications:** SmartLinx Compatible  
Communications ready when equipped with an appropriate Siemens Milltronics SmartLinx module.
- **Dolphin Compatible Communications**  
Dolphin Plus is Windows<sup>®</sup> 1-compatible configuration software connected to the unit via the RG-11 port or remote connection through the RS-232 or RS-485 port. The software provides an easy means for programming, uploading, or downloading parameters.
- **Speed:** 16/32 bit microprocessor at 16.7 MHz clock speed. 1 vessel (point) per second scanning speed capability.
- **Reliability:** Sonic Intelligence ensures all measurements are accurate and reliable. Immune to power interruptions. All programming is stored indefinitely. Dynamic operating data is retained for one hour and updated immediately on power resumption.

## Programmable Features

The SITRANS LU01 is easy to program, yet versatile enough to handle complex level measurement requirements.

### General Features

- *Direct Access:* Any operator programmable feature may be accessed directly.
- *Scroll Access:* Scroll forward, scroll back, to key features.
- *Operation:* Select level, space, or distance operation.

---

<sup>1</sup> Windows is a registered trademark of Microsoft Corporation.

- *Material:* Liquid or solid; automatically adjusts echo processing with one entry.
- *Response:* Slow, medium, fast, surge, or immediate response to material level changes.
- *Units:* Display Readings in m, cm, mm, ft, in, %, or any other units desired.
- *Volume:* 8 pre-programmed tank shape options. 2 universal tank shape programming methods
- *Failsafe:* Failsafe options for process control equipment activation.
- *Relays:* 8 functions including level, rate of change, pump control, temperature and more.  
Fixed or independent on/off setpoints
- *mA Outputs:* Based on level, space, distance, or volume. There are 4 range selections: 0-20, 4-20, 20-0, or 20-4 mA with an adjustable range and over-range limits

## The Manual

The manual is designed to help you get the most out of your SITRANS LU01, and it provides information on the following:

- |   |                           |
|---|---------------------------|
| • Product specifications                        | • Principles of operation |
| • Outline diagrams                              | • Parameter values        |
| • Wiring diagrams                               | • Technical Reference     |
| • Installation and interconnection requirements | • Example applications    |
| • How to program the unit                       | • Troubleshooting guide   |
|   | • Programming chart       |

If you have any questions, comments, or suggestions about the manual contents, please e-mail us at [techpubs.smpi@siemens.com](mailto:techpubs.smpi@siemens.com).

For the complete library of Siemens Milltronics manuals, go to [www.siemens.com/processautomation](http://www.siemens.com/processautomation)

### REMEMBER!

Fill out Programming chart on page 104 or record parameters using Dolphin Plus.

# Specifications

---

## Electronics

### Power

- AC model: 100/115/200/230 V AC  $\pm 15\%$ , 50/60 Hz, 31 VA
- DC model: 18 to 30 V DC, 25 W

### Environmental

- location indoor / outdoor
- altitude 2000 m max
- ambient temperature  $-20$  to  $50$  °C ( $-5$  to  $122$  °F)
- relative humidity suitable for outdoor (Type 4X / NEMA 4X / IP65 enclosure)
- installation category II
- pollution degree: 4

### Scan Points

- 1 point per SITRANS LU01 max.
- frequency independent

### Range

- Level Measurement: 0.3 m (1 ft) to 60 m (200 ft) max.

### Accuracy

- 0.25% of range or 6 mm (0.24"), whichever is greater

### Resolution

- 0.1% of program range<sup>1</sup> or 2 mm (0.08"), whichever is greater

### Memory

- EEPROM (non-volatile) no back-up battery required

### Programming

- via removable programmer or optional Dolphin Plus software

### Display

- custom graphics backlit LCD with 51 mm (2 in) x 127 mm (5 in) viewing area

### Synchronization:

- up to 16 SITRANS LU01 units can be synchronized together

### Temperature Compensation

- $-50$  to  $150$  °C ( $-58$  to  $302$  °F)
- integral temperature sensor in transducer
- TS-3 temperature sensor
- programmable fixed temperature

### Temperature Error

- with compensation: 0.09% of range
- fixed temperature: 0.17% / °C deviation from programmed temperature.

---

<sup>1</sup> program range is defined as the empty distance to the face of the transducer (P006) plus any range extension (P801).

## Outputs

- relays: 4 alarm/control relays  
1 form "C" SPDT contact per relay, rated 5 A at 250 V AC, non-inductive
- analog: 1 output max.  
0.1% resolution  
0-20 or 4-20 mA, scalable  
750  $\Omega$ , isolated, 30V rms

## Communications (see Options)

- SmartLinX compatible
- RS-232 / 485 port
- Dolphin Plus compatible
- proprietary bipolar current loop

## Enclosure

- Type 4X / NEMA 4X / IP65 <sup>1</sup>
- 285 mm W x 209 mm H x 92 mm D (11.2" W x 8.2" H x 3.6" D)
- polycarbonate

## Weight

- 2.7 kg (6 lb)

## Approvals

- See device nameplate.

# Programmer

## Ambient Temperature

- -20 to 50 °C (-5 to 122 °F)

## Keypad

- 20 keys with tactile feedback

## Interface

- non-invasive, digital, infra-red

## Enclosure

- general purpose
- 67 mm W x 100 mm H x 25 mm D (2.6" W x 4" H x 1" D)
- ABS plastic

## Weight

- 150 g (0.3 lb)

---

<sup>1</sup> The use of approved watertight hubs/glands is required for Type 4X / NEMA 4X, IP65 on watertight applications.

# Transducer

## Compatible Models

- STH and Echomax<sup>®</sup> series
- Refer to the associated instruction manual.

## Options

### Temperature Sensor

- TS-3

### SmartLinx Modules

- Supported protocols: PROFIBUS DP  
Allen-Bradley<sup>®</sup> 1 Remote I/O  
Modbus<sup>®</sup> RTU  
DeviceNet<sup>™</sup>

### Dolphin Plus

- Windows<sup>®</sup> -compatible configuration software connected to the unit via infrared Converter link  
*Refer to associated product documentation.*

## Cable

### Transducer

- RG-62 A/U (or equivalent), 365 m (1,200 ft) max.  
See transducer instructions for short extensions (in grounded metal conduit, separate from other wiring)

### mA Output

- Belden 8760, shielded / twisted pair, 18 AWG (0.75 mm<sup>2</sup>) or equivalent or Belden 9552, shielded / two twisted pair, 18 AWG (0.75 mm<sup>2</sup>)
- maximum separation 1,500 m (5,000 ft)

### Synchronisation

- Belden 8760, shielded / twisted pair, 18 AWG (0.75 mm<sup>2</sup>) or equivalent

### Relays

- No shielded cable necessary

### Temperature sensor

- Belden 8760 shielded / twisted pair, 18 AWG (0.75 mm<sup>2</sup>) or equivalent
- 365 m (1,200 ft) per TS-3 maximum

### RJ11 Link

- No shielded cable necessary
- maximum length 3 m (10 ft)

---

<sup>1</sup> Allen-Bradley is a registered trademark of Rockwell Automation. Modbus is a registered trademark of Schneider Electric. DeviceNet is a trademark of ODVA (Open DeviceNet Vendor Association).

## RS-232 Link

- Belden 8770, 3 conductor/shielded, 18 AWG (0.75 mm<sup>2</sup>) or equivalent
- maximum separation 15 m (50 ft)







## RS-485 Link

- Belden 8770, 3 conductor/shielded, 18 AWG (0.75 mm<sup>2</sup>) or equivalent
- maximum separation 1200 m (4000 ft)

## SmartLinx module

- refer to the associated instruction manual.

## Safety marking symbols

In manual	On Product	Description
		(Label on product: yellow background.) Caution: refer to accompanying documents (manual) for details.
		Alternating Current
		Direct Current
		Earth (ground) Terminal
		Protective Conductor Terminal

# Installation

---

Installation shall only be performed by qualified personnel, and in accordance with local governing regulations.

The following procedure applies to all SITRANS LU01 level monitor installations. See Application Examples on page 89 for additional installation requirements. Also, refer to the instruction manuals of all other equipment connected to the SITRANS LU01 for additional installation instructions.

## SITRANS LU01

### Location

#### Recommended

- Ambient temperature is always within -20 to 50 °C (-5 to 122 °F)
- SITRANS LU01 display window is at shoulder level, unless most interaction is through a SCADA system
- Easy access for hand programmer is provided
- Cable length requirements are minimal
- Mounting surface is free from vibration
- Leave sufficient room to swing unit lid open and have clear access.
- A place for a laptop computer is provided for on-site Dolphin Plus configuration

#### Avoid

- Exposure to direct sunlight. (Provide a sun shield to avoid direct sunlight.)
- Proximity to high voltage/current runs, contacts, SCR or variable frequency motor speed controllers

### Cable/Conduit Entry Requirements

Enclosure cable/conduit entries may be required for:

- Transducers
- TS-3 temperature sensor (if used)
- mA output (if used)
- Relays (if used)
- Synchronization (see Interconnection/Level System Synchronization)
- Power
- Communications: SmartLinX, RS-485, RS-232, bipolar.

**Note:** Transducer cables must be run in a grounded metal conduit, separate from other wiring, (except TS-3 temperature sensor wiring, if applicable).

# Mounting

Inspect all cartons and packaging for possible damage during shipment, before removing the SITRANS LU01 and associated equipment.

1. Loosen the 6 enclosure lid (captivated) screws and swing the lid open.
2. Remove the 4 Board B mounting screws (outer corners) and remove the circuit board assembly.
3. Drill required holes in the enclosure bottom to meet enclosure cable/conduit entry requirements.
4. Attach the enclosure to the selected mounting surface (use four predrilled screw holes).
5. Attach the conduits/cable hubs to the enclosure. (Do not apply undue force.)
6. Reinstall the circuit board assembly.

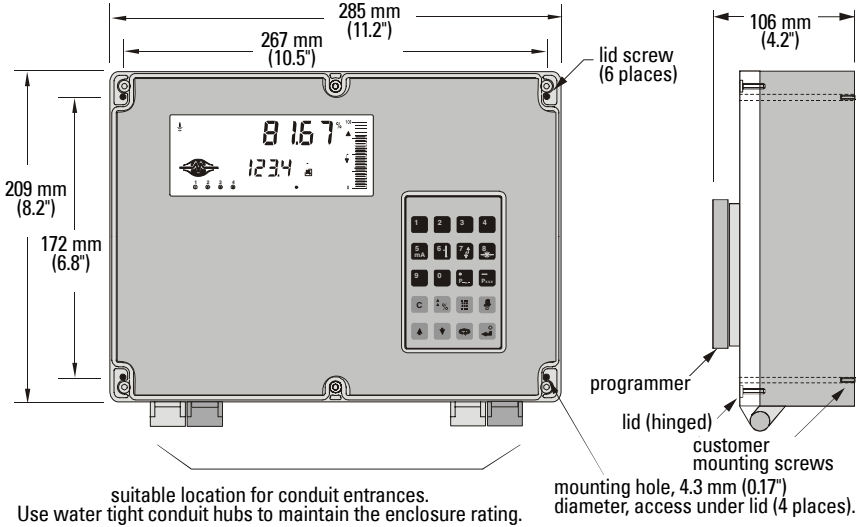

## Warnings

- **Non metallic enclosure does not provide grounding between connections. Use grounding type bushings and jumpers.**
- **This product is susceptible to electrostatic shock. Follow proper grounding procedures.**

## Transducer Mounting

Objects near the transducer face cannot be reliably detected. Mount the transducer above the highest material level (away from the nearest monitored object) by the following *Nearest Distance*.

Nearest Distance	Transducer Types
0.5 m (1.65 ft) <sup>1</sup>	ST-H, ST-25, XRS-5, XCT-8, XCT-12, XPS-10, XPS-15, ST-50
0.66 m (2.17 ft)	XPS-30, XPS-40
0.99 m (3.25 ft)	ST-100, LR-21, XLT-30, XLS-30
1.32m (4.33 ft)	LR-13, XLT-60, XLS-60

<sup>1</sup> This is the recommended minimum distance. However, it can be reduced under certain circumstances. Please check the appropriate transducer manual for details.



# Interconnection

Before interconnecting system components to the SITRANS LU01 terminals, verify all components have been installed in accordance with the associated product instruction manuals.

Connect all associated equipment cable shields to the SITRANS LU01 shield connections. To avoid differential ground potentials, do not connect cable shields to ground (earth) elsewhere. Insulate or tape cable shields at all shield junctions to prevent ground loops.

## AC Model

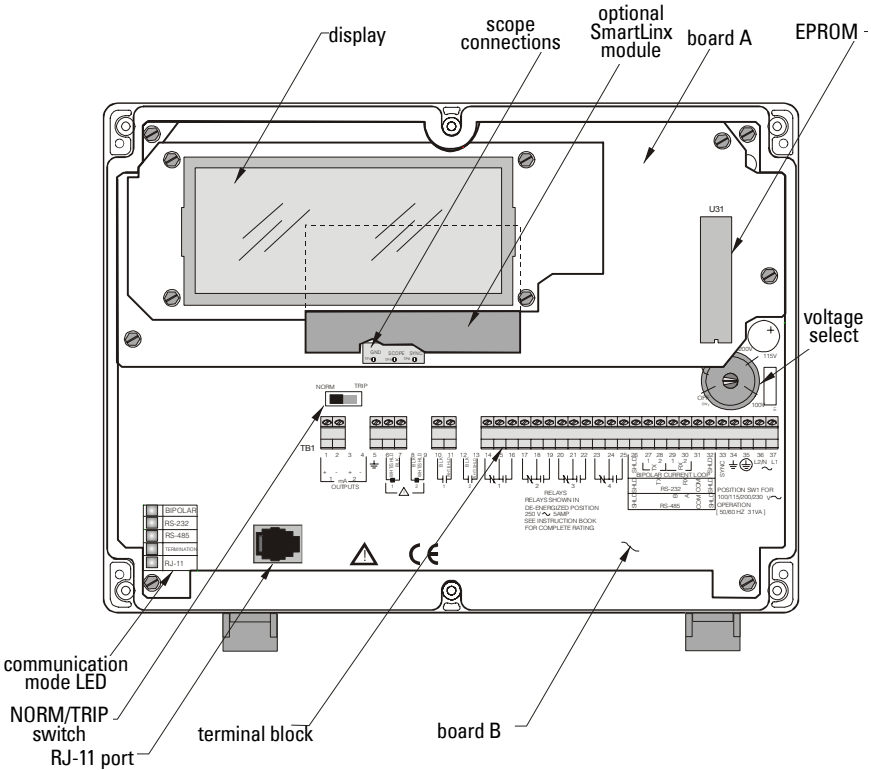

Installation

**WARNINGS:**

- All field wiring must have insulation suitable for at least 250V.
- Hazardous voltage present on transducer terminals during operation
- Relay contact terminals are for use with equipment having no accessible live parts and wiring having insulation suitable for at least 250V.

# DC Model

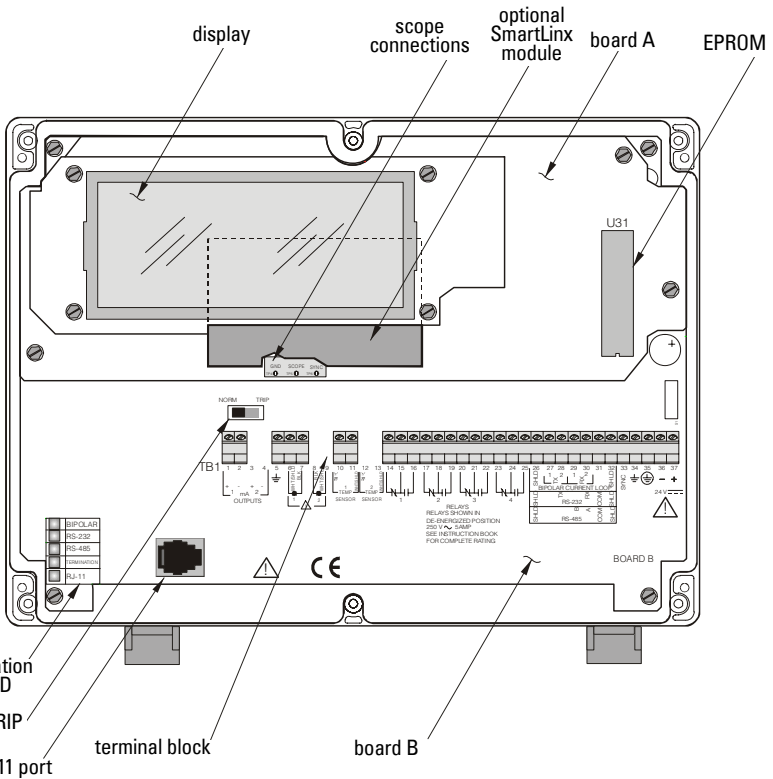

Installation



**WARNINGS:**

- All field wiring must have insulation suitable for at least 250V.
- Hazardous voltage present on transducer terminals during operation
- Relay contact terminals are for use with equipment having no accessible live parts and wiring having insulation suitable for at least 250V.

# Optional SmartLinX Module

The standard SITRANS LU01 unit may also be enhanced with Siemens Milltronics SmartLinX communication modules that provide an interface to popular industrial communication systems.

## To change or install SmartLinX module:

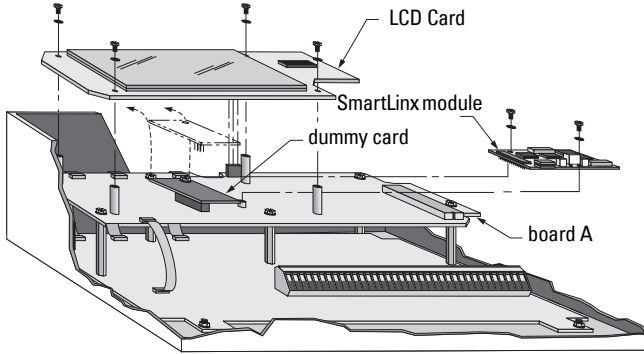

With power off and SITRANS LU01 lid opened:

1. Remove the 4 LCD card screws and the card itself.
2. Remove the one dummy card screw and the card itself.
3. Mount the card by mating the connectors and secure the card in place using the two screws provided.

**Note:** Refer to the SmartLinX module documentation for any required hardware settings prior to replacing the LCD card or closing the SITRANS LU01 lid.

4. Wire in the SmartLinX card according to SmartLinX Manual.
5. Replace the LCD card and secure in place using the screws removed in Step 1.

# System Diagram

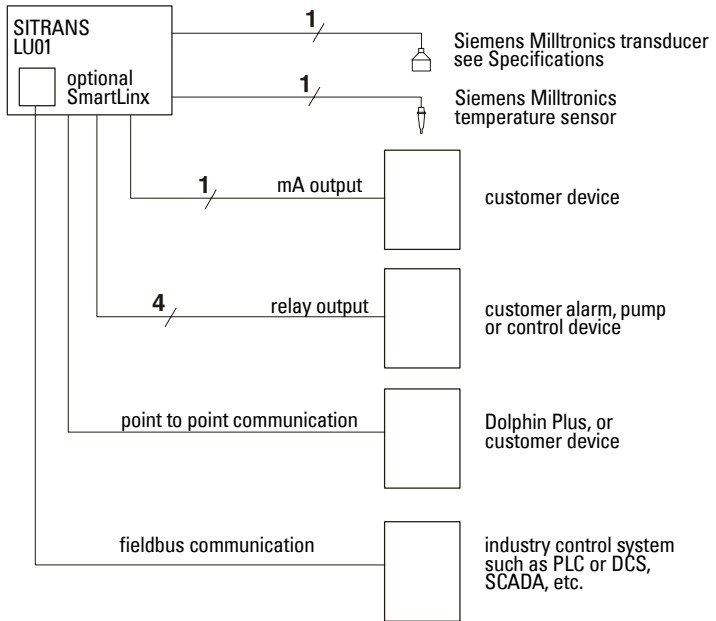

**Note:** Maximum system capability. Not all components or their maximum quantity may be required.

## Transducer

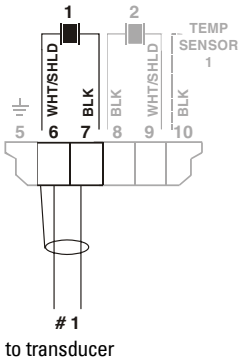

### Notes:

- Transducer cables must be run in a grounded metal conduit separate from other wiring (except TS-3 temperature sensor wiring, if applicable).
- Hazardous voltage present on transducer terminals during operation.

# Temperature Sensor

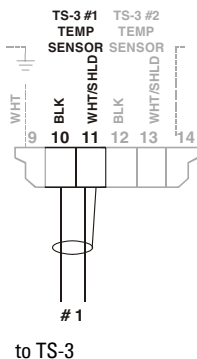

**Note:** Use TS-3 temperature sensor only. Do not jumper the terminals if TS-3 is not used.

# Relays

All relays are certified for use in equipment where the short circuit capacity of the circuits in which they are connected is limited by fuses having ratings not exceeding the rating of the relays.

**Note:** relays are shown in de-energized state.

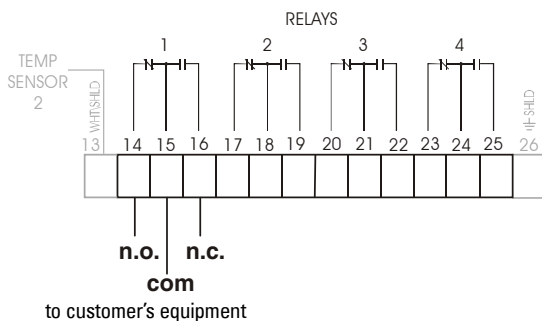

Installation

See Specifications for ratings.

# mA Outputs

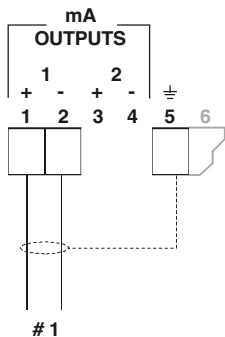

0/4-20mA isolated output to 750Ω max

# Communication

## Notes:

- The communication protocol is automatically detected by the SITRANS LU01 and shown via LED on the motherboard.
- Ground shield at one end only.

## Serial

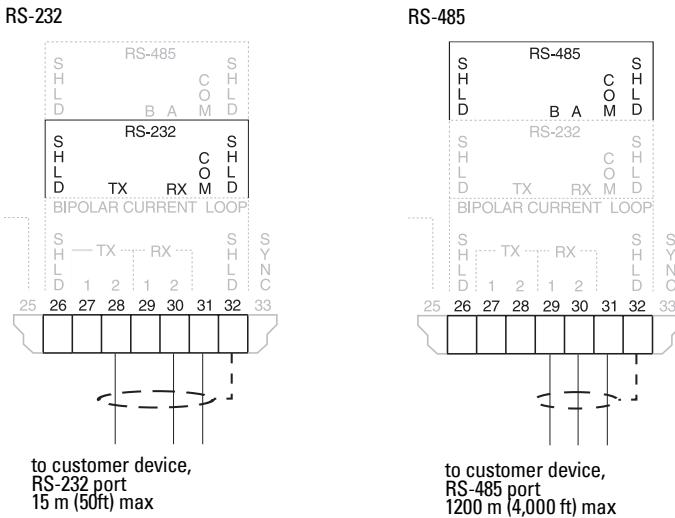

## SmartLinx

Refer to the appropriate SmartLinx manual for installation and wiring.

## Level System Synchronization

Avoid mounting the SITRANS LU01 near another ultrasonic level monitor. Likewise, when more than one monitor is installed within a single plant/facility, ensure the transducer cables of each system are run in separate grounded metal conduits. If this system separation is impractical, or if measurement difficulties are encountered, system synchronization may be required.

Synchronize the SITRANS LU01 with another SITRANS LU01

1. Mount the level monitors together in one cabinet.
2. Ensure the level monitors share a common power (mains) supply, and ground (earth).
3. Interconnect the SYNC terminals of the level monitors to be synchronized.

**Note:** To synchronize the SITRANS LU01 with other Siemens Milltronics ultrasonic level monitors, contact Siemens Milltronics or your local distributor.

# Power

**Note:** Before making the power connection, ensure proper voltage selection.

## AC Supply Wiring

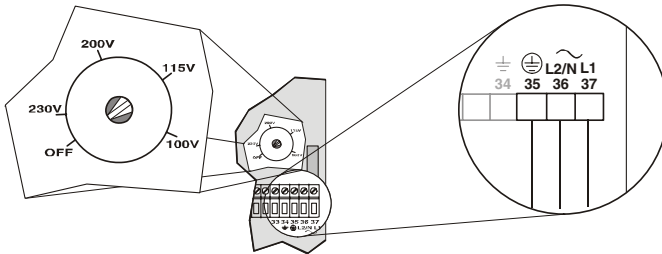

voltage switch shown in the 'OFF' position. Select appropriate voltage.

100/115/200/230 V  
50 / 60 Hz  
Select voltage via switch.

### Notes:

- The equipment must be protected by a 15 A fuse or circuit breaker in the building installation.
- A circuit breaker or switch in the building installation, marked as the disconnect switch, shall be in close proximity to the equipment and within easy reach of the operator.
- Never operate the SITRANS LU01 with the enclosure lid open, or with the ground (earth) wire disconnected.
- Ensure that any associated alarm or control equipment is disconnected until satisfactory operation is verified.

## DC Supply Wiring

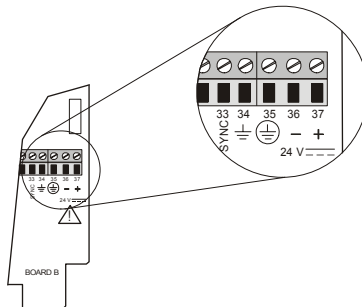

**Notes:** DC terminals shall be supplied from a SELV source in accordance with IEC-1010-1 Annex H.

# Programmer

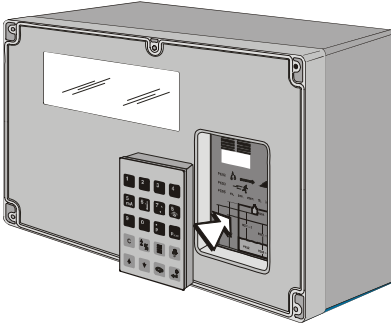

The hand programmer fits into the docking bay and is kept there with a magnet.

Use the hand programmer to change individual parameters

# Communications Access

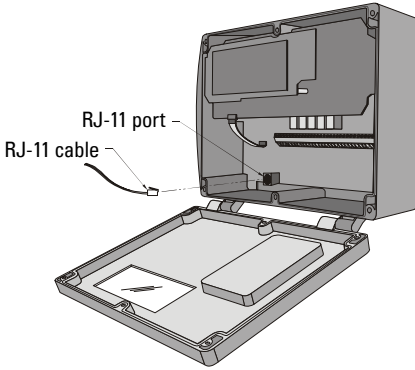

Communications link is through the internal RJ-11 port.



# Programming

Operator programmable features are identified by a Point Number and Parameter Number. The Index refers to the Relay Number as identified by the Index Type indicators. Parameter Numbers have a preset Parameter Value for each Index Number.

Program the SITRANS LU01 to obtain the desired RUN mode operation.

## Display

In PROGRAM mode, the Index Type, Index Number, Parameter Number, and Parameter Value (as well as a variety of other programming information) may be viewed.

Note that many indicators are specific to certain programming conditions and therefore, all indicators are not displayed at any given time.

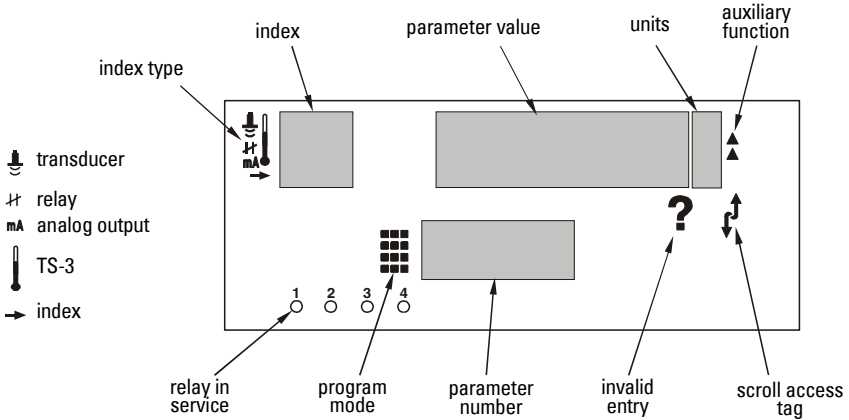

Display Segment	Description
Parameter Number	the programmable feature the Parameter Value refers to.
Index Type	see chart below
Index	the relay the Parameter Value refers to.
Parameter Value	the current value of the Parameter Number for the Index number displayed.
Percent	indicates the Parameter Value is displayed in percent.
Invalid Entry	indicates the value entered is questionable. The unit will not accept values out of range.
Auxiliary Function	indicates Auxiliary Function access (applies to only some Parameter Numbers).
Scroll Access Tag	indicates the Parameter Value may be scroll accessed.
Program Mode	indicates PROGRAM mode is accessed.

Icon	Index Type
	measurement point or transducer
	relay
	secondary index
	mA output

# Keypad

In PROGRAM mode, use the SITRANS LU01 programmer keys to perform the identified functions.

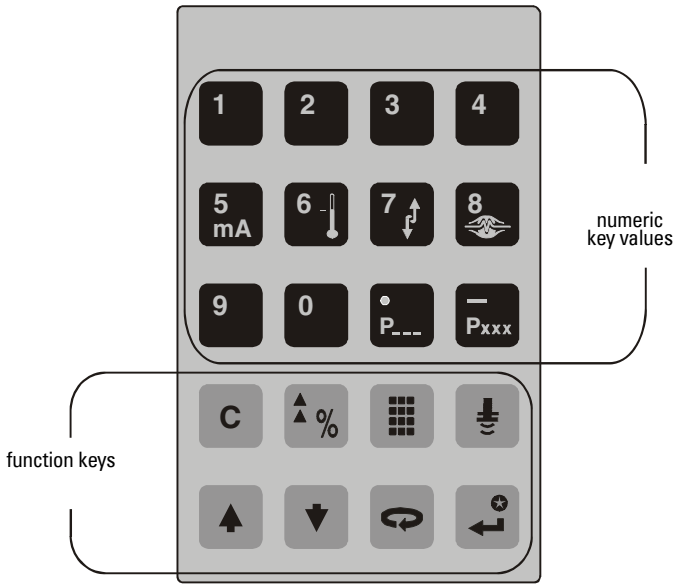



Key	Description
	DISPLAY: shift access to Index, Parameter Number, or Parameter Value display.
	NUMBERS: enter the numeric value into the accessed display.
	DECIMAL POINT: enter a decimal point (moves Profile and TVT Pointers left).
	NEGATIVE VALUE: enter a negative Parameter Value (moves Profile and TVT Pointers right).
	CLEAR: delete the current Parameter Value display (initiate a parameter reset).
	ENTER: store the current Parameter Value in memory (complete a parameter reset).
	MODE: switch the Parameter Value to % or Units (access Auxiliary Parameter Function).
	ARROW UP: increase the accessed display value.
	ARROW DOWN: decrease the accessed display value.
	TRANSDUCER: fire the transducer.
	PROGRAM: enter RUN mode.

# Program Mode Entry

Upon initial power application, the SITRANS LU01 displays **OFF**.





## To enter PROGRAM mode



1. Secure the enclosure lid using the 6 captivated screws.
2. Place the infrared programmer in the enclosure lid recess.
3. Press PROGRAM  and then press DISPLAY .



When PROGRAM mode is entered after RUN mode operation, all operating data is retained in memory. Relay status and mA output values are held at last known values (unless affected by a parameter alteration or ) until RUN mode is re-entered. RUN mode is automatically re-entered if the SITRANS LU01 is left unattended in PROGRAM mode for an extended period.

# Changing Parameters

Enter the new value, and press ENTER . The SITRANS LU01 interprets the value, either accepting or replacing it with a valid value.

1. Starting in RUN mode, press PROGRAM  and then press DISPLAY  to put the unit into PROGRAM mode.
2. Press DISPLAY  to select the Parameter Number field.
3. Key in the desired Parameter Number, or press SCROLL  or  as required .  
After the third digit is entered, the parameter value is shown.

(By default, the SCROLL arrows   show only the Quick Start Parameters and any that have been changed).

4. Press DISPLAY  as required to underline the Index display field.
5. Key in the desired Index or press SCROLL  or  as required.

To alter the Parameter Value for all Indices at once, select Index 00.



Enter the new value, and press ENTER . The SITRANS LU01 interprets the value, either accepting or replacing it with a valid value. .

### Notes:

- Record each Parameter Value alteration on the appropriate Programming Chart for future reference, (especially should complete reprogramming be required).
- If Parameter Value alteration is not permitted, access the Lock parameter (P000) and enter the security code (See Programming Security).

# Parameter Reset Features

On initial power up, all parameters are at default values. In many cases, when a Parameter Value is altered, associated Parameter Values are automatically altered accordingly. When a Parameter Number is accessed, if the preset Parameter Value displayed is acceptable, no entry is required.

To return an operator adjusted Parameter Value to the preset value, with the appropriate Index and Parameter Number displayed press CLEAR  and ENTER .

To reset all parameters to preset values, use Master Reset (P999).

**Note:** Perform a Master Reset (P999) if the SITRANS LU01 was bench tested using arbitrary Parameter Values before system installation, following an EPROM replacement, or whenever complete reprogramming is required.

## Parameters Types

### View Only Parameters

Parameter values indicating status only. They cannot be altered.

### Global Values

Parameter values common to all inputs and outputs on the SITRANS LU01.

When a global parameter is accessed, the index display automatically disappears. When a non-global parameter is accessed, the index display reappears showing the last index number.

### Parameter Indexing

To set all indexed values for a parameter to the same value, use index **0**.

## Programming Security

All operator programming is retained in non-volatile memory, immune to power interruptions. When programming is complete, the programmer may be removed and locked away to prevent inadvertent programming alteration. Use the Lock (P000) parameter to secure the SITRANS LU01.

# Operation

In RUN mode, the SITRANS LU01 detects material levels and provides control functions. The SITRANS LU01 automatically starts in RUN mode when power is applied.

## Display in RUN Mode

In the RUN mode, the following values and indicators are observed. Many indicators are specific to certain operating conditions and so not all indicators are not displayed at any given time.

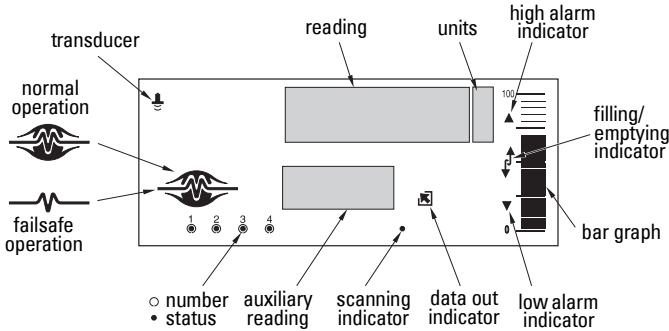

Display Segment	Description
Transducer	the current display linked to transducer measurement.
Reading	displays the level, space, or distance (flashes error messages, if any).
Percent	the Reading is in percent.
High Alarm	indicates level has risen above 80% (and not yet fallen below 75%).
Low Alarm	indicates level has fallen below 20% (and not yet risen above 25%).
Filling Indicator	indicates the vessel is filling.
Emptying Indicator	indicates the vessel is emptying.
Bar Graph	indicates the <i>absolute</i> (always a positive value) material level from 0 to 100%.
Data Out	indicates the SITRANS LU01 is transmitting data to the Peripheral Communications terminals.
Scanning Indicator	indicates point number scanned
Auxiliary Reading	as selected by the keypad (terminal numbers if transducer or TS-3 is wired wrong).
Relay Number	indicates the relays programmed for operation.
Relay Status	indicates the relay is de-energized (alarm is activated).
Normal Operation	indicates operating conditions are good and the Reading is reliable.
Failsafe Operation	indicates operating conditions are poor and the Reading may be incorrect.

# Keypad

In RUN mode, the following programmer keys perform the identified functions.

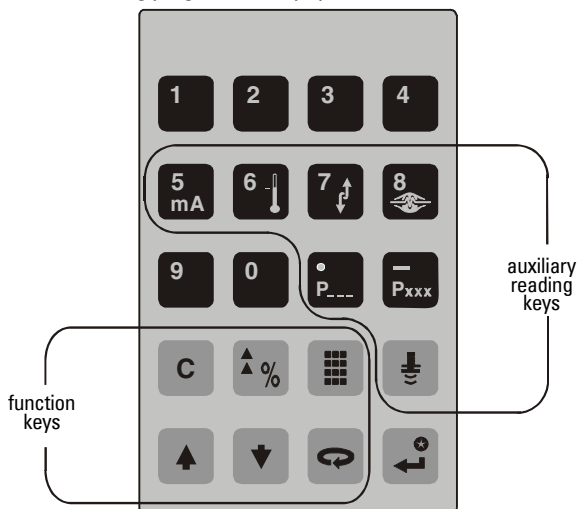

Key	Description
	selects the Auxiliary Reading "mA output value".
	selects the Auxiliary Reading "vessel atmosphere temperature".
	selects the Auxiliary Reading "rate of material level change".
	selects the Auxiliary Reading "failsafe time left" (in percent).
	selects the Auxiliary Reading "parameter value" (Key in any Parameter Number).
	selects the Auxiliary Reading "material level" (may be operator altered via P731).
	selects the Auxiliary Reading "distance" (material level to transducer face).
	initiates PROGRAM mode access (see  ).
	switches the Reading between "Units/percent of Span" (completes PROGRAM mode access).
	stops/starts the Point Number auto display scroll.

# System Performance Evaluation

For initial RUN mode entry (or after any programming alteration), do not use the SITRANS LU01 to operate process control equipment until satisfactory system programming and performance is verified.

- Press  to enter the RUN mode. ---- may be displayed briefly while the SITRANS LU01 takes measurements and calculates the Reading.  
If an alarm symbol is displayed, the corresponding relay is de-energized.

Point	Alarm Indicator	Relay
1	High Alarm	1
1	Low Alarm	2

- Press  to display Readings in % (percent of Span, P007) based upon Operation (P001).

Operation	Level	Space or Distance*
Empty to Full =	0 to 100%	100 to 0%

\* Objects close to the transducer face (0%) are not detectable.

- Press  to observe the mA output value for the Point Number displayed (Auxiliary Reading).

Operation	Level	Space or Distance*
Empty to Full =	4-20 mA	20-4 mA

\* Objects close to the transducer face (4 mA) are not detectable.

- Press  to observe the *Failsafe Time Left* (time left in percent before failsafe activation).

Each time a valid measurement is made, this value (Auxiliary Reading) is reset to 100 and begins to fall toward 0 until the next valid measurement is made.

If the Failsafe Time Left reaches 0, the SITRANS LU01 flashes LOE in the Reading display.

All associated data is supplied to the Peripheral Communications terminals (27 and 28).

## Performance Test Results

Monitor system performance carefully, under all anticipated operating conditions.

- If the SITRANS LU01 performs exactly as required, copy all Parameter Value alterations to the Programming Charts in the back of this instruction manual. (Altered Parameter Values may be scroll accessed). No further action is required. The SITRANS LU01 will continue performing reliably, with little or no maintenance.
- If a measurement difficulty is encountered (the LOE display persists after start up), or performance does not meet installation requirements, proceed to the Troubleshooting Guide on page 99.

- C. If the SITRANS LU01 provides accurate and repeatable measurements, however alternate Reading units, failsafe action, relay, or mA output operation is desired, proceed to Application Parameters on page 32.

If all operating conditions cannot be observed during the System Performance Evaluation, refer to Enhancement Parameters Reading Measurement (P920). Perform a Reading Measurement simulation to verify programming.

Ensure the Programming Charts are altered accordingly, and a new System Performance Evaluation is conducted, following any operation alteration or measurement difficulty remedy.

**Note:** Connect (or enable) process control / alarm equipment to the SITRANS LU01 only after satisfactory performance is verified for all possible operating conditions.



# Parameter Reference

The SITRANS LU01 is configured through its parameters, and the application determines the parameter values which are entered into the unit.



Please check your value entries carefully before operating the SITRANS LU01 to ensure optimum performance.

## Helpful Hints

Please note the following:

- **Default** values are always indicated with an asterix (\*)
- **Global** values are common for all inputs and outputs on the unit
- **Indexed** parameters can apply to more than one relay
- **Primary index** relates to a relay
- **Secondary index** allows for multiple values on an indexed point
- **View only** parameters are for display only and cannot be altered. These parameters are marked as view only in the Parameter values.

### In PROGRAM mode

1. Press  as required to underline the Parameter Number display field.
2. Key in the desired Parameter Number, (**direct access**) or press  or  as required (**scroll access**).

(As preset, Quick Start Parameters, and previously altered parameters may be scroll accessed ).



3. With the desired Parameter Number displayed, key in the desired Parameter Value and press .

#### Notes:

- Record each Parameter Value alteration on the appropriate Programming Chart for future reference, in case complete reprogramming is required.
- If Parameter Values cannot be altered, access the Lock parameter (P000) and enter the security code (See Programming Security).

## Parameter Reset Features

On initial power up, all parameters are at original values. In many cases, when a Parameter Value is altered, associated Parameter Values are automatically altered accordingly.

To return an operator adjusted Parameter Value to the preset value, with the appropriate Index and Parameter Number displayed, press , . To reset all parameters to preset values, refer to Master Reset (P999) on page 84.

### Note:

Perform a Master Reset (P999) if the SITRANS LU01 was *bench tested* using arbitrary Parameter Values before system installation, following an EPROM replacement, or whenever complete reprogramming is required.

## Programming Security

All operator programming is retained in non-volatile memory, immune to power interruptions. When programming is complete, the programmer may be removed and locked away to prevent inadvertent programming alteration. As well the Lock (P000) parameter may be used.

### P000 Lock

*Secures the SITRANS LU01 from changes*

Values	1954	*	OFF (programming permitted)
	-1		Simulation Controls (relays energize based on simulated level)
	other		lock activated (programming secured)

**WARNING: Use this lock as backup security only. It uses a fixed value which can be discovered by unauthorized personnel.**

Access this parameter directly (type **000**) and enter any value (except 1954) to secure programming lock. To remove the programming lock, access this parameter and enter **1954**. You cannot scroll to this parameter.

# Quick Start (P001 to P007)

## P001 Operation

*Sets the type of measurement required for the application.*

Values	0		Out-of-service
	1		Level – how full the vessel is (Point 1 and/or 2 only)
	2		Space – how empty the vessel is (Point 1 and/or 2 only)
	3	*	Distance – distance from transducer to material (Point 1 and/or 2 only)

## P002 Material

*Specifies material type. If the material presents a flat surface perpendicular to the transducer beam, select liquid.*

Values	1	*	Liquid or flat surface
	2		Solid or angled surface
Alters	• P830 TVT Type		

## P003 Maximum Process Speed

*Determines level change reaction speed.*

Values	1		Slow (0.1 m/min)
	2	*	Medium (1 m/min)
	3		Fast (10 m/min)
	4		Surge (1.7 m/sec)
	5		Immediate (17 m/sec)
Alters	<ul style="list-style-type: none"> <li>• P070 Failsafe Timer</li> <li>• P700 Max Fill Rate</li> <li>• P701 Max Empty Rate</li> <li>• P702 Filling Indicator</li> <li>• P703 Emptying Indicator</li> <li>• P704 Rate Filter</li> <li>• P710 Fuzz Filter</li> <li>• P713 Echo Lock Window</li> <li>• P727 Scan Delay</li> <li>• P841 Long Shot Number</li> </ul>		
Related	<ul style="list-style-type: none"> <li>• Failsafe (P070 to P072)</li> <li>• Rate (P700 to P708)</li> <li>• Measurement Verification (P710 to P713)</li> <li>• Transducer Scanning (P726 to P729)</li> <li>• P905 Transmit Pulse</li> </ul>		

Use a setting just fast enough to keep up with your process. Slower settings provide higher accuracy. Faster settings allow for more level fluctuations.

## P004 Transducer

*Specifies the Siemens Miltronics transducer connected to the unit.*

<b>Values</b>	0	*	No transducer attached
	1		ST-25
	2		ST-50
	3		ST-100
	4		LR-21
	5		LR-13
	100		ST-H
	101		XCT-8
	102		XPS-10
	103		XCT-12
	104		XPS-15
	105		XPS-30
	106		XPS-40
	107		XLT-30
108		XLT-60	
109		XLS-30	
110		XLS-60	
112		XRS-5	
<b>Related</b>	<ul style="list-style-type: none"> <li>• P842 Short Shot Frequency</li> <li>• P843 Long Shot Frequency</li> <li>• P844 Short Shot Width</li> <li>• P845 Long Shot Width</li> <li>• P852 Short Shot Range</li> </ul>		

## P005 Units

*Specifies measurement units used for dimensional values.*

<b>Values</b>	1	*	Meters (m)
	2		Centimeters (cm)
	3		Millimeters (mm)
	4		Feet (ft)
	5		Inches (in)
<b>Alters</b>	<ul style="list-style-type: none"> <li>• P006 Empty</li> <li>• P007 Span</li> <li>• P060 Decimal Position</li> <li>• P921 Material Measurement</li> <li>• P927 Distance Measurement</li> </ul>		

Changing this value automatically changes the units displayed for many parameters. Existing values are converted and do not have to be re-entered.

## P006 Empty

Enter distance in **units** (P005) from the face of the transducer to the process empty point.

<b>Values</b>	Range: 0.000 to 9999
	Preset: 5.000 m (or equivalent depending on units)
<b>Alters</b>	<ul style="list-style-type: none"> <li>• P007 Span</li> </ul>
<b>Altered By</b>	<ul style="list-style-type: none"> <li>• P005 Units</li> </ul>
<b>Related</b>	<ul style="list-style-type: none"> <li>• P800 Near Blanking</li> <li>• P921 Material Measurement</li> <li>• P927 Distance Measurement</li> </ul>

Setting this value also sets Span (P007) unless Span was already set to another value. For distance operation (P001=3), Span is preset to Empty.

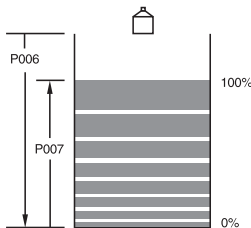

## P007 Span

Sets the range level to be measured.

<b>Values</b>	Range: 0.000 to 9999
	Preset: based on Empty (P006)
<b>Alters</b>	<ul style="list-style-type: none"> <li>• P112 Relay ON Setpoint</li> <li>• P113 Relay OFF Setpoint</li> </ul>
<b>Altered By</b>	<ul style="list-style-type: none"> <li>• P005 Units</li> <li>• P006 Empty</li> </ul>
<b>Related</b>	<ul style="list-style-type: none"> <li>• Volume (P050 to P055)</li> <li>• P800 Near Blanking</li> <li>• P921 Material Measurement</li> <li>• P922 Space Measurement</li> </ul>

Span is automatically preset to 1.1 x the blanking value (P800) less than the Empty value (P006), unless it is altered manually.

For distance operation (P001 = 3), Span is preset to the Empty value (P006).

Enter a lower value if desired. If the automatic setting is not high enough, mount the transducer higher (see Installation/Transducer Mounting on page 10) and enter the new Empty (P006) distance.

# Application Parameters



## Volume (P050 to P055)



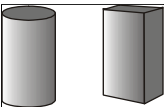
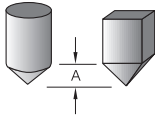
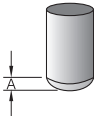
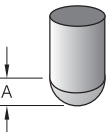
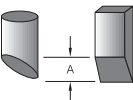

Use these parameters to enable the SITRANS LU01 to show readings based on vessel volume (rather than level).

### P050 Tank Shape

Enter the Tank Shape value matching the monitored vessel or wet well.

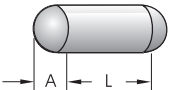
When Operation is **level** (P001 = 1), liquid (material) volume is calculated. Alternatively, when Operation is **space** (P001 = 2), remaining vessel capacity is calculated. In RUN mode, readings are displayed in percent of maximum volume. To convert readings to volumetric units, see *Maximum Volume (P051)*.

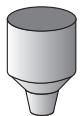
Values	#	Shape	Description
	0	*	volume calculation not required (preset)
	1		Flat Level Bottom
	2		Cone/Pyramid Bottom
	3		Parabola Bottom
	4		Half Sphere Bottom
	5		Flat Sloped Bottom
6		Flat Ends	

Values	7		Parabola Ends
	8		Sphere
	9		Universal Linear
	10		Universal Curved
Alters	<ul style="list-style-type: none"> <li>• P001 Operation</li> <li>• P051 Maximum Volume</li> <li>• P920 Reading Measurement</li> </ul>		

## P051 Maximum Volume

*For Readings in volumetric units (rather than percent), enter the vessel volume between Empty (P006) and Span (P007).*

Values	Range: 0.000 to 9999
	Preset: 100.0
Alters	P060 Decimal Position
Related	<ul style="list-style-type: none"> <li>• P006 Empty</li> <li>• P007 Span</li> <li>• P924 Volume Measurement</li> </ul>

Any volume units can be chosen because volume is calculated from empty to maximum span and is scaled according to the Tank Shape (P050) value.

**Note:** Make sure selected chosen units allow LCD volume display.

**Examples:**

If max. volume = 3650 m<sup>3</sup>, enter 3650

If max. volume = 267500 gallons, enter 267.5 (thousands of gallons)

## P052 Tank Dimension A

*Dimension A as used in P050 Tank Shape.*

<b>Values</b>	Range: 0.0 to 9999
	Preset: 0.000
<b>Related</b>	• P050 Tank Shape

Enter one of the following:

- height of the tank bottom if P050 = 2, 3, 4, or 5
- or
- length of one end section of the tank if P050 = 7, in Units (P005)

## P053 Tank Dimension L

*Dimension L as used in P050 Tank Shape.*



<b>Values</b>	Range: 0.0 to 9999
	Preset: 0.000
<b>Related</b>	• P050 Tank Shape

Enter the following:

- tank length (excluding both end sections) if P050 = 7

## Universal Volume Calculation

**P054 and P055 use secondary indices. To access a secondary index:**

1. Press DISPLAY  to activate primary index. The  icon appears under the index field.
2. Enter the values to set the breakpoints.

## P054 Level Breakpoints (Universal Volume Calculation)

*When the tank shape is too complex for any of the preconfigured shapes, you can specify the volume based on segments.*



<b>Primary Index</b>	Breakpoint
<b>Values</b>	Range: 0.0 to 9999
<b>Related</b>	• P055 Volume Breakpoints

Enter the following:

- up to 32 level breakpoints (where volume is known) if P050 = 9 or 10



## Entering a Level Breakpoint

1. Go to Parameter P054.
2. Press  to display the index symbol.
3. For each index enter a volume.
4. Ensure that each volume corresponds to the same index for P055.
5. Press .

For more on Volume Characterization, go to page 87.

## P055 Volume Breakpoints and Characterization (Universal Volume Calculation)

*Each segment defined by the level breakpoints (P055) requires a volume so that the SITRANS LU01 can make the level-to-volume calculations.*

<b>Primary Index</b>	Breakpoint
<b>Values</b>	Range: 0.0 to 9999
<b>Related</b>	• P054 Breakpoints Levels (Universal Volume Calculation)

### Typical volume calculations

Cone

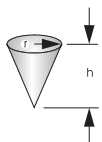

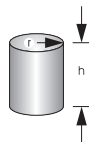

$$V = (1/3)\pi r^2 h$$

Cylinder



$$V = \pi r^2 h$$

### Entering a Volume Breakpoint

1. Go to Parameter P055.
2. Press  to display the index symbol.
3. For each index enter a volume.
4. Ensure that each volume corresponds to the same index for P054.
5. Press .

For more on Volume Characterization, go to page 87.

## Display and Reading (P060 to P062)

These parameters are used to:

- Change the number of decimal places displayed
- Convert the Reading to alternate units
- Reference measurements to other than Empty (P006) or Span (P007)

### P060 Decimal Position

*Defines the maximum number of decimal places used on the LCD.*

<b>Values</b>	0	No digits after the decimal point
	1	1 digit after the decimal point
	2	* 2 digits after the decimal point
	3	3 digits after the decimal point (limited by device resolution)
<b>Altered by</b>	<ul style="list-style-type: none"> <li>• P005 Units</li> <li>• P051 Maximum volume</li> </ul>	
<b>Related</b>	<ul style="list-style-type: none"> <li>• P920 Reading Measurement</li> </ul>	

In RUN mode, the decimal position adjusts to prevent the number of digits from exceeding the display capabilities. To keep the decimal place from shifting, reduce the number of decimal places to that shown at 100%.

#### Example:

If 100% is 15 m, use two decimal places for sample readings of 15.00 or 12.15.

### P061 Convert Reading

*Multiplies the current value by the specified amount to allow for scaling.*

<b>Values</b>	Range: -999 to 9999
	Preset: 1.000
<b>Related</b>	<ul style="list-style-type: none"> <li>• P920 Reading Measurement</li> </ul>

#### Examples:

- If the measured value is in feet, enter **0.3333** to display the number of yards
- For simple linear, volume conversions set P005 to **1** (meters) and then enter the volume measurement per unit to get the correct conversion. For example, if the reservoir contains 100 litres per vertical meter, use **100** to get the reading in litres.

#### Notes:

- This method does not calculate volume. It must not be used in place of the volume parameters if any volume dependent features (such as pump efficiency) are used. To calculate true volumes see Volume (P050 to P055).
- Avoid entering a value that, when multiplied by the maximum current Reading, exceeds the display capabilities. If value exceeds four digits, EEEE is shown.

## P062 Offset Reading

Adds the specified value to the level reading, usually to reference the reading to sea level or another datum level.

<b>Values</b>	Range: -999 to 9999
	Preset: 0.000
<b>Related</b>	<ul style="list-style-type: none"> <li>• P920 Reading Measurement</li> </ul>

The operation of the device is not affected by the Offset Reading. This value is used for display purposes only. All control measurements are still referenced to Empty.

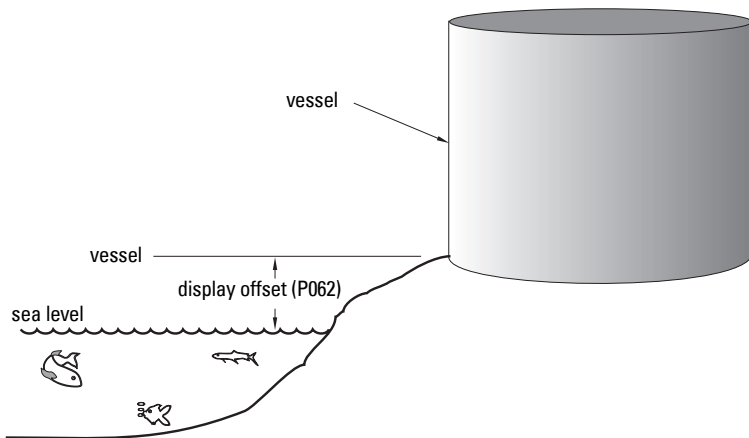

## Failsafe (P070 to P072)

As preset, in the event of a measurement or technical difficulty, the SITRANS LU01 holds the Reading, Bar Graph, mA outputs, and relays at their last known values.

To operate process control equipment under these conditions, alter the following parameters as required.

### P070 Failsafe Timer

*The time for invalid measurements to elapse before Failsafe State activates.*

<b>Values</b>	Range: 0.0 to 9999
	Preset 10.00 minutes
<b>Altered by</b>	<ul style="list-style-type: none"> <li>• P003 Maximum Process Speed</li> </ul>
<b>Related</b>	<ul style="list-style-type: none"> <li>• P129 Relay Failsafe</li> </ul>

In the RUN mode, when a difficulty first occurs, the Reading, Bar Graph, relay status, and mA outputs are held at last known values and the Failsafe Timer is activated.

When a valid measurement is made before the timer expires, the SITRANS LU01 advances to the new material level (if changed) as normal (per Measurement Response, P003) and the timer resets.

If the timer expires (before a valid measurement is made), the SITRANS LU01 advances to the Failsafe Material Level (P071) as restricted by Failsafe Advance (P072).

When a valid measurement is made after the timer expires, the SITRANS LU01 advances to the new material level (if changed), as restricted by Failsafe Advance (P072) and the timer resets.

If the timer expires due to a measurement difficulty, LOE flashes in the Reading display.

### Once activated, the Failsafe State initiates the following:

- The material level is reported based on P071 Failsafe Material Level.
  - The unit responds to the new level as programmed (control and alarm relays activate as defined by the programming).
  - Individual relays can have independent failsafe responses. See *P129 Relay Failsafe*.
- The appropriate error is displayed:
  - LOE** for loss of echo from the transducer
  - Short** for a shorted transducer cable
  - Open** for a cut transducer cable or a defective transducer
  - Error** for all other problems including reversed Ultrasonic/Temperature transducer terminal connections or wrong Transducer (P004) entered.

When modifying the preset value, set it short enough to protect the process but long enough to avoid false alarms. Only use **No Delay (0.0 Minutes)** for testing.





## P071 Failsafe Material Level

*The material level reported when a Failsafe State is initiated.*

<b>Values</b>	Range: -999 to 9999		Value in units or % (-50% to 150% of span)
	HI		Level goes to maximum span
	LO		Level goes to 0 span (Empty)
	HOLd	*	Level remains at last reading
<b>Related</b>	<ul style="list-style-type: none"> <li>P001 Operation</li> <li>P006 Empty</li> <li>P007 Span</li> <li>P111 Relay Control Function</li> <li>P112 Relay ON Setpoint</li> <li>P113 relay OFF Setpoint</li> <li>P129 Relay Failsafe</li> </ul>		

Select the Failsafe Material Level based upon the relay operation required during failsafe operation.

### Selecting HI, LO, or HOLd

- Press FUNCTION  to display the Auxiliary Function symbol.
- Press ARROWS   to scroll to the desired option.
- Press ENTER  to set the value.

## Relay reaction

The way in which relay programming reacts to the failsafe level depends on P129 Relay Failsafe (page 46). By default:

- Alarm relays have P129 = OFF and so react to the Failsafe Material Level.
- Control relays have P129 = **dE** and so de-energize the relay when the unit enters Failsafe mode regardless of the Failsafe Material Level.

## P072 Failsafe Level Advance

*Sets the speed the SITRANS LU01 advances to and returns from the Failsafe Material Level.*

<b>Values</b>	1	*	Restricted	Advances to/from Failsafe Material Level as set by P003, P700 and P701.
	2		Immediate	Failsafe Material Level assumed immediately
	3		Fast Back	Failsafe Level Advance is restricted, return is immediate
<b>Related</b>	<ul style="list-style-type: none"> <li>• P003 Maximum Process Speed</li> <li>• P070 Failsafe Timer</li> <li>• P071 Failsafe Material Level</li> <li>• P700 Max Fill Rate</li> <li>• P701 Max Empty Rate</li> </ul>			

## Relays (P100 to P119)

The SITRANS LU01 has four relays (or digital outputs) used to control devices and alarms. While the number of devices is limited by the relays, all control functions are accessible through software and each parameter is indexed to the relays.

The SITRANS LU01 makes **standard application** programming easier by providing an extensive list of presets in P100 (Preset Applications).

**Standard alarms** are set from P101 to P104. In the RUN mode, when the material level:

- rises to a High or High High Alarm value, the associated Alarm and Relay Status indicators are displayed and the allocated relay(s) de-energize.
- falls 5% of Span (P007) below the High or High High Alarm value, the associated Alarm and Relay Status indicators extinguish, and the allocated relay(s) energize.
- falls below the Low or Low Low Alarm value, the associated Alarm and Relay Status indicators are displayed and the allocated relay(s) de-energize.
- rises 5% of Span (P007) above the Low and Low Low Alarm value, the associated Alarm and Relay Status indicators extinguish, and the allocated relay(s) energize.

**Note:** Enter all standard alarm material level values in Units (P005) or percent of Span (P007) as referenced to Empty (P006).

To display the current value (or enter a new value) in percent of Span, press  % as required to display the % symbol.

**Control functions** allow each relay to be configured independently to take advantage of the SITRANS LU01's advanced features and flexibility. Start with a preset application and then change the required parameters to make the task more efficient.

**Setpoints** are set up in P112 and P113. Each relay is triggered by one or more setpoints. The setpoints can be based on absolute level (P112, P113) or rate of change (P702, P703). Each control function specifies which setpoints are required.

## P100 Preset Applications

*This parameter presets relays to operate as Standard Alarms. The Relay Allocation (relay/point number association) and Standard Alarm (P101 to P104) parameters are also preset.*

*Relay status during a measurement difficulty is dependent upon Failsafe programming. See Failsafe Parameters (P070 to P072) and Relay Failsafe (P129). As preset, relay status is held at last known material levels until a valid measurement is made.*

Option	Relay #	Point #	Standard Alarm (as % of Span, P007)
1	1	1	(High Alarm) P101 = 80.00%
	2	1	(Low Alarm) P102 = 20.00%
	3	2	(High Alarm) P101 = 80.00%
	4	2	(Low Alarm) P102 = 20.00%
2	1	1	(High Alarm) P101 = 80.00%
	2	1	(High High Alarm) P103 = 90.00%
	3	2	(High Alarm) P101 = 80.00%
	4	2	(High High Alarm) P103 = 90.00%
3	1	1	(Low Alarm) P102 = 20.00%
	2	1	(Low Low Alarm) P104 = 10.00%
	3	2	(Low Alarm) P102 = 20.00%
	4	2	(Low Low Alarm) P104 = 10.00%
4	1	1	(High Alarm) P101 = 80.00%
	2	1	(Low Alarm) P102 = 20.00%
	3	1	(High High Alarm) P103 = 90.00%
	4	1	(Low Low Alarm) P104 = 10.00%

Independently altered Standard Alarms (P101 to P104), Relay Allocation (P110), Relay Function (P111) and Relay ON/OFF Setpoints (P112/P113) are automatically reset when a Relay Set Up value is altered.

<b>Values</b>	0	*	OFF
	1		Set Up 1
	2		Set Up 2
	3		Set Up 3
	4		Set Up 4
<b>Alters</b>	• P110 Level Source		
<b>Related</b>	• P001 Operation		

**Note:** Programming the relays independently is the most common method used.

## P101 High Alarm

*Enter the High Alarm material level for the index displayed. .*

<b>Primary Index</b>	Relay
<b>Values</b>	Range: -999 to 9999
	Preset 80.00% of Span or equivalent units

## P102 Low Alarm

*Enter the Low Alarm material level for the index displayed. .*

<b>Primary Index</b>	Relay
<b>Values</b>	Range: -999 to 9999
	Preset 20.00% of Span or equivalent units

## P103 High High Alarm

*Enter the High High Alarm material level for the index displayed, (Relay Set Up 2 or 4 only).*

<b>Primary Index</b>	Relay
<b>Values</b>	Range: -999 to 9999
	Preset 90.00% of Span or equivalent units

## P104 Low Low Alarm

*Enter the Low Low Alarm material level for the index displayed, (Relay Set Up 3 or 4 only)..*

<b>Primary Index</b>	Relay
<b>Values</b>	Range: -999 to 9999
	Preset 10.00% of Span or equivalent units

### Notes:

- **OFF** is displayed if the Relay Set Up (P100) selected does not use the Alarm parameter accessed.
- **Ch** is displayed if a Custom Relay Parameter was previously operator altered.

# Custom Relays (P111 to P113)

## P111 Relay Control Function

*Sets the control algorithm used to trip the relay.*

When accessed, the Parameter Type display changes to the Relay symbol and the Index display changes to the Relay Number (corresponding to the SITRANS LU01 terminals).

<b>Primary Index</b>	Relay
<b>Values</b>	See chart on next page
<b>Altered by</b>	<ul style="list-style-type: none"> <li>P100 Preset Applications</li> </ul>





Use zero **0** (preset) to disable control of the indexed relay.

**Note:** All relay ON/OFF points must be referenced from Empty (P006), regardless of Operation Mode selection (P001).

Function	Designation	Operation
Level	LL, L, H, or HH	Similar to Standard Alarms but with Relay ON/OFF Setpoints
In Bounds	b1 or b2 <sup>1</sup>	Alarms when level is between the Relay ON/OFF Setpoints
Out of Bounds	b1 or b2 <sup>1</sup>	Alarms when level is not between the Relay ON/OFF Setpoints
Rate	r1 or r2 <sup>1</sup>	Level rate of change alarm with Relay ON/OFF Setpoints
Temperature	Not applicable	Alarm is activated by independent Relay ON/OFF Setpoints
LOE	Not applicable	Relay de-energizes in the event of Failsafe timer (P700) expiry
Cable fault	Not applicable	Relay de-energizes under transducer short or opened condition
Pump	Not applicable	With independent Relay ON/OFF Setpoints

- The relay designation is not displayed but is included in the data message.

To enter a relay designation:

- Press  to display the Auxiliary Function symbol,
- Press  or  to scroll access the desired relay designation and...
- Press .

**Note:** When the Relay Function is altered, affected Alarm Parameters (P101 to P104) display "ch" (changed) when accessed. Use the Relay ON/OFF Setpoints (P112/P113) instead.

Refer to Point Alarm and Status section in SmartLinx instruction manuals for more information.



To reset the Relay Function to use Standard Alarms, enter the desired Relay Set Up (P100).

Values For P111			
Control	Type	# <sup>1</sup>	Relay Control
General	Off	0	Relay set off, no action (preset)
	Level	1*	Based on level setpoints ON and OFF
	In Bounds	2	When level enters the range between ON and OFF setpoints
	Out of Bounds	3	When level exits the range between ON and OFF setpoints
	Rate of Change	4	Based on rate setpoints ON and OFF
	Temperature	5	Based on temperature setpoints ON and OFF
	Loss of Echo (LOE)	6	When echo is lost
	Cable Fault	7	When the circuit to a transducer is opened
Pump	Fixed Duty Assist	50	At fixed ON and OFF setpoints and allows multiple pumps to run or for rake control

1. When reading and setting this parameter through Modbus or SmartLinx communications the parameter values are mapped to different numbers. See the relevant SmartLinx manual for Modbus information.

## Independent Relay Setpoints

Relay ON and OFF Setpoint values set the critical points (based on the Relay Function) where, in RUN mode:

- Relay status indicators are switched ON and OFF
- Alarm Indicators (if programmed) are switched ON or OFF
- Relays are *energized* and *de-energized*

For most Relay Functions, setpoint values represent material levels, entered in Units (P005) or percent of Span (P007) as referenced to Empty (P006). Temperature alarm values are entered in degrees Celsius (°C).

Rate alarms are entered in Units / minute or percent of Span per minute. A positive value is entered for a filling rate alarm; negative for emptying.

	Setpoints		Action			When
	ON	OFF	Status	Alarm	Relay	
Level H or HH	85%	70%	On	On	de-energizes	Level rises to 85%
			Off	Off	energizes	Level falls to 70%
Level L or LL	15%	30%	On	On	de-energizes	Level falls to 15%
			Off	Off	energizes	Level rises to 30%
In bounds ▲	80%	50%	On	On	de-energizes	Level falls to 78%
			Off	Off	energizes	Level rises to 82%
			On	On	de-energizes	Level rises to 52%
			Off	Off	energizes	Level falls to 48%
Out of bounds ▲	80%	50%	Off	Off	energizes	Level falls to 78%
			On	On	de-energizes	Level rises to 82%
			Off	Off	energizes	Level rises to 52%
			On	On	de-energizes	Level falls to 48%
Rate of change	+10%	+5%	Off	Off	de-energizes	Fill rate increases to 10%/min
			On	On	energizes	Fill rate decreases to 5%/min
	-10%	-5%	Off	Off	de-energizes	Empty rate increases to 10%/min
			On	On	energizes	Empty rate decreases to 5%/min
Temperature	60	55	On	On	de-energizes	Temperature rises to 60°C
			Off	Off	energizes	Temperature falls to 55°C
	-30	-25	On	On	de-energizes	Temperature falls to -30°C
			Off	Off	energizes	Temperature rises to -25°C
Pump	80%	20%	On	On	energizes	Start pump down on level at 80%
			Off	Off	de-energizes	Stop pump down on level at 20%
	20%	80%	On	On	energizes	Start pump up on level at 20%
			Off	Off	de-energizes	Stop pump up on level at 80%

\* Values shown are for illustration purposes only. Enter values which apply to your particular installation.

▲ 2% factory set deadband, adjustable via P116

## P112 Relay ON Setpoint

*Sets the process point at which the relay changes from its NORMAL state.*

<b>Primary Index</b>	Relay
<b>Values</b>	Range: -999 to 9999
	Preset: ----
<b>Altered by</b>	<ul style="list-style-type: none"> <li>• P007 Span</li> </ul>
<b>Related</b>	<ul style="list-style-type: none"> <li>• P100 Preset Applications</li> <li>• P111 Relay Control Function</li> <li>• P113 Relay OFF Setpoint</li> </ul>

For most applications, the relay is tripped at this point. For IN-BOUNDS and OUT-OF-BOUNDS alarms, it is the high point in the specified range. This parameter is set according to Span (P007) even when another reading, such as volume, is shown on the LCD.

**Note:** Relay ON and Relay OFF setpoint values cannot be exactly equal.

## P113 Relay OFF Setpoint

*Sets the process point at which the relay returns to its NORMAL state.*

<b>Primary Index</b>	Relay
<b>Values</b>	Range: -999 to 9999
	Preset: ----
<b>Altered by</b>	<ul style="list-style-type: none"> <li>• P007 Span</li> </ul>
<b>Related</b>	<ul style="list-style-type: none"> <li>• P100 Preset Applications</li> <li>• P111 Relay Control Function</li> <li>• P112 Relay ON Setpoint</li> </ul>

For most applications, the relay is reset at this point. For IN-BOUNDS and OUT-OF-BOUNDS alarms, it is the low point in the specified range. This parameter is set according to Span (P007), even when another reading, such as volume, is shown on the LCD.

## P116 Dead Band

*The distance above and below the bound alarm setpoints.*

<b>Primary Index</b>	Relay
<b>Values</b>	Range: 0.000 to 9999
	Preset: 2% of span
<b>Related</b>	<ul style="list-style-type: none"> <li>• P111 Relay Control Function</li> <li>• P112 Relay ON Setpoint</li> <li>• P113 Relay OFF Setpoint</li> </ul>

For IN-BOUNDS and OUT-OF-BOUNDS Relay Functions (P111 = 2 and 3 respectively), a dead band prevents relay chatter due to material level fluctuations at both the upper and lower setpoints.

Enter the dead band in either percent of span or units of measure (P005). The deadband value is applied both above and below the upper and lower bound setpoints as shown in the figure.

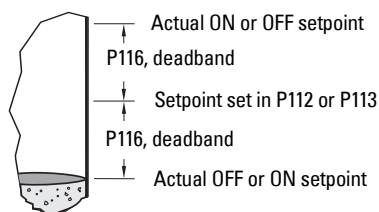

## Independent Relay Failsafe (P129)

### P129 Relay Failsafe

*Sets the failsafe operation per relay to allow for more flexible programming.*

Primary Index	Relay		
Values	OFF	*	Response governed by P071 Failsafe Material Level
	HOLD		For LAST KNOWN relay state retention
	dE		To have the relay de-energize immediately on failsafe
	En		To have the relay energize immediately on failsafe
Altered by	<ul style="list-style-type: none"> <li>P071 Failsafe Material Level</li> </ul>		
Related	<ul style="list-style-type: none"> <li>P070 Failsafe Timer</li> <li>P111 Relay Control Function</li> </ul>		

Use this for operations independent of the Failsafe Material Level (P070).

Relay Failsafe is only available for the following relay functions (P111) and is not used for any other relay control function.

Relay Function (P111)	Preset (P129)
1 – level alarm	OFF
2 – in bounds alarm	
3 – out of bounds alarm	
4 – rate of change alarm	
5 – temperature alarm	
50 – all pump controls	dE

#### To select an independent Relay Failsafe value:

- Press FUNCTION  $\left(\frac{\Delta}{\%}\right)$  to display the Auxiliary Function symbol.
- Press ARROWS  $\left(\uparrow\right)$   $\left(\downarrow\right)$  to scroll through the failsafe options.
- Select option and press ENTER  $\left(\rightarrow\right)$ .

## mA Output (P200 to P219)

When an mA Output Parameter is accessed, the mA symbol is displayed in the Index Type field and the mA output number (corresponding to the SITRANS LU01 terminals) is displayed in the Index field.

### P200 mA Output Range

*Determines the mA output range.*

Primary Index	mA output		
Values	0		off
	1		0 to 20 mA
	2	*	4 to 20 mA
	3		20 to 0 mA
	4		20 to 4 mA
Related	<ul style="list-style-type: none"> <li>P911 mA Output Value</li> </ul>		

If either **1** or **2** is selected, the mA output is directly proportional to the mA Function. If either **3** or **4** is selected, then the output is inversely proportional.

### P201 mA Output Function

*Alters the mA output/measurement relationship.*

Primary Index	mA output		
Values	value	mA function	Operation (P001)
	0	OFF	
	1	level	level
	2	space	space
	3	distance	distance
	4	volume	
Related	<ul style="list-style-type: none"> <li>P202 mA Output Allocation</li> <li>P911 mA Output Value</li> </ul>		
Altered By	<ul style="list-style-type: none"> <li>P001 Operation</li> </ul>		

### P203 mA Output Value / Transducer

*Displays current mA output value.*

Values	Range: 0.000 to 22.00 (view only)
--------	-----------------------------------

This displays as an Auxiliary Reading when  key is pressed in the RUN mode and does not include adjustments made using Trim features (P214 / P215).

**Note:** This parameter is applicable only if any mA output has the transducer Index Number as its input source (see P201).

## Independent mA Setpoints (P210 and P211)

Use these features to reference the minimum and/or maximum mA output to any point in the measurement range.

P201—mA Function Settings	Action
Level, Space, or Distance	Enter the material level in Units (P005) or percent of Span (P007) as referenced to Empty (P006).
Volume	Enter the volume in Max Volume (P051) units or as a percent of Max Volume.
Volume Rate	Enter the volume rate in volume/min. Ensure the % symbol is displayed before attempting to enter a % value.
mA input or Communications Input	Not Applicable

### P210 0/4 mA Output Setpoint

*Sets the process level corresponding to the 0 or 4mA value.*

<b>Primary Index</b>	mA output
<b>Values</b>	Range: -999 to 9999
<b>Related</b>	<ul style="list-style-type: none"> <li>P211 20 mA Output Setpoint</li> </ul>

Enter the value (in applicable units or %) to correspond to 0 or 4 mA.

### P211 20 mA Output Setpoint

*Sets the process level that corresponds to the 20 mA value.*

<b>Primary Index</b>	mA output
<b>Values</b>	Range: -999 to 9999
<b>Related</b>	<ul style="list-style-type: none"> <li>P210 0/4 mA Output Setpoint</li> </ul>

Enter the value (in applicable units or %) to correspond to 20 mA.

## mA Output Limits (P212 and P213)

Use these features to adjust the minimum and/or maximum mA output values, which should suit the input limit requirements of the external device.

### P212 mA Output Min Limit

*Sets the minimum mA output value (in mA) to be produced.*

<b>Primary Index</b>	mA output
<b>Values</b>	Range: 0.000 to 22.00
	Preset: 0.0 or 3.8
<b>Related</b>	<ul style="list-style-type: none"> <li>P200 mA Output Range</li> <li>P213 mA Output Max Limit</li> </ul>

Preset is determined by mA Function (P200). If P200 = **1** or **3**, then the preset is **0.0**, or if P200 = **2** or **4**, then the preset is **3.8**. For P200=**1** or **3** (preset is 0.0), this parameter has no effect because the minimum limit cannot be negative, and the minimum current is always 0.0 mA.

## P213 mA Output Max Limit

*Sets the maximum mA output value (in mA) to be produced.*

<b>Primary Index</b>	mA output
<b>Values</b>	Range: 0.000 to 22.00
	Preset: 20.2 mA
<b>Related</b>	<ul style="list-style-type: none"> <li>P200 mA Output Range / P212 mA Output Min Limit</li> </ul>

## mA Output Trim (P214 to P215)

This does not affect the P203 value shown, and is used when recalibration of an external device is impractical.

### P214 4 mA Output Trim

*Calibrates the 4 mA output.*

<b>Primary Index</b>	mA output
<b>Values</b>	Range: -1.00 to 1.000
	Preset: 0.000
<b>Related</b>	<ul style="list-style-type: none"> <li>P215 20 mA Output Trim</li> </ul>

Adjust this value so the device indicates 4.000 mA when P214 is accessed.

### P215 20 mA Output Trim

*Calibrates the 20 mA output.*

<b>Primary Index</b>	mA output
<b>Values</b>	Range: -1.00 to 1.000
	Preset: 0.000
<b>Related</b>	<ul style="list-style-type: none"> <li>P214 4 mA Output Trim</li> </ul>

Adjust this value so the device indicates 20.00 mA when P215 is accessed.





# mA Output Failsafe (P219)

## P219 mA Output Failsafe

Use for failsafe operation, independent of the Failsafe Material Level (P071).

<b>Primary Index</b>	mA output	
<b>Values</b>	Range: 0.000 to 22.00	
	OFF	* mA output responds to Failsafe Material Level (P071).
	HOLd	last <b>known</b> value is held until normal operation resumes
	LO	produce the <b>Empty</b> mA output immediately
	HI	produce the <b>Span</b> mA output immediately
<b>Related</b>	• P201 mA Output Function	

### Selecting an independent mA Failsafe option:

1. Press MODE  to display the Auxiliary Function symbol.
2. Press ARROWS   to scroll access the failsafe options.
3. Press ENTER  when the desired option displayed.

Or, to produce an mA output at a specific value, enter the value required. This is used only if mA output is allocated to a transducer (P201 = 1 to 4).

## Standard Data Logging (P300 to P321)

All records can be reset by pressing the CLEAR   keys.

## Record Temperatures (P300 to P303)

These features display the high and/or low temperatures in °C. When a parameter relating to a TS-3 Temperature Sensor is accessed, the Index Type display changes to the TS-3 symbol .

If the unit is powered up without a temperature sensor connected, the value -50 °C is displayed. This information can help trace problems with both built in and external temperature sensors.

## P300 Temperature, Transducer Maximum

*Shows the highest temperature encountered, as measured by the temperature sensor in the transducer (if applicable).*

<b>Values</b>	Range: - 50 to 150°C (view only)
	Preset: - 50°C



Press CLEAR   keys to reset the log after a short circuit on the transducer wiring.



## P302 Temperature, Sensor Maximum

View the highest temperature encountered, as measured by the TS-3 Temperature Sensor (if applicable).

Values	Range: - 50 to 150°C (view only)
	Preset: - 50°C

Press CLEAR   keys to reset the log after a short circuit on the transducer wiring.

## Profile Records (P330 to P337)

**WARNING:** These parameters are for authorized service personnel or technicians familiar with Siemens Milltronics echo processing techniques.

These features can record up to ten Echo profiles, initiated manually (P330), or automatically (P331 et al) for viewing at a later time using Dolphin Plus or an oscilloscope. See *Scope Displays* (P810) for echo profile viewing hardware / software requirements. If ten Profiles are already saved, addresses 1 through 10 are filled, the oldest automatically initiated record is overwritten. Manually initiated records are not automatically overwritten. All records are automatically deleted in the event of a power interruption.

When a record is displayed, results are based on current programming (which may have been altered since the record was saved). This permits the effect on the echo profile to be observed when changing an echo parameter.

## P330 Profile Record



*Records profiles for later viewing.*

Primary Index	Echo profile	
Values	<b>Code</b>	<b>Description</b>
	----	no record
	A1	automatically recorded profile from Transducer One
	U1	manually recorded profile from Transducer One

**In addition to being a profile records library, this provides two functions:**

- manually records and saves echo profiles
- displays an echo profile, recorded manually or automatically (oscilloscope)

**To select a record address**

1. Enter PROGRAM mode and press DISPLAY  twice to highlight the index field. The field shows two underscores \_\_.
2. Type the index number. The profile record information is shown.
3. Use ARROWS   to scroll through the records.

### To manually record a profile

Press TRANSDUCER  to fire the transducer and record the echo profile into the internal scope buffer for display.

For differential or average operation (P001 = 4 or 5), access Scope Displays (P810) parameter to select the transducer number.

### To save a manual record



Press ENTER  to copy the echo profile record in the scope buffer and save it in the selected address in the record library. The parameter value field displays the new record information.

### To display a record

Press  key to enter display auxiliary mode.

Then press TRANSDUCER  to copy the current echo profile into the scope buffer for display on an oscilloscope or Dolphin Plus

### To delete a record

Press CLEAR  and then ENTER  to delete the echo profile record in the selected address. The value returns to - - - -.

## P331 Auto Record Enable

*Use to enable/disable the Auto Profile Record function.*

Values	Range: 0 to 1		
	0	*	Off
	1		On

## P333 Auto Record Interval

*Enter the time to elapse after an Auto Profile Record is saved before another Auto Profile Record can be saved (subject to all other restrictions).*

Values	Range: 0.0 to 9999 (minutes)	
	Preset: 120	

## Auto Record ON and OFF Setpoints (P334 to P337)

Use Auto Record ON Setpoint (P334) and Auto Record OFF Setpoint (P335) to define the boundaries within which the level must be, for the resultant Echo Profile to be considered for an Auto Profile Record.

If ---- is displayed for either P334 or P335, Auto Profile Records are saved regardless of current level (subject to all other restrictions).

Enter the level value in Units (P005) or percent of Span (P007) as referenced to Empty (P006).

## P334 Auto Record ON Setpoint

Enter the critical level which, in conjunction with Auto Record OFF Setpoint, defines the boundaries for Auto Profile Records to be saved.

<b>Values</b>	Range: -999 to 9999
<b>Related</b>	<ul style="list-style-type: none"> <li>• P335 Auto Record OFF Setpoint</li> <li>• P336 Auto Record Filling / Emptying</li> <li>• P337 Auto Record LOE Time</li> </ul>

## P335 Auto Record OFF Setpoint

Enter the critical level which, in conjunction with Auto Record ON Setpoint, defines the boundaries for Auto Profile Records to be saved.

<b>Values</b>	Range: -999 to 9999
<b>Related</b>	<ul style="list-style-type: none"> <li>• P334 Auto Record <b>ON</b> Setpoint</li> <li>• P336 Auto Record Filling / Emptying</li> <li>• P337 Auto Record LOE Time</li> </ul>

## P336 Auto Record Filling / Emptying

Use this feature to restrict Auto Profile Records from being saved unless the level is rising, falling or either.

<b>Values</b>	0	*	Auto Profile Record on filling or emptying
	1		Auto Profile Record on filling only
	2		Auto Profile Record on emptying only
<b>Related</b>	<ul style="list-style-type: none"> <li>• P334 Auto Record ON Setpoint</li> <li>• P335 Auto Record OFF Setpoint</li> <li>• P337 Auto Record LOE Time</li> <li>• P702 Filling Indicator</li> <li>• P703 Emptying Indicator</li> </ul>		

If the level changes at a rate in excess of the corresponding Filling / Emptying Indicator (P702 / P703) values, the Echo Profile is saved subject to this and other Auto Profile Record restrictions.

## P337 Auto Record LOE Time

Limits Auto Profile Records from being saved unless extended LOE occurs.

<b>Values</b>	Range: 0.0 to 9999 (seconds)
	Preset: 0.0
<b>Related</b>	<ul style="list-style-type: none"> <li>• P334 Auto Record ON Setpoint</li> <li>• P335 Auto Record OFF Setpoint</li> <li>• P336 Auto Record Filling / Emptying</li> </ul>

If the LOE condition exceeds the period entered, the Echo Profile is saved. When set for **0** LOE is not required for an Auto Profile Record to be saved.

## Installation Records (P340 to P342)

### P340 Date of Manufacture

*View the date of manufacture of this SITRANS LU01 unit.*

<b>Values</b>	Format: YY:MM:DD (view only)
<b>Related</b>	<ul style="list-style-type: none"> <li>• P341 RUN Time</li> <li>• P342 Start Ups</li> </ul>

### P341 RUN Time

*View the number of days this SITRANS LU01 has been in operation.*

<b>Values</b>	Range: 0.000 to 9999 (view only)
<b>Related</b>	<ul style="list-style-type: none"> <li>• P340 Date of Manufacture</li> <li>• P342 Start Ups</li> </ul>

The RUN Time value is updated once a day, and cannot be reset. However, in the event of a power interruption, the counter won't advance. Therefore, a unit that is powered down on a regular basis will not have an accurate value.

### P342 Start Ups

*The number of times power has been applied since the Date Of Manufacture.*

<b>Values</b>	Range: 1 to 9999 (view only)
<b>Related</b>	<ul style="list-style-type: none"> <li>• P340 Date of Manufacture</li> <li>• P341 RUN Time</li> </ul>

## Range Calibration (P650 to P654)

There are two types of calibration possible:

**Offset:** Adjusts the measurements by a fixed amount.

**Sound Velocity:** Adjusts speed of sound and changes the measurement calculations.

Do Offset calibration at any steady level unless a Sound Velocity calibration is also done. If both calibrations are done then do Offset at a known high level and Sound Velocity at a known low level.

### P650 Offset Calibration

*Calibrates Empty (P006) if the reported level is consistently high or low by a fixed amount.*

<b>Values</b>	Range: -999 to 9999
<b>Related</b>	<ul style="list-style-type: none"> <li>• P006 Empty</li> <li>• P062 Offset Reading</li> <li>• P652 Offset Correction</li> <li>• P664 Temperature</li> </ul>

**Before using this feature, verify the following parameters are correct:**

- Empty (P006)
- Temperature (P664)
- Offset Reading (P062)

### Offset Calibration

Begin with a steady level.

1. Press TRANSDUCER  to display the calculated reading.
2. Repeat Step One at least five times to verify repeatability.
3. Measure the actual reading (use tape measure).
4. Enter the actual value.

The deviation between the entered Empty (P006) value and the calibrated **Empty** value is stored in Offset Correction (P652).

## P651 Sound Velocity Calibration

*Changes the speed of sound constant.*

<b>Values</b>	Range: -999 to 9999
<b>Related</b>	<ul style="list-style-type: none"> <li>• P653 Velocity</li> <li>• P654 Velocity at 20°C</li> </ul>

### Condition for use of this feature

- The acoustic beam atmosphere is other than air
- The acoustic beam atmosphere temperature is unknown
- The Reading accuracy is acceptable at higher material levels only

For best results, calibrate with the level at a known value near empty.

### Using Sound Velocity Calibration

Ensure a steady level at some low value (P653 and P654 adjusted accordingly)

1. Allow sufficient time for the vapor concentration to stabilize.
2. Press TRANSDUCER  to display the calculated reading.
3. Repeat Step Two at least five times to verify repeatability.
4. Measure the actual reading (e.g. with a tape measure).
5. Enter the actual value.

Repeat this procedure if the atmosphere type, concentration, or temperature conditions are different from when the last sound velocity calibration was performed.

**Note:** In gasses other than air, the temperature variation may not correspond with the speed of sound variation. Turn off temperature sensor and use a fixed temperature.

## P652 Offset Correction

*The value altered when an Offset Calibration is performed.*

<b>Values</b>	Range: -999 to 9999
<b>Related</b>	<ul style="list-style-type: none"> <li>• P650 Offset Calibration</li> </ul>

Alternatively, if the amount of Offset Correction required is known, enter the amount to be added to the Reading before display.

## P653 Velocity

*The value adjusted based on the Sound Velocity at 20 °C (P654) vs. Temperature (P664) characteristics of air.*

<b>Values</b>	Range: 50.01 to 2001 m/s (164.1 to 6563 ft/s)
<b>Related</b>	<ul style="list-style-type: none"> <li>• P651 Sound Velocity Calibration</li> <li>• P654 Velocity at 20°C</li> </ul>

Alternatively, enter the current sound velocity (if known), or perform a Sound Velocity Calibration (P651). The units used are m/s if P005 = 1, 2, or 3, or ft/s if P005 = 4 or 5.

## P654 Velocity at 20°C

*This value is used to automatically calculate Sound Velocity (P653).*

<b>Values</b>	Range: 50.01 to 2001 m/s (164.1 to 6563 ft/s)
<b>Related</b>	<ul style="list-style-type: none"> <li>• P005 Units</li> <li>• P651 Sound Velocity Calibration</li> <li>• P653 Velocity</li> </ul>

After performing a Sound Velocity Calibration, check this value to verify the acoustic beam atmosphere is **air** (344.1 m/s or 1129 ft/s).

Alternatively, if the acoustic beam atmosphere sound velocity at 20°C (68 °F) is known, and the sound velocity vs. temperature characteristics are similar to that of **air**, enter the sound velocity.

The units used are m/s if P005 = 1, 2, or 3, or ft/s if P005 = 4 or 5.

# Temperature Compensation (P660 to P664)

## P660 Temp Source

*Source of the temperature reading used to adjust the speed of sound.*

<b>Values</b>	1	*	AUTO
	2		Temp Fixed
	3		Ultrasonic/Temperature Transducer
	4		TS-3 Temperature Sensor
	5		Average (TS-3 and transducer)
<b>Alters</b>	<ul style="list-style-type: none"> <li>• P664 Temperature</li> </ul>		
<b>Related</b>	<ul style="list-style-type: none"> <li>• P651 Sound Velocity</li> <li>• P653 Velocity</li> <li>• P654 Velocity at 20°C</li> <li>• P661 Temp Fixed</li> </ul>		

The SITRANS LU01 uses the TS-3 temperature sensor assigned to the transducer. If one is not connected, the ultrasonic/temperature transducer is used. If the transducer does not have an internal temperature sensor, the Temp Fixed (P661) value is used.

If the acoustic beam atmosphere temperature varies with distance from the transducer, connect a TS-3 Temperature Sensor and ultrasonic / temperature transducer, and select **average**.

## P661 Temp Fixed

*Use this feature if a temperature sensing device is not used.*

<b>Values</b>	Range: -199 to 199 (preset = 20 °C)
<b>Related</b>	<ul style="list-style-type: none"> <li>• P651 Sound Velocity Calibration</li> <li>• P653 Velocity</li> <li>• P654 Velocity at 20°C</li> <li>• P660 Temp Source</li> </ul>

Enter the temperature (in °C) of the atmosphere within the transducer acoustic beam. If the temperature varies with distance from the transducer, enter the average temperature.

## P664 Temperature

*View the transducer temperature in °C.*

<b>Values</b>	Range: -50 to 150 (view only)
<b>Altered By</b>	<ul style="list-style-type: none"> <li>• P660 Temp Source</li> </ul>
<b>Related</b>	<ul style="list-style-type: none"> <li>• P651 Sound Velocity Calibration</li> <li>• P653 Velocity</li> <li>• P654 Velocity at 20°C</li> <li>• P661 Temp Fixed</li> </ul>

Value is displayed when  is pressed in RUN mode.

If Temp Source (P660) is set to any value other than Fixed Temp, the value displayed is the temperature measured. If Temp Source is set to Fixed Temp, the P661 value is displayed.

## Rate (P700 to P707)

These parameters determine how material level changes are reported.

### P700 Max Fill Rate

*Adjusts the SITRANS LU01 response to increases in the actual material level (or advance to a higher Failsafe Material Level, P071).*

<b>Values</b>	Range: 0.000 to 9999
<b>Altered by</b>	<ul style="list-style-type: none"> <li>• P003 Maximum Process Speed</li> </ul>
<b>Related</b>	<ul style="list-style-type: none"> <li>• P005 Units</li> <li>• P007 Span</li> <li>• P071 Failsafe Material Level</li> </ul>

Enter a value slightly greater than the maximum vessel filling rate. This value, in Units (P005) or % of Span (P007) per minute, is automatically altered when Maximum Process Speed (P003) is altered.

P003 Value	Meters/Minute
1	0.1
2	1
3	10

### P701 Max Empty Rate

*Adjusts the SITRANS LU01 response to decreases in the actual material level (or advance to a lower Failsafe Material Level, P071).*

<b>Values</b>	Range: 0.000 to 9999
<b>Altered by</b>	<ul style="list-style-type: none"> <li>• P003 Maximum Process Speed</li> </ul>
<b>Related</b>	<ul style="list-style-type: none"> <li>• P005 Units</li> <li>• P007 Span</li> <li>• P071 Failsafe Material Level</li> </ul>

Enter a value slightly greater than the maximum vessel emptying rate. This value, in Units (P005) or % of Span (P007) per minute, is automatically altered when Maximum Process Speed (P003) is altered.

P003 Value	Meters / Minute
1	0.1
2	1
3	10



## P702 Filling Indicator

*The fill rate required to activate the LCD Filling indicator (↑).*

<b>Values</b>	Range: -999 to 9999
<b>Altered by</b>	<ul style="list-style-type: none"> <li>P003 Maximum Process Speed</li> </ul>
<b>Related</b>	<ul style="list-style-type: none"> <li>P005 Units</li> <li>P007 Span</li> <li>P700 Max Fill Rate</li> </ul>

This value (in Units (P005) or % of Span (P007) per minute) is automatically set to 1/10 of the Max Fill Rate (P700).

## P703 Emptying Indicator

*The empty rate required to activate the LCD Emptying indicator (↓).*

<b>Values</b>	Range: -999 to 9999
<b>Altered by</b>	<ul style="list-style-type: none"> <li>P003 Maximum Process Speed</li> </ul>
<b>Related</b>	<ul style="list-style-type: none"> <li>P005 Units</li> <li>P007 Span</li> <li>P701 Max Empty Rate</li> </ul>

This value (in Units (P005) or % of Span (P007) per minute) is automatically set to 1/10 of the Max Empty Rate (P701).

## P704 Rate Filter

*Damps Rate Value (P707) fluctuations.*

<b>Values</b>	0	Rate display not required
	Filtered Output	
	1	Continuously filtered and updated
	Interval Output	
	2	1 minute or 50 mm (2 in)
	3	5 minutes or 100 mm (3.9 in)
	4	10 minutes or 300 mm (11.8 in)
5	10 minutes or 1000 mm (39.4 in)	
<b>Alters</b>	<ul style="list-style-type: none"> <li>P707 Rate Value</li> </ul>	
<b>Altered by</b>	<ul style="list-style-type: none"> <li>P003 Maximum Process Speed</li> </ul>	
<b>Related</b>	<ul style="list-style-type: none"> <li>P705 Rate Update Time/ P706 Rate Update Distance</li> </ul>	

Enter the time or distance interval over which the Rate Value is to be calculated before the display updates.

This is automatically altered along with Maximum Process Speed (P003).

This value automatically alters the Rate Update Time (P705) and / or Rate Update Distance (P706). Alternatively, these parameter values may be altered independently.

## P705 Rate Update Time

*The time period (in seconds) over which the material level rate of change is averaged before Rate Value update.*

<b>Values</b>	Range: 0.000 to 9999
<b>Related</b>	• P707 Rate Value

## P706 Rate Update Distance

*The material level change (in metres) to initiate a Rate Value update.*

<b>Values</b>	Range: 0.000 to 9999
<b>Related</b>	• P707 Rate Value

## P707 Rate Value

*The rate of material level change (in Units (P005) or % of Span (P007) per minute).*

<b>Values</b>	Range: -999 to 9999 (view only)
<b>Altered By</b>	• P704 Rate Filter
<b>Related</b>	• P005 Units • P007 Span

A negative rate indicates the vessel is emptying.

This is the value displayed when  is pressed in RUN mode.

## Measurement Verification (P710 to P713)

### P710 Fuzz Filter

*Use this to stabilize the reported level, due to level fluctuations (such as a rippling or splashing liquid surface) within the Echo Lock Window (P713).*

<b>Values</b>	Range: 0 to 100 (0 = off)
<b>Altered by</b>	• P003 Maximum Process Speed
<b>Related</b>	• P007 Span • P713 Echo Lock Window

This value (in % of Span, P007) is automatically altered when Maximum Process Speed (P003) is altered. The higher the value entered, the greater the fluctuation stabilized.

## P711 Echo Lock

Use this feature to select the measurement verification process.

<b>Values</b>	0		Off
	1		Maximum verification
	2	*	Material agitator
	3		Total lock
<b>Related</b>	<ul style="list-style-type: none"> <li>• P700 Max Fill Rate</li> <li>• P701 Max Empty Rate</li> <li>• P712 Echo Lock Sampling</li> <li>• P713 Echo Lock Window</li> <li>• P820 Algorithm</li> </ul>		

If a material agitator (mixer) is used in the vessel monitored, set Echo Lock for **maximum verification** or **material agitator** to avoid agitator blade detection. Ensure the agitator is always ON while the SITRANS LU01 is monitoring the vessel to avoid stationary blade detection.

When set for **max verification** or **material agitator**, a new measurement outside of the Echo Lock Window (P713) must meet the sampling criterion (P712).

For **total lock**, Echo Lock Window (P713) is preset to zero **0**. The SITRANS LU01 continuously searches for the best echo according to the algorithm chosen (P820). If the selected echo is within the window, the window is then centered about the echo. If not, the window widens with each successive shot until the selected echo is within the window. The window then returns to its normal width.

When Echo Lock is OFF, the SITRANS LU01 responds immediately to a new measurement as restricted by the Max Fill / Empty Rate (P700 / P701); however, measurement reliability is affected.

## P712 Echo Lock Sampling

*The sampling criterion sets the number of consecutive echoes appearing above or below the echo currently locked onto, that must occur before the measurements are validated as the new reading (for Echo Lock P711 values: 1 or 2).*

<b>Values</b>	Range: 1:1 to 99:99	
	Format: x:y	
	x = the number of <b>above</b> echoes	
	y = the number of <b>below</b> echoes	
<b>Related</b>	<ul style="list-style-type: none"> <li>• P711 Echo Lock</li> </ul>	

P711 value	P712 preset value
1, max verification	5:5
2, material agitator	5:2

**Example:****Setting**

- P711 = 2, material agitator
- P712 = 5:2

**Result**

- a new reading will not be validated unless five consecutive measurements higher or two consecutive measurements lower than the current reading occur
- Resetting P711 returns P712 to the respective preset values

## P713 Echo Lock Window

*Adjusts the size of the Echo Lock Window.*

<b>Values</b>	Range: 0.000 to 9999
	Preset: 0.000
<b>Altered by</b>	<ul style="list-style-type: none"> <li>• P003 Maximum Process Speed</li> </ul>
<b>Related</b>	<ul style="list-style-type: none"> <li>• P005 Units</li> <li>• P711 Echo Lock</li> </ul>

The Echo Lock Window is a **distance window** (units P005) centred on the echo and used to derive the Reading. When a new measurement is in the window, it is re-centred and the new Reading calculated. Otherwise, the new measurement is verified by Echo Lock (P711) before the reading is updated.

When **0** is entered the window is automatically calculated after each measurement. For slower P003 Maximum Process Speed values the window is narrow, for faster P003 values the window becomes wider.

## Transducer Scanning (P725 to P729)

### P726 Level System Sync

*Enables the System Sync on the terminal block.*

<b>Values</b>	0	not required
	1	* synchronize level monitors

Use this if another level measurement system is mounted nearby, and they are wired together on the Sync terminal.

### P727 Scan Delay

*The delay, in seconds, between measurements from transducer points.*

<b>Values</b>	Range: 0.000 to 60.00
	Preset: 5.0
<b>Altered by</b>	<ul style="list-style-type: none"> <li>• P003 Maximum Process Speed</li> </ul>
<b>Related</b>	<ul style="list-style-type: none"> <li>• P001 Operation</li> </ul>

This feature may only be used to adjust the delay before the next point is scanned. Enter the amount of delay in seconds. This value is automatically altered when Maximum Process Speed (P003) is altered.

## P728 Shot Delay

*The delay, in seconds, between transducer shots.*

<b>Values</b>	Range: 0.1 to 4.0
	Preset: 0.5

Use this if transient acoustic noise within the vessel is causing measurement difficulties due to echoes from one shot being received on the next. If more than one ultrasonic unit is installed for redundancy, this value should be **0**.

## P729 Scan Time

*View the elapsed time (in seconds) since the point displayed was last scanned.*

<b>Values</b>	Range: 0.000 to 9999 (view only)
<b>Related</b>	• P001 Operation

This may be viewed as an Auxiliary Reading in the RUN mode.

## Display (P730 to P733)





### P730 Auxiliary Reading

*Use this feature to display operator selected Auxiliary Readings temporarily or indefinitely (as desired).*

<b>Values</b>	Range: 000 to 999
	Display: OFF, HOLD

Select **OFF** to display Auxiliary Readings temporarily. Select **HOLD** to display Auxiliary Readings until another Auxiliary Reading is selected or programming mode is entered. See the *Keypad* section on page 24 for RUN mode auxiliary readings.

#### Selecting the Auxiliary Reading operation

1. Press READING  to display the Auxiliary Function symbol.
2. Press ARROWS   to access the OFF or HOLD option desired.
3. Press ENTER .

If necessary, enter the Parameter Number to default in the Auxiliary Reading display. That value will show in the auxiliary reading area by default. Other values are available but will reset to the parameter defined here.

## P731 Auxiliary Reading Key

Enter the Parameter Number whose value is to be displayed in the Auxiliary Reading field

Values	Range: 000 to 999
	Preset: Material Reading, P921

 is pressed in the RUN mode. See the *Keypad* section on page 24 for RUN mode auxiliary readings.

## P732 Display Delay

Adjusts the Point Number display scroll speed.



Values	Range: 0.5 to 10
	Preset: 1.5 seconds
Related	<ul style="list-style-type: none"> <li>P001 Operation</li> </ul>

Use this feature to adjust the delay before the display advances to the next Point Number. Display scrolling is independent from transducer scanning.

## P733 Scroll Access

Use this feature to select the parameter scroll access option desired.

Values	0	Off	to scroll to all parameters (P001 to P999)
	1	* Smart	for Quick Start, altered, and tagged parameters
	2	Tagged	to scroll to operator tagged parameters only

Press READING  and  to tag / untag any accessed parameter.  is displayed to indicate the parameter accessed is tagged.

**Note:** Quick Start parameters (P001 – P007) and those changed from factory default settings cannot be untagged.

# Peripheral Communication Support Parameters (P740 to P749)

## P740 Peripheral Communications

Use this feature to select the SITRANS LU01 to communication message format.

Values	0		Off	if comm port is not used, OFF increases LU01 processing speed.
	1	*	normal messages (preset)	messages transmitted as a continuous string of characters
	2		formatted messages	commas inserted between message fields for easier message distinction

**Note:** Refer to Technical Reference / Communication Support on page 94 if Peripheral Communication is required.

## P748 RS-485 Termination

Single point termination may be required to minimize transmission reflections, on long cable runs typical of 500 m or more.

Values	0	*	Off	
	1		on	

## P749 Serial Bus Type

Displays the type of communication bus the SITRANS LU01 is currently set for. If there is no connection, the SITRANS LU01 defaults to RS-485. If a bus type other than RS-485 is connected, the SITRANS LU01 displays the type of bus it is, or is attempting to, communicate with.

Values (view only)	232		RS-232
	485	*	RS-485: default when nothing is connected
	bPL		bipolar current loop
	rJ11		for Siemens Milltronics use

## SmartLinx Reserved (750 to 769)

These parameters are reserved for optional SmartLinx communications cards and vary by card. Refer to the SmartLinx documentation to determine if any of them are used.

## Communications (P772)

The SITRANS LU01 communication ports are configured by a series of parameters that are indexed by port.

Communication parameters are indexed to these communication ports, unless otherwise noted:

Port	Description
1	RS-232 port (RJ-11 modular telephone)
2	RS 485 port on terminal block

## P772 Baud Rate

*The communication rate with the master device.*

Primary Index	Communications Port		
Values	4.8	*	4800 baud
	9.6		9600 baud
	19.2		19,200 baud
	115.2		115,200 baud

This specifies the rate of communication in baud. Any value may be entered but only the values shown above are supported. The baud rate should reflect the speed of the connected hardware and protocol used.

## SmartLinx Hardware Testing

These parameters are used to test and debug a SmartLinx card (if installed).

## P790 Hardware Error

*The results of ongoing hardware tests in the communications circuitry.*

Values	PASS	*	No errors
	FAIL		faulty SmartLinx module or SITRANS LU01
	ERR1		unknown protocol; upgrade the LU01 software
Related	<ul style="list-style-type: none"> <li>P791 Bus Error</li> <li>P792 Bus Error Count</li> </ul>		

If any test does not meet the PASS requirements, communication halts and tests are repeated until PASS requirements are met. Communication then resumes. If **FAIL** or **ERR1** is displayed in P790 (Hardware Error), go to P791 (Bus Error) for information about the error.



## P791 Bus Error

*Indicates if an error condition is occurring on the bus.*

<b>Values</b>	0	*	No error
	Any other value		Error code; refer to SmartLinx module documentation for explanation of error code.
<b>Related</b>	<ul style="list-style-type: none"> <li>P790 Hardware Error</li> </ul>		

## P792 Bus Error Count

*A count that increments by 1 each time a bus error (P791) is reported.*

<b>Values</b>	Range: 0* to 9999		
	Error count; provide this number to your Siemens Milltronics representative for troubleshooting.		
<b>Related</b>	<ul style="list-style-type: none"> <li>P790 Hardware Error</li> </ul>		

## P794 SmartLinx Module Type

*This parameter is used to identify the module type when SmartLinx is used. If you are not using SmartLinx, this parameter is not functional. Please see the associated SmartLinx instruction manual for a full description of this parameter.*

## P795 SmartLinx Protocol

*This parameter is used to identify the protocol when SmartLinx is used. If you are not using SmartLinx, this parameter is not functional. Please see the associated SmartLinx instruction manual for a full description of this parameter.*

## Echo Processing (P800 to P807)

### P800 Near Blanking

*The space near the transducer face which cannot be measured.*

<b>Values</b>	Range: 0.000 to 9999		
	Preset: transducer dependent		
<b>Altered by</b>	<ul style="list-style-type: none"> <li>P004 Transducer</li> </ul>		
<b>Related</b>	<ul style="list-style-type: none"> <li>P006 Empty</li> <li>P007 Span</li> <li>P833 TVT Start Min</li> </ul>		

Use this feature if the surface is reported to be near the transducer face but is in fact much further away. Extend this value when changing transducer location, mounting, or aiming.

Please note that changing the Near Blanking cannot correct measurement problems. Ensure that Span (P007) < Empty (P006) minus Near Blanking (P800).

## P801 Range Extension

*Used if incorrect level is reported (when material level is lower than Empty, P006).*

<b>Values</b>	Range: 0.000 to 9999		
	Preset: 20% of Span (P007)		
<b>Related</b>	<ul style="list-style-type: none"> <li>• P005 Units</li> <li>• P006 Empty</li> <li>• P007 Span</li> <li>• P004 Transducer</li> </ul>		

Range extension is the distance in Units (P005) or % of Span (P007) beyond Empty, which is still ultrasonically measurable. If empty is substantially higher than the actual vessel bottom, increase Range Extension such that Empty plus Range Extension is greater than the transducer to vessel bottom distance.

## P802 Transducer with Submergence Shield

*Used when the transducer is expected to be submerged on occasion.*

<b>Values</b>	0	*	Off
	1		Submergence transducer
<b>Related</b>	<ul style="list-style-type: none"> <li>• P006 Empty</li> <li>• P071 Failsafe Material Level</li> <li>• Relays</li> </ul>		

When a transducer with a submergence shield is submerged, the shield traps an air pocket that creates a special echo. The SITRANS LU01 recognizes the echo and advances the reading to the highest level and operates displays and outputs accordingly. This feature is effective for when power is returned while the transducer is submerged.

## P803 Shot / Pulse Mode

*Determines what type of ultrasonic shots are fired.*

<b>Values</b>	1		Short
	2	*	Short and long
<b>Related</b>	<ul style="list-style-type: none"> <li>• P006 Empty</li> <li>• P805 Echo Confidence</li> <li>• P804 Confidence Threshold</li> <li>• P852 Short Shot Range</li> </ul>		

Increases SITRANS LU01 response when the monitored surface is close to the transducer face. Select **short and long** to have short and long acoustic shots fired for each measurement, regardless of the transducer to surface distance. Select **short** to have only short shots fired if the Echo Confidence (P805) produced by a short shot exceeds the short Confidence Threshold (P804) and the monitored surface is always within the Short Shot Range (P852).

## P804 Confidence Threshold

*Determines which echoes are evaluated by software.*

<b>Values</b>	Range: x.y [x = short (0 to 99), y = long (0 to 99)]
	Preset: 10:5
<b>Related</b>	<ul style="list-style-type: none"> <li>P805 Echo Confidence</li> </ul>

The short and long shot Confidence Thresholds are preset to 10 and 5 respectively. When Echo Confidence (P805) exceeds the Confidence Threshold, the echo is evaluated by Sonic Intelligence. Values are entered as two numbers separated by a decimal point. The first number is the short shot confidence and the second number is the long shot confidence.

**Note:** The decimal point is replaced with a colon (:) on the display.

## P805 Echo Confidence

*Displays the echo confidence of the measurement echo from the last shot.*

<b>Values</b>	Format: x:y (view only)
	x = short (0 to 99)
	y = long (0 to 99)
<b>Related</b>	<ul style="list-style-type: none"> <li>P804 Confidence Threshold</li> <li>P830 TVT Type</li> </ul>

Use this feature to monitor the effect of transducer aiming, location, and mechanical transducer / mounting isolation.

Both short and long shot Echo Confidence is displayed. (To display this value in the auxiliary display while the unit is running, press  for 4 seconds.)

Display	Description
<b>X:--</b>	short shot confidence value, (long shot not used).
<b>--:Y</b>	long shot confidence value, (short shot not used).
<b>X:Y</b>	short and long shot confidence values (both used).
<b>E</b>	transducer cable is open or short circuited.
<b>--:--</b>	no shots were processed for Sonic Intelligence evaluation.

## P806 Echo Strength

Displays the strength (in dB above 1  $\mu$ V rms) of the echo which was selected as the measurement echo.

Values	Format: 0 to 99 (view only)
--------	-----------------------------

## P807 Noise

Displays the average and peak ambient noise (in dB above 1  $\mu$ V rms) being processed.

Values	Format: x:y (view only)
	x = average (-99 to 99)
	y = peak (-99 to 99)

The noise level is a combination of transient acoustic noise and electrical noise (induced into the transducer cable or receiving circuitry). See *Noise Problems* in the *Troubleshooting* Section on page 99.

## Advanced Echo Processing (P810 to P825)

**Note:** The following parameters are for authorized Siemens Milltronics Service personnel or technicians familiar with Siemens Milltronics echo processing techniques.

### Anatomy of an Echo Profile

The relevant parts of an echo profile are listed here. These are visible in either Dolphin Plus or an oscilloscope.

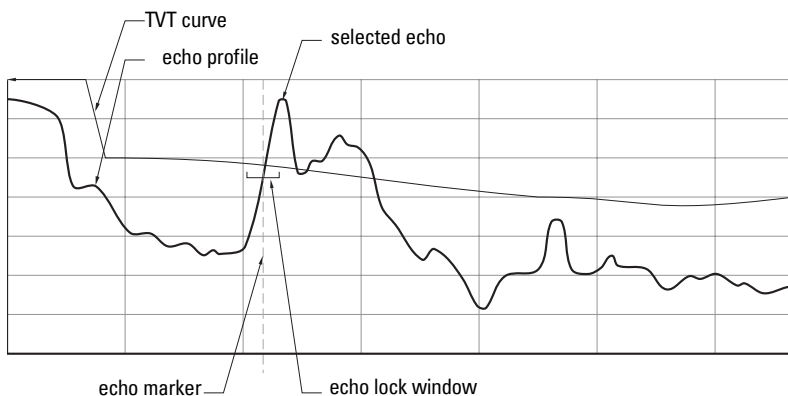

# P810 Scope Displays

*Captures echo profiles for display on an oscilloscope.*

<b>Values</b>	Display: P, C, n, u, _
	Preset: _ _ _ _ (display is off)
<b>Related</b>	<ul style="list-style-type: none"> <li>P832 TVT Shaper Adjust</li> </ul>

Use this feature to monitor the effects of Echo Processing changes.

Connect an oscilloscope to Display Board TP4, TP5, and TP6.

Sweep = 10 us / div. to 1 ms / div. (x 100 for real time)

Amplitude = 1 V / div.

Trigger = external

**Note:** Use of an analog oscilloscope is preferred over a digital oscilloscope.

**Any combination of the following Scope Displays is available.**

Display	Symbol			
	P	C	n	u
Echo Profile	▲	▲	▲	▲
TVT Curve		▲	▲	▲
Echo Marker			▲	▲
Echo Lock Window				▲

## Two methods to select Scope Displays:

### Scrolling

- Press READING  $\left[ \frac{\Delta}{\%} \right]$  to display the Auxiliary Function symbol.
- Press ARROWS  $\left[ \uparrow \downarrow \right]$  to access the desired Reading display symbols.
- Press ENTER  $\left[ \leftarrow \right]$  with the desired display symbols displayed.

### 1/0 Values

Alternatively, a four-digit binary value may be entered, where a **0** turns the associated signal display OFF, and a **1** turns the display ON.

**1110 = PCn\_ :**

- Echo Profile, TVT Curve, and Echo Marker displays ON
- Echo Lock Window display OFF

Use the Scope Displays after pressing TRANSDUCER  $\left[ \downarrow \right]$  to observe the result of parameter alterations. Take several measurements to verify repeatability and overcome Echo Lock (P711) restrictions.

## P816 Echo Time Raw

*The time (in ms) from the transmit pulse to the processed echo.*



<b>Values</b>	Range: 0.0 to 9999 (view only)
---------------	--------------------------------

## Profile Pointer (P817 to P825)

When one of these parameters is accessed, the scope display changes: The Echo Lock Window becomes the Profile Pointer. The Profile Pointer may be moved to any point on the Echo Profile to gain specific information about the profile according to the selected parameter.

To move the Profile Pointer to a specific point, enter the desired value and it will move to the nearest acceptable Echo Profile point.

Alternatively, to scroll the Profile Pointer along the Echo Profile:

1. Press  to display the Auxiliary Function symbol.
2. Press  or  to move the Profile Pointer to the left or right respectively.
3. When the Profile Pointer Parameters are exited and RUN mode is entered, the scope display automatically changes back to include the Echo Lock Window.

## P817 Profile Pointer Time

*The time (in ms) from the transmit pulse to the Profile Pointer.*

<b>Values</b>	Range: 0.000 to 9999 (view only)
<b>Related</b>	<ul style="list-style-type: none"> <li>• P818 Profile Pointer Distance</li> <li>• P819 Profile Pointer Amplitude</li> <li>• P820 Algorithm</li> <li>• P821 Spike Filter</li> <li>• P822 Narrow Echo Filter</li> <li>• P823 Reform Echo</li> <li>• P825 Echo Marker Trigger</li> </ul>

## P818 Profile Pointer Distance

*The distance between the transducer face and the Profile Pointer.*

<b>Values</b>	Range: 0.000 to 9999 (view only)
<b>Related</b>	<ul style="list-style-type: none"> <li>• P817 Profile Pointer Time</li> <li>• P819 Profile Pointer Amplitude</li> <li>• P820 Algorithm</li> <li>• P821 Spike Filter</li> <li>• P822 Narrow Echo Filter</li> <li>• P823 Reform Echo</li> <li>• P825 Echo Marker Trigger</li> </ul>

## P819 Profile Pointer Amplitude

The amplitude (in dB above 1  $\mu$ V) of the Echo Profile at the Pointer position.





<b>Values</b>	Range: 00 to 99 (view only)
<b>Related</b>	<ul style="list-style-type: none"> <li>• P817 Profile Pointer Time</li> <li>• P818 Profile Pointer Distance</li> <li>• P820 Algorithm</li> <li>• P821 Spike Filter</li> <li>• P822 Narrow Echo Filter</li> <li>• P823 Reform Echo</li> <li>• P825 Echo Marker Trigger</li> </ul>

## P820 Algorithm

Chooses the algorithm to generate the measured value from the profile.

<b>Values</b>	1	ALF = long range Area, Largest, and First average (general purpose, solids)
	2	A = long range Area only (coarse, heaped solids)
	3	L = long range Largest only (liquids, open vessels)
	4	F = long range First only (liquids, closed vessel)
	5	AL = long range Area and Largest average (fine heaped solids)
	6	AF = long range Area and First average (coarse flat solids)
	7	LF = long range Largest and First average (general purpose, liquids)
	8	* bLF = short range Largest or First (general purpose)
	9	bL = short range Largest only (solids and open vessel liquids)
	10	bF = short range First only (closed vessel liquids)
<b>Related</b>	<ul style="list-style-type: none"> <li>• P805 Echo Confidence</li> <li>• P817 Profile Pointer Time</li> <li>• P818 Profile Pointer Distance</li> <li>• P819 Profile Pointer Amplitude</li> <li>• P821 Spike Filter</li> <li>• P822 Narrow Echo Filter</li> <li>• P823 Reform Echo</li> <li>• P825 Echo Marker Trigger</li> </ul>	

Use this to select the algorithm(s) the Sonic Intelligence echo selection is based on. Use P805 Echo Confidence (page 69) to determine which algorithm gives the highest confidence under all level conditions. If the wrong echo is processed, observe the echo processing displays and select an alternate algorithm, either by entering the numeric value desired, or as below:

1. Press MEASURE  to display the Auxiliary Function symbol.
2. Press ARROWS   to access the desired Reading display symbols.
3. Press ENTER  when the required algorithm is displayed.

## P821 Spike Filter

*Dampens spikes in the echo profile to reduce false readings.*

<b>Values</b>	0		Off
	1	*	On
<b>Related</b>	<ul style="list-style-type: none"> <li>• P817 Profile Pointer Time</li> <li>• P818 Profile Pointer Distance</li> <li>• P819 Profile Pointer Amplitude</li> <li>• P820 Algorithm</li> <li>• P822 Narrow Echo Filter</li> <li>• P823 Reform Echo</li> <li>• P825 Echo Marker Trigger</li> </ul>		

Use P821 if interference spikes are on the long shot Echo Profile display.

## P822 Narrow Echo Filter

*Filters out echoes of a specific width. Enter width of false echo in msec.*

<b>Values</b>	0 = OFF (preset)		
	greater = wider		
<b>Related</b>	<ul style="list-style-type: none"> <li>• P817 Profile Pointer Time</li> <li>• P818 Profile Pointer Distance</li> <li>• P819 Profile Pointer Amplitude</li> <li>• P820 Algorithm</li> <li>• P821 Spike Filter</li> <li>• P823 Reform Echo</li> <li>• P825 Echo Marker Trigger</li> </ul>		

Use this for transducer acoustic beam interference (e.g. ladder rungs). Enter the width of false echoes (in ms) to be removed from the long shot Echo Profile. When a value is keyed in, the nearest acceptable value is entered.

## P823 Reform Echo

*Smooths jagged peaks in the echo profile. Reforms fragmented echoes into one.*

<b>Values</b>	0 = OFF (preset)		
	greater = wider		
<b>Related</b>	<ul style="list-style-type: none"> <li>• P002 Material</li> <li>• P817 Profile Pointer Time</li> <li>• P818 Profile Pointer Distance</li> <li>• P819 Profile Pointer Amplitude</li> <li>• P820 Algorithm</li> <li>• P821 Spike Filter</li> <li>• P822 Narrow Echo Filter</li> <li>• P825 Echo Marker Trigger</li> </ul>		



Use this feature, when monitoring solids (P002 = 2), if the reported level fluctuates slightly, though the monitored surface is still. Enter the amount (in ms) of long shot Echo Profile smoothing required. When a value is keyed in, the nearest acceptable value is entered.

## P825 Echo Marker Trigger

*The point on the primary echo on which the measured value is based.*

<b>Values</b>	Range: 5 to 95%
	Preset: 90% when P002=1 (Liquid) or 50% when P002=2 (Solid)
<b>Related</b>	<ul style="list-style-type: none"> <li>• P817 Profile Pointer Time</li> <li>• P818 Profile Pointer Distance</li> <li>• P819 Profile Pointer Amplitude</li> <li>• P820 Algorithm</li> <li>• P821 Spike Filter</li> <li>• P822 Narrow Echo Filter</li> <li>• P823 Reform Echo</li> </ul>

Use this feature if the reported material level fluctuates slightly, due to a variable rise in the leading edge of the true echo on the Echo Profile.

Enter the value (in percent of echo height) to ensure the Echo Lock Window intersects the Echo Profile at the sharpest rising portion of the Echo Profile representing the true echo. This value is preset to 90% when P002=1 (Liquid) or 50% when P002=2 (Solid).

## Advanced TVT Adjustment (P830 to P835)

**Note:** The following parameters are for authorized Siemens Milltronics Service personnel or technicians familiar with Siemens Milltronics echo processing techniques.

Advanced TVT control applies to long shots only.

### P830 TVT Type

*Selects the TVT Curve used.*

<b>Values</b>	1	TVT Short Curved
	2	TVT Short Flat
	3	TVT Long Flat
	4	TVT Long Smooth Front
	5	TVT Long Smooth
	6	TVT Slopes
<b>Altered By</b>	• P002 Material	
<b>Related</b>	<ul style="list-style-type: none"> <li>• P805 Echo Confidence</li> <li>• P835 TVT Slope Min</li> </ul>	

Select the TVT type which gives the highest confidence (P805) under all level conditions. Use this parameter with caution, and do not use **TVT Slopes** with the **bF** or **bLF** Algorithm (P820).

## P831 TVT Shaper

*Turns the TVT Shaper ON or OFF.*

<b>Values</b>	0	*	Off
	1		On
<b>Related</b>	• P832 TVT Shaper Adjust		

Turn the TVT Shaper ON before using P832 and afterwards. Turn the TVT Shaper ON and OFF while monitoring the effect to pick up the true echo.

## P832 TVT Shaper Adjust

*Allows manual adjustment of the TVT curve.*





<b>Primary Index</b>	Breakpoint
<b>Values</b>	Range: -50 to 50
	Preset: 0
<b>Related</b>	<ul style="list-style-type: none"> <li>• P810 Scope Displays</li> <li>• P831 TVT Shaper</li> </ul>





Use this feature to bias the shape of the TVT curve to avoid selecting false echoes from fixed objects.

Adjust this parameter while viewing the echo profile with Dolphin Plus. Refer to the Dolphin Plus online help for details. If Dolphin Plus is not available, then an oscilloscope can be used. When using an oscilloscope, the Echo Lock Window display becomes the TVT Curve Pointer. See *P810 Scope Displays* on page 71 for more information.

The TVT curve is divided into 40 breakpoints, accessible by enabling the point number as the breakpoint index field. Each breakpoint is normalized to a value of **0**, as displayed in the parameter value field. By changing the breakpoint value, up or down, the intensity of the bias applied to that breakpoint of the curve is respectively changed. By changing the value of adjacent breakpoints, the effective bias to the shaper can be broadened to suit the desired correction. In the case of multiple false echoes, shaping can be applied along different points of the curve. Shaping should be applied sparingly in order to avoid missing the true echo.

### To change a breakpoint

1. Confirm that P831, TVT shaper, is on.
2. Go to P832.
3. Press MODE  and then press DISPLAY  to access the Breakpoints.
4. Press MODE  to select the Auxiliary function.
5. Press   to scroll the breakpoint index through points 1 to 40, and move the curve pointer right or left respectively.

6. Press ARROWS   to change the bias value of the breakpoint, -50 to 50.
7. Press ENTER .
8. Press TRANSDUCER  to update the scope display with the new TVT.

## P833 TVT Start Min

*Use this feature to adjust the TVT Curve height to ignore false echoes (or pick up true echoes) near the start of the Echo Profile.*

<b>Values</b>	Range: -30 to 225
	Preset: 50
<b>Related</b>	<ul style="list-style-type: none"> <li>• P800 Near Blanking</li> <li>• P834 TVT Start Duration</li> </ul>

Enter the minimum TVT Curve start point (in dB above 1  $\mu$ V rms).

This feature should only be used if increased Near Blanking (P800) would extend farther than desired into the measurement range.

## P834 TVT Start Duration

*Use this feature in conjunction with TVT Start Min (P833) to ignore false echoes (or pick up true echoes) near the start of the Echo Profile.*

<b>Values</b>	Range: 0 to 9999
	Preset: 30
<b>Related</b>	<ul style="list-style-type: none"> <li>• P833 TVT Start Min</li> <li>• P835 TVT Slope Min</li> </ul>

Enter the time (in ms) for the TVT Curve to decrease from the TVT Start Min (P833) point to the TVT Curve baseline.

## P835 TVT Slope Min

*Enter the minimum slope (in dB/s) for the middle of the TVT Curve.*

<b>Values</b>	Range: 0 to 9999
	Preset: 200
<b>Related</b>	<ul style="list-style-type: none"> <li>• P830 TVT Type</li> <li>• P834 TVT Start Duration</li> </ul>

Use this feature to adjust the slope declination, and use it in conjunction with TVT Start Duration (when a long flat TVT Type is selected) to ensure the TVT Curve remains above the false echoes in the middle of the Echo Profile. Alternatively, if TVT Type is set for **TVT Slopes** (P830 = 6), preset is 2000. Use this parameter to adjust the slope declination when TVT type is set to TVT slopes (P830=6).

# Advanced Shot Adjustment (P840 to P852)

**Note:** These parameters are for Siemens Milltronics service personnel only.

## P840 Short Shot Number

*The number of short shots to be fired (and results averaged) per transmit pulse.*

<b>Values</b>	Range: 0 to 100
	Preset: 1
<b>Related</b>	<ul style="list-style-type: none"><li>• P841 Long Shot Number</li><li>• P842 Short Shot Frequency</li><li>• P844 Short Shot Width</li><li>• P850 Short Shot Bias</li><li>• P851 Short Shot Floor</li><li>• P852 Short Shot Range</li></ul>

## P841 Long Shot Number

*Enter the number of long shots to be fired (and results averaged) per transmit pulse.*

<b>Values</b>	Range: 0 to 200
	Preset: 5
<b>Altered By</b>	<ul style="list-style-type: none"><li>• P003 Maximum Process Speed</li></ul>
<b>Related</b>	<ul style="list-style-type: none"><li>• P840 Short Shot Number</li><li>• P843 Long Shot Frequency</li><li>• P845 Long Shot Width</li></ul>

This value is automatically altered by Maximum Process Speed (P003).

## P842 Short Shot Frequency

*Adjust the short shot transmit pulse frequency (in kHz).*

<b>Values</b>	Range: 10 to 60 kHz
<b>Altered By</b>	<ul style="list-style-type: none"><li>• P004 Transducer</li></ul>
<b>Related</b>	<ul style="list-style-type: none"><li>• P840 Short Shot Number</li><li>• P844 Short Shot Width</li><li>• P850 Short Shot Bias</li><li>• P851 Short Shot Floor</li><li>• P852 Short Shot Range</li></ul>

This feature is automatically altered when Transducer (P004) is altered.

## P843 Long Shot Frequency

*Adjust the long shot transmit pulse frequency (in kHz).*

<b>Values</b>	Range: 10 to 60 kHz
<b>Altered By</b>	<ul style="list-style-type: none"> <li>• P004 Transducer</li> </ul>
<b>Related</b>	<ul style="list-style-type: none"> <li>• P841 Long Shot Number</li> <li>• P842 Short Shot Frequency</li> <li>• P844 Short Shot Width</li> <li>• P845 Long Shot Width</li> </ul>

This feature is automatically altered when Transducer (P004) is altered.

## P844 Short Shot Width

*Adjust the width (in ms) of the short shot transmit pulse.*

<b>Values</b>	Range: 0.000 to 5.000
<b>Altered By</b>	<ul style="list-style-type: none"> <li>• P004 Transducer</li> </ul>
<b>Related</b>	<ul style="list-style-type: none"> <li>• P840 Short Shot Number</li> <li>• P842 Short Shot Frequency</li> <li>• P845 Long Shot Width</li> <li>• P850 Short Shot Bias</li> <li>• P851 Short Shot Floor</li> <li>• P852 Short Shot Range</li> </ul>

This feature is automatically altered when Transducer (P004) is altered.

## P845 Long Shot Width

*Adjust the width (in ms) of the long shot transmit pulse.*

<b>Values</b>	Range: 0.000 to 5.000
<b>Altered By</b>	<ul style="list-style-type: none"> <li>• P004 Transducer</li> </ul>
<b>Related</b>	<ul style="list-style-type: none"> <li>• P841 Long Shot Number</li> <li>• P844 Short Shot Width</li> <li>• P843 Long Shot Frequency</li> </ul>

This feature is automatically altered when Transducer (P004) is altered.

## P850 Short Shot Bias

*Use this feature to slant the echo evaluation in favour of the short shot echo when both short and long shots are evaluated (see Shot Mode, P803).*

<b>Values</b>	Range: 0 to 100
	Preset: 20
<b>Related</b>	<ul style="list-style-type: none"> <li>• P803 Shot / Pulse Mode</li> <li>• P840 Short Shot Number</li> <li>• P842 Short Shot Frequency</li> <li>• P844 Short Shot Width</li> <li>• P851 Short Shot Floor</li> <li>• P852 Short Shot Range</li> </ul>

## P851 Short Shot Floor

Enter the minimum echo strength (in dB above 1  $\mu$ V rms) derived from a short shot to be considered for evaluation.

<b>Values</b>	Range: 30 to 100
	Preset: 50
<b>Related</b>	<ul style="list-style-type: none"> <li>• P840 Short Shot Number</li> <li>• P842 Short Shot Frequency</li> <li>• P844 Short Shot Width</li> <li>• P850 Short Shot Bias</li> <li>• P852 Short Shot Range</li> </ul>

## P852 Short Shot Range

Enter the maximum distance in Units (P005) to be measured using short shot echoes.

<b>Values</b>	Range: 0.000 to 9999
<b>Altered By</b>	<ul style="list-style-type: none"> <li>• P004 Transducer</li> </ul>
<b>Related</b>	<ul style="list-style-type: none"> <li>• P840 Short Shot Number</li> <li>• P842 Short Shot Frequency</li> <li>• P844 Short Shot Width</li> <li>• P850 Short Shot Bias</li> <li>• P851 Short Shot Floor</li> </ul>

This feature is automatically altered when Transducer (P004) is altered.

## Test (P900 to P913)

**Note:** These parameters are for Siemens Milltronics service personnel only.

## P900 Software Revision Number

View the EPROM Rev. #.

<b>Values</b>	Range: 00.00 to 99.99 (view only)
---------------	-----------------------------------

## P901 Memory

Press ENTER  to activate the SITRANS LU01 memory test.

<b>Values</b>	Display: view only	
	PASS	(memory test successful)
	F1	RAM
	F2	NOVRAM
	F3	EEPROM
	F4	EPROM

## P902 Watchdog

Press **ENTER**  to put the CPU into an infinite loop to test the watchdog timer.

On successful completion (10 seconds) the RUN mode is entered and the SITRANS LU01 is reset. Programming is kept and the unit responds as if there had been a power failure.

## P903 Display

Press **ENTER**  to activate the display test.

All LCD segments and symbols are temporarily displayed.

## P904 Keypad

Press **ENTER** , then press each keypad key in the following sequence:



As each key is pressed, the associated keypad number is displayed. On successful test completion, **PASS** is displayed. **FAIL** is displayed if a key is pressed out of sequence or the programmer keypad malfunctions.

## P905 Transmit Pulse

Used to monitor the transmit pulse with an oscilloscope connected to the transducer terminals.

<b>Values</b>	Range: 10 to 60 kHz
<b>Altered By</b>	• P004 Transducer

Press **ENTER**  to supply repeated transmit pulses, at the frequency entered, to the transducer and / or view the transducer operating frequency (automatically altered by **P004 Transducer**) for the Point Number displayed.

## P906 Communications

**Note:** Before activating this feature, connect terminal block contacts 27 to 29 and 28 to 30.

Press **ENTER**  to test the SITRANS LU01 communications circuitry.

On successful completion, **PASS** is displayed. Otherwise **FAIL** is displayed. If **FAIL** is displayed, repeat the test (the first test performed sets up the auto polarity function).

## P907 Programmer Interface

Press **ENTER**  to activate the programmer interface (two way infrared communications) test.

On successful test completion, **PASS** is displayed. Otherwise, **FAIL** is displayed.

## P910 Relay

Access this parameter to display the current state of the specified relay.

<b>Values</b>	0 = de-energized
	1 = energized

Press **ENTER**  to alter the relay state (energized / de-energized) or enter the value corresponding to the specific relay state desired.

## P911 mA Output Value

Access this parameter to display the current value of the mA output.

<b>Primary Index</b>	mA output
<b>Values</b>	Range: 0.00 to 25.00
<b>Related</b>	<ul style="list-style-type: none"> <li>• P200 mA Output Range</li> <li>• P201 mA Output Function</li> </ul>

Additionally, this feature may be used to enter a desired value. The mA output immediately assumes the value entered regardless of any restrictions programmed.

## P912 Transducer Temperature

Use this feature to display the temperature in °C (as monitored by the connected transducer).

<b>Values</b>	Range: -50 to 150
---------------	-------------------

**Err** is displayed if the transducer is not equipped with an internal temperature sensor.

## P913 Sensor Temperature

Access this parameter to display the temperature in °C (as monitored by the TS-3).

<b>Values</b>	Range: -50 to 150
---------------	-------------------

**OPEn** is displayed if a TS-3 is not connected.





## Measurement (P920 to P927)

Use these parameters to verify programming, when performing a dynamic material level test over at least 2 empty/fill cycles for each vessel is impractical. The parameters below will display the corresponding Reading in the Parameter Value field, will set the mA output value accordingly, and will set the relay status accordingly.



**Note:** If measurements or simulation are desired, but the LU01 operation has not been verified, disable all associated process control equipment before accessing the following parameters.

To take an ultrasonic measurement, access one of the following parameters, and press

 (repeat five times to overcome Echo Lock, P711).

Alternatively, press ENTER  to simulate a rising and falling material level. During the simulation, the LU01 will operate as though the material level was repeatedly cycling from full to empty to full, and so on, at a rate of 1% of Span (P007) per second. See Lock (P000) to activate control relays during simulation.

The simulation starts at level = 0, unless a specific level was entered.

Press  to switch to the rising (or  for emptying) simulation as required. Holding the key increases (or decreases) the simulated rate of rise (or fall) to 4% of Span per second.

Press  to end simulation.

During a measurement or simulation, the LU01 responds as though in the RUN mode, but the value displayed in the Reading field is affected by the Measurement Parameter selected, and the material level is displayed in the Auxiliary Reading field.

### P920 Reading Measurement

*Corresponds to the final reading after all programming is applied.*

### P921 Material Measurement

*The distance in Units (P005) or % of Span (P007) between Empty (P006) and the monitored surface.*

### P922 Space Measurement

*The distance between the monitored surface and Span (P007).*

### P923 Distance Measurement

*The distance between the monitored surface and the transducer face.*

## P924 Volume Measurement

*The calculated vessel capacity in Max Volume (P051) or % of Max Volume.*

Press ENTER  as required to display in Max. Volume units.

## P927 Distance Percent

*The distance between the surface and the transducer face.*



Use P923 unless the distance information is required in percent (press ENTER ).

## Master Reset (P999)

*This feature resets all parameters to original values.*

<b>Values</b>	Range: 0.000 to 9999
---------------	----------------------

Use this feature prior to initial programming if arbitrary Parameter Values were used during a **bench test**, or after upgrading the software. Following a Master Reset, complete reprogramming is required.

To perform a Master Reset, access P999 and press CLEAR  . **C.ALL** displays until the reset is complete.

**CAUTION: Be careful when using this feature. All data will be reset. For convenience, be sure to record the values you want to re-enter.**

## Transmit Pulse

The SITRANS LU01 transmit pulse consists of one or more electrical shot pulses, which are supplied to the scanning relay. The scanning relay is activated as required, to supply the transmit pulse to the Transducer(s) connected to the SITRANS LU01 terminals.

The transducer fires an acoustic shot for each electrical pulse supplied. After each shot is fired, sufficient time is provided for *echo* (shot reflection) reception, before the next (if applicable) shot is fired. After all shots of the transmit pulse are fired, the resultant echoes are processed.

The transmit pulse shot number, frequency, duration, delay, and associated measurement range are defined by parameters P803 and P840 to P852.

## Echo Processing

Echo processing consists of echo enhancement, true echo selection, and selected echo verification.

Echo Enhancement is achieved by filtering (P821 and P822) and reforming (P823) the echo profile (digitized signal representing the echo signal received).

True echo selection is achieved by establishing the criteria which a portion of the echo profile must meet to be considered the true echo (echo reflected by the intended target).

Insignificant portions of the echo profile outside of the measurement range (Span P007 + Range Extension P801), below the TVT Curve (P830 to P835), and less than the Confidence Threshold (P804) and Short Shot Floor (P851) are automatically disregarded.

The remaining portions of the Echo Profile are evaluated using the Algorithm(s) (P820) and Short Shot Bias (P850) programmed. When a combination of Algorithms are used, the portion of the Echo Profile providing the best averaged Echo Confidence (P805), is selected as the true echo.

True echo verification is automatic. the position (relation in time after transmit) of the new echo is compared to that of the previously accepted echo. When the new echo is within the Echo Lock Window (P713), it is accepted and displays, outputs, and relays are updated as restricted by the Fuzz Filter (P710) and Rate Parameters (P700 to P703). If the new echo is outside of the Echo Lock Window, the new echo is not accepted until Echo Lock (P711) requirements are satisfied.

# Echo Processing Displays (Scope Displays, P810)

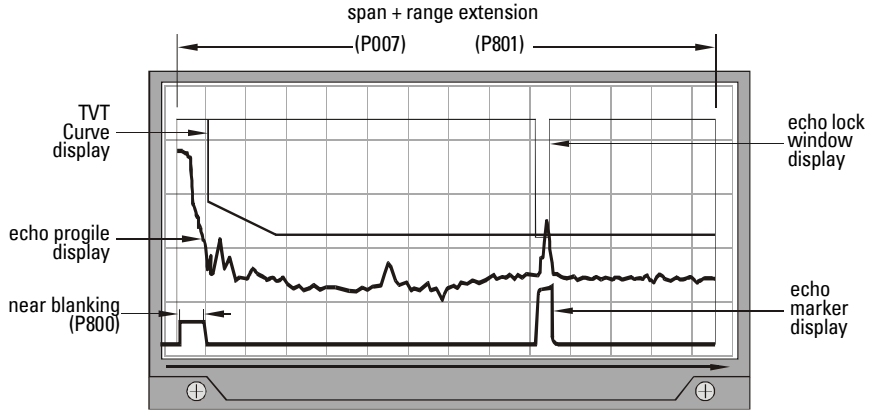

## Dolphin Plus Display

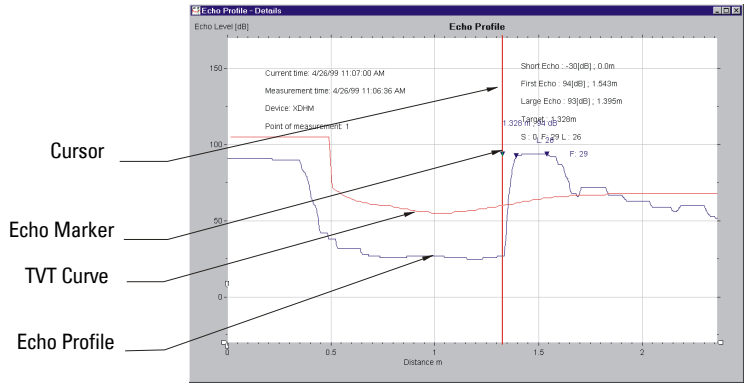

## Distance Calculation

To calculate the transducer to material level (object) distance, the *transmission medium* (atmosphere) sound velocity (P653) is multiplied by the acoustic transmission to reception time period. The result (round trip distance) is divided by 2.

$$\text{Distance} = \frac{\text{Sound Velocity} \times \text{Time}}{2}$$

The Reading Value displayed is the result of performing any additional modification to the calculated distance (Operation P001, Units P005, Volume Conversion, P050 to P054, Reading Value, P060 to P063.)

## Sound Velocity

The sound velocity of the transmission medium is affected by the type, temperature, and vapour pressure of the gas or vapour present. As preset, the SITRANS LU01 assumes the vessel atmosphere is air at 20°C (68°F). Unless altered, the sound velocity used for the distance calculation is 344.1 m/s (1129 ft/s).

Variable air temperature is automatically compensated when a Siemens Milltronics ultrasonic/temperature transducer is used. If the transducer(s) are exposed to direct sunlight, use a sun shield or a separate TS-3 temperature sensor.

Also, if the temperature varies between the transducer face and the object monitored, a TS-3 temperature sensor, mounted near the material surface (solids) or submerged (liquids), should be used in combination with the ultrasonic/temperature transducer. Then when Temp Source, (P660) is set for **both**, the transducer and TS-3 temperature measurements are averaged.

Atmosphere composition other than air can pose a challenge for ultrasonic level measurement. However, excellent results may be obtained if the atmosphere is homogeneous, at a fixed temperature, and consistent vapour pressure, by performing a Sound Velocity Calibration (P651).

The SITRANS LU01 automatic temperature compensation is based on the sound velocity/temperature characteristics of **air** and may not be suitable for the atmosphere present. If the atmosphere temperature is variable, frequent Sound Velocity Calibrations may be required to maintain optimum measurement accuracy.

Sound Velocity calibration frequency may be determined with experience. If the sound velocity in two vessels is always similar, future calibrations may be performed on one of the vessels and the resultant Velocity (P653) entered directly for the other vessel.

If the sound velocity of a vessel atmosphere is found to be repeatable at specific temperatures, a chart or curve may be developed. Then, rather than performing a Sound Velocity Calibration each time the vessel temperature changes significantly, the anticipated Velocity (P653) may be entered directly.

## Volume Calculation

The SITRANS LU01 provides a variety of volume calculation features (P050 to P055).

If the vessel to be monitored does not match any of the 8 preset Tank Shape calculations, a Universal Volume calculation may be used. Use the level/volume graph or chart provided by the vessel fabricator (or create one based on the vessel dimensions).

From this graph, determine which Universal Volume calculation will provide the best results, and select the level vs volume breakpoints to be entered (32 max.). Generally, the more breakpoints entered, the greater the volume calculation accuracy.

### Universal, Linear (P050 = 9)

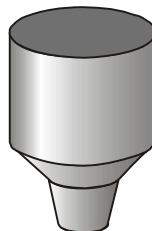
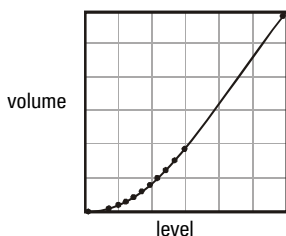

This volume calculation creates a piece-wise linear approximation of the level/volume curve. This option provides best results if the curve has sharp angles joining relatively linear sections.

Enter a Level Breakpoint at each point where the level/volume curve bends sharply (2 minimum).

For combination curves (mostly linear but include 1 or more arcs), ensure numerous breakpoints are entered along the arc, for best volume calculation accuracy.

## Universal, Curved (P050 = 10)

This volume calculation creates a cubic spline approximation of the level/volume curve. This option provides best results if the curve is non-linear, and there are no sharp angles.

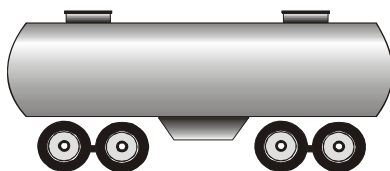
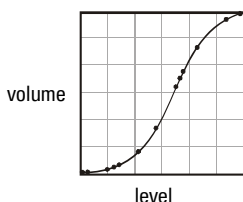

Select at least enough breakpoints from the curve to satisfy the following:

- 2 breakpoints very near the minimum level
- 1 breakpoint at the tangent points of each arc
- 1 breakpoint at each arc apex
- 2 breakpoints very near the maximum level

For combination curves, ensure at least 2 breakpoints are entered immediately before and after any sharp angle (as well as 1 breakpoint exactly at the angle) on the curve.

## Maximum Process Speed

The SITRANS LU01 Maximum Process Speed (P003) to material level changes is designed to exceed the most demanding installation requirements.

If any of these parameters are independently altered, a Max. Process speed parameter alteration automatically changes the independently altered value.

**Note:** Slower Max. Process Speed provides greater measurement reliability. Faster independently set Max Fill/Empty Rates may be impeded by Echo Lock, Scan Delay and Shot Delay values.

The Process Speed setting automatically adjusts various parameters affecting the SITRANS LU01 response to material level changes as in the table that follows.

#	Parameter Name (Units)	Values Dependent on Measurement Response (P003) Value				
		1(slow)	2(medium)	3(fast)	4(surge)	(5imm.)
P070	Failsafe Timer (min)	100	10	1	0.1	0
P700	Max Fill Rate (m/min)	0.1	1	10	100	1000
P701	Max Empty Rate (m/min)	0.1	1	10	100	1000
P702	Filling Indicator (m/min)	0.01	0.1	1	10	100
P703	Emptying Indicator (m/min)	0.01	0.1	1	10	100
P704	Rate Filter (option)	4	3	2	2	2
P710	Fuzz Filter (% of P007)	100	50	10	1	0
P711	Echo Lock (option)	1 or 2 (dependent on Material (P002))				
P713	Echo Lock Window	(dependent on P701/P702 and time since last valid measurement)				
P728	Shot Delay (s)	0.5	0.5	0.5	0.2	0.1
P803	Shot/Pulse Mode (option)	2	2	2	1	1
P841	Long Shot Number (qty)	10	5	2	1	1

\* Scan Delay (P727) is globally set for all Point Numbers to the value associated with the fastest Measurement Response (P003) selected for Point Number 1 or 2.

## Application Examples

The following examples describe the use of SITRANS LU01 programmable features, to meet the needs of specific process measurement requirements.

It is highly unlikely that your specific installation will match one of these examples exactly.

However, by reviewing the example (or combination of examples) that matches your installation best, the relationship between SITRANS LU01 features and process measurement requirements may be more easily recognized.

Example #	Description
1	Level (or Material Volume) Measurement for a single vessel.
2	Space (or Remaining Vessel Capacity) Measurement for a single vessel.

# Example 1 - Level Measurement

## Material Level

This is the most common application of the SITRANS LU01 level monitor.

For this example we'll assume the following:

- one 30 m high cement silo is to be monitored.
- the maximum vessel filling rate is 0.08 m per minute.
- alarm indicators are required when the cement level exceeds 25 m or falls below 10 m.
- filling equipment is to be automatically deactivated at 27 m.
- in the event of a measurement difficulty, failsafe operation is to be activated in 2 minutes.
- if the difficulty doesn't subside, the filling process is to be stopped before a spill occurs.
- an XLT-30 transducer is mounted with its face flush with the top of the vessel.
- a TS-3 temperature sensor is connected to the Temp Sensor 1 terminals.

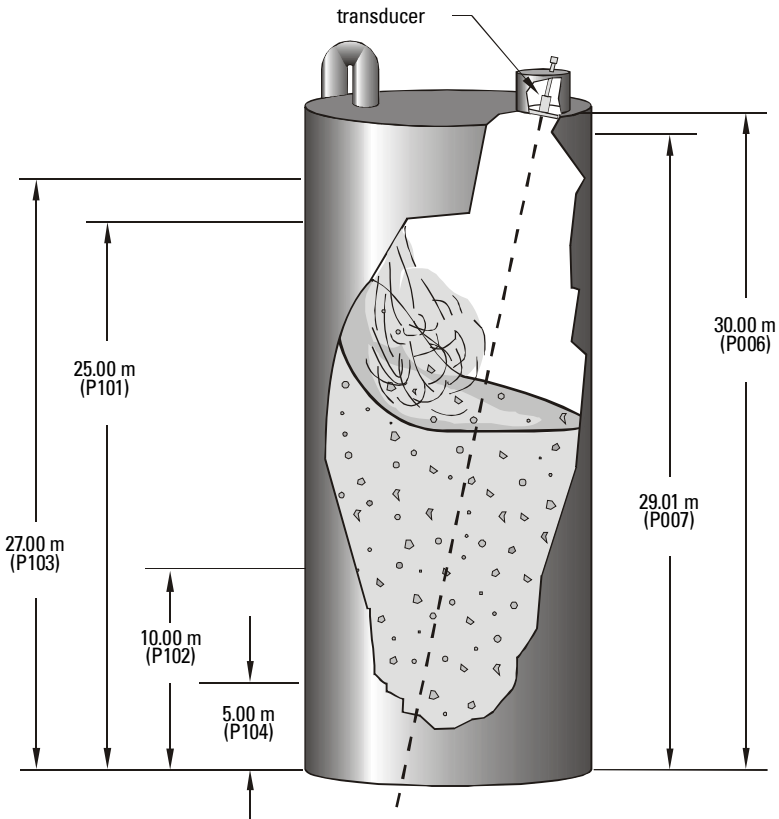



## Parameter Settings for Point # 1

Number	Description	Instructions
P001	Operation	Enter "1" for <i>level</i> .
P002	Material	Enter "2" for <i>solid</i> .
P003	Measurement Response	Enter "1" for <i>slow</i> (0.1 m/min).
P004	Transducer	Enter "107" for <i>XL7-30</i> .
P005	Units	No entry required, (preset for <i>metres</i> ).
P006	Empty	Enter "30" for transducer face to Empty equals <i>30.00 metres</i> .
P007	Span	No entry required, (preset to <i>29.01 metres</i> ).
P070	Failsafe Timer	Enter "2" for failsafe activation after <i>2 minutes</i> without a valid echo.
P071	Failsafe Material Level	Enter "HI" for <i>advance to Span on "LOE"</i> .
P072	Failsafe Advance	No entry required. (preset to <i>restricted</i> ).
P100	Relay Set Up	Enter "4" for <i>High, Low, High High, and Low Low</i> alarm relays.
P101	<i>High Alarm</i>	Enter "25" for <i>High Alarm at 25.00 m</i> .
P102	<i>Low Alarm</i>	Enter "10" for <i>Low Alarm at 10.00 m</i> .
P103	<i>High High Alarm</i>	Enter "27" for <i>High High Alarm at 27.00 m</i> .
P104	<i>Low Low Alarm</i>	Enter "5" for <i>Low Low Alarm at 5.000 m</i> .

With process control equipment disabled, enter the RUN mode to monitor system performance and alarm programming. Otherwise, perform a Reading Measurement simulation (P920).

*When satisfied with system performance and programming:*

- connect a high alarm indicator to Relay #1 (see P100 = 4).
- connect a low alarm indicator to Relay #2.
- connect a high high alarm indicator and filling equipment stop/start control to Relay #3.
- connect a low low alarm indicator to Relay # 4.

(Note that relays are de-energized in **power off** and **alarm** conditions).

For cement applications (or any very dusty dry solids), measurement difficulties during vessel filling are common. For this example (assume the maximum filling rate), failsafe operates as follows:

e.g.

09:15 am	Echo lost at 6.00 m, low alarm is still on, failsafe countdown begins		
09:17 am	Failsafe activated,	actual level = 6.16 m,	reported level = 6.00 m.
09:57 am	Low alarm off,	actual level = 9.36 m,	reported level = 10.00 m.
12:27 am	High alarm on,	actual level = 21.36 m,	reported level = 25.00 m.
12:47 am	Infeed stopped,	actual level = 22.96 m,	reported level = 27.00 m.

When the dust settles (and the echo is regained) the reported level advances toward the actual level. When the reported level reaches 25.55 m (5% of Span less than the high high alarm trip point), the high high alarm goes off, restarting the infeed and filling the vessel to 27.00 m.

## Material Volume

To perform a volume conversion for the preceding example, we'll assume:

- the vessel is cylindrically shaped with a flat bottom.
- the vessel volume for Empty to 29.01 m (Span) is 1457 m<sup>3</sup>.

### Volume Parameter Settings

Number	Description	Instructions
P050	Tank Shape	Enter "1" for <i>vertical cylinder with flat bottom</i> .
P051	Max Volume	Enter "1457" for <i>1457 m<sup>3</sup></i> .

Now in the RUN mode the Reading represents material volume in m<sup>3</sup>.

## Example 2 - Space Measurement

This mode of operation is commonly used when remaining vessel capacity is of more importance to the installation than the actual material level.

### Space

For this example we'll assume the following:

- the vessel is a 3 ft diameter by 15 ft long cylinder (including the parabolic ends of 1.5 ft each).
- the maximum vessel filling rate is 1 ft per minute (slower at mid level).
- a mA output scaled from 4 mA at Full to 20 mA at Empty is required for PLC operation.
- in the event of a measurement difficulty, failsafe operation is to be activated in 6 seconds.
- if the difficulty doesn't subside, the mA output must immediately assume 22.00 mA.
- an XCT-8 transducer is mounted in a standpipe so that the face is 18 in. above the vessel top.
- a TS-3 temperature sensor is mounted in the vessel to monitor liquid temperature.

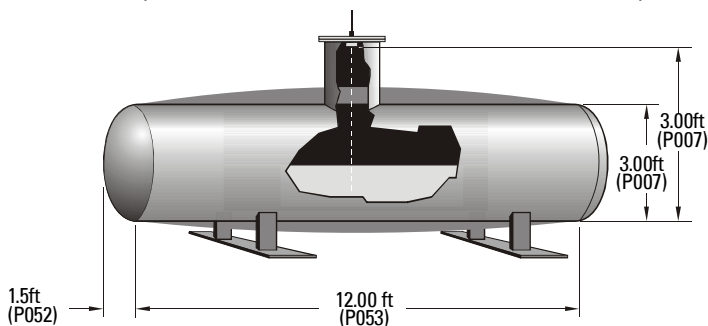

### Parameter Settings for Point # 1

Number	Description	Instructions
P001	Operation	Enter "2" for <i>space</i> .
P002	Material	No entry required (preset for <i>liquid</i> ).
P003	Measurement Response	Enter "4" for <i>surge</i> (100 m/min, Failsafe Timer = 0.1 minutes).
P004	Transducer	Enter "101" for <i>XCT-8</i> .
P005	Units	Enter "4" for <i>feet</i> .
P006	Empty	Enter "4.5" for <i>4.50 ft</i> (3 feet diameter plus 1.5 ft in standpipe).
P007	Span	Enter "3" for <i>3 ft</i> (vessel diameter).
P070	Failsafe Timer	No entry required, (preset by P003).

### Parameter Settings for Ma Output #1

Number	Description	Instructions
P200	mA Range	No entry required. (preset for <i>20 mA = low level</i> , P001 = 2.)
P213	mA Max Limit	Enter "22" for <i>22.00 mA</i> .
P219	mA Failsafe	Enter "20.2" for <i>20.20 mA</i> .

### Parameter Setting for Temperature Averaging

Number	Description	Instructions
P660	Temp Source	Enter "5" for average XCT-8 and TS-3 temperatures.

With process control equipment disabled, enter the RUN mode to monitor system performance and alarm programming. (A Reading Measurement simulation (P920) may be performed to verify mA output programming).

When satisfied with system performance and programming, connect mA output 1 to the Programmable Logic Controller (PLC).

Note that on **power off** the mA output drops to 0.00 mA. During a power interruption, the **last known** mA output value is maintained in memory for 1 hour minimum. If power is interrupted beyond 1 hour, on power resumption, the mA output immediately assumes the **new value**.

## Remaining Vessel Capacity

To perform a volume conversion for the preceding example, complete the following programming.

### Volume Parameter Settings

Number	Description	Instructions
P050	Tank Shape	Enter "7" for <i>horizontal cylinder with parabolic ends</i> .
P051	Max Volume	Enter "117" for <i>117 cubic feet</i> (Use vessel fabricators value).
P052	Tank Dimension A	Enter "1.5" for <i>1.5 ft</i> (the horizontal length of one parabolic end).
P053	Tank Dimension L	Enter "12" for <i>12 ft</i> (the horizontal length, excluding parabolic ends).

\* This is the only tank shape where the Span (P007) value must exactly equal the vessel height.

Now in the RUN mode, the Reading Value and mA output will represent remaining vessel capacity in cubic feet. If the mA output is still to be scaled to **space** (distance from material to Full in feet) set the mA Function (P201) to **2**.

## Application Assistance

The preceding examples describe only a few ways in which the SITRANS LU01 can be applied to process measurement requirements.

The SITRANS LU01 can be used to monitor almost any process (within the temperature, measurement range, and chemical immunity capabilities of the system) where a distance measurement or determination of presence vs. lack of presence of an object is desired.

By thoroughly reviewing the Parameters sections, you may identify some interesting ways of using the SITRANS LU01 to monitor specific processes.

Siemens Milltronics has many years experience applying ultrasonic level measurement to a variety of processes in the mining, aggregate, lumber, grain, chemical, pulp and paper, water, and waste water industries.

If you encounter a difficulty applying the SITRANS LU01 to a process measurement requirement, please contact Siemens Milltronics or your local distributor.

## Communication Support

With the addition of a Siemens Milltronics Smartlinx<sup>®</sup> protocol specific plug-in communications module, the SITRANS LU01 is compatible with popular industrial control system standards. Supported protocol include PROFIBUS DP, Allen-Bradley<sup>®</sup> Remote I/O, Modbus<sup>®</sup> RTU, and DeviceNet<sup>™</sup>.

Alternatively, the SITRANS LU01 provides digital communication to a peripheral device, such as a computer or PLC, in one of three modes via the communication port, terminals

26 through 32. The mode of communication is established by the configuration of the connection made at the SITRANS LU01, either RS-232, RS-485 or bipolar current loop.

The SITRANS LU01 uses *simplex convention* communication protocol. Data messages are continuously transmitted at regular intervals (no poll is required) at 4800 baud. All data is transmitted in structured messages of ASCII characters consisting of 8 data bits, no parity, and 1 stop bit.

If Peripheral Communications (P740) is set for "formatted" messages, a comma is inserted between each message field (except immediately preceding the "End of Message" characters).

## MT-00 Measurement Message

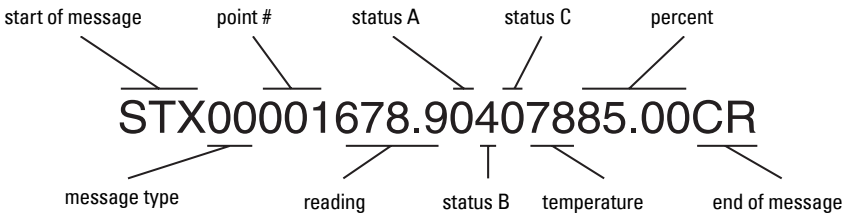

Field Name	Definition
Start Of Message	STX (\$02)
Message Type	2 characters, 00 (indicates the following data pertains to a scan point measurement)
Point #	3 characters, 001 to 003 (e.g. the message pertains to Point Number 1)
Reading	5 characters, 0.000 to 9999. (e.g. reading = 678.9, DDDD. = no data, EEEE. = overflow)

### Status A

1 character, \$0 to \$F (convert to binary, e.g. temp, echo, and cable OK, not priority)

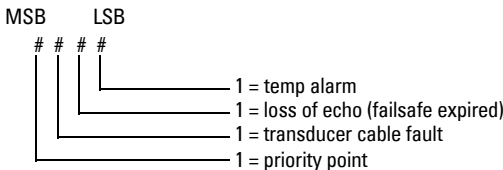

## Status B

1 character, \$0 to \$F (convert to binary, e.g. scan point is in high alarm)

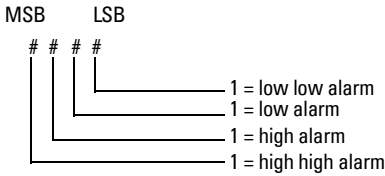

## Status C

1 character, \$0 to \$F (convert to binary, e.g. scan point is not in rate or band alarm)

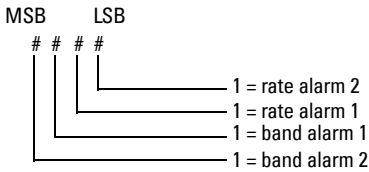

Field Name	Definition
Temp	2 characters, \$32 to \$FA (convert to decimal and subtract 100, e.g. temperature = 20 °C)
Percent	5 characters, 00.00 to 9999. (e.g. current level = 85.00% of span, EEEE. = field overflow)
End Of Message	CR (\$0D)

## MT-01 Hold Message

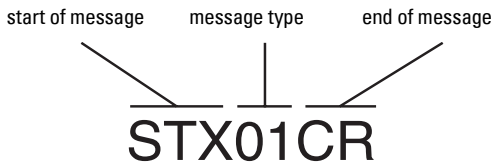

Field Name	Definition
Start Of Message	STX (\$02)
Message Type	2 characters, 01 (indicates the SITRANS LU01 was removed from the RUN mode)
End Of Message	CR (\$0D)

# MT-03 Point Not Scanned

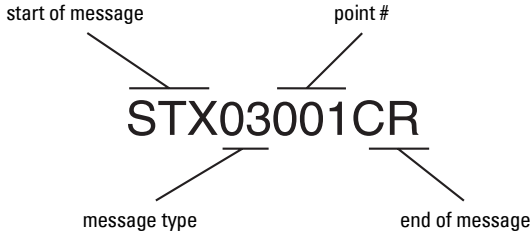

Field Name	Definition
Start Of Message	STX (\$02)
Message Type	2 characters, 03 (indicates the Point Number is not in service)
Point #	3 characters, 001 to 003 (e.g. Point Number 1)
End Of Message	CR (\$0D)

Technical Reference

# Maintenance

---

The SITRANS LU01 should require no maintenance or cleaning, though good housekeeping practices in and around the area of the enclosure are recommended.

Wipe out the area of the enclosure lid docking bay recess with a clean dry cloth (if necessary) before installing the programmer.

Transducer inspection, to verify the effectiveness of the self cleaning design, is recommended. If material build up on the transducer face is observed, to maintain maximum system performance, a schedule of regular cleaning should be adopted.

## Unit Repair and Excluded Liability

All changes and repairs must be done by qualified personnel and applicable safety regulations must be followed. Please note the following:

- The user is responsible for all changes and repairs made to the device.
- All new components must be provided by Siemens Milltronics Process Instruments Inc.
- Restrict repair to faulty components only
- Do not re-use faulty components.



# Troubleshooting Guide

Symptom	Cause	Action
Display blank, Transmit Neon not flashing, transducer not pulsing	No power	Check Power supply, wiring, and voltage switch.
No response to programmer.	Obstructed infrared interface, or defective programmer	Clean enclosure "docking bay" and programmer magnet slot.
Displays "Short" and "tb:(#)."	Short circuited transducer cable or defective transducer.	Repair or replace as necessary.
Displays "Open" and "tb:(#)."	Transducer not connected	Connect transducer, or remove Point # from service (P001=0).
	Open circuited transducer cable, or defective transducer.	Repair or replace as necessary
Displays "Error" and "tb:(#)."	Transducer connected wrong	Reverse BLK and WHT wires
	Wrong transducer (P004)	Enter correct value
Displays "LOE"	Weak or non-existent echo.	Relocate and/or re-aim transducer at material level or object. Proceed to Measurement Difficulties.
Displays "EEEE"	Reading too high.	Select larger Units (P005), or lower Convert Reading (P061).
Reading fluctuates while material level is still, (or vice versa).	Incorrect measurement stabilization.	Alter measurement Response (P003) accordingly. See Technical Reference / Measurement Response.
Reading is fixed, regardless of the actual material level.	Transducer beam obstructed, standpipe too narrow, or transducer mounting resonant.	Relocate and/or re-aim transducer at material level or object Proceed to Measurement Difficulties.
Material level reported is always "off" by the same amount.	Incorrect Empty (zero) reference.	See Empty (P006), Reading Offset (P063), Offset Calibration (P650), and Offset Correction (P652).
Measurement accuracy improves as level nears transducer.	Incorrect Sound Velocity used for distance calculation.	use an ultrasonic/temperature transducer or a TS-3 temperature sensor. See Technical Reference Sound Velocity.
Reading is erratic, with little or no relation to material level.	True echo too weak or wrong echo being processed.	Relocate and/or re-aim transducer at material level or object Proceed to Measurement Difficulties.

# Measurement Difficulties

If a measurement difficulty occurs for greater than the Failsafe Timer (P070) setting, **LOE** is flashed alternately with the Reading display. Under certain conditions, a measurement difficulty may cause the SITRANS LU01 to lock on to a false echo and report a fixed or wrong reading.

## Flashing LOE Display

If **LOE** is displayed, ensure that the:

1. Material (object) surface monitored is within the maximum range of the transducer.
2. Transducer (P004) value matches the transducer used.
3. Transducer is located and aimed properly.

(See the Transducer manual for maximum range, mounting and rough aiming instructions.)

For optimum performance, adjust the transducer aiming while monitoring the Echo Confidence (P805) for various material levels over the measurement range. When complete, set the transducer aiming at the best angle for all levels.

*To display Echo Confidence in the RUN mode:*

Press  and hold for 4 seconds (Failsafe Time Left changes to the Short : Long Confidence display).

To display Echo Confidence in PROGRAM mode, access the Echo Confidence (P805) parameter.

*To update the value displayed after each aiming adjustment...*

Press  (5 times or more to verify stability)

If the condition persists (despite optimum aiming), optimize transducer performance. (See Enhancement Parameters Short Shot Frequency, P840 and Long Shot Frequency, P841).

Increase the Failsafe Timer (P070) value, if failsafe operation will not be compromised by the larger value.

If **LOE** is displayed only when a sloped bottom vessel is near Empty, the echo is probably being reflected away from the transducer. Install an empty **target plate** in the bottom of the vessel. When exposed (not covered by material), the target plate provides the reflective surface representative of an empty vessel.

Install a longer range transducer, enter the new Empty (P006) distance, and (if necessary) optimize aiming and frequency again.

If a longer range transducer is not available, connect an oscilloscope to the SITRANS LU01, (see Enhancement Parameters Scope Displays, P810).

If a discernible echo is observed (representative of the material/object surface), reduce the Confidence Threshold (P804) while taking new measurements (in the RUN or PROGRAM mode).

Sometimes, material simply cannot be detected during vessel filling. In these cases, set up failsafe operation so the SITRANS LU01 anticipates the rate of material level increase and adjusts the reported Reading accordingly. This operation is reliable, as long as when the dust (or foam) settles a valid echo can be received. See Technical Reference Application Examples \ Example 1 - Level Measurement.

## Fixed Reading

If the Reading is a fixed value, regardless of the transducer to material (object) surface distance, ensure the:

1. Transducer sound beam is free from obstruction.
2. Material (object) surface monitored is not within the Transducers' nearest measurable distance.
3. Transducer is not in contact with any metal object.
4. Material agitator (if used) is **on** while the SITRANS LU01 is operating.

If the fixed Reading represents a distance more than 3 metres (9 feet) from the transducer face, the SITRANS LU01 is probably detecting some vessel interior obstruction. Aim away from (or remove) the obstruction.

If the obstruction cannot be removed or avoided, the SITRANS LU01 TVT (Time Varying Threshold) Curve must be modified to reduce the Echo Confidence derived from the sound reflected by the obstruction. (See Enhancement Parameters Scope Displays, P810 and TVT Shaper, P832).

If the fixed Reading represents a minimal distance from the transducer face, the condition may be caused by a sound beam obstruction (check for this first), but could also be due to other factors.

If the material (object) surface is within the Transducers' *nearest distance* (see Installation/Transducer Mounting on page 10), mount the transducer higher above (farther away from) the nearest object to be monitored.

If the transducer is mounted on a standpipe, grind smooth any burrs or welds on the inside or *open end* (the end that opens into the vessel). If the problem persists, install a larger diameter or shorter length standpipe, or *flare* (increase the diameter of) or cut the open end of the standpipe at a 45° angle.

For ST-series transducers only, ensure the non-metallic mounting hardware (supplied) is used. Often, loosening over tightened mounting hardware will mechanically isolate the transducer from a resonant metallic surface.

Regardless of the mounting type, if difficulties persist, optimize the Transducer operating frequencies (see Enhancement Parameters Short Shot Frequency (P840) and Long Shot Frequency (P841)).

If the preceding remedies have not produced satisfactory results, the false echo has to be ignored. Extend Near Blanking (P800) to a distance (from the transducer face) to just beyond the distance represented by the Reading. This also increases the nearest distance the material level/object may come within the transducer face and still be detected.

If increasing Near Blanking is unacceptable (the transducer cannot be mounted higher) see Auxiliary Transducer (P725). Otherwise, the TVT Curve must be raised in the area of the false echo.

Connect an oscilloscope to the SITRANS LU01, ( see Enhancement Parameters Scope Displays, P810). Adjust the TVT Start Min (P833), TVT Start Duration (P834), and TVT Slope Min (P835) slightly.

Continue making minor TVT Curve adjustments and taking new measurements while observing the Echo Marker position until the Echo Lock Window repeatedly locks onto the true echo. Verify the false echo is still ignored, regardless of the vessel material level, or empty/fill activity.

## Wrong Reading

If the Reading is erratic, or jumps to some incorrect value periodically, ensure the:

1. Material (object) surface monitored, is not beyond the transducers maximum range.
2. Material is not falling in the transducer sound beam.
3. Material (P002) value matches the material monitored.
4. Measurement Response (P003) is not set too fast.
5. Transducer (P004) type entered matches the transducer used.

If the periodic incorrect value is always the same, see Fixed Reading. If the incorrect value seems to be random, verify the material surface to transducer distance is less than the Empty value entered plus 20%. If the material/object monitored is outside this distance, increase Range Extension (P801) as required.

If the material monitored is a liquid, check for splashing in the vessel. Decrease Measurement Response (P003) as required to stabilize the Reading, or install a stilling well (contact Milltronics or your local distributor).

Access the Noise (P807) parameter. If the peak value jumps wildly, verify the transducer cable shields are connected to the SITRANS LU01 shield terminals and not to ground elsewhere.

If the SITRANS LU01 is mounted in close proximity to (or transducer cables run near those of) another ultrasonic level monitor, see Level System Sync (P726).

Temporarily disable nearby SCR control drives, high voltage or current contactors. If the condition disappears, move the SITRANS LU01 to another location.

Set Echo Lock (P711) to "max verification" (response to material level changes may be slowed somewhat).

Increase the Confidence Threshold (small amounts at a time) while observing the results. If performance is not improved return the Confidence Threshold to the preset value.

Connect an oscilloscope to the SITRANS LU01, (see Enhancement Parameters Scope Displays, P810). While monitoring the Echo Marker, select the Algorithm (P820) best suited to the material/conditions.

If the **Area** algorithm is used and narrow noise spikes are evident on the (long shot) Echo Profile, turn the Spike Filter (P821) on and/or widen the Narrow Echo Filter (P822). Also, if the true echo has jagged peaks, use Reform Echo (P823).

If multiple echoes appear on the Echo Profile, typical of a flat material profile (especially if the vessel top is domed), use the first Algorithm.

If the Echo Profile repeatedly switches from short to long, adjust the Short Shot Range (P852) to stabilize the shot mode used for the echo evaluation. Also, adjust the Short Shot Bias to increase (or decrease) the amount of preference given to short shot echoes over long shot echoes.

Should a stable measurement still not be attainable, contact Siemens Milltronics or your local distributor.

# Programming Charts

#	Parameter Name	Altered Values for Indices/Point Numbers		
		1	2	3
<b>Security</b>				
P000	Lock (G)			
<b>Quickstart</b>				
P001	Operation			
P002	Material			
P003	Max. Process Speed			
P004	Transducer			
P005	Units (G)			
P006	Empty			
P007	Span			
<b>Volume</b>				
P050	Tank Shape			
P051	Max Volume			
P052	Tank Dimension A			
P053	Tank Dimension L			
P054	Level Breakpoints		record values on a seperate sheet.	
P055	Volume Breakpoints		record values on a seperate sheet.	
<b>Reading Value</b>				
P060	Decimal Position			
P061	Convert Reading			
P062	Offset Reading			
<b>Failsafe</b>				
P070	Failsafe Timer			
P071	Failsafe material Level			
P072	Failsafe Level Advance			
<b>Relays</b>				
P100	Relay Set Up (G)			
P101	Hi Alarm			
P102	Lo Alarm			
P103	Hi Hi Alarm			
P104	Lo Lo Alarm			
P111	Relay Function			
P112	Relay A Setpoint			
P113	Relay B Setpoint			

Parameter		Altered Values for Indices/Point Numbers		
#	Name	1	2	3
P116	Bound Alarm Deadband			
P129	Relay Failsafe			
<b>mA Outputs</b>				
P200	mA Range			
P201	mA Function			
P202	mA Allocation			
P203	mA Value / Transducer (V)			
P210	0/4 mA Setpoint			
P211	20 mA Setpoint			
P212	mA Min Limit			
P213	mA Max limit			
P214	4 mA Trim			
P215	20 mA Trim			
P219	mA Failsafe			
<b>Data Logging</b>				
P300	Temp, Transducer max (V)			
P302	Temperature, Sensor max (V)			
P330	Profile Record			
P331	Auto Record Enable (G)			
P332	Auto Record Transducer (G)			
P333	Auto Record Interval (G)			
P334	Auto Record A Setpoint			
P335	Auto Record B Setpoint			
P336	Auto Record Filling/Emptying			
P337	Auto Record LOE Time			
<b>Installation Records</b>				
P340	Date of Manufacture			
P341	Run Time			
P342	Start Ups			
<b>Range Calibration</b>				
P650	Offset Calibration			
P651	Sound Velocity Calibration			
P652	Offset Correction			
P653	Velocity			
P654	Velocity @ 20° C			
<b>Temperature Compensation</b>				
P660	Temp Source			

<b>Parameter</b>		<b>Altered Values for Indices/Point Numbers</b>		
<b>#</b>	<b>Name</b>	<b>1</b>	<b>2</b>	<b>3</b>
P661	Temp fixed			
P664	Temperature (V)			
<b>Rate</b>				
P700	Max Fill Rate			
P701	Max Empty Rate			
P702	Filling Indicator			
P703	Emptying Indicator			
P704	Rate Filler			
P705	Rate Update Time			
P706	Rate Update Distance			
P707	Rate Value (V)			
<b>Measurement Verification</b>				
P710	Fuzz Filter			
P711	Echo lock			
P712	Reserved			
P713	Echo lock Window			
<b>Scanning</b>				
P726	Level System Sync (G)			
P728	Shot Delay (G)			
P729	Scan Time			
<b>Display</b>				
P730	Auxiliary Reading (G)			
P731	Auxiliary Reading Key (G)			
P732	Display Delay (G)			
P733	Scroll Access (G)			
<b>Peripheral Communication Support</b>				
P740	Peripheral Communications (G)			
P748	RS485 Termination			
P749	Serial Bus Type			
<b>SmartLinX</b>				
P772	Baud Rate			
P790	Hardware Error			
P791	Bus Error			
P792	Bus Error Count			
<b>Echo Processing</b>				
P800	Near Blanking			
P801	Range Extension			



<b>Parameter</b>		<b>Altered Values for Indices/Point Numbers</b>		
<b>#</b>	<b>Name</b>	<b>1</b>	<b>2</b>	<b>3</b>
P802	Submergence Transducer			
P803	Shot/Pulse Mode			
P804	Confidence Threshold			
P805	Echo Confidence (V)			
P806	Echo Strength (V)			
P807	Noise (V)			
<b>Advanced Echo Processing</b>				
P810	Scope Displays			
P816	Echo Time			
P817	Profile Pointer Time			
P818	Profile Pointer Distance			
P819	Profile Pointer Amplitude			
P820	Algorithm			
P821	Spike Filter			
P822	Narrow Echo Filter			
P823	Reform Echo			
P824	(reserved)			
P825	Echo Marker Trigger			
P830	TVT Type			
P831	TVT Shaper			
P832	TVT Shaper Adjust			
P833	TVT Start Min			
P834	TVT Start Slope			
P835	TVT Slope Min			
P840	Short Shot Number			
P841	Long Shot Number			
P842	Short Shot Frequency			
P843	Long Shot Frequency			
P844	Short Shot Width			
P845	Long Shot Width			
P850	Short Shot Bias			
P851	Short Shot Floor			
P852	Short Shot Range			



[www.siemens.com/processautomation](http://www.siemens.com/processautomation)

Siemens Milltronics Process Instruments Inc.  
1954 Technology Drive, P.O. Box 4225  
Peterborough, ON, Canada K9J 7B1  
Tel: (705) 745-2431 Fax: (705) 741-0466  
Email: [techpubs.smpi@siemens.com](mailto:techpubs.smpi@siemens.com)

© Siemens Milltronics Process Instruments Inc. 2008  
Subject to change without prior notice



7 M L 1 9 9 8 5 B E 0 2  
Printed in Canada

**Rev. 2.4**