

Radar Transmitters

SITRANS LR560 (mA/HART)

Quick Start Manual · 03/2013



SITRANS

SIEMENS

SITRANS LR560 (HART) Quick Start Manual

This manual outlines the essential features and functions of the SITRANS LR560 (HART¹⁾). We strongly advise you to acquire the detailed version of the manual so you can use your device to its fullest potential. The complete manual can be downloaded from the SITRANS LR560 product page of our web site at: www.siemens.com/LR560. The printed manual is available from your local Siemens Milltronics representative.

Questions about the contents of this manual can be directed to:

Siemens AG
Siemens Milltronics Process Instruments
1954 Technology Drive, P.O. Box 4225
Peterborough, Ontario, Canada, K9J 7B1
Email: techpubs.smpi@siemens.com

Copyright Siemens AG 2013. All Rights Reserved

We encourage users to purchase authorized bound manuals, or to view electronic versions as designed and authored by Siemens Milltronics Process Instruments. Siemens Milltronics Process Instruments will not be responsible for the contents of partial or whole reproductions of either bound or electronic versions.

Disclaimer of Liability

While we have verified the contents of this manual for agreement with the instrumentation described, variations remain possible. Thus we cannot guarantee full agreement. The contents of this manual are regularly reviewed and corrections are included in subsequent editions. We welcome all suggestions for improvement.

Technical data subject to change.

MILLTRONICS is a registered trademark of Siemens Milltronics Process Instruments.

Technical Support

Support is available 24 hours a day.

To find your local Siemens Automation Office address, phone number, and fax number, go to: www.siemens.com/automation/partner:

- Click on the tab **Contact**, select **Service**, then click **Service** again to find your product group (**+Automation Technology > +Sensor Systems > +Process Instrumentation > +Level Measurement > +Continuous**). Select **Radar**.
- Select the country followed by the City/Region.
- Select **Technical Support** under **Service**.

For on-line technical support go to: www.siemens.com/automation/support-request

- Enter the device name (SITRANS LR560) or order number, then click on **Search**, and select the appropriate product type. Click on **Next**.
- Enter a keyword describing your issue. Then either browse the relevant documentation, or click on **Next** to email a description of your issue to Siemens Technical Support staff.

Siemens IA/DT Technical Support Center: phone +49 (0)911 895 7222

¹⁾ HART® is a registered trademark of HART Communication Foundation.

Safety Guidelines

Warning notices must be observed to ensure personal safety as well as that of others, and to protect the product and the connected equipment. These warning notices are accompanied by a clarification of the level of caution to be observed.



WARNING symbol relates to a caution symbol on the product, and means that failure to observe the necessary precautions can result in death, serious injury, and/or considerable material damage.



WARNING symbol, used when there is no corresponding caution symbol on the product, means that failure to observe the necessary precautions can result in death, serious injury, and/or considerable material damage.

Note: means important information about the product or that part of the operating manual.

FCC Conformity

US Installations only: Federal Communications Commission (FCC) rules



WARNING: Changes or modifications not expressly approved by Siemens Milltronics could void the user's authority to operate the equipment.

Notes:

- This equipment has been tested and found to comply with the limits for a Class A digital device, pursuant to Part 15 of the FCC Rules. These limits are designed to provide reasonable protection against harmful interference when the equipment is operated in a commercial environment.
- This equipment generates, uses, and can radiate radio frequency energy and, if not installed and used in accordance with the instruction manual, may cause harmful interference to radio communications. Operation of this equipment in a residential area is likely to cause harmful interference to radio communications, in which case the user will be required to correct the interference at his own expense.

Industry Canada

- Operation is subject to the following two conditions: (1) this device may not cause interference, and (2) this device must accept any interference, including interference that may cause undesired operation of the device.
- This device shall be installed and operated in a completely enclosed container to prevent RF emission which otherwise can interfere with aeronautical navigation. Installation shall be done by trained installers, in strict compliance with the manufacturer's instructions.
- The use of this device is on a "no-interference, no-protection" basis. That is, the user shall accept operations of high-powered radar in the same frequency band which may interfere with or damage this device. On the other hand, level probing devices found to interfere with primary licensing operations will be required to be removed at the user's expense.

- d) This level probing device is only permitted for installation inside enclosed containers. The installer/user of this device shall ensure that it is at least 10 km from the Penticton radio astronomy station (British Columbia latitude: 49° 19' 12" N, longitude: 119° 37'12" W). For devices not meeting this 10 km separation (e.g. the Okanagan Valley, British Columbia) the installer/ user must coordinate with and obtain the written concurrence of the Director of the Penticton radio astronomy station before the equipment can be installed or operated. The Penticton contact is Tel: 250-493-2277/ fax: 250-493-7767. (In case of difficulty, the Manager, Radio Equipment Standards, Industry Canada, may also be contacted.)

R&TTE Compliance (Europe)

Hereby, Siemens Milltronics Process Instruments, declares that the SITRANS LR560 is in compliance with the essential requirements and other relevant provisions of Directive 1999/5/EC.

The LR560 complies with EN 302 372 for use in closed storage vessels, when installed according to the installation requirements of EN 302 372, and may be used in all EU countries.

The LR560 complies with Draft ETSI EN 302 729 for use outside of closed tanks in most EU countries. (For a list of exceptions, see the LR560 Declaration to EN 302 729, which can be accessed online at www.siemens.com/LR560.) For open air installations, the following conditions must be observed:

Installation and maintenance is performed by suitably qualified and trained personnel.

The LR560 shall be installed only in a permanent fixed position pointing downwards. Its location shall comply with the following two restrictions:

- 1) It shall be installed with a minimum separation distance of 4 km from Radio Astronomy sites listed below unless special authorization has been provided by the responsible national regulatory authority.
- 2) If it is installed at a location between 4 and 40 km from any Radio Astronomy site listed below, the LR560 shall be installed at a height not exceeding 15m from the ground.

Country	Name of Station	Geographic Latitude	Geographic Longitude
France	Plateau de Bure	44°38'01" N	05°54'26" E
	Bordeaux	44°84'00" N	0°52'00" W
Germany	Effelsberg	50°31'32" N	06°53'00" E
Italy	Sardinia	39°29'50" N	09°14'40" E
Spain	Yebes	40°31'27" N	03°05'22" W
	Pico Veleta	37°03'58.3" N	03°23'33.7" W
Sweden	Onsala	57°23'45" N	11°55'35" E

The LR560 Declaration of Conformity may be accessed online at www.siemens.com/LR560.

SITRANS LR560

! WARNING: SITRANS LR560 is to be used only in the manner outlined in this manual, otherwise protection provided by the equipment may be impaired.

Note: This product is intended for use in industrial areas. Operation of this equipment in a residential area may cause interference to several frequency based communications.

SITRANS LR560 is a 2-wire 78 GHz FMCW radar level transmitter for continuous monitoring of solids in vessels to a range of 100 m (329 ft). The plug and play performance is ideal for all solids applications, including those with extreme dust and high temperatures to +200 °C (+392 °F).

The device is an electronic circuit coupled to a lens antenna and flange for quick and easy positioning.

SITRANS LR560 supports HART communication protocol, and SIMATIC PDM software. Signals are processed using Process Intelligence.

Specifications

For a complete listing, see the SITRANS LR560 (HART) Instruction Manual. For Approvals information see *Approvals* on page 5.

Ambient/Operating Temperature

Notes:

- The reference drawing listed on the device label can be downloaded from the Siemens website at: www.siemens.com/LR560 under **Support**.
- Maximum and minimum temperatures are dependent on the process connection, antenna and O-ring materials. Use of the Easy Aimer limits maximum temperature.
- See *Temperature De-Rating Curve* on page 16, for more details.

ambient temperature
(surrounding enclosure)
-40 °C to 80 °C (-40 °F to 176 °F)

process temperature at process connection:

-40 °C to +100 °C (-40 °F to +212 °F) or

-40 °C to +200 °C (-40 °F to +392 °F) depending on the version

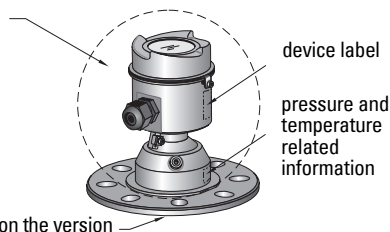

Power



Nominal 24 V DC with
max. 550 Ohm loop resistance¹⁾.

For other configurations, see the chart under
Loop Power on page 16.

- Maximum 30 V DC
- 4 to 20 mA loop power

¹⁾ Check the device label for the characteristics of the device, and confirm the loop load.

Approvals

Notes:

- The device label lists the approvals that apply to your device.
- Use appropriate conduit seals to maintain IP or NEMA rating.

• General	CSA _{US/C} , FM, CE, C-TICK		
• Radio	R&TTE (Europe), FCC, Industry Canada,		
• Hazardous			
	Non-sparking/ Energy Limited ¹⁾	(Europe) (Brazil)	ATEX II 3G Ex nA/nL IIC T4 Gc INMETRO: DNV 12.0085 X Ex nA IIC T4 Gc -40 °C ≤ Ta ≤ +80 °C Un = 32 Vcc DNV #OCP 0017 ABNT NBR IEC 60079-0:2008, ABNT NBR IEC 60079-15:2012
	Dust Ignition Proof ¹⁾	(Europe/International) (Brazil)	ATEX II 1D, 1/2D, 2D IECEx SIR 09.0149X Ex ta IIIC T139°C Da INMETRO: DNV 12.0085 X Ex ta IIIC T139 °C Da IP68 -40 °C ≤ Ta ≤ +80 °C DNV #OCPC 0017 ABNT NBR IEC 60079-0:2008 e ABNT NBR IEC 60079-31:2011
	Dust Ignition Proof ²⁾	(US/Canada)	FM/CSA: Class II, Div. 1, Groups E, F, G Class III T4
	Non-incendive ²⁾	(US/Canada)	FM/CSA Class I, Div. 2, Groups A, B, C, D, T4

Pressure Application



WARNINGS:

- **Do not attempt to loosen, remove, or disassemble process connection or instrument housing while vessel contents are under pressure.**
- **Improper installation may result in loss of process pressure.**

Pressure Equipment Directive, PED, 97/23/EC

Note: Pertains to pressure-rated version only.

SITRANS LR560 Radar Level Measurement instrument falls below the limits of Article 3, sections 1&2 of the Pressure Equipment directive (PED, 97/23/EC), as a category I pressure accessory. However, in accordance with PED, 97/23/EC, Article 3, section 3, this equipment has been designated and manufactured in accordance with Sound Engineering Practice (SEP) (see EU Commission Guideline 1/5).

¹⁾ See also *Non-Sparking/Energy Limited wiring (Europe/Brazil) and Dust Ignition Proof wiring (Europe/International/Brazil)* on page 17.

²⁾ See also *Non-incendive and Dust Ignition Proof wiring (US/Canada)* on page 17.

Installation



WARNINGS:

- Installation shall be performed only by qualified personnel and in accordance with local governing regulations.
- Never attempt to loosen, remove, or disassemble process connection or instrument housing while vessel contents are under pressure.
- The user is responsible for the selection of bolting and gasket materials which will fall within the limits of the flange and its intended use and which are suitable for the service conditions.
- Improper installation may result in loss of process pressure.

Note: SITRANS LR560 units are pressure tested, meeting or exceeding the requirements of the ASME Boiler and Pressure Vessel Code and the European Pressure Equipment Directive.

Nozzle location

Beam angle

- Beam angle is the width of the cone where the energy density is half of the peak energy density.
- The peak energy density is directly in front of and in line with the antenna.
- There is a signal transmitted outside the beam angle, therefore false targets may be detected.

Emission cone

- Keep emission cone free of interference from ladders, pipes, I-beams or filling streams.
- Avoid central locations on tall, narrow vessels.

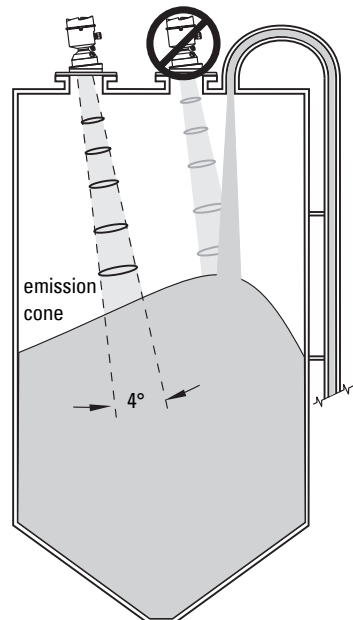

Environment

- Provide easy access for viewing the display and programming via the hand programmer.
- Provide an environment suitable to the housing rating and materials of construction.

Sun Shield

The LR560 display can be protected by an optional sun shield if the instrument will be mounted in direct sunlight

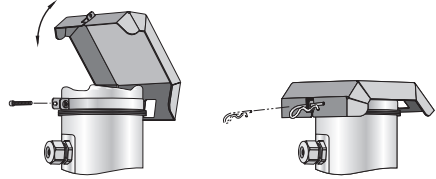

Aimer Adjustment

Aiming is not required for signal optimization with 78 GHz frequency.

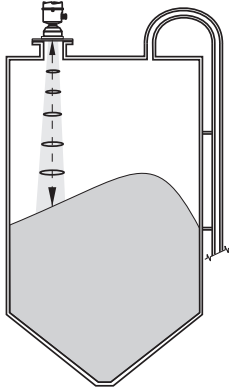

3" flange

Aiming will assist in measuring material in the cone.

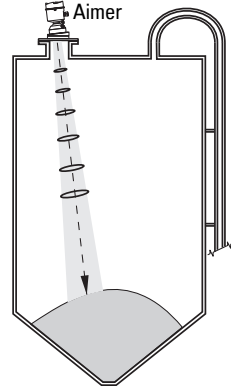

4 and 6" flange

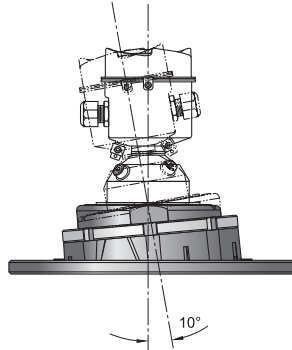
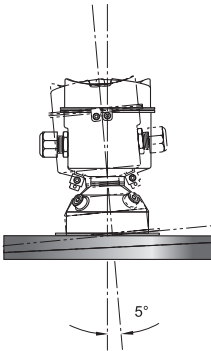

- 1) For 4" and 6" Aimer: Loosen the set screws in the locking ring. Holding the electronics enclosure firmly, loosen the Aimer locking ring using the supplied C spanner, until the LR560 drops down slightly. The enclosure can then be turned freely.
- 2) Direct SITRANS LR560 so the antenna is pointed at an angle perpendicular to the material surface, if possible.

- 3) When the desired position is reached, re-tighten the locking ring using the C spanner, and tighten set screws.
- 4) For the 3" Aimer flange, tapered split washers with pressure rated versions are provided to keep nuts and bolts perpendicular to the flange surface.

Air Purge System

The purge airflow is designed to create a strong vortex of air that rapidly cleans the face of the lens. See the full manual for details.

Wiring

Power

WARNINGS:



The DC input terminals shall be supplied from a source providing electrical isolation between the input and output, in order to meet the applicable safety requirements of IEC 61010-1.



All field wiring must have insulation suitable for rated voltages.

Connecting SITRANS LR560



WARNINGS:

- Check the device label to verify the approval rating.
- Use appropriate conduit seals to maintain IP or NEMA rating.
- Read *Instructions specific to hazardous area installations* on page 18.

Notes:

- Use twisted pair cable: AWG 22 to 14 (0.34 mm² to 2.5 mm²).
- Separate cables and conduits may be required to conform to standard instrumentation wiring practices or electrical codes.

- 1) Loosen locking screw.
- 2) Remove LR560 lid.
- 3) Remove optional display by gently turning the display a quarter turn counter-clockwise until it is free.
- 4) Strip the cable jacket for approximately 70 mm (2.75") from the end of the cable, and thread the wires through the gland ¹⁾.

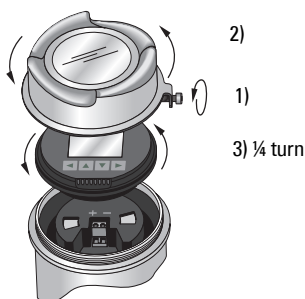

¹⁾ If cable is routed through conduit, use only approved suitable-size hubs for waterproof applications.

- 5) Connect the wires to the terminals as shown: the polarity is identified on the terminal block.
- 6) Ground the instrument according to local regulations.
- 7) Tighten the gland to form a good seal.
- 8) Replace optional display.
- 9) After programming and device configuration, replace device lid and secure the locking screw.

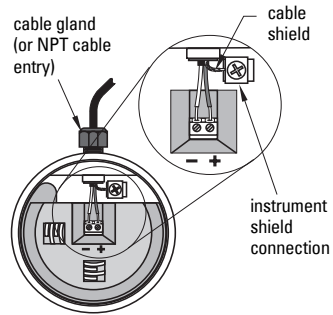

Connecting HART

- Depending on the system design, the power supply may be separate from the PLC, or integral to it.
- HART resistance (total loop resistance, that is, cable resistance plus 250 Ohm [resistor]) must be less than 550 Ohm for the device to function properly.

Wiring setups for hazardous area installations

See page 17

Programming SITRANS LR560

- See *Quick Start Wizard via the LDI push buttons* on page 11.
- See *Quick Start Wizard via SIMATIC PDM* on page 14 or *Operating via AMS Device Manager* on page 15.

Activating SITRANS LR560

Power up the device. A transition screen showing first the Siemens logo and then the current firmware revision is displayed while the first measurement is being processed. SITRANS LR560 automatically starts up in Measurement mode.

The first time the device is configured, you will be prompted to select a language (English, German, French, Spanish or Chinese).

Local Display Interface (LDI)

Modify parameters using the LDI pushbuttons.

(Siemens infrared handheld programmer can be ordered separately: [Part No. 7ML1930-1BK]).



The LCD Display

Measurement mode display (normal operation)

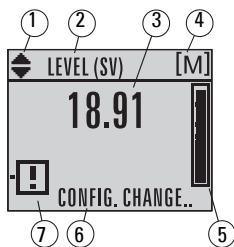

- 1 – toggle indicator¹⁾ for PV or SV (primary or secondary values)
- 2 – selected operation: level, space, or distance
- 3 – measured value (level, space, or distance)
- 4 – units
- 5 – bar graph indicates level
- 6 – text area displays status messages
- 7 – device status indicator

Fault present indicators



S: 0 LOE

When a fault is present the fault code and an error message are displayed in the text area (7), and a service-required icon appears in the device status location (8)

Program mode display

Navigation view

- A visible menu bar indicates the menu list is too long to display all items.
- The depth of the item band on the menu bar indicates the length of the menu list: a deeper band indicates fewer items.
- The position of the item band indicates the approximate position of the current item in the list. A band halfway down the menu bar indicates the current item is halfway down the list. A deeper band indicates fewer items.

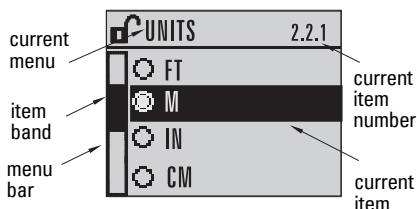

Parameter view

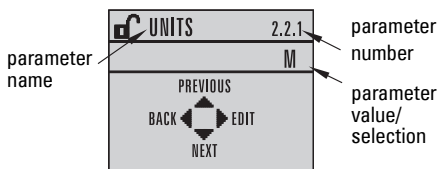

Edit view

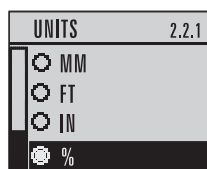

¹⁾ Press ▲ or ▼ to switch.

PROGRAM mode

Using the LDI push buttons, press **▶** to enter Program Mode and open menu level 1. Scroll through the menu using **▲**, **▼**, **▶**, **◀**.

To edit a number

Note: With the Enter icon **↵** highlighted, press **▲** to insert a digit on the right, **▼** to delete the right-most digit, **▶** to accept the value, or **◀** to cancel.

- 1) Navigate to the desired parameter, for example, **Low Calibration point (2.3.1)**, and press **▶** twice to open and edit it. The value will be highlighted.
- 2) Press **▲** or **▼** to delete the highlighted value.
- 3) With the Enter icon highlighted **↵**, press **▲** to add a digit.
- 4) Use **▲** or **▼** to modify the highlighted digit. Scroll past 9 to reach the decimal point.
- 5) Press **◀** to select and highlight the plus or minus sign. Press **▲** or **▼** to change it.
- 6) Press **▶** until the Enter icon is highlighted **↵**, then press **▲** to add a digit on the right.
- 7) When the value is complete, press **▶** until the Enter icon is highlighted **↵**, then press **▶** to accept the value.

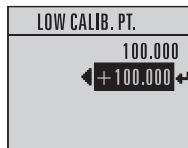

To modify a text string

- 1) Navigate to the parameter you wish to modify and press **▶** to edit it. The string will be highlighted.
- 2) Follow the same steps as above, to add, delete, or modify characters.

Quick Start Wizard via the LDI push buttons

1. Quick Start

Note: Default values are indicated by an asterisk (*) in the tables below, unless explicitly described.

1.1. Quick Start Wizard

- 1) Press **▶** twice to navigate to **Quick Start (1.)** and open **Quick Start Wizard (1.1.)**
- 2) At each step, press **▼** to accept default values and move directly to the next item, or **▶** to open Edit mode: the current selection is highlighted.
- 3) Scroll to desired item and press **▶** to store the change, then press **▼** to continue.
- 4) At any time, you can press **▲** to go back, or **◀** to cancel and return to Measurement mode.



Vessel

Select vessel construction material.

Options	*	STEEL
		CONCRETE

Parameter View

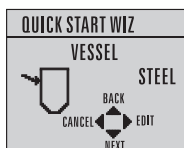

Edit mode

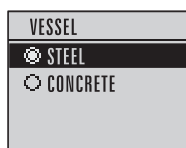

Response Rate

Sets the reaction speed of the device to measurement changes in the target range.

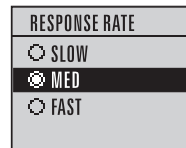
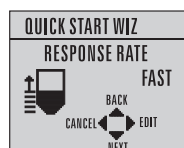

Response Rate	Vessel Fill Rate or Empty Rate per minute	Damping Filter
SLOW	0.1 m/min (0.32 ft/min)	600 s
MED	* 1.0 m/min (3.28 ft/min)	60 s
FAST	10.0 m/min (32.8 ft/min)	0 s

Use a setting just faster than the maximum vessel filling or vessel emptying rate (whichever is greater).

Units

Sensor measurement units.

Values	m, cm, mm, ft, in Default: m
--------	---------------------------------

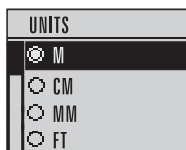

Operation

(See illustration under *Operation (continued)* on page 13.)

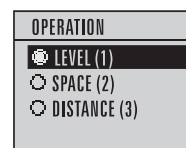
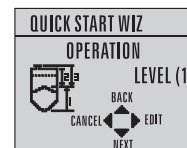

Operation	Description
LEVEL (1)	* Distance from Low Calibration Point to material surface
SPACE (2)	Distance from High Calibration Point to material surface
DISTANCE(3)	Distance from Sensor Reference Point to material surface

Operation (continued)

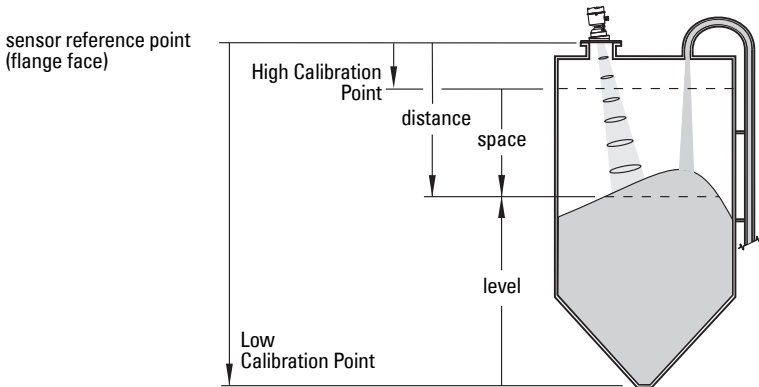

Low Calibration Point

Distance from Sensor Reference Point to Low Calibration Point: usually process empty level.

Values	Range: 0.000 to 40.000 m or 0.000 to 100.000 m
	Default: 40.000 m or 100.000 m

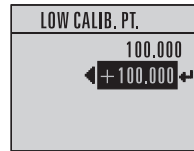
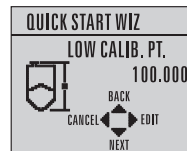

High Calibration Point

Distance from Sensor Reference Point to High Calibration Point: usually process full level.

Values	Range: 0.000 to 40.000 m or 0.000 to 100.000 m
	Default: 0.000 m

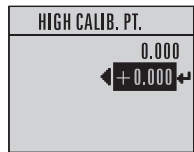

Wizard Complete

Options	BACK, CANCEL, FINISH (Display returns to 1.1 Quick Start Wizard menu when Quick Start is successfully completed.)
----------------	---

To transfer Quick Start values to the device and return to Program menu, press ▼ (**Finish**). Then press ◀ to return to Measurement mode.

SITRANS LR560 Communications: HART

- You will need the full manual to acquire the list of applicable parameters.
- We recommend that you use SIMATIC Process Device Manager (PDM) to program your device.
- Application Guides for setting up HART devices with SIMATIC PDM can be downloaded from the product page of our website at: www.siemens.com/LR560 under **Support**.

SIMATIC PDM

SIMATIC PDM is a software package used to commission and maintain SITRANS LR560 and other process devices. Please consult the operating instructions or online help for details on using SIMATIC PDM. You can find more information at www.siemens.com/simatic-pdm.

Check the support page of our website to make sure you have the latest version of SIMATIC PDM, the most recent Service Pack (SP) and the most recent hot fix (HF). Go to:

<https://support.automation.siemens.com/WW/llisapi.dll?func=cslib.csinfo&lang=en&siteid=csius&aktprim=0&extranet=standard&viewreg=WW&objid=10806857&treeLang=en>

Update Electronic Device Description (EDD)

You can locate the EDD in Device Catalog, under **Sensors/Level/Echo/Siemens AG/SITRANS LR560**.

To install a new EDD

- Go to www.siemens.com/LR560 > **Support** > **Software Downloads** to download the most up-to-date EDD.
- Save the files to your computer and extract the zipped file to an easily accessed location.
- Launch **SIMATIC PDM – Manage Device Catalog**, browse to the unzipped EDD file and select it.

Configuring a new device

Note: Clicking on **Cancel** during an upload from device to SIMATIC PDM will result in some parameters being updated.

- 1) Check that you have the most recent EDD, and if necessary update it (see *To install a new EDD*, above).
- 2) Launch SIMATIC Manager and create a new project for LR560.
- 3) Open the menu **Device – Master Reset** and click **Factory Defaults**.
- 4) After the reset is complete click **Close**, and then upload parameters to the PC/PG.
- 5) Configure the device via the Quick Start wizard.

Quick Start Wizard via SIMATIC PDM

Notes:

- The Quick Start wizard settings are inter-related and changes apply only after you click on **FINISH AND DOWNLOAD** at the end of the last step, to save settings offline and transfer them to the device.
- Click **BACK** to return and revise a setting or **Cancel** to exit the Quick Start.

Launch SIMATIC PDM, open the menu **Device – Wizard - Quick Start**, and follow steps 1 to 4.

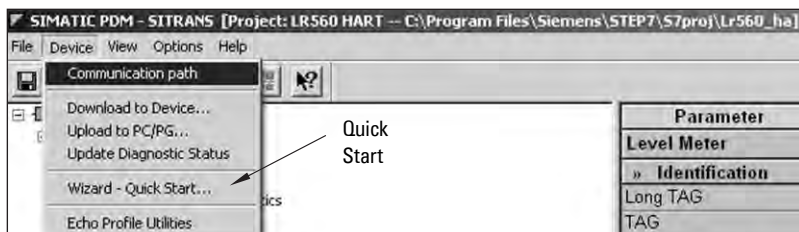

Operating via FDT (Field Device Tool)

FDT is a standard used in several software packages designed to commission and maintain field devices. Two commercially available FDTs are PACTware and Fieldcare.

To configure a field device via FDT you need the DTM (Device Type Manager) for the device. Siemens instruments use SITRANS DTM and an instrument EDD written for SITRANS DTM.

- 1) First install SITRANS DTM on your system. You can download it from:

<http://support.automation.siemens.com>. Click on **Product Support**, and navigate to **Product Information/Automation Technology/Sensor systems/Process Instrumentation/Software & Communications**.

- 2) Install the SITRANS LR560 HART EDD for SITRANS DTM. You can download it from the product page of our website at: www.siemens.com/LR560. Go to **Support > Software Downloads**.

Configuring a new device via FDT

An Application Guide can be downloaded from the product page of our website under **Support**.

Operating via AMS Device Manager

AMS Device Manager is a software package designed to commission and maintain field devices. Please consult the operating instructions or online help for details on using AMS Device Manager. You can find more information at: <http://www.emersonprocess.com/AMS/>.

Electronic Device Description (EDD)

SITRANS LR560 requires the EDD for AMS Device Manager version 9.0.

Configuring a new device via AMS Device Manager

- 1) Check the product page of our website at: www.siemens.com/LR560 to make sure you have the most recent EDD. Go to **Support > Software Downloads** and if necessary download it. Save the files to your computer, and extract the zipped file to an easily accessed location.
- 2) Launch **AMS Device Manager– Add Device Type**, browse to the unzipped EDD file and select it.

Launch AMS Device Manager. An Application Guide for setting up HART devices with AMS Device Manager can be downloaded from the product page of our website under **Support**

Maintenance

SITRANS LR560 requires no maintenance or cleaning under normal operating conditions. If cleaning becomes necessary:

- 1) Note the antenna material and the process medium, and select a cleaning solution that will not react adversely with either.
- 2) Remove the device from service and wipe the antenna clean using a cloth and suitable cleaning solution.

Unit Repair and Excluded Liability

For detailed information, please see the inside back cover.

Temperature De-Rating Curve

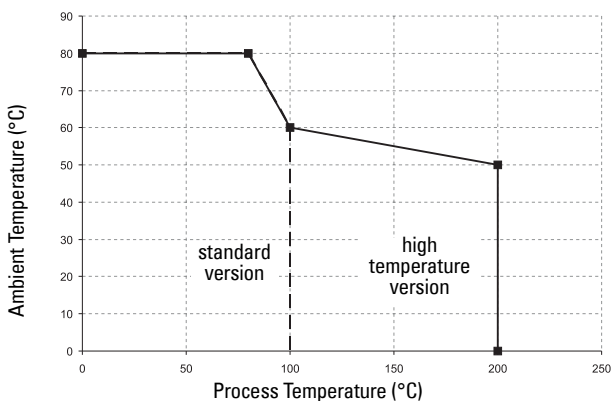

! WARNING: Never attempt to loosen, remove or disassemble process connection or instrument housing while vessel contents are under pressure.

Loop Power

Allowable operating area of SITRANS LR560

Loop Voltage versus Loop Resistance

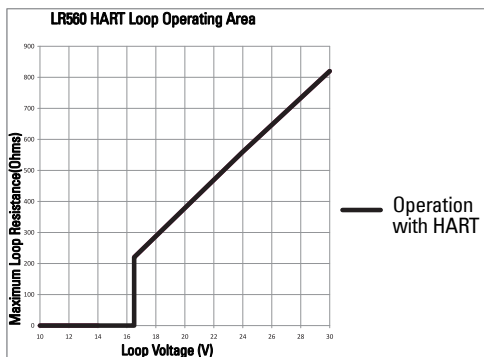

Startup Behavior

- The device draws less than 3.6 mA at startup.
- Time to first measurement is less than 50 seconds

Instructions specific to hazardous area installations (Reference European ATEX Directive 94/9/EC, Annex II, 1.0.6)

Note: Installation shall be performed only by qualified personnel and in accordance with local governing regulations.

The following instructions apply to equipment covered by certificate numbers Sira 09ATEX9356X and Sira 09ATEX4357X:

- 1) For use and assembly and details of marking/coding, refer to the main instructions.
- 2) The equipment is certified for use as Category 1D, 1/2D and 2D equipment per certificate Sira 09ATEX9356X and may be used in hazardous zones 20, 21 and 22. The equipment is also certified for use as Category 3G equipment per certificate Sira 09ATEX4357X and may be used in hazardous zone 2.
- 3) This equipment has a maximum surface temperature of 139 °C (in an 80°C ambient). Refer to the applicable code of practice for selection of this equipment with respect to specific dust ignition temperatures.
- 4) The equipment is certified for use in an ambient temperature range of -40 °C to 80 °C.
- 5) The equipment has not been assessed as a safety related device (as referred to by Directive 94/9/EC Annex II, clause 1.5).
- 6) Installation and inspection of this equipment shall be carried out by suitably trained and authorized personnel in accordance with the applicable code of practice.
- 7) The equipment shall be installed such that the supply cable is protected from mechanical damage. The cable shall not be subjected to tension or torque. The equipment manufacturer is not responsible for providing the supply cable.
- 8) Repair of this equipment shall be carried out by suitably trained and authorized personnel in accordance with the applicable code of practice.

See *SPECIAL CONDITIONS FOR SAFE USE* on page 18

SPECIAL CONDITIONS FOR SAFE USE

The 'X' suffix to the certificate number relates to the following special condition(s) for safe use:

- Parts of the enclosure may be non-conducting and may generate an ignition-capable level of electrostatic charge under certain extreme conditions. The user should ensure that the equipment is not installed in a location where it may be subjected to external conditions (such as high-pressure steam), which might cause a build-up of electrostatic charge on non-conducting surfaces.
- The end user must ensure that an ingress protection of at least IP65 is maintained at each entry to the enclosure by use of a blanking element or cable entry device that meets the requirements of the protection concepts type 'n' or increased safety 'e' or flameproof 'd'.
- The supply to the equipment shall be rated for a prospective short-circuit current of not more than 10 kA and shall be protected by a suitably-rated fuse.