

Ultrasonic flowmeters

SITRANS FUT1010 IP65 NEMA 4X & IP66 NEMA 7
7ME363 Gas Flowmeter

Operating Instructions - March 2011

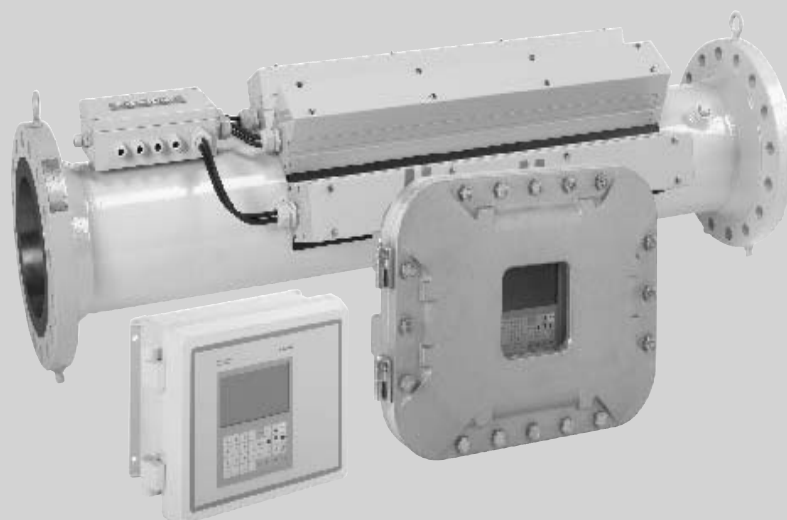

SITRANS F

SIEMENS

SIEMENS

SITRANS F

Ultrasonic Flowmeters FUT1010 IP65 NEMA 4X & IP66 NEMA 7 Gas Flowmeter

Operating Instructions

<u>Introduction</u>	1
<u>Safety notes</u>	2
<u>Description</u>	3
<u>Installing/mounting</u>	4
<u>Connecting</u>	5
<u>Commissioning</u>	6
<u>Factory Default Parameters</u>	7
<u>User Programmable Parameters</u>	8
<u>Functions</u>	9
<u>Alarm, error, and system messages</u>	10
<u>Maintenance and service</u>	11
<u>Troubleshooting/FAQs</u>	12
<u>Technical data</u>	13
<u>Appendix</u>	A
<u>Appendix</u>	B

Legal information

Warning notice system

This manual contains notices you have to observe in order to ensure your personal safety, as well as to prevent damage to property. The notices referring to your personal safety are highlighted in the manual by a safety alert symbol, notices referring only to property damage have no safety alert symbol. These notices shown below are graded according to the degree of danger.

⚠ DANGER
indicates that death or severe personal injury will result if proper precautions are not taken.
⚠ WARNING
indicates that death or severe personal injury may result if proper precautions are not taken.
⚠ CAUTION
with a safety alert symbol, indicates that minor personal injury can result if proper precautions are not taken.
CAUTION
without a safety alert symbol, indicates that property damage can result if proper precautions are not taken.
NOTICE
indicates that an unintended result or situation can occur if the corresponding information is not taken into account.

If more than one degree of danger is present, the warning notice representing the highest degree of danger will be used. A notice warning of injury to persons with a safety alert symbol may also include a warning relating to property damage.

Qualified Personnel

The product/system described in this documentation may be operated only by **personnel qualified** for the specific task in accordance with the relevant documentation for the specific task, in particular its warning notices and safety instructions. Qualified personnel are those who, based on their training and experience, are capable of identifying risks and avoiding potential hazards when working with these products/systems.

Proper use of Siemens products

Note the following:

⚠ WARNING
Siemens products may only be used for the applications described in the catalog and in the relevant technical documentation. If products and components from other manufacturers are used, these must be recommended or approved by Siemens. Proper transport, storage, installation, assembly, commissioning, operation and maintenance are required to ensure that the products operate safely and without any problems. The permissible ambient conditions must be adhered to. The information in the relevant documentation must be observed.

Trademarks

All names identified by ® are registered trademarks of the Siemens AG. The remaining trademarks in this publication may be trademarks whose use by third parties for their own purposes could violate the rights of the owner.

Disclaimer of Liability

We have reviewed the contents of this publication to ensure consistency with the hardware and software described. Since variance cannot be precluded entirely, we cannot guarantee full consistency. However, the information in this publication is reviewed regularly and any necessary corrections are included in subsequent editions.

Table of contents

1	Introduction.....	9
1.1	Items supplied.....	9
1.2	Preface.....	9
1.3	History.....	9
1.4	Further Information.....	10
2	Safety notes.....	11
2.1	General safety instructions.....	11
2.2	Laws and directives.....	11
2.3	Lithium batteries.....	12
2.4	Installation in hazardous area.....	13
2.5	Safety Notes.....	15
2.6	Pressure Equipment Safety Notes.....	19
2.7	Certificates.....	20
3	Description.....	21
3.1	FUT1010 features.....	21
3.2	NEMA 4X & NEMA 7 Transmitters.....	24
3.3	Applications.....	26
3.4	Theory of Operation.....	27
4	Installing/mounting.....	33
4.1	Determining a location.....	33
4.2	Use according to specifications.....	33
4.3	Application Guidelines.....	34
4.4	Mounting the Transmitter.....	34
4.5	Sensor Label Information.....	36
4.6	Sensor Installation Procedure.....	37
5	Connecting.....	43
5.1	Safety notes for connecting.....	43
5.2	Transmitter Wiring.....	44
5.2.1	Connecting Power.....	44
5.2.2	Connecting Sensor Cables to Transmitter.....	47
5.2.3	Wiring Temperature Sensor to Transmitter.....	48
5.3	Sensor Wiring.....	51

5.3.1	Connecting Sensor Cables to Sensor	51
5.3.2	Wiring Temperature Cable to Sensor	54
6	Commissioning	55
6.1	General requirements	55
6.2	Commissioning.....	55
6.3	Navigating the Menu	57
6.4	Installation Menus	59
7	Factory Default Parameters	63
7.1	Factory Default Menu Settings.....	63
7.2	Force Transmit.....	68
8	User Programmable Parameters	71
8.1	User Programmable Menu Settings.....	71
8.2	Selecting Flow Units.....	73
8.3	Span Data	78
8.4	Analog Output Setup.....	83
8.5	Analog Input Setup.....	85
8.6	Logger Control	88
9	Functions.....	93
9.1	Gas Parameters Menu.....	93
9.2	Gas Data Menu	101
9.3	Operation Adjust Menu Settings	102
9.4	Setting Relays	104
9.5	Memory Control.....	107
9.6	Analog Output Trim	108
9.7	Resistive Temperature Device (RTD) Calibration.....	112
10	Alarm, error, and system messages	115
10.1	Alarm Letter Codes and Descriptions	115
11	Maintenance and service	117
11.1	Maintenance.....	117
11.2	Technical support.....	117
11.3	Return procedures	118
11.4	Battery disposal.....	119
12	Troubleshooting/FAQs.....	121
12.1	Troubleshooting	121
12.2	F4 Reset Procedure	122

12.3	Test Facilities Graph Screen.....	124
13	Technical data	139
13.1	Technical Data	139
A	Appendix.....	141
A.1	Accessories and spare parts.....	141
A.2	I/O Connections and Wiring	141
A.3	Site Setup For SITRANS F	147
A.4	Flowrate Calibration and Calibration Tables.....	155
A.5	Setting Thermal Coefficient and Modulus of Elasticity	158
B	Appendix.....	161
B.1	Installation/Outline Drawings	161
	Glossary	163
	Index.....	169

Tables

Table 4- 1	Hazardous Area Ratings.....	41
Table 5- 1	TB3 and TB4 Wiring.....	50
Table 6- 1	Keypad Function Chart	58
Table 7- 1	Common Gases for Clamp-On Measurement (at 200 psia & 60°F / 14 bar & 15.5°C)	65
Table 7- 2	Pipe Configuration Option List Definitions	67
Table 8- 1	Totalizer Modes	75
Table 8- 2	Totalizer Controls (the "n" in <Fn> = channel number)*	77
Table 8- 3	Input/Output Wiring (TB2) - 7ME39400AL03 Expanded I/O Module.....	80
Table 8- 4	Open Collector User Resistor Recommendations	81
Table 8- 5	Analog Outputs	83
Table 8- 6	Analog Out Setup Data Categories	83
Table 8- 7	I/O Data Control Menu	86
Table 8- 8	Logger Control Menu Option List.....	88
Table 9- 1	Gas Flowmeters Menu Structure and Default Values	94
Table 9- 2	Syntax Rules	99
Table 9- 3	Example #1 - Density (kg-m/m3) vs. Pressure and Temperature	99
Table 9- 4	Z-factor vs. Pressure and Temperature.....	100
Table 9- 5	Example #2	100
Table 9- 6	Gas Data Menu Items	101
Table 9- 7	Relay Option List.....	105

Table 9- 8	Memory Control Menu.....	107
Table 9- 9	Analog Out Trim Menu Structure	108
Table 9- 10	RTD Calibrate Menu Structure.....	112
Table 10- 1	Alarm Codes and Descriptions	115
Table 12- 1	Troubleshooting Tips.....	121
Table 12- 2	Description of Graph Screen Text Display Parameters	132
Table 12- 3	Hot Key Summary	133
Table 12- 4	Site Setup Menu Items.....	134
Table A- 1	Connection Diagrams and Part Numbers	141
Table A- 2	Input/Output Wiring (TB2) - 7ME39400AL04 Expanded I/O Module.....	142
Table A- 3	Input/Output Wiring (TB3) - 7ME39400AL04 Expanded I/O Module.....	144
Table A- 4	Input/Output Wiring (TB4) - 7ME39400AL04 Expanded I/O Module.....	145
Table A- 5	Open Collector User Resistor Recommendations	146

Figures

Figure 3-1	SITRANS FUT1010 Flowmeter.....	22
Figure 3-2	Typical Transmitter label	24
Figure 3-3	NEMA 4X Transmitter Case.....	25
Figure 3-4	NEMA 7 Case Enclosure with graphic display and keypad	26
Figure 4-1	Pipe Mounting and Mounting Locations for Transmitter	35
Figure 4-2	Sample Sensor Label.....	37
Figure 4-3	Sensor Installation.....	39
Figure 4-4	Hazardous Location Sensor Installation	40
Figure 5-1	Input Power Plug (P10) Wiring.....	45
Figure 5-2	Sensor Cable Connections	47
Figure 5-3	Analog Input Module Access.....	49
Figure 5-4	Temperature Sensor to Junction Box Wiring	50
Figure 5-5	Sensor Overview.....	51
Figure 5-6	Sensor Cable Installation	52
Figure 5-7	Sensor Interconnection Diagram	53
Figure 5-8	Temperature Sensor Board to Junction Box Wiring	54
Figure 6-1	Startup Screen	56
Figure 6-2	Keypad	57
Figure 6-3	Typical Installation Menu Screen	58

Figure 8-1	7ME39400AL03 Main Board I/O Wiring.....	80
Figure 12-1	Test Facilities Graph Screen.....	125
Figure 12-2	Setting Digital Damping Factor	128
Figure 12-3	Setting MinDamp Factor	129
Figure 12-4	Envelope Threshold Adjustment.....	131
Figure A-1	7ME39400AL04 Expanded I/O Module	141
Figure A-2	7ME39400AL03 TB2 Expanded I/O Wiring	143
Figure A-3	7ME39400AL03 TB3 I/O Relay Wiring	144
Figure A-4	7ME39400AL03 TB4 Expanded I/O Wiring	145
Figure A-5	7ME39400AL03 Main Board I/O Wiring.....	146

Introduction

1.1 Items supplied

- SITRANS F Flowmeter (Transmitter and Sensor)
- SITRANS F literature CD
- Applicable documentation including certifications
- For additional items refer to your packing slip.

1.2 Preface

These instructions contain all the information you need for using the device.

The instructions are aimed at persons mechanically installing the device, connecting it electronically, configuring the parameters and commissioning it as well as service and maintenance engineers.

Note

It is the responsibility of the customer that the instructions and directions provided in the manual are read, understood and followed by the relevant personnel before installing the device.

1.3 History

The contents of these instructions are regularly reviewed and corrections are included in subsequent editions. We welcome all suggestions for improvement.

The following table shows the most important changes in the documentation compared to each previous edition.

Edition	Remarks
01 02/2010	First edition of Operating Instructions for SITRANS FUT1010 IP65 NEMA 4X & IP66 NEMA 7 gas flow meter.
02 06/2010	Second edition of Operating Instructions for SITRANS FUT1010 IP65 NEMA 4X & IP66 NEMA 7 gas flow meter. The most important changes are as follows: <ul style="list-style-type: none"><li data-bbox="480 562 735 600">• Sensor label update
03 03/2011	Third edition of Operating Instructions for SITRANS FUT1010 IP65 NEMA 4X & IP66 NEMA 7 gas flow meter. This document replaces all previous instructions for use. The most important changes are as follows: <ul style="list-style-type: none"><li data-bbox="480 719 715 757">• PED pending note<li data-bbox="480 757 735 795">• Safety note updates<li data-bbox="480 795 788 831">• Transmitter Label update

1.4 Further Information

The contents of these Operating Instructions shall not become part of or modify any prior or existing agreement, commitment or legal relationship. All obligations on the part of Siemens AG are contained in the respective sales contract which also contains the complete and solely applicable warranty conditions. Any statements contained herein do not create new warranties or modify the existing warranty.

Product information on the Internet

The Operating Instructions are available on the CD-ROM shipped with the device, and on the Internet on the Siemens homepage, where further information on the range of SITRANS F flowmeters may also be found: Product information on the Internet (<http://www.siemens.com/flow>)

Worldwide contact person

If you need more information or have particular problems not covered sufficiently by the operating instructions, please get in touch with your contact person. You can find contact information for your local contact person on the Internet: www.siemens.com Local contact person (<http://www.automation.siemens.com/partner>)

Safety notes

2.1 General safety instructions

 CAUTION
<p>Correct, reliable operation of the product requires proper transport, storage, positioning and assembly as well as careful operation and maintenance. Only qualified personnel should install or operate this instrument.</p>

Note

Alterations to the product, including opening or improper repairs of the product, are not permitted.

If this requirement is not observed, the CE mark and the manufacturer's warranty will expire.

2.2 Laws and directives

General requirements

Installation of the equipment must comply with national regulations. For example, the National Electrical Codes.

Instrument safety standards

The device has been tested at the factory, based on the safety requirements. In order to maintain this condition over the expected life of the device the requirements described in these Operating Instructions must be observed.

CAUTION
<p>Material compatibility</p> <p>Siemens can provide assistance with the selection of sensor parts. However, the full responsibility for the selection rests with the customer and Siemens can take no responsibility for any failure due to material incompatibility.</p>

CE marked equipment

The CE-mark symbolizes the compliance of the device with the following Directives:

- EMC-Directive 2004/108/EC
- Low voltage Directive 2006/95/EC
- Pressure equipment Directive (PED) 97/23/EC (pending)
- ATEX Directive 94/9/EC

2.3 Lithium batteries

Lithium batteries are primary power sources with high energy content designed to represent the highest possible degree of safety.

 WARNING
Potential hazard Lithium batteries may present a potential hazard if they are abused electrically or mechanically. This is in most circumstances associated with the generation of excessive heat where internal pressure may cause the cell to rupture. Thus the following basic precautions should be observed when handling and using lithium batteries: <ul style="list-style-type: none">• Do not short-circuit, recharge or connect with false polarity.• Do not expose to temperature beyond the specified temperature range or incinerate the battery.• Do not crush, puncture or open cells or disassemble battery packs.• Do not weld or solder to the battery's body.• Do not expose contents to water.

2.4 Installation in hazardous area

 WARNING
Explosion Hazard Equipment used in hazardous areas must be Ex-approved and marked accordingly. It is required that the special conditions for safe use provided in the manual and in the Ex certificate are followed!

Hazardous area approvals

The device is approved for use in hazardous area and has the following approval:

- FM and CSA certified
- Class I, Division 1, Groups ABCD
- Class II, Division 1, Groups EFG
- ATEX

 WARNING
Explosion Hazard Make sure the hazardous area approval is suitable for the environment in which the device will be installed.

Intrinsically safe data

 WARNING
Explosion Hazard User must install unit with Siemens drawings. With intrinsically safe circuits, use only certified meters appropriate for the transmitter. If a non-conforming supply unit is used, the "fail-safe" type of protection will no longer be effective and the approval certification will be invalid.

Hazardous area safety requirements

It is required that:

- Electrical connections are in accordance with EN60079-14 (Installing Electrical Systems in Explosion Hazardous Areas).
- The protective cover over the power supply is properly installed. For intrinsically safe circuits the connection area can be opened.

2.4 Installation in hazardous area

- Appropriate cable connectors are used for the output circuits:
 - Intrinsically safe: blue
 - Non-intrinsically safe: black
- Sensor and transmitter are connected to the potential equalization.
For intrinsically safe output circuits potential equalization must be maintained along the entire connection path.
- When protective earth (PE) is connected, no potential difference between the protective earth (PE) and the potential equalization (PA) can exist, even during a fault condition.

 WARNING
Explosion Hazard "Flameproof enclosure" type of protection Only open devices with type of protection "Flameproof enclosure" (e.g. FUT1010 NEMA 7) in hazardous areas when the power to the device is turned off, otherwise there is a risk of explosion.

 WARNING
Explosion Hazard Laying of cables Cable for use in zone 1 and 2 must satisfy the requirements for having a proof voltage < AC 500 V applied between the conductor/ground, conductor/shield and shield/ground. Connect the devices that are operated in hazardous areas as per the stipulations applicable in the country of operation, e.g. for Ex "d" and "nA", permanent cables must be laid.

 WARNING
Explosion Hazard Devices with the common approval "Intrinsically safe" and "Flameproof" The following is applicable for devices with the common approval "Intrinsically safe" and "Flameproof" (Ex ia + Ex d): Before commissioning, make sure that the type of protection that is not suitable is permanently defaced on the nameplate to avoid improper use. If a non-conforming infeed is used, the "fail-safe" type of protection will no longer be effective.

2.5 Safety Notes

Safety Information for Hazardous Areas



! DANGER
Explosion Hazard. Will Cause Death, Serious Injury or Property Damage.
Restrict use and repair to qualified personnel.

! DANGER
Explosion Hazard
Death or severe personal injury and/or equipment and property damage will result if proper Hazardous (Classified) Locations installation precautions are not taken.

! DANGER
Explosion Hazard
The use of unauthorized parts in the repair of the equipment, tampering by unqualified personnel, or operation with the cover open in a Hazardous (Classified) Location will result in dangerous conditions which will cause death, serious injury, and/or equipment and property damage.

Follow all safety instructions contained or referenced herein.

! DANGER
Explosion Hazard
Death or severe personal injury and/or equipment and property damage will result due to improper installation or use of this equipment when located in a Hazardous (Classified) Location.

- Install as directed.
- Disconnect power source before servicing.
- Keep cover closed when equipment is operating.

 **WARNING**

Qualified personnel

This flow meter system may only be set up and used in conjunction with this document and the instructions on the electronic media provided. Installation, maintenance and operation of the flow meter system may only be performed by qualified personnel. Within the context of this Document, qualified persons are defined as persons who have the skills and knowledge related to the construction and operation of the electrical equipment and installations and have received safety training to recognize and avoid the potentially explosive hazards involved.

Qualified personnel posses the following qualifications

1. Is trained and authorized to energize, de-energize, clear, ground and tag circuits and equipment in accordance with established safety practices.
2. Is trained in the proper care and use of protective equipment such as rubber gloves, hard hat, safety glasses or face shields, flash clothing, etc., in accordance with established safety practices.
3. Is trained in rendering first aid.

Note

This document does not purport to cover all details or variations in equipment, or to provide for every possible contingency to be met in connection with installation, operation or maintenance. Should further information be desired or should particular problems arise, which are not covered sufficiently for the purchaser's purposes, the matter should be referred to the local Siemens sales office (www.automation.siemens.com/partner). The contents of this Document shall not become part of or modify any prior or existing agreement, commitment or relationship. The sales contract contains the entire obligation of Siemens. The warranty contained in the contact between the parties is the sole warranty of Siemens. Any statements contained herein do not create new warranties or modify the existing warranty.

Safety Information for Hazardous Areas

Note

Ratings under this heading apply to specific model families.

Check Your Model Number: FUT1010, 7ME363x.

FM-CSA installation

Read, understand and follow all safety instructions on the electronic media provided. This equipment is rated for use in hazardous (classified) locations as stated below and must be installed according to the 1010-304 installation drawing provided on the media. Failure to install the equipment in the prescribed manner will result in unsafe operation. Follow all local jurisdictional safety codes when operating this equipment. When properly installed the equipment meets the following FM – CSA ratings.

Transmitter

- Intrinsically safe connections Class I and II, Division 1, Groups A, B, C, D, E, F and G;
- Nonincendive for Class I, Division 2, Groups A, B, C and D;
- Suitable for Class II, Division 2, Groups E, F and G outdoor (Type 4X), Class III (CSA only)
- Temperature code T5 at an ambient of 40°C



Sensors

- Intrinsically safe Class I and II, Division 1, Groups A, B, C, D, E, F and G;
- Nonincendive for Class I, Division 2, Groups A, B, C and D;
- Suitable for Class II, Division 2, Groups E, F and G outdoor (Type 4X), Class III (CSA only)
- Temperature code T6 at an ambient of 40°C

ATEX installation

Read, understand and follow all safety instruction on the electronic media provided. This equipment complies with Directive 94/9/EC and is rated for use in potentially explosive atmospheres. The equipment markings are shown and explained below. Equipment must be installed according to the 1010-389 installation drawing provided on the media. Failure to install the equipment in the prescribed manner will result in unsafe operation. Follow all regional safety laws when operating this equipment. When properly installed the equipment meets the following ATEX ratings as stated in EC-Type Examination Certificate KEMA03ATEX1134.

Transmitter Markings and Explanations

- II (1) G [Ex ia] IIC – Transmitter located in the non-hazardous area with intrinsically safe circuits of category Ex ia, which can be connected to Category 1 Sensors
- II 3 (1) G Ex nC [ia] IIC T5 – Category 3 Transmitter located in Zone 2 for use in potentially explosive atmosphere containing gases with intrinsically safe circuits of category Ex ia, which can be connected to Category 1 Sensors in Zone 0
- IP65 – Ingress protection against solid bodies, rating of dust-tight and against liquid, rating of water jets

Sensor Markings and Explanations

- II 1 G Ex ia IIC T5 – Category 1 Sensors located in Zone 0 potentially explosive atmosphere with intrinsically safe circuits of category Ex ia for use in potentially explosive atmosphere containing gases

Safety Information for Hazardous Areas

Note

Ratings under this heading apply to specific model families.

Check Your Model Number: FUT1010, 7ME363x.

FM-CSA installation

Read, understand and follow all safety instruction on the electronic media provided. This equipment is rated for use in hazardous (classified) locations as stated below and must be installed according to the 1010-443 installation drawing provided on the media. Failure to install the equipment in the prescribed manner will result in unsafe operation. Follow all local jurisdictional safety codes when operating this equipment. When properly installed the equipment meets the following FM – CSA ratings:

Transmitter

- Explosionproof for Class I, Division 1, Groups B, C, D;
- Dust-ignitionproof for Class II, Division 1, Groups E, F and G;
- Intrinsically safe connections for Class I and II, Division 1, Groups A, B, C, D, E, F and G;
- Nonincendive for Class I, Division 2, Groups A, B, C and D;
- Suitable for Class II, Division 2, Groups E, F and G outdoor (Type 4X), Class III (CSA only)





Sensors

- Intrinsically safe Class I and II, Division 1, Groups A, B, C, D, E, F and G;
- Nonincendive for Class I, Division 2, Groups A, B, C and D;
- Suitable for Class II, Division 2, Groups E, F and G outdoor (Type 4X), Class III (CSA only)
- Temperature code T6 at an ambient of 40°C

ATEX installation

Read, understand and follow all safety instruction on the electronic media provided. This equipment is rated for use in explosive atmospheres as stated below and must be installed according to the 1010-464 installation drawing provided on the media. Failure to install the equipment in the prescribed manner will result in unsafe operation. Follow all regional safety laws when operating this equipment. When properly installed the equipment meets the following ATEX ratings as stated in EC-Type Examination Certificate KEMA03ATEX1134.





Transmitter Markings and Explanations







-  II (1) G [Ex ia] IIC – Transmitter located in the non-hazardous area with intrinsically safe circuits of category Ex ia, which can be connected to Category 1 Sensors for use in potentially explosive atmosphere containing gases
-  II 3 (1) G Ex nC [ia] IIC T5 (Tamb = 0° To + 60°C) – Category 3 Transmitter located in Zone 2 potentially explosive atmosphere with intrinsically safe circuits of category Ex ia, which can be connected to Category 1 Sensors in Zone 0 for use in potentially explosive atmosphere containing gases
-  II 2 (1) G Ex d [ia IIC] IIB T5 (Tamb = 0° To + 50°C) – Category 2 Transmitter located in Zone 1 potentially explosive atmosphere with intrinsically safe circuits of category Ex ia, which can be connected to Category 1 Sensors for use in potentially explosive atmosphere containing gases
-  II 2 (1) G Ex d [ia IIC] IIB+H2 T5 (Tamb = 0° To + 50°C) – Category 2 flow meter located in Zone 1 potentially explosive atmosphere with intrinsically safe circuits of category Ex ia, which can be connected to Category 1 transducers for use in potentially explosive atmosphere containing gases
- IP66 – Ingress protection against solid bodies, rating of dust-tight and against liquid, rating of heavy seas

Sensor Markings and Explanations

-  II 1 G Ex ia IIC T5 – Category 1 Sensors located in Zone 0 potentially explosive atmosphere with intrinsically safe circuits of category Ex ia for use in potentially explosive atmosphere containing gases

2.6 Pressure Equipment Safety Notes

 WARNING
HOT SURFACE - External Sensor temperature can exceed 93°C (200°F).
 WARNING
Exceeding rated pressure identified as MAOP may cause Sensor failure.
 WARNING
User is responsible for ensuring that all Sensor ports are properly sealed.
 WARNING
It is the responsibility of the user to account for any potential confusion or misuse of gas equipment with liquid equipment or visa versa.

- | |
|--|
|  WARNING |
| Materials of construction are chosen based on their chemical compatibility (or inertness) for general purposes. For exposure to specific environments, check with chemical compatibility charts before installing. |
- | |
|--|
|  WARNING |
| Sensors have been designed to account for loads to internal pressures in accordance with ASME codes. It is the responsibility of the user to access and account for other externally applied loads due to earthquakes, pipe movement and other environmental conditions. |
- | |
|--|
|  WARNING |
| During vertical Sensor installation use appropriate equipment to ensure safety. |
- | |
|---|
|  WARNING |
| The user is responsible for the selection of bolting and gasket materials which will fall within the limits of the flange and its intended use and which are suitable for the service conditions. |
- | |
|---|
|  WARNING |
| Never attempt to loosen, remove, or disassemble process connection or instrument housing while contents are under pressure. |
- | |
|--|
|  WARNING |
| Remove all condensation from Sensor before installing into line. |

2.7 Certificates

Certificates are posted on the Internet and on the documentation CD-ROM shipped with the device.

See also

Technical data (Page 139)

Certificates on the Internet (<http://www.siemens.com/processinstrumentation/certificates>)

Description

3.1 FUT1010 features

Description

The SITRANS FUT1010 is a spool flowmeter that achieves highly accurate flow measurement owing to the WideBeam ultrasonic transit-time technology. With the permanent TransLoc™ mounting system, the transducers are mounted on the outside of the pipe, preventing contact with the medium. This means no cavities or clogging.

TransLoc™ Sensor Mounting System

With the introduction of the permanently mounted transducer system, TransLoc, Siemens has developed a highly accurate and highly reliable mounting solution for the hydrocarbon industry. Using TransLoc, the WideBeam transducers are permanently mounted onto the spool permitting flow calibration and subsequent use in applications that require custody transfer accuracy. In addition, TransLoc allows the easy inspection of the transducers without stopping the flow or shutting down the process.

Description

3.1 FUT1010 features

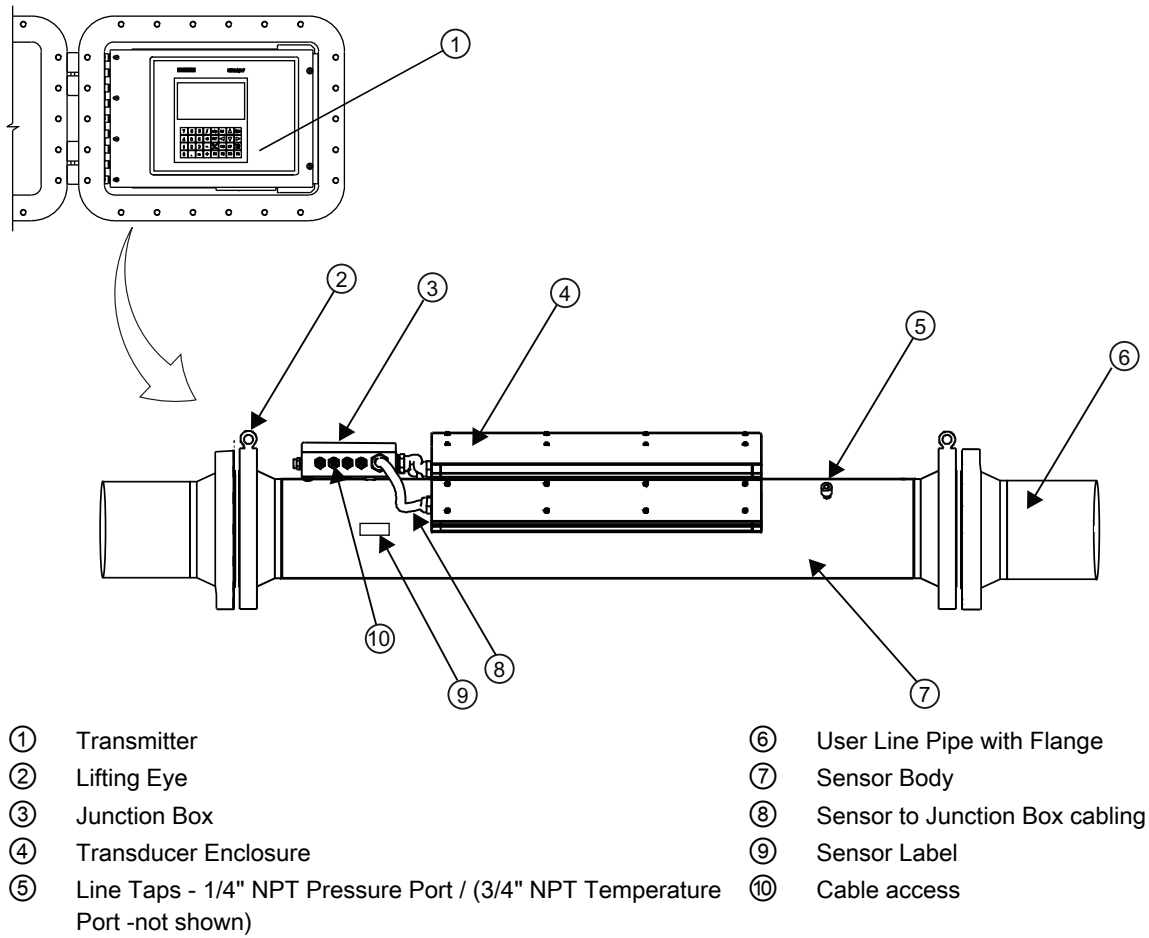
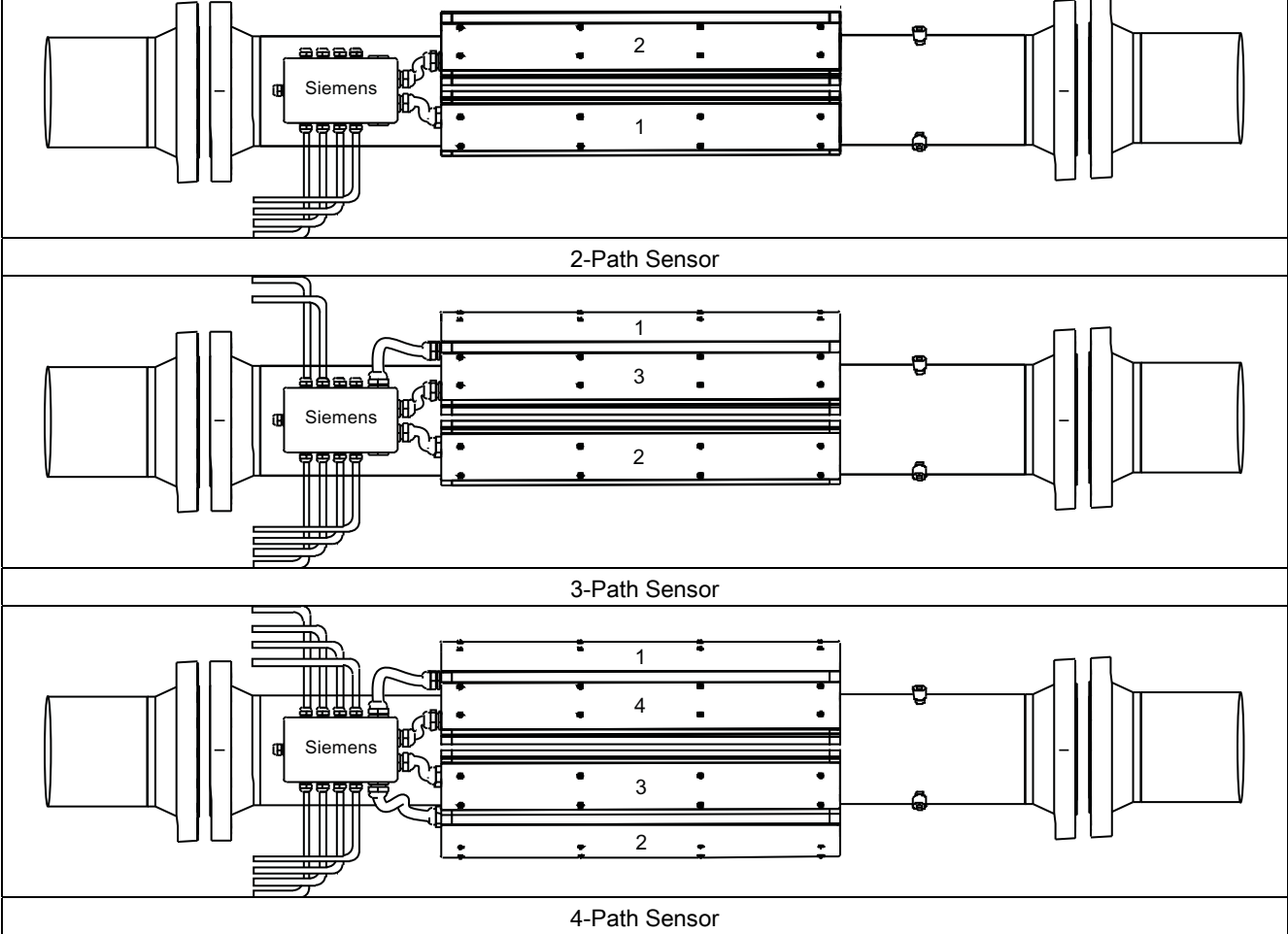

Figure 3-1 SITRANS FUT1010 Flowmeter

Wetted parts of the FUT1010 are available in Carbon Steel. The Sensor has a grade of encapsulation of IP65 NEMA 4X.

Versions

The FUT1010 flowmeter is available in 2-Path, 3-Path and 4-Path configurations.



3.2 NEMA 4X & NEMA 7 Transmitters

SITRANS FUT1010 Transmitters

The SITRANS FUT1010 NEMA 4X and NEMA 7 series transmitters are available in Dual Path and Multi-Path versions. The transmitters include a graphic display providing flow rate, diagnostics data and keypad interface to access on-screen software setup menus. Safety agency approved SITRANS FUT1010 series transmitters have hazardous area certification as indicated in the label example below.

SITRANS FUT1010 NEMA Transmitter Labels

The transmitter label is located on the right side panel of the unit. The illustration shows a typical label but labels vary depending upon model and installation location.



Figure 3-2 Typical Transmitter label

SITRANS FUT1010 Model Numbers

The SITRANS FUT1010 NEMA 4X model numbers:

- 2-Path - 7ME3631
- 3-Path - 7ME3633
- 4-Path - 7ME3633

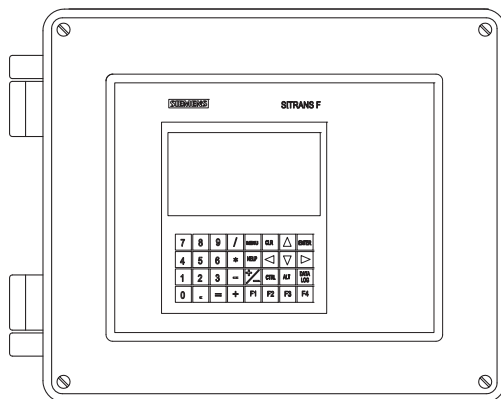

Figure 3-3 NEMA 4X Transmitter Case

Note

The NEMA 4X Multi-Path transmitter case is slightly larger.

The SITRANS FUT1010 NEMA 7 model numbers:

- 2-Path - 7ME3635
- 3-Path - 7ME3637
- 4-Path - 7ME3637

CAUTION

Consult local codes for permit needed to setup FUT1010 NEMA 7 units using the graphic display and local keypad. Keypad access and setup must be done with cover opened.

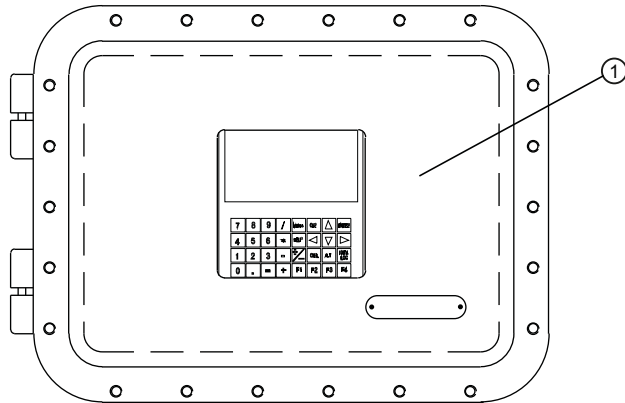

① Standard Case Enclosure

Figure 3-4 NEMA 7 Case Enclosure with graphic display and keypad.

3.3 Applications

Measurement of media

SITRANS FUT1010 gas flowmeters are designed for measurement of a variety of gases. The transmitters are multi-parameter devices offering accurate measurement of mass flow, volume flow, density, and temperature.

Typical Applications

The typical applications of the flowmeter are:

- Lost and unaccounted for (LAUF) analysis
- Allocation measurement
- Flow survey verification
- Production well testing
- Underground storage applications
- Gas fired power stations

Typical Industries Served

- Power Generation (Nuclear, Fossil, and Hydro)
- Chemical Processing

- Hydrocarbon Industries
- Hydrocarbon Transportation

3.4 Theory of Operation

The gas flow meter relies on the MultiPulse transit-time. Two Wide-Beam ultrasonic sensors per measuring path, alternating as transmitter and receiver, are used to interrogate the media flowing within the metering section. The resulting time of arrival for each direction of transmit (upstream and downstream) is then measured using a highly accurate and stable digital signal processing method.

Using this detection scheme, the flow meter is capable of resolving the relative transit-time difference (dT) to within ± 100 psec. Considering typical gas flow transit-time differences ranging from 1×10^4 to 1×10^6 psec, the flow meter is capable of providing an exceptional turn-down ratio. The flow meter also incorporates a correlation technique which enables the system to detect very high flow velocities with the same high degree of resolution. The ultrasonic sensors are designed with sufficient beam divergence characteristics to insure that the receive sensor will always have sufficient signal to maintain operation under conditions of high beam blowing associated with high flow velocities.

With accurate signal arrival time available, the flow meter can compute the raw flow velocity from the measured upstream and downstream transit times.

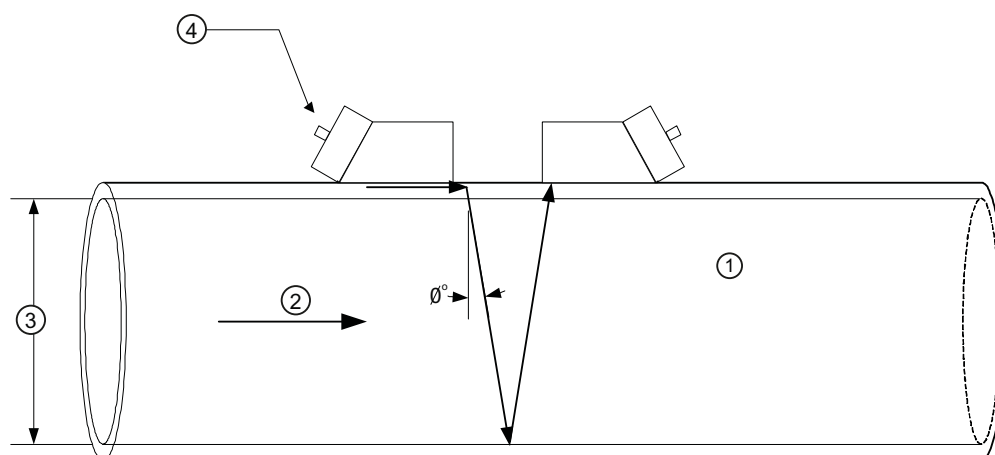

- ① Velocity of Sound
- ② Flow Vector
- ③ Pipe ID
- ④ Wide Beam Sensors

$$\theta^\circ = \sin^{-1} (V_{oS} / V_{\text{phase}})$$

$$T_L = 2 * ID / (V_{oS} * \cos \theta)$$

$$V_F = V_{\text{phase}} * DT / (2 * T_L)$$

Where:

V_{oS} = Velocity of sound in liquid

V_{phase} = Phase velocity of sensor

ID = Pipe inside diameter

T_L = Transit time in liquid

DT = Measured Transit-Time difference

V_F = Flow Velocity

Flow Profile Compensation

Although gas has a very low absolute viscosity, its kinematic viscosity can be greater than water. The flow meter continually computes the kinematic viscosity (centistokes) by dividing the fixed viscosity entry (refer to the Gas Parameters menu) by the computed gas density

The Reynolds number is then computed as follows:

$$Rn = \frac{645 * \text{Pipe ID} * V_F}{\text{Viscosity}}$$

Where:

viscosity = cS = cP/density

Pipe ID = inches

V_F = inches/sec

cS = kinematic viscosity

cP = absolute viscosity

The flow meter then uses this computation of Reynolds number to compensate the raw flow velocity for conditions of laminar or turbulent flow profile as defined by an internal Reynolds compensation table. The flow meter then converts the compensated flow velocity to volumetric flow rate.

$$\text{Rate} = V_F * \text{Comp}(Rn) * \text{Pipe area}$$

Standard Volume Compensation

Due to the high compressibility of gas, volumetric flow rate and total are commonly reported in standard volume (or normal) units. This requires the flow meter to dynamically compensate the actual measured volume to the volume anticipated at some specified reference pressure and temperature (referred to as base press and base temp in the Gas Parameters menu).

Note

The flow meter allows for a fixed entry of the gas compressibility factor or provides dynamic AGA8 compensation via an internal lookup table for standard volume compensation. If the gas composition varies significantly then an AGA8 volume compensating flow computer must be used where very high volume correction accuracy is required.

To compute this volume correction the flow meter requires the input of actual operating temperature and pressure. With this information the flow meter computes the standard flow rate as shown:

$$\text{Std. Rate} = Q_{\text{act}} * \frac{P_{\text{act}}}{P_{\text{base}}} * \frac{T_{\text{base}}}{T_{\text{act}}} * \frac{Z_{\text{base}}}{Z_{\text{act}}}$$

where: *Q* = Volumetric flow rate

P = Pressure (absolute)

T = Temperature (absolute)

Z = Compressibility

base = Base conditions (pressure and temperature)

act = Actual flowing condition (pressure and temperature)

Mass Flow Computation and Specific Gravity

The flow meter includes two different methods for computing the actual density of the gas being metered. The first method takes advantage of the transit-time measurement of the gas sound velocity (VOS or Vs) along with the measured temperature and the input of the gas specific heat ratio to determine the average specific gravity of the gas. This method is suitable for lower pressure applications where the gas composition varies dramatically.

The second method requires the input of an AGA8 based volume compensation table, which contains both the Z-factor and gas density for a specified range of pressure and temperature. This method is suitable for any pressure and temperature as long as the gas composition does not vary significantly, however a new table can be generated and installed to accommodate changes in gas composition. As with the standard volume compensation, a flow computer and gas chromatograph should be used where very high accuracy is required.

Flow meter Types

The meter automatically conditions Installation Menu choices to suit the selected meter type. The following paragraphs introduce the available flow meter types that include:

- 2-Path
- 3-Path
- 4-Path

2-Path

2-Path flow meters use two measurement channels to achieve a single output via a "virtual" third channel. The resultant data is the average of the two channels. Only clamp-on or in-line transit-time operation is allowed. Benefits include highest available precision and enhanced immunity to distorted flow profile conditions.

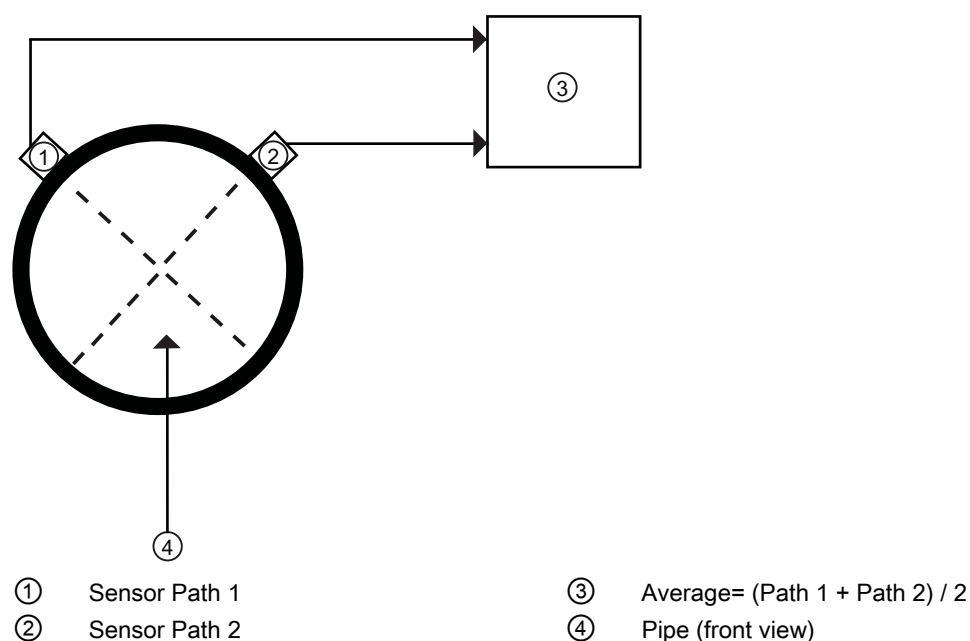

3-Path

3-Path flow meters use three measurement channels to achieve a single output via a "virtual" fourth channel. The resultant data is the average of the three channels.

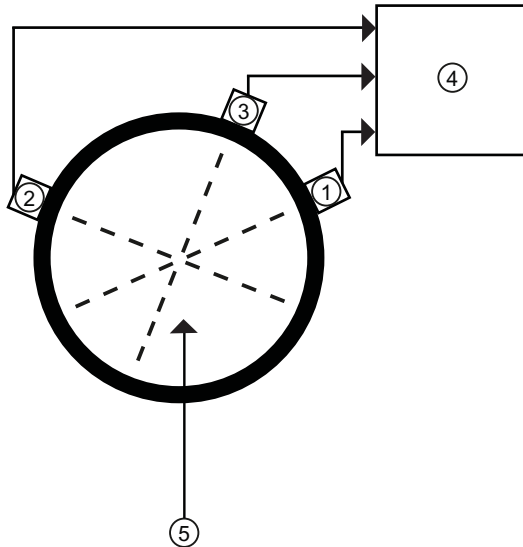

- ① Sensor Path 1
- ② Sensor Path 2
- ③ Sensor Path 3

- ④ Average= (Path 1 + Path 2 + Path 3) / 3
- ⑤ Pipe (front view)

4-Path

4-Path flow meters use four measurement channels to achieve a single output via a "virtual" fifth channel. The resultant data is the average of the four channels.

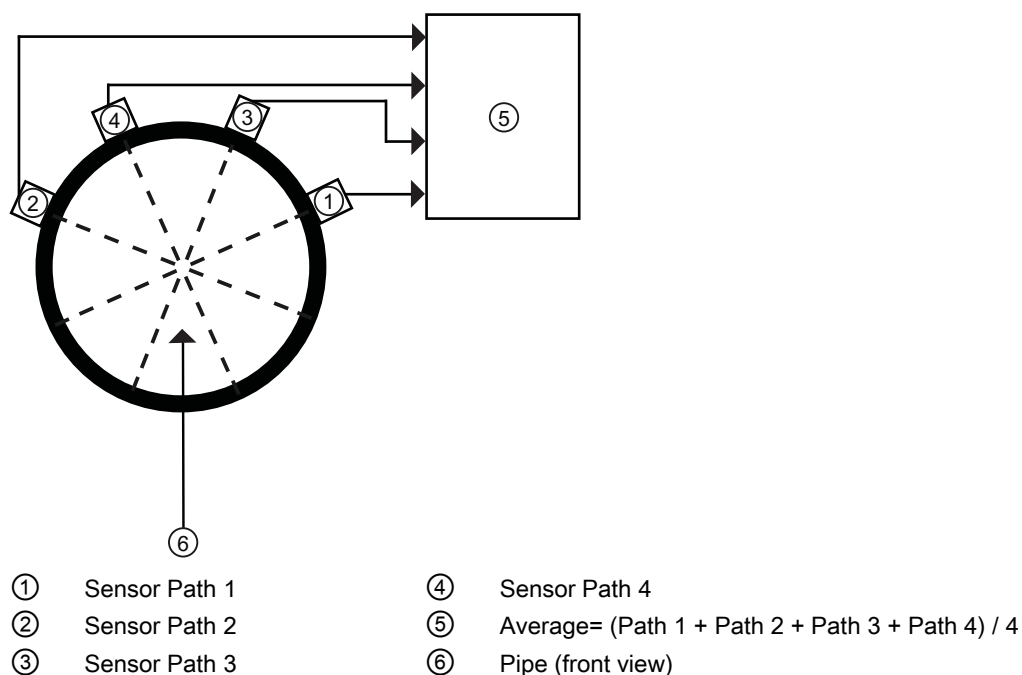

Wide Beam Transmission

As shown in the figure below, an ultrasonic sensor induces an axial sonic beam within the wall of the pipe. These vibrations spread along the pipe wall and then enter the gas in the form of a Wide Beam wave front traveling at an angle to the main pipe axis. The wide beam "rains" over the receiving sensor. The wide coverage of the receiver is necessary because the angle of the sonic beam is related to the gas sonic propagation velocity by Snell's Law.

$$\text{Beam Angle} = \text{Arc Sine} \left(\frac{\text{Gas Sonic Propagation Velocity}}{\text{Transducer Phase Velocity}} \right)$$

According to this formula, it can be stated that as the gas sonic propagation velocity changes so will the angle between the sonic beam and the flow stream.

Therefore, a significant gas sonic velocity shift could deflect a "narrow" beam transmission away from the receiving sensor entirely. The upstream vs. downstream transit-time difference will also be affected by the changing (or refracting) beam angle. This makes it necessary for TransLoc systems to continuously compute this angle, since it is subject to varying degrees of refraction. The flow meter derives the angle by knowing the fixed position of the sensors, the dimensions of the pipe and the measured transit-time. Therefore, the flow meter computes the beam angle relative to the axis of the pipe.

Flow Calibration Factor

Normally, the flow stream is in line with the axis of the pipe. On this basis, the calibration factor of a clamp-on ultrasonic flow meter is proportional to the cosine of the beam angle relative to the pipe axis. However, this reveals that if the angle of flow stream is not in line with the pipe axis, the flow calibration factor could be compromised. This most often occurs when the sensor mounting location is within close proximity of a bend or other pipe obstruction. This is why it is recommended that, whenever possible, mount sensors on the longest available straight run of pipe and also use Reflect Mode mounting (as shown below).

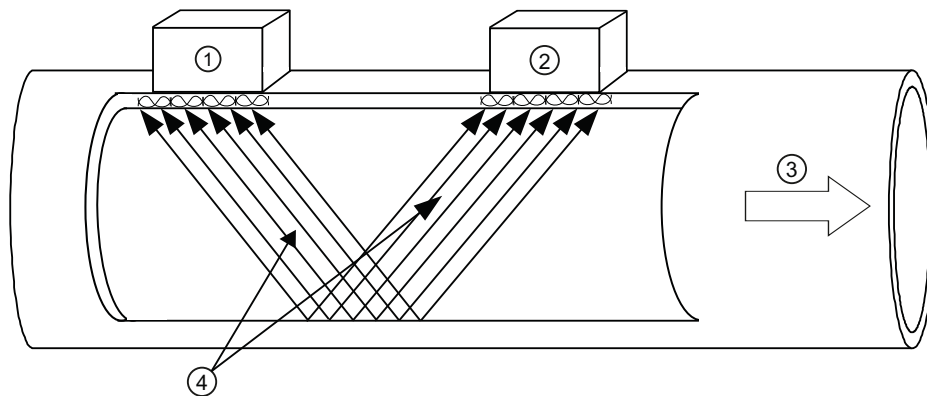

- ① Upstream Sensor
- ② Downstream Sensor
- ③ Flow Direction
- ④ Wide Beam transmissions exchanged between the Upstream and Downstream sensors

Reflect mounting automatically corrects for non-axial flow or cross flow conditions. When the exchange of sonic signals occurs by reflection off the far pipe wall as shown above, the average beam versus stream angle will be equivalent to that of an axial flow stream.

Installing/mounting

4.1 Determining a location

 WARNING
Electrical Shock Hazard Hazardous Voltage. May cause death or serious personal injury. Disconnect power before working on this product.

Upstream / Downstream

- Avoid long drop lines downstream from the sensor to prevent the meter pipe from draining.
- Avoid installing the sensor upstream of a free discharge in a drop line where possible.

Location in the system

The optimum location in the system depends on the application.

4.2 Use according to specifications

"Use according to specifications" covers:

- Use within technical limits.
- Consideration of gas specifications and references.
- Consideration of specifications as to installation, commissioning and maintenance.
- Operating pressure and temperature must be within the limits indicated on the product label.
- Flow and density must be within the specified limits

Do NOT:

- Use the flowmeter as elastic equalization in pipe systems to compensate for e.g. pipe displacement, pipe vibration, expansion, etc.
- Use the flowmeter as footboard for installation purposes.

4.3 Application Guidelines

- Use the flowmeter as support of external loads like pipes, etc.
- Change the flowmeter in any way. For e.g. decomposition of material in connection with processing, welding and use of accessories and spare parts not approved by Siemens Flow Instruments.

Note

If the flowmeter is not used according to the specifications, the manufacturer cannot be held responsible for any resulting damage.

4.3 Application Guidelines

Basic Requirements

- Determine pipe material and dimensions.
- Select a location with the longest straight run of pipe.
- Identify upstream piping configuration (elbow, reducer, etc.).
- Avoid pressure reduction components upstream.

Note

Flowmeter Application Data menu [Pipe Configuration] parameter is preset for [Fully Developed] flow.

Additional Requirements for Gas Applications

- Pipe must be fully pressurized during set-up to achieve proper operation.

4.4 Mounting the Transmitter

 WARNING
Hazardous Voltage
May cause death or serious personal injury. Disconnect power before working on this product.

Wall Mounting

The transmitter can be mounted on any wall surface including wood, metal or concrete. Use the appropriate bolts and screws as needed for your mounting application and adhere to local codes. (See figure below for mounting bracket locations.)

Pipe Mounting

For installation on 2-inch standpipe use Pipe Mount Kit CQO:1012NMB-1 (optional - see catalog). See figure below.

Note

Pipe mounting kit CQO:1012NMB-1 is not available for NEMA 7 enclosures.

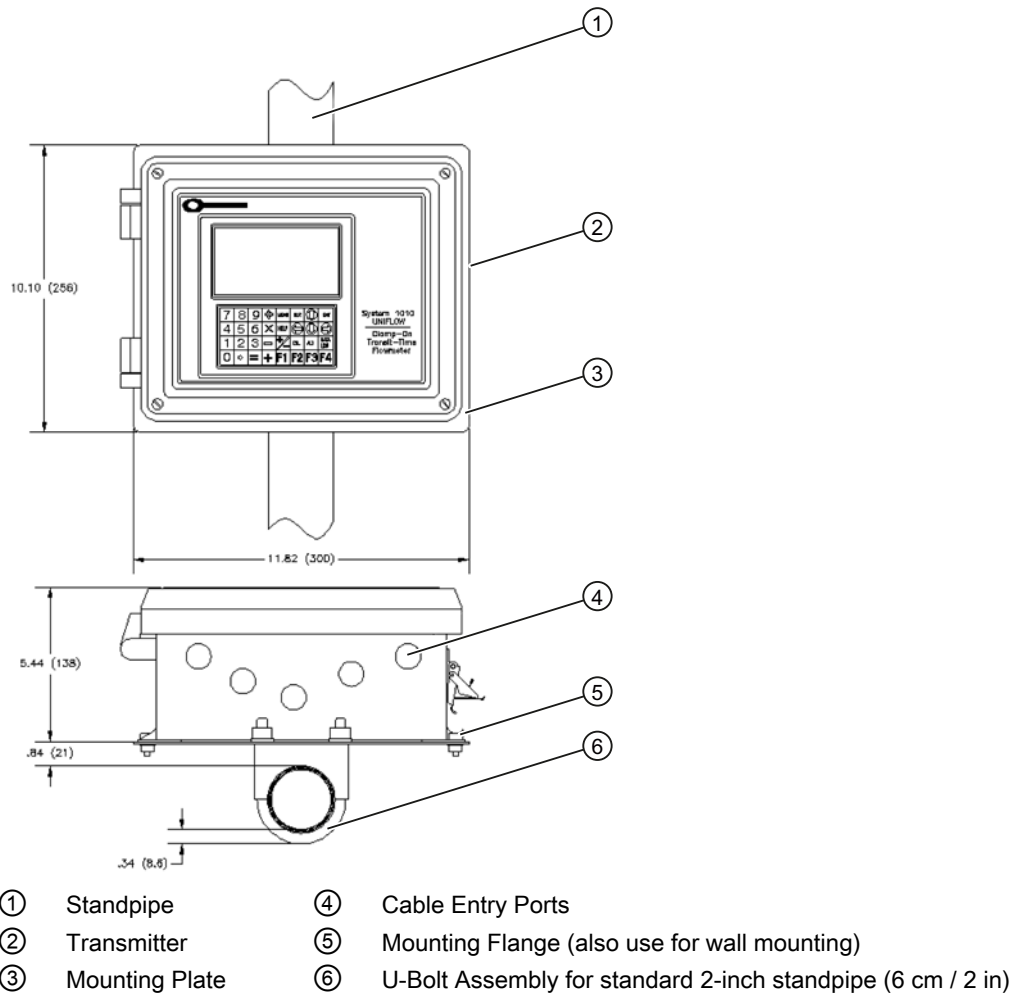



Figure 4-1 Pipe Mounting and Mounting Locations for Transmitter

Note

Use conduit fittings or cable glands on all cables.

 CAUTION
Install weather tight seals at all unused holes using proper cable conduit and close additional holes to IP65 standards.

4.5 Sensor Label Information

Sensor Label Markings

All Sensors are supplied with a metallic nameplate attached directly to the surface of the Sensor. The nameplate displays information regarding the operating limits of the Sensor as well as dimensional and other information required to insure the proper application and operation of the flowmeter. The information included in the Sensor nameplate is listed below:

- SIEMENS (Manufacturer of this flowmeter)
- METER BODY MODEL and SERIAL # (Code contains Sensor material, size and flange class)
- FLOWMETER P/N and SERIAL # (Indicates the specific transmitter electronics configured for this Sensor)
- TRANSDUCER P/N (Indicates part number of the transducers installed in this Sensor)
- DOM (Date of Manufacture MM/DD/YY)
- METER SIZE / CL (Meter size with ANSI or DIN flange class rating)
- I.D. (Internal Diameter of Sensor)
- WEIGHT (Weight of Sensor indicated in either Lbs or Kg)
- MAT BODY/FLANGE (Material of Sensor and flanges)
- BODY DESIGN CODE (Design code to which Sensor is fabricated)
- FLANGE DESIGN CODE (Design code to which flowmeter flanges are fabricated)
- Qmin / Qmax (Minimum and maximum actual flow that can be measured within AGA8 accuracy guidelines)
- Min OP (minimum operating pressure required for accurate flow measurement)
- MAOP (maximum allowable operating pressure of Sensor)
- OP TEMP (Operating temperature range of Sensor, including transducers)
- STORAGE TEMP (Recommended storage temperature of Sensor)
- HYDROSTATIC TEST PRESSURE (DOT MM/DD/YY)

 WARNING
HOT SURFACE - External spool temperature can exceed 93°C (200°F).

WARNING
Exceeding rated pressure identified as MAOP may cause Sensor failure.

<p>FUT 1010 Pressure Equipment Directive 97/23/EC</p> <p>Volumetric-Mass Flowmeter System</p> <div style="border: 1px solid black; padding: 5px; margin-top: 10px;"> <p>Hazardous information here. May vary depending on model purchased.</p> </div> <p style="font-size: small; margin-top: 10px;">Install per Siemens Dwg. A5E02716838A</p>	<table style="width: 100%; border-collapse: collapse;"> <tr><td style="border-bottom: 1px solid black;">SYSTEM P/N</td></tr> <tr><td style="border-bottom: 1px solid black;">SENSOR P/N</td></tr> <tr><td style="border-bottom: 1px solid black;">S/N</td></tr> <tr><td style="border-bottom: 1px solid black;">TRANSMITTER P/N</td></tr> <tr><td style="border-bottom: 1px solid black;">S/N</td></tr> <tr><td style="border-bottom: 1px solid black;">TRANSDUCER P/N</td></tr> <tr><td style="border-bottom: 1px solid black;">DOM</td></tr> </table>	SYSTEM P/N	SENSOR P/N	S/N	TRANSMITTER P/N	S/N	TRANSDUCER P/N	DOM	<table style="width: 100%; border-collapse: collapse;"> <tr><td colspan="2" style="text-align: right;">Siemens Industry, Inc</td></tr> <tr><td colspan="2" style="text-align: right; font-size: small;">Industry Automation Spring House, PA USA</td></tr> <tr><td style="border-bottom: 1px solid black;">METER SIZE / CL</td><td style="border-bottom: 1px solid black;"></td></tr> <tr><td style="border-bottom: 1px solid black;">I.D.</td><td style="border-bottom: 1px solid black;"></td></tr> <tr><td style="border-bottom: 1px solid black;">WEIGHT</td><td style="border-bottom: 1px solid black;"></td></tr> <tr><td style="border-bottom: 1px solid black;">MAT BODY/FLANGE</td><td style="border-bottom: 1px solid black;"></td></tr> <tr><td style="border-bottom: 1px solid black;">BODY DESIGN CODE</td><td style="border-bottom: 1px solid black;"></td></tr> <tr><td style="border-bottom: 1px solid black;">FLANGE DESIGN CODE</td><td style="border-bottom: 1px solid black;"></td></tr> <tr><td style="border-bottom: 1px solid black;">Qmin/Qmax</td><td style="border-bottom: 1px solid black;"></td></tr> <tr><td style="border-bottom: 1px solid black;">Min OP / MAOP</td><td style="border-bottom: 1px solid black;"></td></tr> <tr><td style="border-bottom: 1px solid black;">OP TEMP</td><td style="border-bottom: 1px solid black;"></td></tr> <tr><td style="border-bottom: 1px solid black;">STORAGE TEMP</td><td style="border-bottom: 1px solid black;"></td></tr> <tr><td style="border-bottom: 1px solid black;">DOT</td><td style="border-bottom: 1px solid black;"></td></tr> <tr><td style="border-bottom: 1px solid black;">TEST PRESSURE(BAR)</td><td style="border-bottom: 1px solid black;"></td></tr> </table> <p style="text-align: right; font-size: small; margin-top: 5px;">IP65 / NEMA 4X A5E02639002 Rev. 01</p>	Siemens Industry, Inc		Industry Automation Spring House, PA USA		METER SIZE / CL		I.D.		WEIGHT		MAT BODY/FLANGE		BODY DESIGN CODE		FLANGE DESIGN CODE		Qmin/Qmax		Min OP / MAOP		OP TEMP		STORAGE TEMP		DOT		TEST PRESSURE(BAR)	
SYSTEM P/N																																					
SENSOR P/N																																					
S/N																																					
TRANSMITTER P/N																																					
S/N																																					
TRANSDUCER P/N																																					
DOM																																					
Siemens Industry, Inc																																					
Industry Automation Spring House, PA USA																																					
METER SIZE / CL																																					
I.D.																																					
WEIGHT																																					
MAT BODY/FLANGE																																					
BODY DESIGN CODE																																					
FLANGE DESIGN CODE																																					
Qmin/Qmax																																					
Min OP / MAOP																																					
OP TEMP																																					
STORAGE TEMP																																					
DOT																																					
TEST PRESSURE(BAR)																																					

Assembled in U.S.A

Figure 4-2 Sample Sensor Label

4.6 Sensor Installation Procedure

Pre-Installation Check List

All Sensors are assembled with the final transducers and are mated to the selected transmitter electronics prior to delivery. The transmitter is pre-programmed with the installation parameters specific to this Sensor, therefore the installer should verify that the transmitter serial number matches the transmitter serial number indicated on the Sensor nameplate.

Perform the following checklist before installing the Sensor into the line:

1. Verify that the line operating conditions (flow velocity, pressure, temperature range) and line MAOP are within the limits specified for the flowmeter.
2. Verify that the transmitter electronics is paired with the serial number listed on the Sensor nameplate.
3. Check the condition of any pressure taps or Thermowell ports that may be provided with the Sensor. Install block valves, Thermowell, or plugs as necessary.

WARNING
User is responsible for ensuring that all Sensor ports are properly sealed.

- 4. User must verify that fluid is compatible with construction of Sensor material.

 WARNING
It is the responsibility of the user to account for any potential confusion or misuse of gas equipment for liquid equipment or visa versa.

 WARNING
Materials of construction are chosen based on their chemical compatibility (or inertness) for general purposes. For exposure to specific environments, check with chemical compatibility charts before installing.

 WARNING
Sensors have been designed to account for loads to internal pressures in accordance with ASME codes. It is the responsibility of the user to access and account for other externally applied loads due to earthquakes, pipe movement and other environmental conditions.

- 5. It is the responsibility of the user to avoid excessive corrosion, erosion or chemical attack due to the use of incompatible fluids or severe conditions.

Installation Procedure

Sensor is supplied with flanges suitable for handling. Lifting device should be within 10 degrees of vertical of the axis of the lifting eye.

 WARNING
During vertical installation of the Sensor use appropriate equipment to ensure safety.

 WARNING
The user is responsible for the selection of bolting and gasket materials which will fall within the limits of the flange and its intended use and which are suitable for the service conditions.

 WARNING
Never attempt to loosen, remove, or disassemble process connection or instrument housing while contents are under pressure.

Each Sensor is labeled with a flow direction arrow indicating the direction of positive (POS) FLOW. Although the flowmeter allows bi-directional flow, this arrow simply indicates the direction of positive flow so that the transducer cables can be installed without confusion. Install the Sensor into the lines with careful attention to this flow direction arrow and also the rotational orientation as described below.

⚠ WARNING

Remove all condensation from Sensor before installing into line.

Installation of the Sensor should be installed with the lifting eyes at or near the top of the Sensor (see figure below). Vertical installations have no restrictions since there are no cavities or Sensor ports to collect condensate and debris.

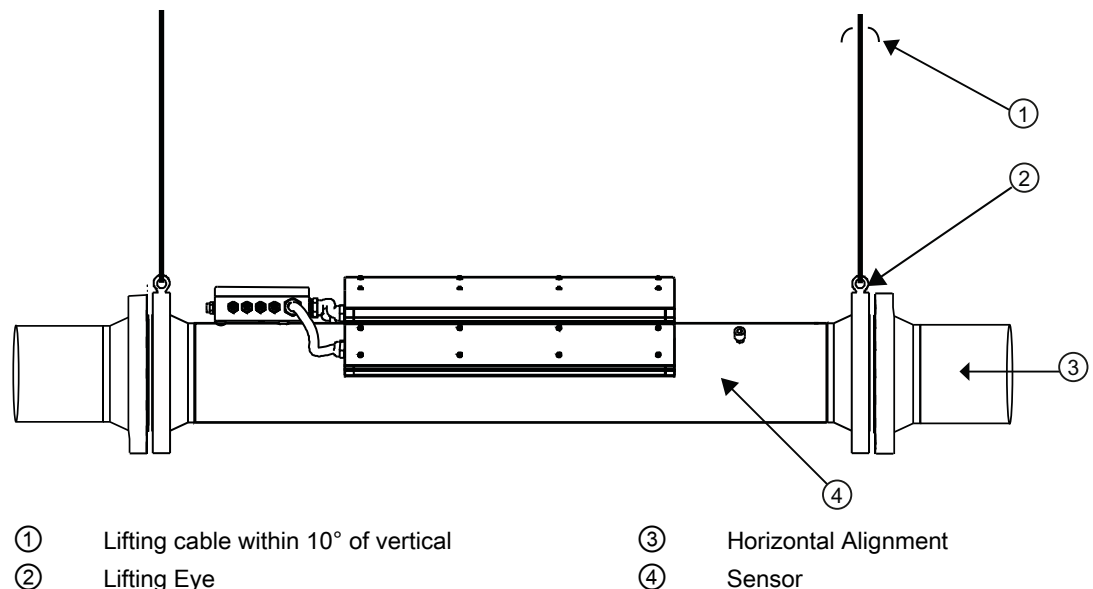

Figure 4-3 Sensor Installation

Always use flange bolts and nuts (not supplied unless requested) that are appropriate for the size and class of the Sensor flange. Flange Isolation kits (not supplied) should be utilized when indicated by the facility.

The following figure illustrates the hazardous location installation of the Sensor. It is shown connected to the upstream and downstream pipes with the optional flow conditioner installed and connected to the customer's pipe.

4.6 Sensor Installation Procedure

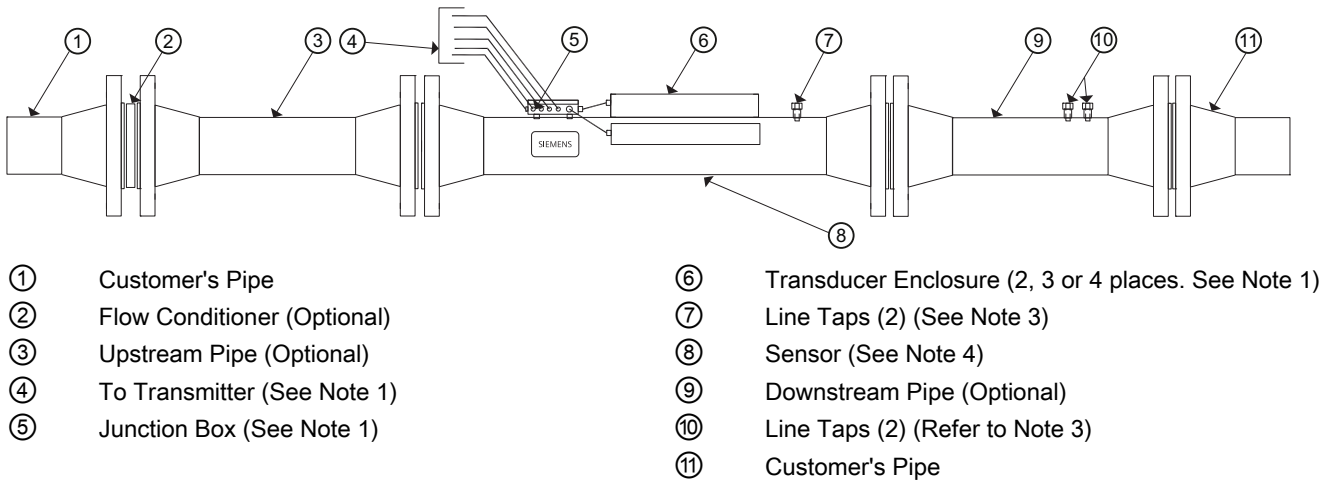

Figure 4-4 Hazardous Location Sensor Installation

Note 1

HazLoc qualified transducers type 7ME39501xxxx and 7ME39502xxxx are installed in the enclosures and prewired to the Junction Box. All connections to the transmitter are made in the Junction Box, which also houses the Resistive Temperature Device (RTD).

Note 2

See table below for the appropriate drawing defining the circuit connection restrictions dependent on transmitter type and hazardous area ratings.

Note 3

The spool meter body has two line taps for end user temperature, pressure and other sensors. Ensure that any devices used are appropriate for the area rating.

Note 4

Sensor Model numbers 7ME362... and 7ME363... can be used with any of the transmitter types indicated in the Hazardous Area Ratings table below. The area ratings shown define the permitted locations for sensor installation. Refer to the specific drawings for additional restrictions of the transmitter location area rating.

Note

Not all transmitter models are offered with this configuration.

Table 4- 1 Hazardous Area Ratings

Transmitter		Area Rating (see Note 4)		
Siemens Model No.	Legacy Model No.	ATEX Zone 0/1	ATEX Zone 2	FM/CSA Division 1 and 2
7ME3500...	1010N	1010-389	1010-391	1010-304
7ME3530...	1010MN, 1010N			
7ME3600...				
7ME3610...				
7ME3532...	1010WX	1010-464		1010-443
7ME3533...				
7ME3602...				
7ME3603...				
7ME3612...				
7ME3613...				
7ME3531...	1010X	1010-422	1010-423	1010-341
7ME3601...				
7ME3611...				

Connecting

5.1 Safety notes for connecting

Use in hazardous locations

 **WARNING**

Only qualified personnel may carry out work on the electrical connections.

Before opening the terminal box check that:

- No explosion hazard exists
- Local safety codes and policy requirements have been followed
- All connection leads are potential free

 **WARNING**

Explosion Hazard

"Flameproof enclosure" type of protection

Only open devices with type of protection "Flameproof enclosure" (FUT1010 NEMA 7) in hazardous areas when the power to the device is turned off, otherwise there is a risk of explosion.

 **WARNING**

Explosion Hazard

Hazardous areas

Observe the type examination certificates or the test certifications applicable in your country if you use transmitters as category 1/2 equipment.

 **WARNING**

Explosion Hazard

Intrinsically safe circuits

With intrinsically safe circuits, use only certified meters appropriate for the transmitter.

If a non-conforming supply unit is used, the "fail-safe" type of protection will no longer be effective and the approval certification will be invalid.

 WARNING
Explosion Hazard Laying of cables Cable for use in zone 1 and 2 must satisfy the requirements for having a proof voltage < AC 500 V applied between the conductor/ground, conductor/shield and shield/ground. Connect the devices that are operated in hazardous areas as per the stipulations applicable in the country of operation, e.g. for Ex "d" and "nA", permanent cables must be laid.

 WARNING
Explosion Hazard Devices with the common approval "Intrinsically safe" and "Flameproof" The following is applicable for devices with the common approval "Intrinsically safe" and "Flameproof" (Ex ia + Ex d): Before commissioning, make sure that the type of protection that is not suitable is permanently defaced on the nameplate to avoid improper use. If a non-conforming infeed is used, the "fail-safe" type of protection will no longer be effective.

 WARNING
Only commission the device after the device has been properly connected and, if required, closed.

5.2 Transmitter Wiring

5.2.1 Connecting Power

 DANGER
Electrical Shock Hazard Turn off main power before installing AC connections to the transmitter. Contact with exposed wiring may lead to fire, electric shock, or serious personal injury.

1. Open the transmitter top cover.
2. Unscrew the two power supply access cover fasteners and remove access cover.

3. Locate power supply connector J10. Using a flat blade screwdriver, remove plug P10 from connector J10. Set aside.

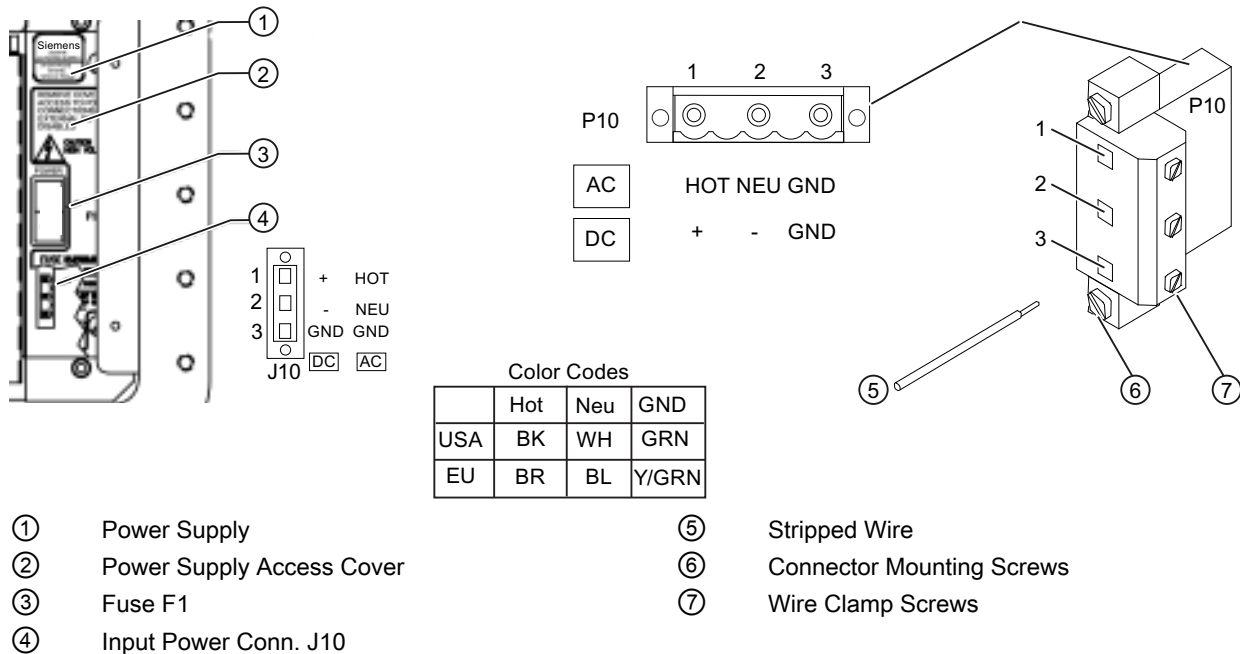

Figure 5-1 Input Power Plug (P10) Wiring

4. Pull the desired length of input power wires through a cable gland and into transmitter case before wiring connector.
5. As per local electric codes, wire input power connector P10 for AC or DC power depending on power supply provided.

Note

Dress cables and make sure cable length is not excessive as to impede proper replacement of access cover.

6. Insert wires into wire entry holes and secure by tightening wire clamp screws (see figure above).

Note

Power Supply connector wires should be stripped AWG 12 - 18 stranded wire or solid conductors.

7. Plug input power plug P10 into connector J10 and secure using two captive connector mounting screws.

8. Replace access cover. Make sure Keypad Enable switch is in the "Enable" position (see below).

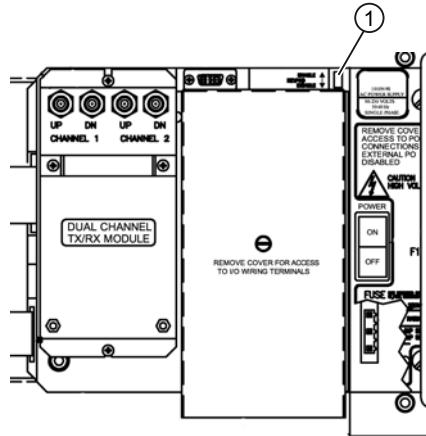

① Enable Switch

 CAUTION
Improper power connections will damage power supply.

9. Connect the power cables to the appropriate power source (100-250 VAC @ 50/60 Hz or 9-36 Vdc). Close top cover.

5.2.2 Connecting Sensor Cables to Transmitter

1. Open the transmitter top cover. Using a flat blade screwdriver, remove the Cable Strain Relief bracket.

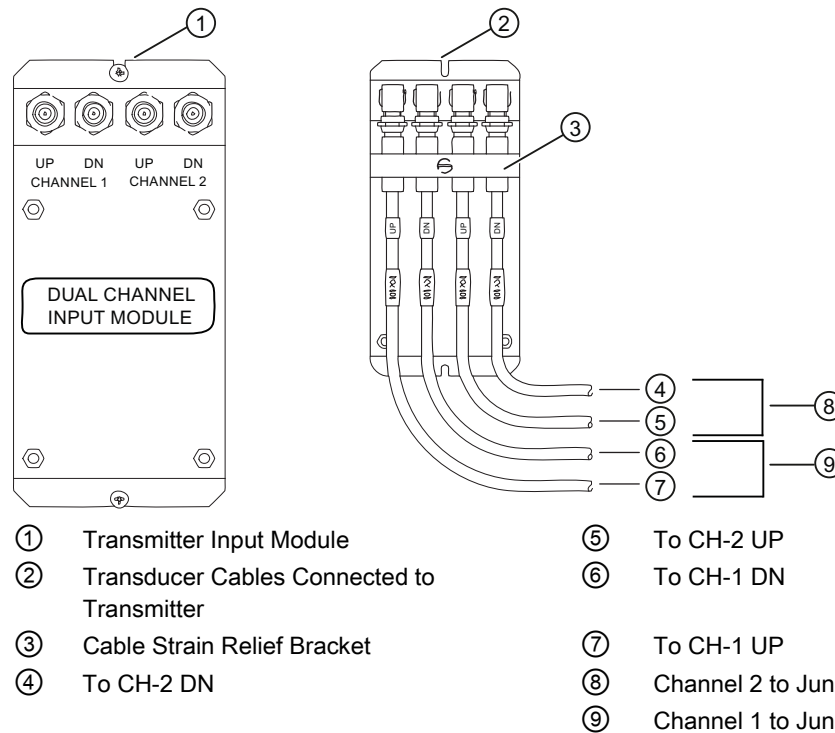

Figure 5-2 Sensor Cable Connections

2. Observing the upstream to downstream orientation, pull Sensor cables through transmitter cable glands.
3. Attach the Sensor cables to Channel 1 and Channel 2 UP and DN Input Module F-connectors. Repeat for additional paths as necessary.
4. Replace the Cable Strain Relief bracket. Close transmitter top cover.
5. If not installing a Temperature Sensor, proceed to Sensor Wiring.

5.2.3 Wiring Temperature Sensor to Transmitter

Wiring Temperature Sensor Board to Transmitter

⚠ WARNING
Electrical Shock Hazard
Set transmitter and instrumentation power to OFF when inserting or removing the Analog Input Module, or when making connections to TB1, TB2, TB3 and TB4.

1. Disconnect power to the transmitter.
2. Open transmitter top cover by releasing the cover latch.
3. Loosen the captive screw securing the Access Cover and remove Access Cover.
4. Using a flat-blade screwdriver, remove four screws securing the I/O Module board. Remove board and set it aside.

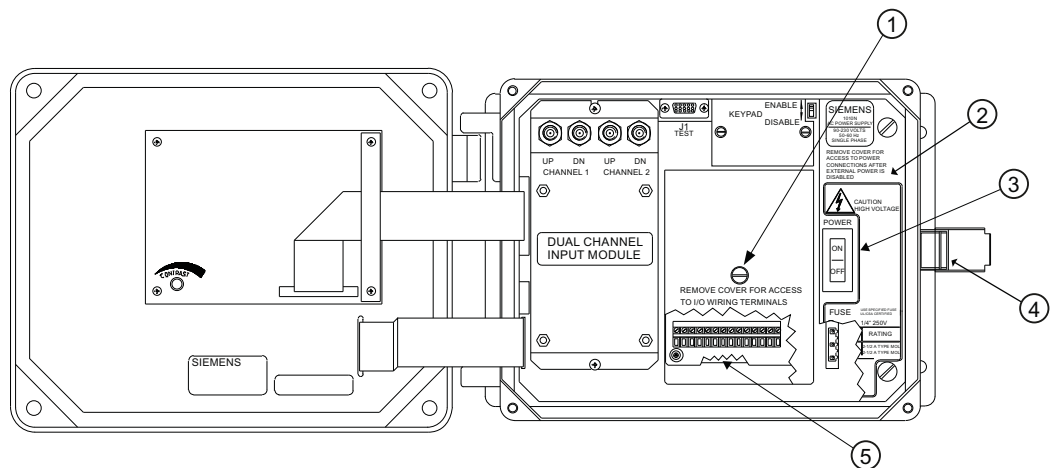

- | | |
|----------------------|---------------------------------|
| ① Access Cover Screw | ④ Latch |
| ② Flowmeter | ⑤ Access to Analog Input Module |
| ③ Power Switch | |

Figure 5-3 Analog Input Module Access

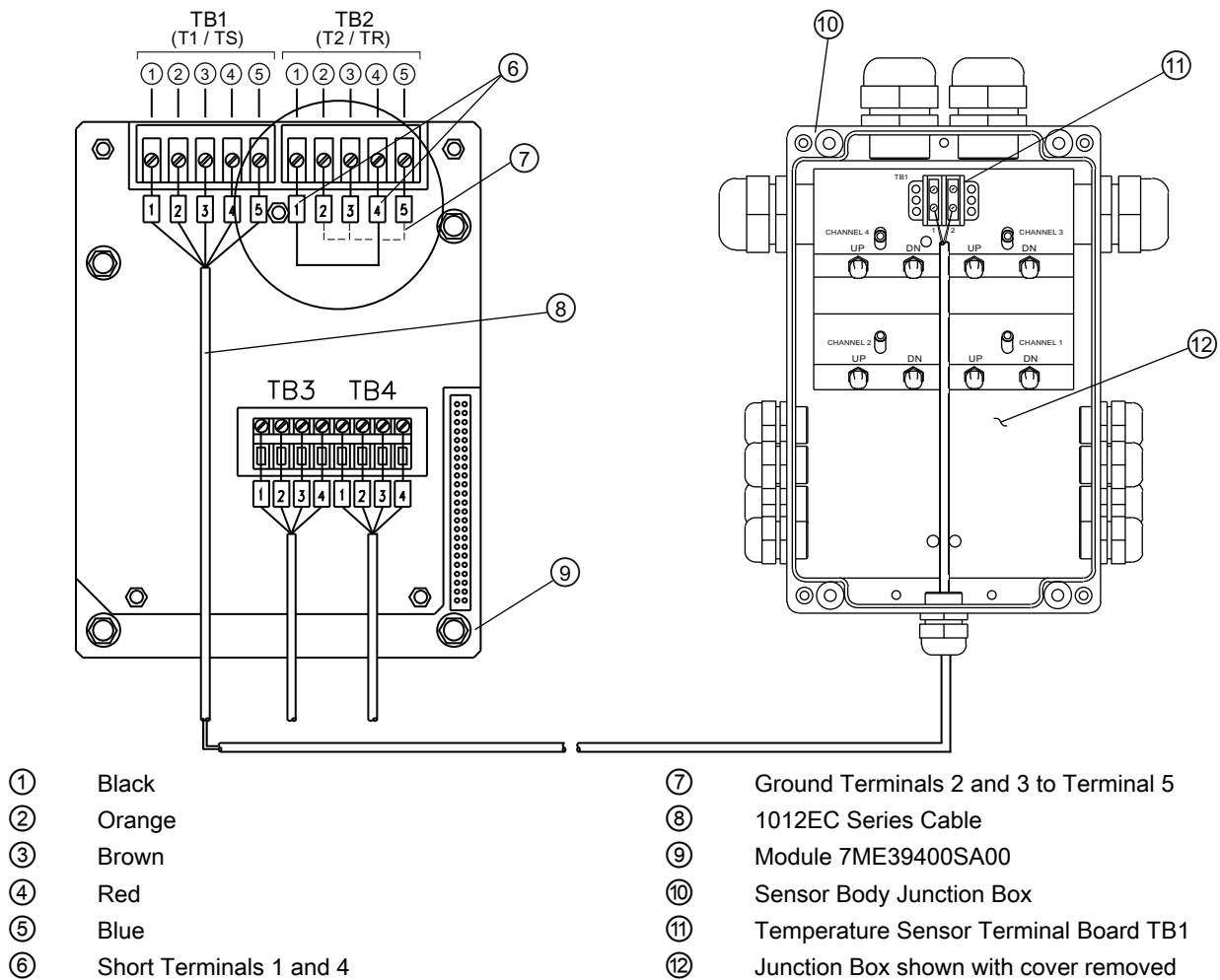

Figure 5-4 Temperature Sensor to Junction Box Wiring

Wiring Temperature Sensor Board

1. Using a flat-blade screwdriver, loosen Terminal Block TB1 and TB2 screws.
2. Wire the RTD 1012EC temperature cable as shown in the table below:

1012EC Series Cable	Terminal TB1
Wire #1 (Black)	To TB1--1
Wire #2 (Orange)	To TB1--2
Wire #3 (Brown)	To TB1--3
Wire #4 (Red)	To TB1--4
Wire #5 GND/SHLD (Blue)	To TB1--5

3. Complete the temperature sensor current loop by shorting together terminals 1 and 4 of the unused TB2 temperature sensor terminal block.
4. Ground the voltage sensing leads (terminals 2 and 3 of TB2) by connecting them both to terminal 5.

5. Tighten all TB1 and TB2 terminal block screws.
6. Replace I/O Board and secure with four screws paying careful attention to pin alignment.
7. Replace Access Cover, tighten captive screw and close transmitter case.

Note

TB3 and TB4 are also active analog inputs. See wiring table below.

Table 5- 1 TB3 and TB4 Wiring

Pin	TB3 Function	TB4 Function	Use	Description	Behaviour	Load	Wiring
1	AUX. 1 IN	AUX. 3 IN	lin1 Input	Analog current input referenced to meter ground.	4 to 20mA	200Ω	1000 ft. Max w/o factory approval
2	AUX. 1 COM	AUX. 3 COM	lin1 Common				
3	AUX. 2 IN	AUX. 4 IN	lin2 Input				
4	AUX. 2 COM	AUX. 4 COM	lin2 Common				

Notes on Analog Input Modules

Dual Path Models

- All models use T1 to report temperature.
- The Analog Input of temperature takes priority over the built-in RTD (Resistive Thermal Device) measurement of temperature when provided.

5.3 Sensor Wiring

5.3.1 Connecting Sensor Cables to Sensor

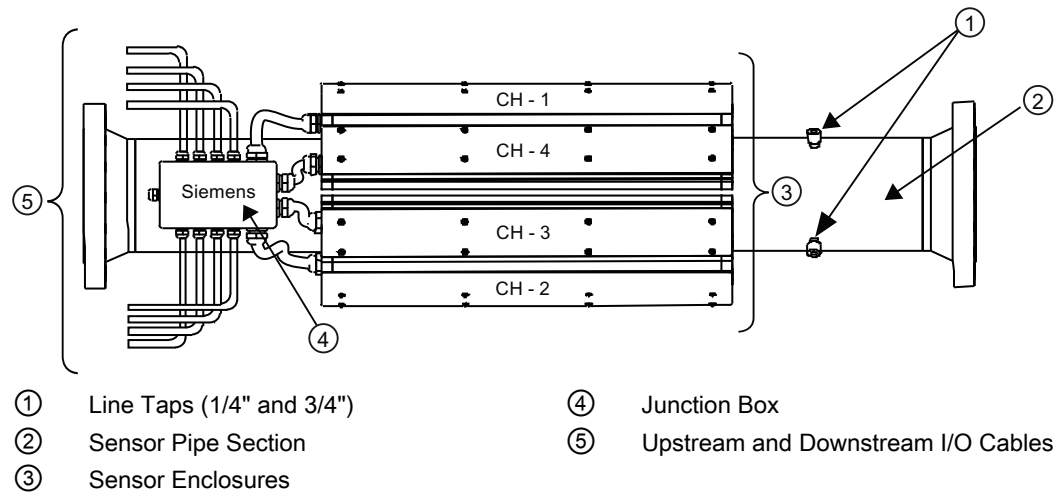
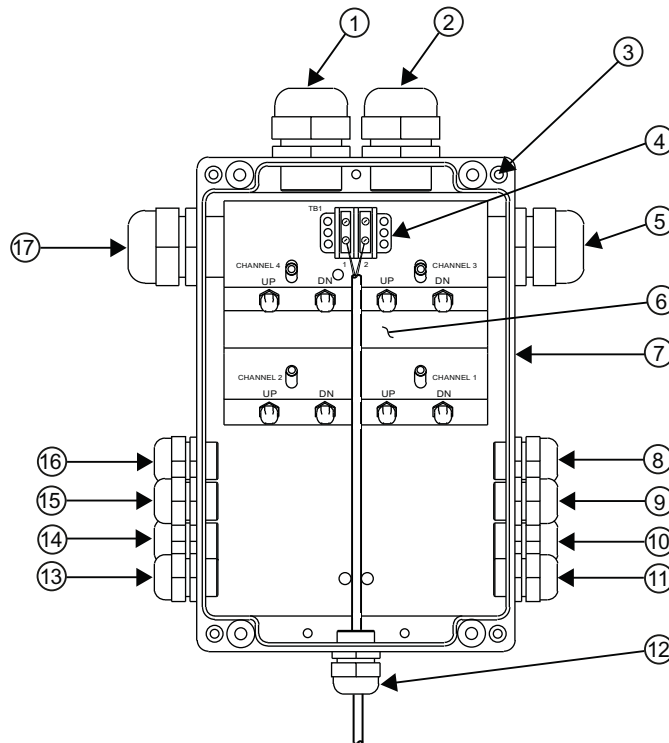

Figure 5-5 Sensor Overview

1. Remove four (4) #10 bolts securing Junction Box top cover. Remove cover and set aside bolts.



- | | |
|---|-------------------------------------|
| ① CH 4-Sensor to Junction Box Gland | ⑨ CH 4 - UP to Transmitter |
| ② CH 3-Sensor to Junction Box Gland | ⑩ CH 2 - DN to Transmitter |
| ③ Top Cover #10 bolts (4) | ⑪ CH 2 - UP to Transmitter |
| ④ Temperature Sensor Terminal Board TB1 | ⑫ Temperature Sensor Gland |
| ⑤ CH 2-Sensor to Junction Box Gland | ⑬ CH 1 - DN to Transmitter |
| ⑥ Transducer Channel F-Connectors | ⑭ CH 1 - UP to Transmitter |
| ⑦ Junction Box without top cover | ⑮ CH 3 - DN to Transmitter |
| ⑧ CH4 - DN to Transmitter | ⑯ CH 3 UP to Transmitter |
| | ⑰ CH 1-Sensor to Junction Box Gland |

Figure 5-6 Sensor Cable Installation

2. Observing the upstream to downstream orientation, pull Channel-1 and Channel-2 UP and DN Sensor cables into the corresponding CH-1 and CH-2 Junction Box glands.

CAUTION

When connecting sensor cables inside Junction Box cable bend radius should not exceed bend tighter than 8 cm (3 in.) or damage to cables may result.

3. Secure cables to CH-1 and CH-2 UP and DN F-connectors making sure the connection is finger tight.

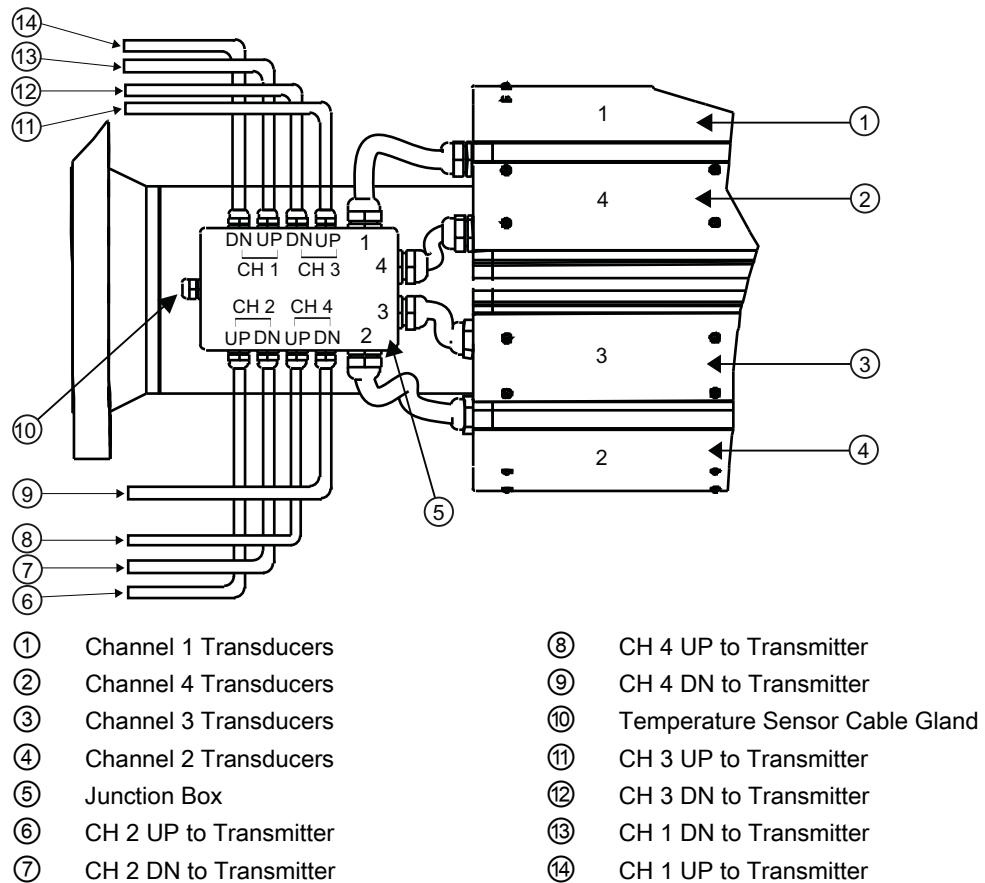

Figure 5-7 Sensor Interconnection Diagram

4. Repeat for additional paths, if necessary.

5.3.2 Wiring Temperature Cable to Sensor

1. Locate Temperature Sensor terminal block TB1 connection screws.
2. Insert Temperature Sensor cable from transmitter into Junction Box gland.

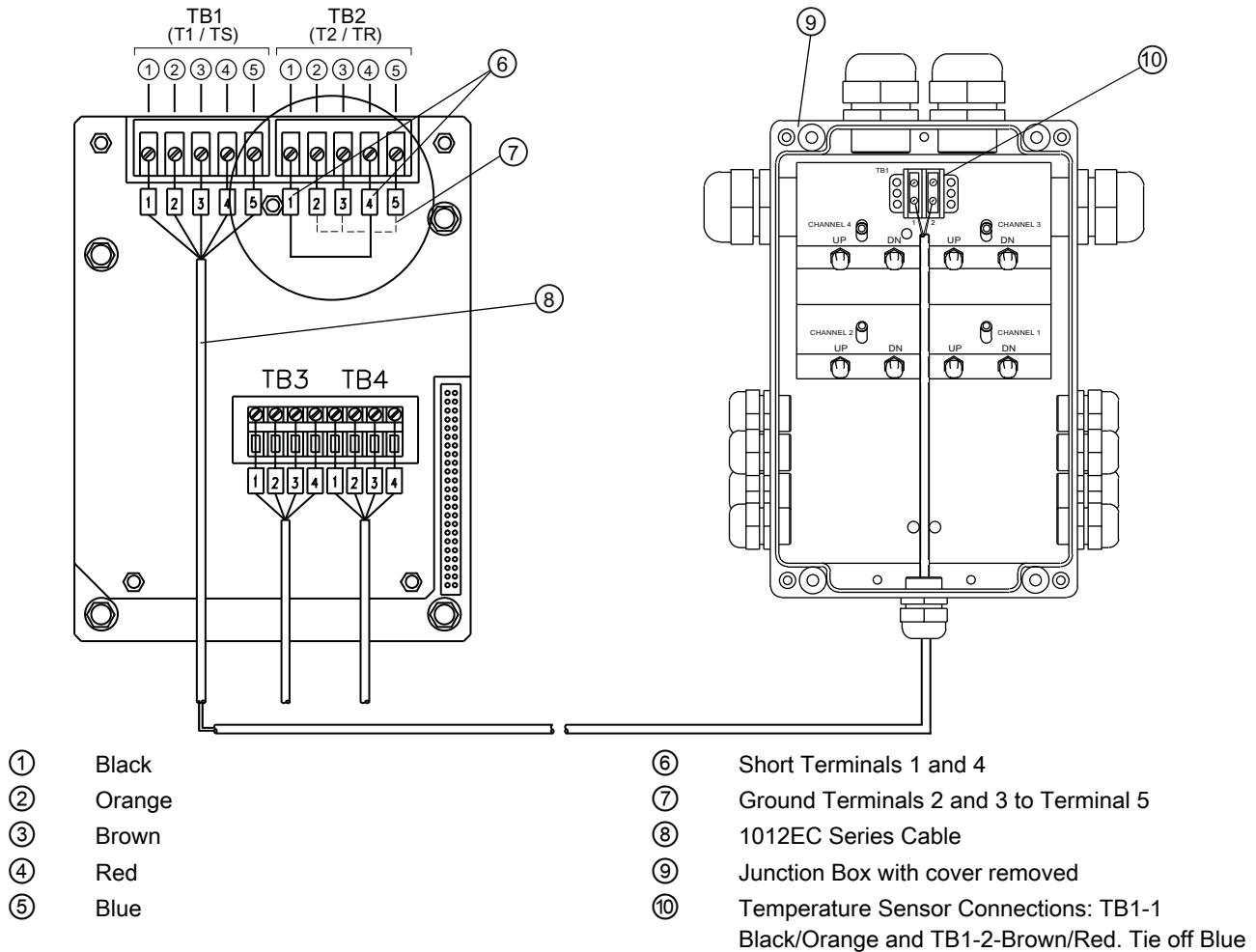

Figure 5-8 Temperature Sensor Board to Junction Box Wiring

3. Connect Temperature Sensor PCB wires to Junction Box Sensor terminal board as follows:
 - Insert Black and Orange wires into lug (supplied), crimp lug and connect lug to TB1-1.
 - Insert Brown and Red wires into lug (supplied), crimp lug and connect lug to TB1-2.
 - Tie off Blue wire.
 - Make sure all terminal block lug connections are hand-tight.
4. Replace Junction Box top cover.
5. Reinstall and hand-tighten four (4) Junction Box securing bolts. Using a torque wrench, torque each bolt to 6.8 to 8.1 Nm (5 to 6 ft-lbs).

Commissioning

6.1 General requirements

Before commissioning it must be checked that:

- The device has been installed and connected in accordance with the guidelines provided in chapter 4 "Installing/mounting (Page 33)" and 5 "Connecting (Page 43)"
- Device installed in hazardous location meets the requirements described in "Installation in hazardous location (Page 13)"

6.2 Commissioning

 WARNING
--

Electrical Shock Hazard

Certain parts inside the device carry dangerous high voltage. The transmitter must be grounded and the top cover closed before switching the device on.

 CAUTION
--

Confirm that power cables are connected to the appropriate power source (100-250 VAC @ 50/60 Hz or 9-36 Vdc).

1. Apply power.
2. Within 10 seconds of power-up the main display will become active and a typical Siemens graphic will appear briefly. The screen also identifies the software version of the unit as shown below.



① Software operating system version

Figure 6-1 Startup Screen

3. The transmitter is ready to report flow. Press <MENU> key twice to display flow.

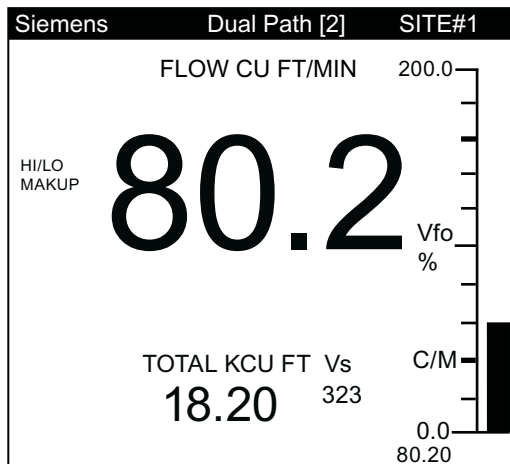

6.3 Navigating the Menu

Installation Menu Navigation

The Installation Menu Chart is a multi-level structure divided into three columns from left to right		
Level A - lists the major menu categories.		
Level B - lists the menu cells associated with Level A. You can enter data into Level B menu cells that display parameters in a column on the right-side of the screen.		
Level C - lists the Level B data		
Level A	Level B	Level C
	Recall Site Setup	Pump 1 Pump 2
	Channel Enable	
	Create/name Site	
	Site Security	
	Delete Site Setup	
	Save/Rename Site	

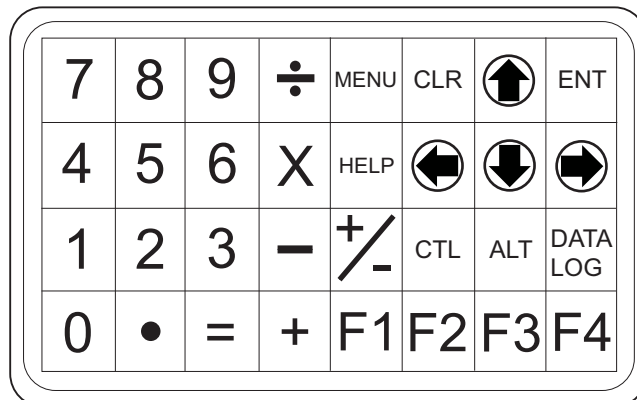

Figure 6-2 Keypad

Note

Use <Left Arrow> to return to previous menus.

Table 6- 1 Keypad Function Chart

Keys	Description
MENU	Press to activate the Installation Menu.
ENT	Store numeric data, select from option lists, etc.
Left / Right Arrows	Menu navigation keys move cursor.
Up / Down Arrows	Same as <Left> and <Right> arrows. Scrolls option lists and graphic display screen.
CLR	Erases data or selects list options.
Numbers 0 - 9	Use to type numeric data.
Decimal Point	Use for decimal points in numeric data.
Math Operators	4-function math operations in numeric entry cells.
"F" Keys 1, 2, and 3	Caution: System Reset Key (use during power up).
CTRL and ALT	Used as shift keys for alternative key functions.
DATALOG	Triggers immediate Datalogger report.
Plus and Minus [+ / -]	Changes the sign of numeric data.

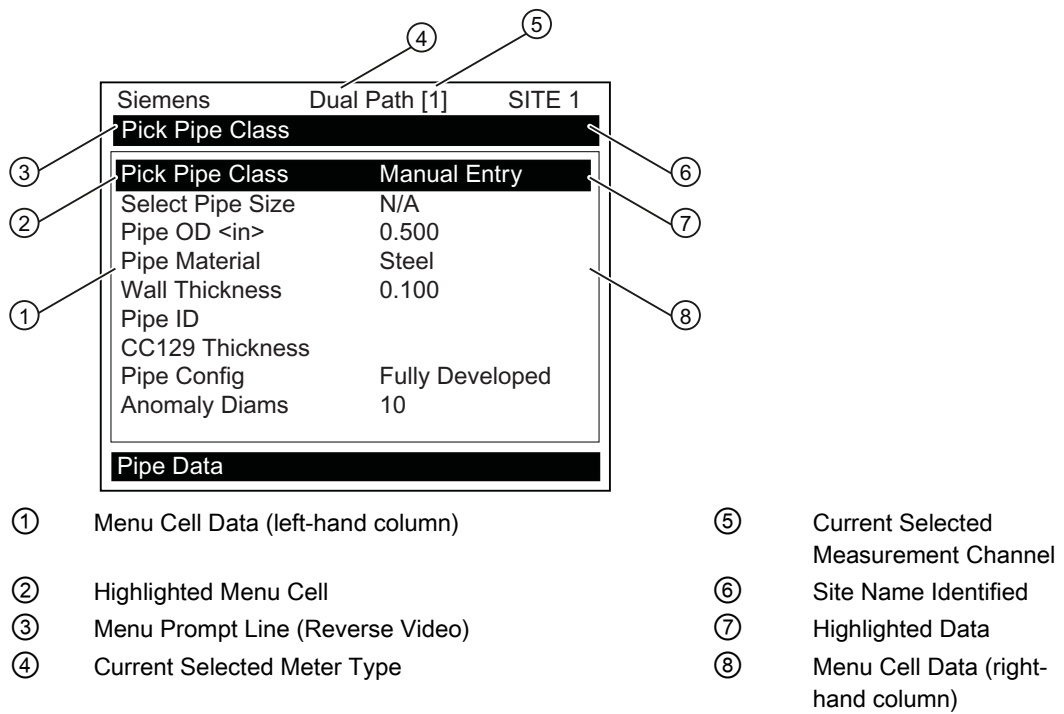

Figure 6-3 Typical Installation Menu Screen

6.4 Installation Menus

FUT1010 Installation Menu Chart

Level A	Level B	Level C	Level D (see manual)	Level E	Level F
Meter Type	Dual Path Flow	Chan/Path Setup	Recall Site Setup	Enter From List	
			Channel Enable	Enter From List	
			Create/Name Site	Enter From List	
			Site Security	On/Off	
			Delete Site	Enter/Clear Site Name	
			Save/Rename Site	Enter From List	
		Pipe Data	Pick Pipe Class	Enter From List	
			Select Pipe Size	Enter From List	
			Pipe OD (in)	Numeric Entry	
			Pipe Material	Enter From List	
			Wall Thickness	Numeric Entry	
			Pipe ID (in)	Numeric Entry	
			CC129Thickness	Numeric Entry	
			Pipe Config	Enter From List	
			Anomaly Diamss	Numeric Entry	
			ThermExpCoef 1/F	Numeric Entry	
			Mod of Elast PSI	Numeric Entry	
		Gas Parameters	Base Temperature F	Numeric Entry	
			Base Pres. PSIA	Numeric Entry	
			Spec. Heat Ratio	Numeric Entry	
			Viscosity <cP>	Numeric Entry.	
			Fixed MW g/mole	Numeric Entry	
			Estimated Vs F/S	Numeric Entry	
			Fixed Pres. PSIA	Numeric Entry	
			Z Base	Numeric Entry	
			Z Actual	Numeric Entry	
			AGA8 Comp.	No/Yes	
		Install Xdcr	Install Path	Enter From List	
			Transducer Model	Enter From List	
			Transducer Size	Enter From List	
			Xdcr Mount Mode	Enter From List	
			Spacing Offset	Enter From List	
			Number Index	View Only	
			Spacing Method	View Only	
			Ltn Value	View Only	

6.4 Installation Menus

Level A	Level B	Level C	Level D (see manual)	Level E	Level F
			Install Complete	No / Install	Select Install
			Zero Flow Adjust	Enter From List	
		Operation Adjust	Damping Control	Time Average / SmartSlew	
			Deadband Control	Numeric Entry	
			Memory/Fault Set	Fault/Memory	
			Memory Delay (s)	N/A	
		Flow Total Units	Flow Vol. Units	Enter From List	
			Std Vol Corr	No/Yes	
			Flow Time Units	Enter From List	
			Flow Disp. Range	Enter From List	
			Flow Disp. Scale	Enter From List	
			Total Vol. Units	Enter From List	
			Std Vol Corr	No/Yes	
			Totalizer Scale	Enter From List	
			Total Resolution	Enter From List	
			Totalizer Mode	Enter From List	
			Batch/Sample Tot	Numeric Entry	
		Span/Set/Cal	Span Data	Enter From List	
			Set Alarm Levels	Enter From List	
			Calib. Flowrate	Intrinsic	
				Kc	
				MultiPoint	
			Calib. Table 1	Index Variable 1	Enter From List
				Calib. Table 1	New Point
				Table Active 1	No/Yes-
				Clear Table 1	No/Yes
			Calib. Table 2	Same as Table 1	
			Calib. Table 3	Same as Table 1	
			Display Setup	Select Data	Enter From List
				Data Display	Enter From List
				Time Base	Enter From List
				StripChart Clear	No/Yes
			Logger Setup	Logger Mode	Enter From List
				Logger Data	Enter From List
				Logger Interval	Enter From List
				Logger Events	Enter From List
				Display Logger	Enter From List
			I/O Data Control	Analog Out Setup	Enter From List
				Relay Setup	Relay 1,2,3,4
				Analog Inp Setup	Enter From List

Level A	Level B	Level C	Level D (see manual)	Level E	Level F
			Diagnostic Data	Path Select	1,2, 1 & 2
				Path Enable	No/Yes
				Flow Data	Enter From List
				Application Info	Enter From List
				Gas Data	Enter From List
				Site Setup Data	Enter From List
				Test Facilities	Enter From List
				Print Site Setup	No/Yes
				Site Created:	View Only
Meter Facilities	Preferred Units	English			
		Metric			
	Table Setups	Pipe Table	Create/Edit Pipe	Enter From List	
			Delete Pipe	Enter From List	
		Transducer Type	Enter From List		
	Logger Control	Display Logger	Off/Line Wrap No Line Wrap		
		Output Logger	Yes/No		
		Circular Memory	Yes/No		
		Est LogTime Left	View Only		
		Clear Logger	Yes/No		
	Memory Control	Log Memory Left	Yes/No		
		Memory Map	Yes/No		
		Defragment	Yes/No		
	Analog Out Trim	Trim Io1	Operate / Trim @ 4mA		
		Trim Io2	Operate / Trim @ 4mA		
		Trim Vo1	Operate / Trim @ 2V		
		Trim Vo2	Operate / Trim @ 2V		
		Trim Pgen1	Operate / Trim @ 1Khz		
		Trim Pgen2	Operate / Trim @ 1Khz		
	RTD Calibrate	RTD1	Factory / User Cal		
		RTD2	Factory / User Cal		
	Clock Set	Date (MM.DD.YY)	Numeric Entry		
		Time (HH.MM)	Numeric Entry		
	RS-232 Setup	Baud Rate	Enter From List		

Level A	Level B	Level C	Level D (see manual)	Level E	Level F
		Parity	Enter From List		
		Data Bits	7/8		
		Line Feed	Yes/No		
		Network ID	Numeric Entry		
		RTS Key Time	Enter From List		
	Backlight	Enter From List			
	System Info	Version	View Only		
		Reset Data/Time	View Only	mm.dd.yy.hh.mm.ss	
		Op System P/N	View Only		
		Checksum	View only		
		Code	View Only		
		System Time	View Only	mm.dd.yy.hh.mm.ss	
Language	Enter From List				

Factory Default Parameters

7.1 Factory Default Menu Settings

 CAUTION
--

The following FUT1010 menu settings are pre-set at the factory and should not be altered unless directed to by approved Siemens personnel only.

The following is a list of the default menu settings:

1. Create/Name Site
2. Language and Unit selection
3. Pipe Class selection
4. Gas Parameter selection
5. Pipe Configuration selection
6. Transducer selection

Changing Default Settings

The following Installation Menu procedures are provided for user reference if needed. It is not recommended to change the pre-set menu settings.

Creating Sites

Select Language and Units

Note

Before creating a site select a Language and then English or Metric units from the Meter Facilities menu.

To select English or metric units:

1. In Meter Type menu, scroll to [Meter Facilities] menu. Press <Right Arrow> and select [Preferred Units].

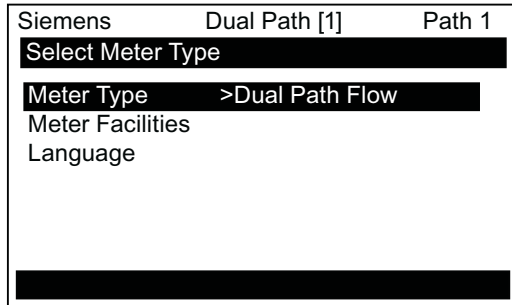

2. Select units and press <ENT> to select. Press <Left Arrow> and <Up Arrow> to return to main menu.

Create a Site

The following is a typical procedure for creating a site.

1. **Before proceeding make sure that English or Metric units have been selected.**
2. At Meter Type press <Right Arrow> to [Dual Path Flow] and then press <ENT>.
3. At [Chan/Path Setup] press <Right Arrow>.
4. Scroll down to [Create/Name Site].
5. Press <Right Arrow> to select the [Create/Name Site] menu and enter a Site name.
6. Press <ENT> to create Site name (e.g., ABC).

Note

To select letters: Press <Right Arrow> to cursor and then press <Up/Down Arrows> to select letters. Press <ENT> when done.

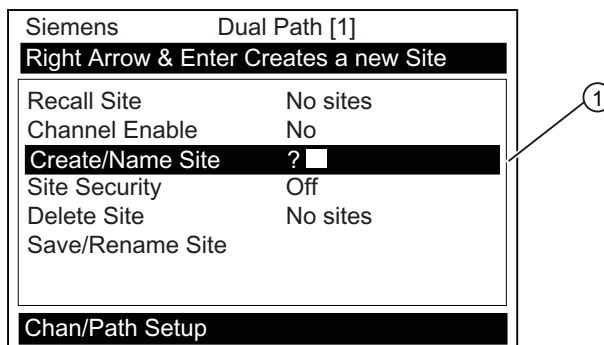

① Insert desired name (8 characters max.)

7. Scroll to [Save/Rename Site]. Press <Right Arrow> then press <ENT> to save site.
8. Press <Left Arrow> and return to the main menu.

Selecting Gas Parameters

It is recommended to edit the Gas Parameters immediately after creating a site. If reliable data is available for gas specific heat ratio, gas viscosity, sound velocity or gas compressibility factor, these settings should be modified. It is particularly important that the approximate (nominal) operating pressure be entered to allow for proper flow profile compensation.

Setting Fixed Pressure

1. At the [Gas Parameters] menu, scroll down to [Fixed Pres. PSIA].
2. Press the <Right Arrow> to select and edit the default Fixed Pressure value. (See table below for additional gas parameter values.)

Siemens Dual Path [1] ABC	
Edit System Fixed Pressure	
Base Temp. F	60.0
Base Pres. PSIA	14.700
Spec. Heat Ratio	1.30
Viscosity (cP)	0.0100
Fixed MW g/mole	0.00
Estimated Vs m/s	400
Fixed Pres. PSIA	=14.700
Z Base	1.000
Z Actual	1.000
AGA8 Comp.	No
Gas Parameters	

The table below indicates the viscosity, specific heat ratio and estimated sound velocity (Vs) for some common gases. The default "Gas Parameters" are suitable for natural gas.

Table 7- 1 Common Gases for Clamp-On Measurement (at 200 psia & 60°F / 14 bar & 15.5°C)

Gas	Viscosity (cP)	Spec. Heat Ratio (Cp/Cv)	Estimated Vs (m/s)
Carbon Monoxide	0.017	1.43	348
Ethane	0.010	1.32	281
Helium	0.019	1.66	1006
Hydrogen	1.410	1.41	1306
Methane	0.011	1.35	437
Natural Gas	0.011	1.33	400
Nitrogen	0.017	1.42	348
Oxygen	0.020	1.42	324

Standard Volume Compensation

If a direct standard volume output is required from the meter, then the entry of an AGA8 compensation table may be needed. Refer to the field manual for further details on configuring the meter for standard volume compensation.

Select Pipe Class

The following is a typical procedure for selecting a pipe class.

1. Press the <Right Arrow> to select [Pipe Class]. Press <Right Arrow> again and scroll to desired Pipe Class.
2. Press <ENT> to select.
3. Pre-programmed Pipe Size and relevant pipe parameters will appear in menu cells. Press <Right Arrow> and scroll to desired pipe size. Press <ENT>. Enter dimensions manually if pre-programmed dimensions do not match application.

Siemens	Dual Path [1]	ABC
Pick Pipe Class		
Path	1	
Pick Pipe Class	ASA Carb. Steel	
Select Pipe Size	8CS40	
Pipe OD <in>	8.625	
Pipe Material	Steel	
Wall Thickness	0.322	
Liner Material	None	
Linear Thickness	0.000	
ThermExp Coef 1/F	0.00	
Mod of Elast PSI	0.00	
Pipe Data		

4. Press the <Left Arrow> and return to the main menu.

Select Pipe Configuration

The following is a typical procedure for selecting a pipe configuration.

1. Scroll down to [Pipe Config] and press the <Right Arrow>.
2. Select a configuration that approximates the conditions upstream of your sensor mounting location. (Refer to the definitions below.)
3. Press <ENT> to save selection.

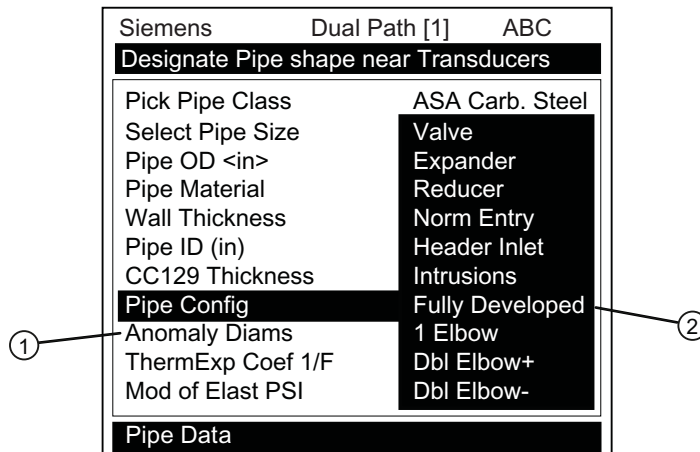

- ① Use this menu cell to enter the number of pipe diameters between the upstream configuration and the sensor installation
- ② Use this menu cell to select the pipe configuration that most accurately represents the upstream pipe condition

4. Press the <Left Arrow> and return to the main menu.

Table 7- 2 Pipe Configuration Option List Definitions

Options	Definitions
Fully Developed	Fully developed flow, as would be expected for very long straight pipe runs or installation downstream of a flow condition.
1 Elbow	Single 90 degree Elbow upstream of sensor installation.
Dble Elbow+	Double out-of-plane Elbows upstream of sensor installation.
Dble Elbow-	Double in-plane Elbows upstream of sensor installation.
Valve	Not available at this time.
Expander	Pipe expansion upstream of sensor installation.
Reducer	Pipe reduction upstream of sensor installation.
Norm Entry	Not available at this time.
Header Inlet	Header or pipe manifold upstream of sensor installation.
Intrusions	Not available at this time.

7.2 Force Transmit

 CAUTION
<p>The Force Transmit and Force Frequency diagnostic procedures are preconfigured at the factory and should only be implemented by approved Siemens personnel.</p>

This diagnostic software routine allows the user to "force" a transmitting condition that can be used to search for an amplitude level (ALC) when Detection Fault or Low Signal alarms are present. The routine forces the flow meter to generate constant transmit bursts while reporting current receive signal strength for the user. To initiate the Force Transmit function, refer to the Short Burst detection mode example shown below.

Setting a Force Transmit condition

1. After [Install] command is invoked and while the flow meter is going through the drive selections press the <ALT> and <MENU> keys simultaneously.

Siemens	Dual Path [1]	ABC
Install Completed?		
Install Path	1	
Transducer Model	1011HP-T1	
Transducer Size	B3	
Xdcr Mount Mode	Direct	
Spacing Offset	Minimum	
Number Index	4	
Spacing Method	Spacer Bar 1012TP	
Ltn Value (in)	0.217	
Install Complete	No	
Empty Pipe Set	Channel Not Setup	
Zero Flow Adjust	Channel Not Setup	
Install Xdcr		

Siemens	Dual Path [1]	ABC
Drive 0		
Install Path	1	
Transducer Model	1011HP-T1	
Transducer Size	B3	
Xdcr Mount Mode	Direct	
Spacing Offset	Minimum	
Number Index	4	
Spacing Method	Spacer Bar 1012TP	
Ltn Value (in)	0.217	
Install Complete	Install	
Empty Pipe Set	Channel Not Setup	
Zero Flow Adjust	Channel Not Setup	
Install Xdcr		

Note

The <ALT> and <MENU> keys must be pressed before the flow meter scans through all the drives, or the Force Transmit function must be initiated again.

2. A typical menu screen will appear as shown below and indicate the current ALC (e.g., 50). This ALC number indicates the current receive signal strength and can be used for further diagnostic purposes.

Siemens	Dual Path [1]	ABC
ForceN	fx=8	m=7 ALC=50
Install Path	1	
Transducer Model	1011HP-T1	
Transducer Size	B3	
Xdcr Mount Mode	Direct	
Spacing Offset	Minimum	
Number Index	4	
Spacing Method	Spacer Bar 1012TP	
Ltn Value (in)	0.217	
Install Complete	Install	
Empty Pipe Set	Channel Not Setup	
Zero Flow Adjust	Channel Not Setup	
Install Xdcr		

Siemens	Dual Path [1]	ABC
Install Path	1	
Transducer Model	1011HP-T1	
Transducer Size	B3	
Xdcr Mount Mode	Direct	
Spacing Offset	Minimum	
Number Index	4	
Spacing Method	Spacer Bar 1012TP	
Ltn Value (in)	0.217	
Install Complete	Install	
Empty Pipe Set	Channel Not Setup	
Zero Flow Adjust	Channel Not Setup	
Install Xdcr		

3. To exit Force Transmit, press the <Left Arrow> and a Detection Fault prompt will appear (see above).
4. Press the <Left Arrow> again and the meter will return to the [Install Xdcr] menu and highlight the [Empty Pipe Set] menu cell.

Setting a Forced Frequency

1. To force a frequency, repeat steps 1 and 2 above, but press <Right Arrow>. The following typical display line will appear: **Drive =0**
2. Using numeric keys enter the frequency and press <ENT>.
3. To complete the Install process after mounting the transducers press <ENT>.
4. If the Force Transmit diagnostic procedure is not used, the normal [Install Complete] function occurs.

User Programmable Parameters

8.1 User Programmable Menu Settings

Although the FUT1010 flowmeter and its meter type are preconfigured at the factory the user can reprogram the Installation menus if needed. Refer to the following procedures to select and/or change the desired menus including the Dual Path Flow menu, Meter Facilities menu and the Language menu.

Selecting Installation Menus

1. Press the <MENU> key and [Meter Type] will be highlighted.
2. Press the <Right Arrow> to [Dual Path Flow] and then press <ENT>.

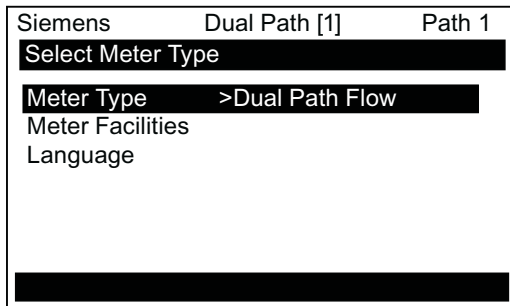

3. The [Dual Path Flow] menu with appear with [Chan/Path Setup] menu item highlighted.

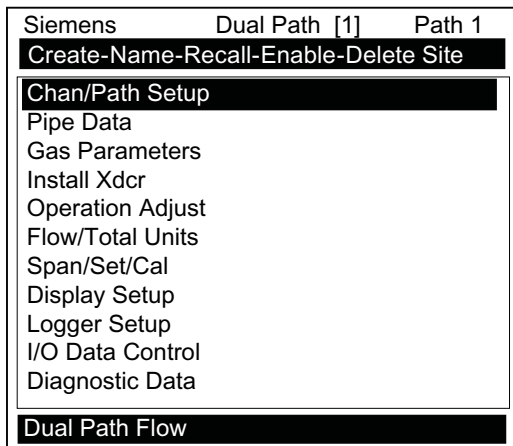

4. Scroll down to the desired menu and press the <Right Arrow> to activate the selected Installation menu.
5. Repeat as necessary to select and change additional Installation menus.

8.1 User Programmable Menu Settings

- 6. To select the [Meter Facilities] menu, scroll down from the [Meter Type] menu and highlight [Meter Facilities].

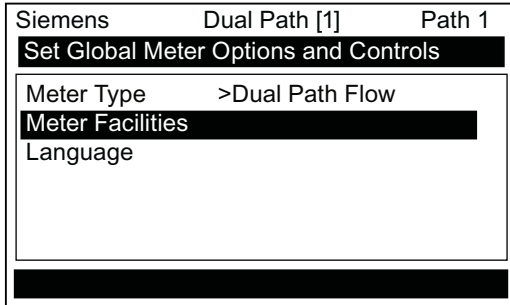

- 7. Press <Right Arrow> to select [Meter Facilities] menu items.

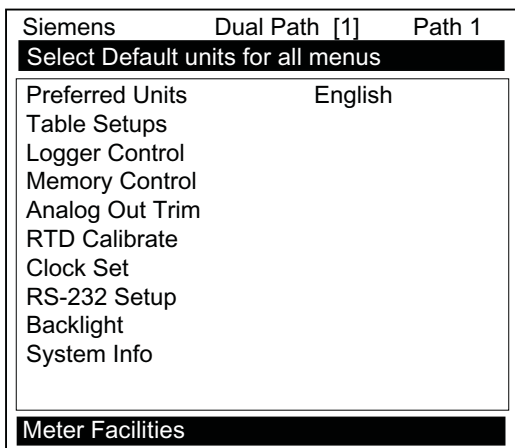

- 8. Scroll down and highlight desired menu item. Input numeric data or press <Right Arrow> to activate menu item.

Selecting a language

1. To select a different language, scroll down from the [Meter Type] menu and highlight [Language].

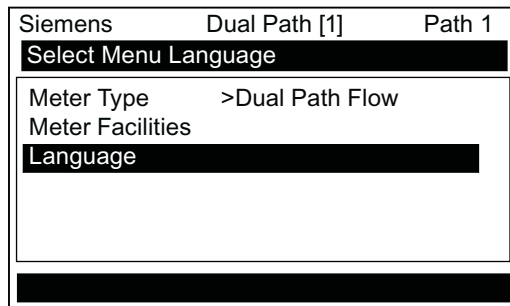

2. Press the <Right Arrow> and the [Language] menu items will appear.

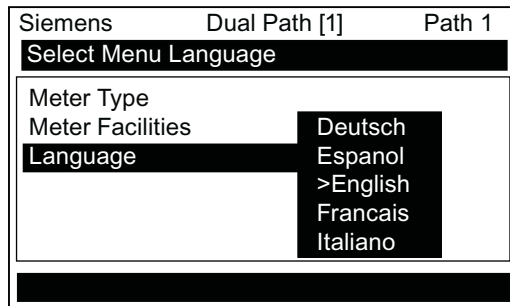

3. Press <Right Arrow> and scroll to desired language.
4. Press <ENT> to select new language.

8.2 Selecting Flow Units

Selecting Flow Units

The [Flow/Total Units] menu is available after selecting a meter type and measurement channel. Use the [Flow/Total Units] menu to select volumetric flow units and an associated time base for the flow rate and total outputs. After making your selections, a view-only menu cell shows the resultant scaling. Another menu cell lets you adjust the output resolution by selecting a display range.

Selecting Flow Volume Units

The [Flow Vol. Units] option list allows you to select the rate units the flowmeter uses to report volumetric flow. The flowmeter uses the computed gas specific gravity to convert volumetric flow to mass flow. The default in English Units for gas is [Cubic Feet].

To select a Volumetric or Mass unit:

1. Press the <MENU> key and [Meter Type] will be highlighted.
2. Press the <Right Arrow> to [Dual Path Flow] and then press <ENT>.
3. The [Dual Path Flow] menu will appear with [Chan/Path Setup] menu item highlighted.
4. Scroll down to the [Flow/Total Units] menu and press the <Right Arrow> to select the [Flow Vol. Units] menu.

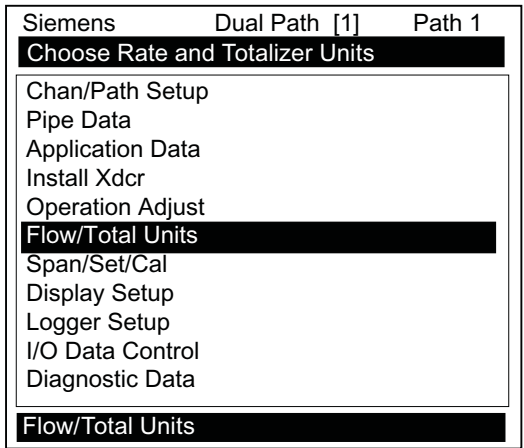

5. Press the <Right Arrow> to select the option list and use the <Up/Down Arrows> to select the desired units.

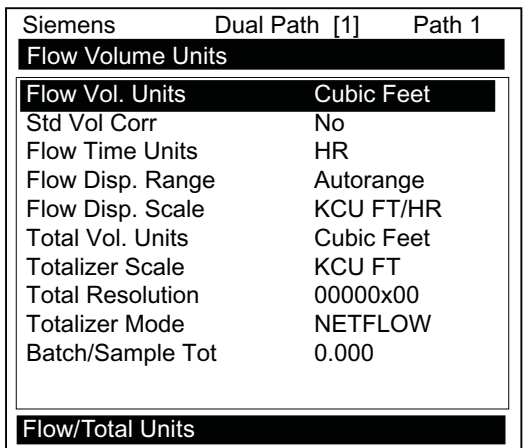

6. Press <ENT> to store selection.

Totalizer Modes

The Totalizer function operates in any of the modes listed below:

Table 8- 1 Totalizer Modes

Mode	Flow Direction	Notes
POSFLOW	positive flow	Accumulates flow in positive direction only
NEGFLOW	negative flow	Accumulates flow in reverse direction only
NETFLOW	positive or negative flow	Adds to positive total; subtracts from reverse total

Note

NETFLOW (default) is best for applications where there may be zero flow for long periods. It minimizes false Totalizer register increments due to data scatter. Press the <Down Arrow> to accept the default setting.

Selecting Totalizer modes

1. Press the <MENU> key and [Meter Type] will be highlighted.
2. Press the <Right Arrow> to [Dual Path Flow] and then press <ENT>.
3. The [Dual Path Flow] menu will appear with [Chan/Path Setup] menu item highlighted.
4. Scroll down to the [Totalizer Mode] menu and press the <Right Arrow> to select the Totalizer Mode option list.

Siemens	Dual Path [1]	Path 1
Choose positive, negative or net total		
Flow Vol. Units		Cubic Feet
Std Vol Corr		No
Flow Time Units		HR
Flow Disp. Range		Autorange
Flow Disp. Scale		KCU FT/HR
Total Vol. Units		Cubic Feet
Totalizer Scale		KCU FT
Total Resolution		NEGFLOW
Totalizer Mode		>NETFLOW
Batch/Sample Tot		POSFLOW
Flow/Total Units		

5. Press the <Up/Down Arrows> to select the desired mode.
6. Press <ENT> to store selection.

Totalizer Mode Controls

From the RS-232 serial port all of the Totalizer commands listed below can be executed using PC keyboard function keys via VT100 terminal key emulation.

Note

Si-Ware or HyperTerminal should be in the Data Display mode when invoking the function keys referenced in the table below. Use the key sequence <Ctrl L> to display the Data Display mode.

Communications Setup

Connect the flowmeter to your PC. Refer to Appendix A for communications setup procedures, if needed.

1. Access Si-Ware or, if using a PC, access HyperTerminal from the PC [Programs] menu, then select [HyperTerminal].
2. In [Connection Description] dialog box, enter a connection name (e.g. FUT1010). Click [OK].
3. In [Phone Number] dialog box, select [Direct to COM 1 (or COM 2)]. Click [OK] to select.
4. In [Properties] dialog box, enter RS-232 parameters. Click [OK].
5. At terminal screen, click [File]. Select [Properties].
6. Select [Settings] tab. At [Emulation] box, select [VT-100].
7. Select [ASCII Setup]. In [ASCII Sending] uncheck boxes. In [ASCII Receiving] check [Append line feeds to incoming line ends.]. Click [OK].
8. At the Terminal screen, press <ENTER> and the Data Display mode appears.
9. If not, to enter the Data Display mode type MENU and then press <Ctrl L>.

Table 8- 2 Totalizer Controls (the "n" in <Fn> = channel number)*

Key	PC #	Command	Description
F1 F2 F3 F4	1	CLRTOT (also clears overflow)	Resetting the Totalizer registers clears all total data accumulated during operation. Note: In Dual Path mode, the Totalizer operates only on the virtual system channel (Ch 3). Therefore in this case, the CLRTOT trigger would be <F3> <1>. Commands that can be invoked from Si-Ware or HyperTerminal: Terminal Command: CLRTOT 1.
F1 F2 F3 F4	2	NOTOT (Totalizer Freeze)	Invoking the NOTOT command disables the Totalizer. Totalization will not resume until you repeat the <Fn> <2> key sequence. When you activate NOTOT, an N precedes the TOTAL symbol (i.e. [NTOTAL]) on the LCD Screen. Commands that can be invoked from Si-Ware or HyperTerminal: Terminal Command: NOTOT 1 = Stop Totalizer Terminal Command: NOTOT 1 = Start Totalizer
F1 F2 F3 F4	3	LAPTOT (Totalizer snapshot)	The LAPTOT command freezes the Totalizer screen display. However, the flowmeter will continue to update its internal registers. The flowmeter will show the current total when you repeat the <F1>< 3> key sequence. When you activate LAPTOT, an L precedes the TOTAL symbol (i.e., [LTOTAL]) on the HyperTerminal screen.
F1 F2 F3 F4	4	CLEAR (Batch/Tot register)	Clears the Batch/Sample Totalizer register. The flowmeter maintains a separate Totalizer register for Batching or Sampling applications but cannot be accessed directly. It is used for relay control only. If you assign the system relay to this function, a momentary (200 mS) relay pulse occurs whenever the BATCHTOT register accumulates a specified liquid quantity. In the [Batch/Sample Tot] menu cell the required total flow volume is entered to activate the relay,. This numeric entry must reflect the selected flow total units. The [Totalizer Scale] menu cell shows the applicable flow total units. The sign of the Batch/Sample Total determines positive or negative accumulation.
F1 F2 F3 F4	5	CLEAR (Makeup Latch)	Clears the Makeup Latch. Refer to the Span Data menu [Set Alarm Levels] and then the [Makeup Latch] On / Off option.

*Use the <F1> key as the "Lead-in command" for 4-Path Totalizer operations.

8.3 Span Data

The Span Data menu allows you to set 0% and 100% output limits for volumetric flow (Vfo), absolute flow (Vfab), sonic velocity (Vs) and specific gravity (Vsg). Each menu cell shows appropriate rate units and time base. If you change flow rate units after spanning the system, the computer automatically updates the output data setup to reflect the change. Span limits apply to both the analog outputs and the on-screen strip chart. The flow outputs operate as follows:

<p>Vfo <i>Spanned Volumetric or Mass Flow:</i></p>	<p>The minimum and maximum flow rate entries establish the Vfo span. The Max Flow menu cell sets 100% of span. The Min Flow menu cell sets 0% of span. Use signed numbers for bi-directional spanning. Note that negative (reverse) flow is always lower than positive flow, whatever its absolute magnitude. For example, for a flow measurement range of -30 CF/M to +10 CF/M, the 4 mA span will be -30 CF/M, and the 20 mA span will be +10 CF/M.</p>
<p>Vfab <i>Spanned Absolute Volumetric Flow Rate:</i></p>	<p>Vfab is the absolute magnitude of the volumetric flow rate (Vfo). There are no menu cells provided to span this output. Vfab shares the Vfo span entries. The Vfab minimum span is always zero. The maximum span for Vfab is the largest absolute value of either the min or the max flow rate (Vfo) entries. For example, a span between +10 CF/M and -30 CF/M, spans the Vfab output from 0 CF/M to 30 CF/M.</p>
<p>Vs <i>Spanned Gas Sonic Velocity:</i></p>	<p>Vs is the sonic velocity in meters-per-second (m/s) of the flowing gas. The min and max Vs entries establish the Vs span. Max Vs (F/S) defines 100% of span. The Min Vs (F/S) defines 0% of span.</p>
<p>Vsg <i>Spanned Gas Specific Gravity:</i></p>	<p>Vsg is the inferred operating specific gravity of the gas. The min and max Vsg entries establish the Vsg span. Max Vsg defines 100% of span and Min Vsg defines 0% span.</p>

Maximum span values represent:	Minimum span values represent:
<p>100% of span Current output of 20 mA Voltage output of 10 Vdc Pulse output of 5000 Hz</p>	<p>0% of span Current output of 4 mA Voltage output of 0 Vdc Pulse output of 0 Hz</p>

To change the default Span Data settings:

1. At [Meter Type], press <Right Arrow> to [Dual Path Flow] and press <ENT>.
2. At [Chan/Path Setup] press <Right Arrow> to <Clamp-on> and press <ENT>.
3. At [Clamp-on] menu scroll down to [Span/Set/Cal] and press <Right Arrow>.

- Highlight [Span Data] and press the <Right Arrow>.

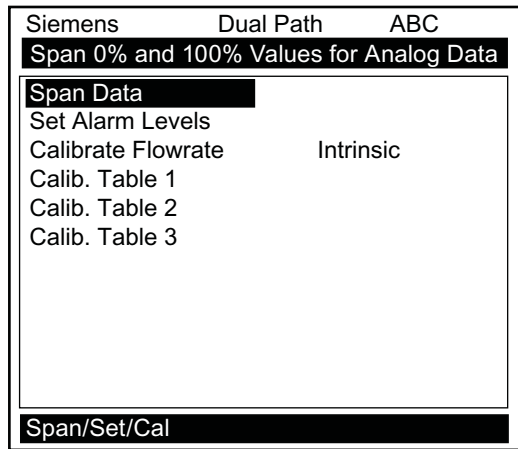

- Highlight [Max Flow] and press <Right Arrow> to. Input 100% flow rate numeric data for 20 mA. Press <ENT> to store data.
- Scroll down to [Min Flow]. Press <Right Arrow> to input 0% flow rate numeric data for 4 mA. Press <ENT> to store data.

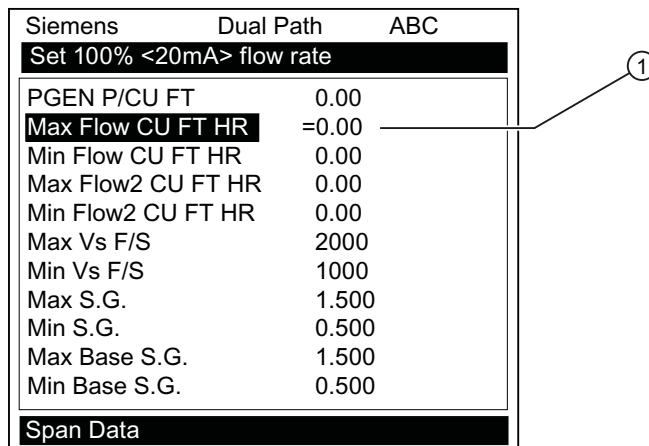

① Input numeric flow data here

PGEN Function

The [PGEN P/Unit Volume] menu cell entry controls a digital output pulse function and is available in all units with 7ME362 and 7ME363 part numbers. It allows the assigning of PGEN digital signal pulses per unit of volume. For example, 1000 output pulses per unit of gas.

Note

The unit of volume is determined by the Volume Units initially selected from the [Total Volume Units] menu cell option list.

8.3 Span Data

Table 8- 3 Input/Output Wiring (TB2) - 7ME39400AL03 Expanded I/O Module

Pin#	Signal	Definition	Description	Function Dual/Quad Path Only
12	PG4	POS [+] Total TTL	0-5000 Hz frequency output , assignable	POS [+] Total TTL
11	PG3	POS [+] Total OC		POS [+] Total OC
10	PG2	NEG [-] Total TTL		NEG [-] Total TTL
9	PG1	NEG [-] Total OC		NEG [-] Total OC
Use reference ground for returns (TB2-2 and TB2-4)				

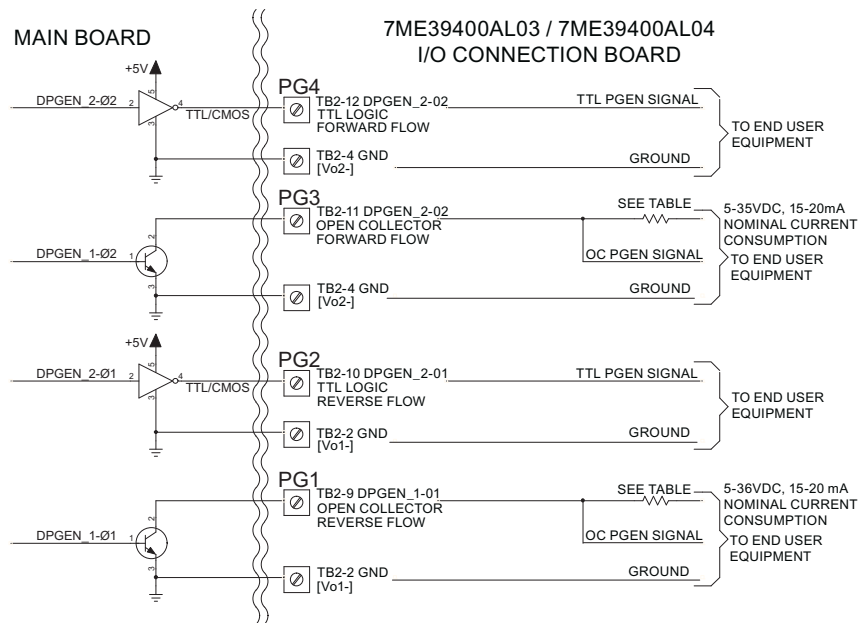

Figure 8-1 7ME39400AL03 Main Board I/O Wiring

Note

TB2-9 and TB2-11 are Open Collector Outputs that require external pull-up resistors for operation. See table for External Supply Voltage and suggested resistor value and ratings. Maximum current into the transistor is 100mA. Maximum Voltage is +36 Vdc.

CAUTION

Negative voltages with respect to ground will permanently damage transistors.

Table 8- 4 Open Collector User Resistor Recommendations

User Supply Voltage (Vdc)	External Resistor (Ohms)	Expected Current Draw (mA)	Recommended Resistor Wattage (Watts)
5	270	18.5	1/2
9	510	17.6	1/2
12	680	17.6	1/2
18	1000	18	3/4
24	1500	16	1
28	1800	15.5	1 1/4
36	2400	15	1 1/4

To change the default PGEN settings:

1. From the [Span Data] menu press <Right Arrow>.
2. Highlight the [PGEN P/Unit Volume] menu cell and press <Right Arrow> to activate the numeric entry.

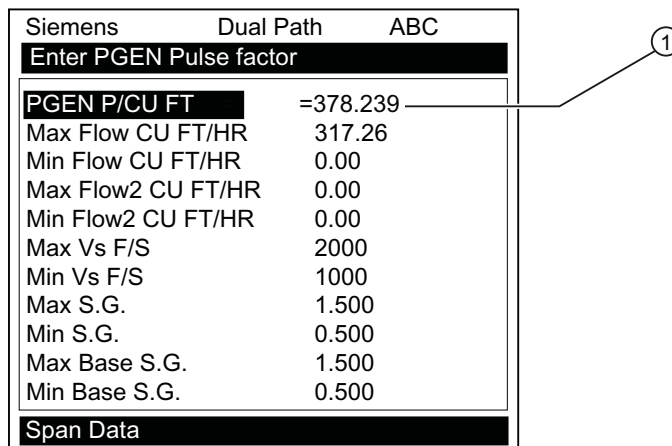

① Input PGEN pulse factor here

3. Use the numeric keys to enter the desired number of PGEN pulses per unit volume.

Note

Ensure that the number entered will provide sufficient resolution while remaining within the 20 Hz to 5000 Hz pulse frequency range. Note that the PGEN output will stop sending pulses at flow rates corresponding to frequencies less than 20 Hz. In this case the PGEN value must then be increased.

4. To store data press <ENT>.

Adjusting the PGEN Output

The default setting for the Digital PGEN output provides a 5000 Hz frequency at an assumed maximum velocity of 100 ft/sec. In certain cases it may be necessary to change this default PGEN value. For example:

- If the PGEN signal cable is very long, then the added cable capacitance may prevent reliable RTU pulse detection at or near 5000 Hz. In this case it may be necessary to decrease the PGEN (Pulses / Unit Volume) setting using the equation below.

$$\text{Pulses / Unit Volume} = \text{MaxFreq} / \text{MaxFlow}$$

Where:

MaxFreq = Maximum desired frequency (Hz)

MaxFlow = Maximum flow rate (Unit Volume / second)

For very low operating flow rates, the pulse frequency may approach the 20 Hz limit of the PGEN output. In this case it may be necessary to increase the PGEN (Pulses / Unit Volume) setting.

$$\text{Pulses / Unit Volume} = \text{MinFreq} / \text{MinFlow}$$

Where:

MinFreq = Minimum desired frequency (Hz). Must be greater than 20 Hz!

MinFlow = Minimum operating flow rate (Unit Volume / second)

Note

If STD VOL is selected then the "unit volume" for PGEN will represent Standard Volume, not actual volume.

Forcing the PGEN Output Frequency

To test the operation of the flowmeter with a Remote Transmitting Unit (RTU), or other pulse counting device, it may be necessary to force the PGEN output frequency, especially when the pipeline is not flowing during flowmeter commissioning. This can be accomplished by setting the AnCal diagnostic value to a flow rate corresponding to the desired frequency output. (Refer to the appropriate paragraph in your manual for operation of the AnCal function.)

The example below demonstrates how to calculate the AnCal flow rate based on the desired pulse output frequency and the entered PGEN (Pulses / Unit volume) setting:

For PGEN setting = 53 Pulses /CU FT and a desired frequency = 1000 Hz

1. Temporarily change flow rate units to CU FT / SEC (Use same volume units as Totalizer.)
2. Set AnCal = $1000 / 53 = 18.868$ CU FT / SEC
3. 1000 Hz frequency should now be observed on the PGEN output.

8.4 Analog Output Setup

The flowmeter provides current, voltage and pulse-rate analog outputs. The [Analog Out Setup] menu allows you to assign data functions for these signals. The transmitter terminal strip contains the analog output terminals.

Table 8- 5 Analog Outputs

Io (Isolated Current)	4 to 20 mA varies in proportion to an assigned data function.
Vo (DC Voltage)	0 to 10 Vdc varies in proportion to an assigned data function.
Pgen (TTL Logic)	0 to 5000 Hz varies in proportion to an assigned data function.
Digital Pgen	User selective pulses per unit flow.

Table 8- 6 Analog Out Setup Data Categories

Vfo	System spanned volumetric/mass flow rate
Vfo2	Additional spanned volumetric/mass flow rate
Vfab	System spanned and signed absolute flow
Vs	Spanned gas sonic velocity
Valc	Received signal amplitude
Vtrb	Relative degree of gas turbulence
Vsg	Spanned specific gravity
Base S.G.	Spanned S.G. referenced to user temperature
Viscosity	Gas viscosity in centistoke units
lin1, lin2, lin3, lin4	Represents a re-transmit of the analog input signals (e.g. Pressure and Temp inputs can be transmitted on the 4-20mA output).

Note

For Multi-Path flowmeters: "1" = Path 1, "2" = Path 2, "3" = Path 3, "4" = Path 4 and "S" represents the system or average channel. These characters appear to the left of the option list parameter.

Io Output Functions

Assigning a function to the current output:

1. From the [Chan/Path Setup] menu scroll to [I/O Data Control].
2. Press <Right Arrow> to highlight the [Analog Out Setup] menu.

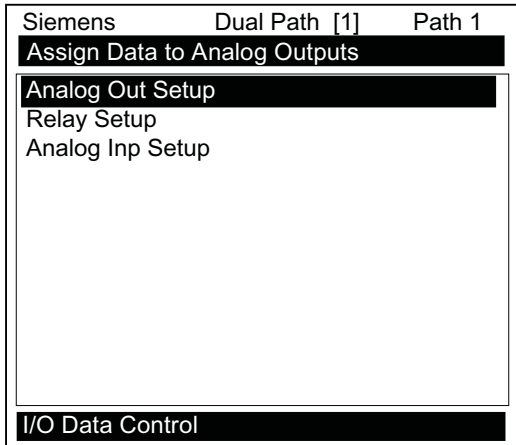

3. Press <Right Arrow> twice to access the [Io] option list.
4. Move the cursor to the desired data function by pressing <Up/Down Arrow>.

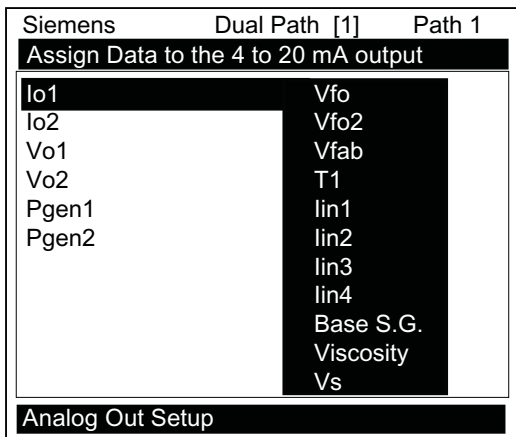

5. To store selection press <ENT>.

Vo Output Functions

The Vo analog output is a 0-10 VDC signal that varies linearly in relation to a selected function.

Assigning a function to the voltage output:

1. From the [Analog Out Setup] menu, press <Right Arrow> to access the [Vo1] option list.
2. Move the cursor to the desired data function by pressing <Up/Down Arrow>.
3. To store selection press <ENT>.

Note

Refer to drawing 1010N-7-7 in Appendix A for Analog output connections.

8.5 Analog Input Setup

The optional Analog Input Setup function assigns an active analog input to a measurement channel/path. The flowmeter provides four DC current input ports for single channel and Dual Path units. The DC current input ranges from a zero level of 4 mA to a full scale of 20 mA. The [Analog Inp Setup] menu cell allows you to enable this port and then span it to any desired scaling.

For example, when using the analog input for pressure the numeric variables might be spanned as follows: 4mA=14.7 PSIA and 20mA=1014.7 PSIA.

Note

The flowmeter expects "absolute" pressure. If the external device reports "gauge pressure" then make sure to span the pressure input so that 4mA represents 1 ATM (14.7 PSIA or 1.014 BARA) and not 0.0.

The various flowmeter models allow you to associate the analog input to active system variables such as specific gravity, viscosity and others (see table below).

Note

Refer to the Installation Drawings or I/O Module markings for the locations of these inputs and wiring procedures.

Table 8- 7 I/O Data Control Menu

I/O Data Control	Analog Inp Setup	lin1	Input	Off Aux PSIA BARA T1 Deg F T1Deg C
			4 mA 20mA	Numeric entry Numeric entry
		lin2 / lin3 / lin4	See In1 option list	

Note

The Aux input is only used as a feed through to the Datalogger.

The flowmeter recognizes the first analog input variable that is assigned to any given parameter and ignores any subsequent input with the same assignment. For example, if lin1 and lin2 are both assigned to represent pressure (PSIA), the flowmeter will only use the pressure input from lin1.

Setting the Analog Current Input

The DC current input port must be enabled first. From the [Analog Inp Setup] menu proceed as follows:

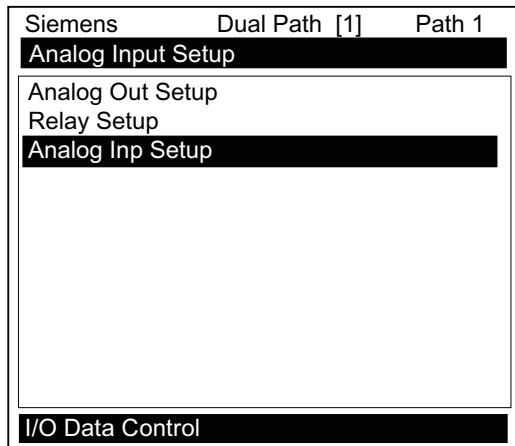

1. Access the [lin1] option list by pressing the <Right Arrow> twice.

Siemens	Dual Path [1]	Path 1
Enable & Span analog input current		
lin1		Off
lin2		>Aux
lin3		PSIA
lin4		BARA
		T1 Deg F
		T1 Deg C
Analog Inp Setup		

2. Move the cursor down to [Aux] by pressing the <Down Arrow> and then press <ENT>. This enables the port to receive an input current. The cursor moves to [4 mA].

Siemens	Dual Path [1]	Path 1
Assign Analog Input Type		
Input		Aux
4 mA		0.000
20 mA		0.000
lin1		

3. To enable numeric entry, press the <Right Arrow>. Type a numeric value corresponding to a 4 mA input signal.
4. To store the data press <ENT>. This moves the cursor to [20 mA].
5. To enable numeric entry, press the <Right Arrow>. Type the numeric value corresponding to a 20 mA input signal.
6. To store the data, press <ENT>.

8.6 Logger Control

Logger Control Menu

The Logger Control menu in the [Meter Facilities] menu provides the Logger controls for the flowmeter measurement channels and paths. It allows the user to select data items/alarm events, a logging interval and a destination for Logger reports. While the Logger Setup menu is measurement channel/path specific, this Logger Control menu provides global control functions. This means that the settings made here apply to all measurement channels/paths, meter types, operating modes, etc. This is possible because the flowmeter stores logged data in a single file.

The [Est LogTime Left] menu view-only menu cell shows an estimate of the hours and minutes of logging time remaining. For convenience sake, the Display Logger command is essentially a duplicate of the menu cell in Logger Setup. It sends Logger data to the graphic screen with or without line wrapping. The Output Logger command sends data to an external device via the RS-232 serial port. The Clear Logger command erases the entire Logger file.

1. From the Meter Facilities menu access the [Logger Control] menu by pressing the <Right Arrow>.
2. Scroll down to [Logger Control]. Press the <Right Arrow> to access the [Logger Control] menu option list.

Siemens	Dual Path [1]	Path 1
Datalogger Control		
Preferred Units	English	
Table Setups		
Logger Control		
Memory Control		
Analog Out Trim		
RTD Calibrate		
Clock Set	06.23.09	12.46.56
RS-232 Setup	38400 Odd [0]	
Backlight	On	
System Info		
Meter Facilities		

Table 8- 8 Logger Control Menu Option List

Logger Control	Display Logger	Off Line Wrap No Line Wrap
	Output Logger	No Yes
	Circular Memory (Available for Multi-Path units only)	No Yes
	Est LogTime Left	--:--
	Clear Logger	No Yes

Display Logger

This menu cell allows you to send the Logger contents to the display screen. This command is effective only after a successful install. You can set the report to scroll on the screen with or without line-wrap. Selecting line wrap, forces a line feed after approximately 40 characters. In addition, you have to enable datalogging and then select items in the Logger Setup menu. Note that this command transmits the data from both channels/paths.

To send Logger contents to the display screen:

1. Press <Right Arrow> to access the [Display Logger] option list.

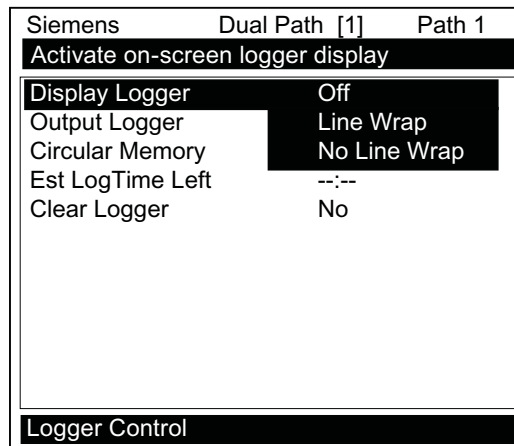

2. Scroll cursor to either [Line Wrap] or [No Line Wrap] by pressing <Up/Down Arrow>.
3. To view Logger contents press <ENT>.
4. To return to [Logger Control] press <MENU>.

Output Logger

This menu cell allows you to send the Logger contents to an external device (usually a computer or printer) via the flow meter's RS-232 Serial I/O port. This command is effective only after a successful install. In addition, you have to enable datalogging and select data items in the [Logger Setup] menu.

The flowmeter interfaces with most serial printers or personal computers for Logger printouts. You must use the proper cabling between the flowmeter and the external device. In addition, you must configure the RS-232 Setup correctly. You should turn off the Logger function before you transmit an extensive printout. This will avoid contaminating the printout with new Logger data. Logger reports are sequential ASCII text files.

To send Logger contents to the RS-232 Serial Port:

1. Check the flowmeter-to-external device connections and your RS-232 Setup parameters (see RS-232 Setup menu).
2. To access the [Output Logger] option list press <Right Arrow>.
3. Scroll the cursor to [Yes] by pressing <Up/Down Arrow>.

8.6 Logger Control

4. To transmit Logger contents to external device via the serial port press <ENT>.
5. To stop printout press <Left Arrow>.

Circular Memory

In its default mode, the Logger collects data until its memory becomes full. At that time the flowmeter suspends datalogging and cannot resume until the Logger memory is cleared (see Clear Logger command). Circular Memory allows the Logger to "write over" its oldest records when memory reaches full capacity. If you enable [Circular Memory], you are assured of always collecting the most recent data. But also remember that you will lose the oldest Logger reports and that further invoking of [Circular Memory] deletes the current contents of the Logger.

To setup and enable Circular Memory:

1. The Logger Mode menu must have the [Memory] menu cell selected.
2. Logger items must be selected (e.g., Site ID, Date, Time, etc.).
3. All active channels/paths in the Channel Setup menu must be disabled. To disable active channels, select the [Channel Enable] menu cell and then [No].
4. In the Logger Control menu, select [Circular Memory].
5. Press <Right Arrow> to access the [Circular Memory] option list.
6. Move the cursor to [Yes] by pressing <Up/Down Arrow>.
7. To store selection press <ENT>.
8. Lastly, re-enable the channels/paths that you disabled earlier to begin logging.

Est LogTime Left

Est LogTime Left is a "view-only" menu cell that shows an estimate of the amount of Logger time remaining in hours and minutes. This menu cell becomes active after you enable datalogging. Selecting [Circular Memory] and/or event-based datalogging (see Logger Setup), blanks the [Est LogTime Left] field and is based on the log interval and data selections made in the Logger Setup.

Clear Logger

If you use the Logger in its default mode, eventually you will use all the memory available for Logger storage. When this occurs, you will not be able to log more data until you free up the memory. The [Clear Logger] command erases ALL stored Logger data. Therefore, you should evaluate the currently stored data, and print any valuable information before using this command.

Note

Saved Sites also consume Logger RAM.

Clearing Logger Memory

1. To access the [Clear Logger] option list press <Right Arrow>.
2. Move the cursor to [Yes] by pressing <Up/Down Arrow>.
3. To clear the memory press <ENT>.

Functions

9.1 Gas Parameters Menu

This menu becomes available after picking a flowmeter type and measurement path. We recommend that you edit the Gas Parameters immediately after creating a new Site Setup, however any item in the [Gas Parameters] menu can be altered at any time, even during normal flowmeter operation. The default settings are probably suitable for most applications, however if reliable data can be provided regarding the gas specific heat ratio, gas viscosity or gas compressibility factor, these settings should be modified.

The FUT1010 Gas flowmeter uses the Gas Parameters data to establish the specific gravity and the volume correction factors required for mass flow or standard volume computations.

- The base temperature and base pressure settings are customer provided and are used for standard volume correction.
- The specific heat ratio item is required for the computation of the average gas specific gravity.
- The Viscosity (cP) item is required for proper flow profile compensation.
- The fixed MW (molecular weight) allows you to force the flowmeter to use a specific molecular weight for well-defined gases.
- The fixed Pressure entry allows for a fixed value to be entered when no external pressure (analog input) is available.
- The flowmeter is also capable of providing an AGA8 volume compensation for fixed gas compositions. This is accomplished by creating an offline lookup table that contains the compressibility and density values for a defined range of pressure and temperature. Once completed, the table must be downloaded to the flowmeter. Refer to AGA8 table generation instructions in this section.

The list below shows the defaults and description for all the [Gas Parameters] menu items. Each item in the [Gas Parameters] menu can be edited by the user. Pressing the <Right Arrow> key on any of these menu items will enable numeric entry and allowing the user to override the default values.

Siemens	Dual Path [1]	ABC
Gas Parameters		
Base Temp. F	60.0	
Base Pres. PSIA	=14.700	
Spec. Heat Ratio	1.30	
Viscosity (cP)	0.0100	
Fixed MW g/mole	0.00	
Estimated Vs m/s	350	
Fixed Pres. PSIA	14.700	
Z Base	1.000	
Z Actual	1.000	
AGA8 Comp.	No	
Gas Parameters		

9.1 Gas Parameters Menu

Table 9- 1 Gas Flowmeters Menu Structure and Default Values

Gas Flowmeters	Base Temp	15.5°C (60°F)	Enter reference temperature in C or F.
	Base Pres. PSIA	14.7 PSIA (1.014 BARA)	Enter reference pressure in PSIA or BARA.
	Spec. Heat Ratio	1.3	Enter gas specific heat ratio (constant pressure to constant volume.)
	Viscosity (cP)	0.010 centipoise	Enter absolute gas viscosity in centipoise.
	Fixed MW g/mole	0.0 grams/mole	Enter fixed molecular weight to override automatic computation.
	Estimated Vs m/s	450 m/sec	Enter the nominal sound velocity of the gas if significantly different from this default.
	Fixed Pres. PSIA	14.7 PSIA (1.014 BARA)	Enter fixed operating pressure if external input is not available.
	Z Base	1.000	Enter the compressibility factor for the gas at base conditions.
	Z Actual	1.000	Enter fixed compressibility factor where pressure, temperature and gas composition do not vary significantly.
	AGA8 Comp	YES/NO	If a valid AGA8 table is installed then select [YES] to activate the AGA8 compensation (Std. Vol. Comp from the Flow/Total Units menu must also be selected).

Base Temp and Base Pres. PSIA

The base temperature and base pressure represents the conditions to which the reported volumetric flow rate and volumetric total will be compensated to (standard or normal conditions) as described in the equation below. The required units for data entry are determined by the [Preferred Units] menu cell (English or Metric) selected in the [Meter Facilities] menu. If metric units are selected then the units for temperature and pressure will be degrees Celsius and BARA (absolute) respectively. For English units, temperature and pressure will be in degrees Fahrenheit and PSIA.

$$Q_{base} = Q_{act} \times \frac{P_{act}}{P_{base}} \times \frac{T_{base}}{T_{act}} \times \frac{Z_{base}}{Z_{act}}$$

where:

Q = Volumetric flow rate

P = Pressure (absolute)

T = Temperature (absolute)

Z = Compressibility

base = Base conditions (pressure and temperature)

act = Actual flowing condition (pressure and temperature)

Spec. Heat Ratio

The specific heat ratio refers to the ratio of the gas specific heat at constant pressure to specific heat at constant volume. This ratio (along with the measured gas temperature and sonic velocity) allows the flowmeter to compute (dynamically) the average specific gravity of the gas. The default value of 1.3 is suitable for most gases, but should be modified if this value is known for your specific application.

Viscosity (cP)

The absolute gas viscosity (along with the measured gas density and raw flow velocity) is used by the flowmeter to compute the instantaneous Reynolds number. The Reynolds number is then used to derive the correction factor the required flow profile compensation.

The expected unit for viscosity is "centipoise." The default value of 0.01 is suitable for most gases, but should be modified if this value is known for your specific application.

The Reynolds number is computed as indicated:

$$R_n = 645 \times \frac{\rho \times id \times V_f}{cP}$$

where: ρ = density at flowing conditions (g/cc)

id = spool inside dia (in)

Vf = Flow velocity (ips)

cP = absolute gas viscosity (centipoise)

Fixed MW g/mole

The flowmeter uses the measured gas temperature, sonic velocity and specific heat ratio to compute the average specific gravity of the gas being measured. This feature is useful for identification of the gas as well as for proper reporting of mass flow in cases where the gas composition varies.

In cases where the gas composition does not vary significantly, a fixed value for molecular weight can be entered here. A non-zero value for Fixed MW (grams/mole) will override the automatic computation of specific gravity. Setting Fixed MW back to 0.0 will cause the automatic specific gravity computation to resume.

Estimated Vs

The [Estimated Vs] menu cell allows the numerical entry for the nominal sound velocity of natural gas. Contact your local representative for gases other than natural gas.

Note

Changing the Estimated Vs will require repeating the Transducer Install procedure.

Fixed Temp and Fixed Pres. PSIA

The flowmeter can accept temperature and pressure input from an external direct sensing instrument. If you do not have external temperature or pressure available, then the flowmeter will automatically use the fixed value(s) as the assumed gas temperature and/or pressure. Please note that for proper reporting of volume corrected flow, mass flow or specific gravity, the flowmeter must have reliable temperature and pressure input. However, if the operating temperature and pressure is very constant, then fixed values may be used where higher accuracy is not required.

Note

For flowmeters with on-board RTD temperature capability, the [Fixed Temp] flowmeter will not be present. In this case, a fixed value for temperature can be set by spanning the analog input 4mA setting to the desired temperature value. Providing the analog input channel is not connected to any current source, the valued returned will be the 4 mA temperature value.

The required units for data entry are determined by the [Preferred Units] menu cell (English or Metric) selected in the [Meter Facilities] menu. If [Metric] units are selected then the units for temperature and pressure will be degrees Celsius and BARA (absolute), respectively. For English units, temperature and pressure will be in degrees Fahrenheit and PSIA.

Z Base

The [Z Base] menu cell allows entry for the compressibility factor, at base conditions, for a given gas composition. If using the internal AGA8 compensation, Z Base should be set appropriately for the gas composition.

Z Actual

The [Z Actual] menu cell allows for a fixed entry of the compressibility factor in cases where pressure, temperature and gas composition do not vary significantly. If standard volume compensation is desired then enter the average compressibility factor for the specific gas application.

AGA8

All FUT1010 gas flowmeters include a facility for performing internal volume compensation using an AGA8 lookup table. This volume correction method is suitable and accurate for applications where the gas composition does not vary significantly or where the gas is infrequently sampled (not automatically sampled).

Note

In cases where automatic sampling is performed, a gas flow computer must be used in conjunction with the FUT1010 flowmeter to provide the most accurate volume compensated flow output.

The internal AGA8 lookup table provides the flowmeter with the actual gas density (Kg/m³) and compressibility factor (Z Actual) for the indicated pressure and temperature (as obtained via the analog input or fixed P/T entry). These values are then used to compute either mass flow rate or standard volume corrected flow rate as indicated in the Flow/Total Units menu.

The table must first be generated externally using a software package which computes the appropriate density and compressibility factors for the specified gas composition.

Note

Siemens recommends using Si-Ware to generate this lookup table.

After the lookup table is generated and appropriately formatted, it can then be downloaded to the flowmeter via the serial data port. At any time during operation a new table may be downloaded to the flowmeter, should a change in gas composition require the calculation of new Z-factors and Density values.

The AGA8 lookup table is essentially a 10 x 10 array or grid containing both Z-factor and Density, with a 10 point temperature and 10 point pressure index. Based on the current temperature and pressure measurement, Z-factor and Density are interpolated to provide accurate volume correction. The table should be configured to cover the full range of operating temperature and pressure; however, if the measured pressure or temperature falls outside the table limits the flowmeter lookup algorithm will extrapolate the Z-factor and Density values accordingly.

If a gas composition was provided to Siemens with the purchase order, then the flowmeter may already be configured for the specified gas composition and would be indicated in the documentation provided with each flowmeter. If a new table or an updated table is required, follow the AGA8 table generation and installation instructions below.

Note

Table values are installed into the flowmeter using a facility providing direct access to many system variables without error handling, therefore, care should be exercised during the formatting of this table prior to downloading to the flowmeter.

When generating an AGA8 lookup table follow these guidelines (refer to Example #1 table below).

- The table values for pressure must be arranged in ascending order and consist of exactly 10 points. The units of entry must be PSIA.
- The table values for temperature must be arranged in ascending order and consist of exactly 10 points. The units of entry must be degrees Kelvin.
- The table values for Density and Z-factor must be entered for each combination of entered temperature and pressure (100 points for each). The units of entry for density must be Kg/m³.

AGA8 Table Generation and Installation Instructions

1. Start by first creating the gas composition file within the Si-Ware software application.
2. Next customize the output units by selecting PSI absolute and degrees Kelvin.
3. Now determine the application range for pressure and temperature with sufficient margin to insure that the measured temperature and pressure always falls within the table limits.
4. Compute the temperature increment for 10 points: $T_{incr} = (T_{max} - T_{min}) / 9$, then round off T_{incr} to the next higher integer. Now recompute $T_{max} = T_{min} + 9 * T_{incr}$.
5. Repeat Step 4 to compute the pressure increment "Pincr," "Pmin" and "Pmax."
6. From the Si-Ware menu select [Perform Range Calculation] and [Varying T & P], then enter the temperature and pressure range and increments from Steps 4 and 5. Verify that there are exactly 10 "temp. points" and 10 "pres. points" indicated.
7. Select [Density] and [Z-factor] from the output data menu, then click on [Compute].
8. From the Si-Ware toolbar select [Table] then [Copy All]. These tables can now be pasted into EXCEL (see Example #1 table below). Select "General" formatting to remove any commas from the data.
9. The final text file must follow the syntax indicated in the example shown on the next page. To accomplish this the data needs to be manipulated within EXCEL and then saved as a comma separated file, then further modification will be necessary (using a text editor) to obtain the final text file format shown in the Example #2 table below.

Note

The data strings must conform to the syntax rules listed in the Syntax Rules table below.

10. Save the final AGA8 text file in an appropriate directory on your PC.
11. Now that the file is properly formatted, it can be downloaded to the flowmeter using HyperTerminal or other communication software. With the RS-232 baud rate set to 9600 or lower, confirm that the flowmeter is properly communicating with the terminal program.

Note

If the flowmeter is actively measuring flow the path must be disabled by either using the flowmeter keypad or HyperTerminal. In HyperTerminal type: MENU. Select the Chan/Path menu and then [Channel Enable]. Select the [No] option.

12. Select the desired default path for download of the AGA8 table. In HyperTerminal type "cv 2" for Dual Path systems. Press <ENT>.
13. Select [Send Text File] from the HyperTerminal menu and proceed to transfer the AGA8 compensation file created and saved in Step 10.
14. Once the table is installed, set the [AGA8 Comp] menu to [Yes] to enable AGA8 compensation. Note that the [Std. Vol Comp] menu must also be set to [Yes] if standard volume flow output is desired.

Table 9- 2 Syntax Rules

<p>Syntax for entry of the pressure and temperature index array is: cv pres_grid[i] pressure_i where i = 0 to 9 cv temp_grid[j] temp_j where j = 0 to 9</p>
<p>Syntax for entry of the density and Z factor values is: cv dens_grid[k] density_k where: k = 0 to 9 cv z_grid[k] zfactor_k where: k = 0 to 9</p>

Note

To simplify the creation of the AGA8 table file, the data can be arranged with comma separators indicating the next item in the array. In this way the "cv" command does not have to be issued for each data point.

For example, the string below loads all temperature points for the entire temperature array from point 0 to point 9 or (0 to 87 deg C).

cv temp_[0] 273.0, 283.0, 293.0, 303.0, 313.0, 323.0, 333.0, 343.0, 353.0, 363.0

Table 9- 3 Example #1 - Density (kg-m/m³) vs. Pressure and Temperature

	100	250	400	550	700	850	1000	1150	1300	1450
273	5.4641	13.7105	22.4055	31.5813	41.2659	51.4778	62.2197	73.4705	85.1762	97.2428
283	5.2928	13.2438	21.5764	30.3107	39.462	49.0368	59.0296	69.4174	80.1557	91.1746
293	5.1324	12.8109	20.8158	29.1586	37.8464	46.8787	56.2454	65.9241	75.8769	86.0497
303	4.9819	12.4082	20.1146	28.107	36.3869	44.9499	53.7836	62.8666	72.1668	81.6406
313	4.8402	12.0322	19.4653	27.1416	35.059	43.2106	51.5835	60.1575	68.9049	77.7902
323	4.7067	11.6801	18.8618	26.251	33.8433	41.6306	49.5998	57.7324	66.0045	74.3861
333	4.5806	11.3497	18.299	25.4258	32.7244	40.186	47.7979	55.5432	63.4009	71.3457
343	4.4612	11.0388	17.7724	24.6582	31.6897	38.8579	46.1506	53.5524	61.045	68.6067
353	4.3481	10.7456	17.2785	23.9418	30.729	37.631	44.6363	51.731	58.8988	66.121
363	4.2408	10.4688	16.8138	23.2712	29.8337	36.4927	43.2375	50.0554	56.9319	63.8507

Functions

9.1 Gas Parameters Menu

Table 9- 4 Z-factor vs. Pressure and Temperature

	100	250	400	550	700	850	1000	1150	1300	1450
273	0.9825	0.9571	0.9318	0.9099	0.8817	0.8575	0.8341	0.8119	0.7913	0.7729
283	0.9842	0.9615	0.9389	0.9166	0.8947	0.8735	0.8531	0.8338	0.816	0.7999
293	0.9858	0.9654	0.9452	0.9254	0.9061	0.8874	0.8696	0.8528	0.8372	0.8232
303	0.9872	0.9689	0.9508	0.9332	0.9161	0.8996	0.8839	0.8692	0.8556	0.8434
313	0.9884	0.972	0.9558	0.9401	0.9249	0.9104	0.8966	0.8837	0.8718	0.861
323	0.9896	0.9747	0.9603	0.9463	0.9328	0.9199	0.9077	0.8964	0.886	0.8766
333	0.9906	0.9772	0.9643	0.9518	0.9398	0.9284	0.9176	0.9077	0.8986	0.8904
343	0.9915	0.9795	0.9679	0.9567	0.946	0.936	0.9265	0.9177	0.9098	0.9026
353	0.9923	0.9815	0.9711	0.9612	0.9517	0.9428	0.9344	0.9268	0.9198	0.9136
363	0.9931	0.9834	0.9741	0.9652	0.9568	0.9489	0.9416	0.9348	0.9288	0.9234

Table 9- 5 Example #2

```

cv temp_grid[0] 273,283,293,303,313,323,333,343,353,363
cv pres_grid[0] 100,250,400,550,700,850,1000,1150,1300,1450
cv dens_grid[0] 5.4641,13.7105,22.4055,31.5813,41.2659,51.4778,62.2197,73.4705,85.1762,97.2428
cv dens_grid[10] 5.2928,13.2438,21.5764,30.3107,39.462,49.0368,59.0296,69.4174,80.1557,91.1746
cv dens_grid[20] 5.1324,12.8109,20.8158,29.1586,37.8464,46.8787,56.2454,65.9241,75.8769,86.0497
cv dens_grid[30] 4.9819,12.4082,20.1146,28.107,36.3869,44.9499,53.7836,62.8666,72.1668,81.6406
cv dens_grid[40] 4.8402,12.0322,19.4653,27.1416,35.059,43.2106,51.5835,60.1575,68.9049,77.7902
cv dens_grid[50] 4.7067,11.6801,18.8618,26.251,33.8433,41.6306,49.5998,57.7324,66.0045,74.3861
cv dens_grid[60] 4.5806,11.3497,18.299,25.4258,32.7244,40.186,47.7979,55.5432,63.4009,71.3457
cv dens_grid[70] 4.4612,11.0388,17.7724,24.6582,31.6897,38.8579,46.1506,53.5524,61.045,68.6067
cv dens_grid[80] 4.3481,10.7456,17.2785,23.9418,30.729,37.631,44.6363,51.731,58.8988,66.121
cv dens_grid[90] 4.2408,10.4686,16.8138,23.2712,29.8337,36.4927,43.2375,50.0554,56.9319,63.8507
cv z_grid[0] 0.9825,0.9571,0.9318,0.9066,0.8817,0.8575,0.8341,0.8119,0.7913,0.7729
cv z_grid[10] 0.9842,0.9615,0.9389,0.9166,0.8947,0.8735,0.8531,0.8338,0.816,0.7999
cv z_grid[20] 0.9858,0.9654,0.9452,0.9254,0.9061,0.8874,0.8696,0.8528,0.8372,0.8232
cv z_grid[30] 0.9872,0.9689,0.9508,0.9332,0.9161,0.8996,0.8839,0.8692,0.8556,0.8434
cv z_grid[40] 0.9884,0.972,0.9558,0.9401,0.9249,0.9104,0.8966,0.8837,0.8718,0.861
cv z_grid[50] 0.9896,0.9747,0.9603,0.9463,0.9328,0.9199,0.9077,0.8964,0.886,0.8766
cv z_grid[60] 0.9906,0.9772,0.9643,0.9518,0.9398,0.9284,0.9176,0.9077,0.8986,0.8904
cv z_grid[70] 0.9915,0.9795,0.9679,0.9567,0.946,0.936,0.9265,0.9177,0.9098,0.9026
cv z_grid[80] 0.9923,0.9815,0.9711,0.9612,0.9517,0.9428,0.9344,0.9268,0.9198,0.9136
cv z_grid[90] 0.9931,0.9834,0.9741,0.9652,0.9568,0.9489,0.9416,0.9348,0.9288,0.9234
    
```

9.2 Gas Data Menu

This menu shows the current Reynolds number used by the flowmeter to implement flow profile compensation, as well as operating pressure and temperature and computed gas properties.

Siemens	Dual Path	ABC
Current Reynolds number		
TEMP 1		0.00 F
TEMP 2		0.00 F
Reynolds #		784
Specific Gravity		1.718 OFF
Base S.G.		
Temperature		102.20 Deg F
Pressure		26.30 PSIA
Volume Corr.		1.65
Viscosity cS		4.756 OFF
Gas Data		

- ① Actively displays pressure and temperature from either analog input, computation or fixed gas parameters menu.

Table 9- 6 Gas Data Menu Items

TEMP 1	Measured temperature from Channel 1 RTD.*
TEMP2	Measured temperature from Channel 2 RTD.
Reynolds Number	The flowmeter corrects the current flow rate in accordance with this Reynolds number. This number is determined from pipe ID, current flow rate and gas kinematic viscosity.
Specific Gravity	Actual specific gravity of gas computed as follows: molecular weight of gas divided by molecular weight of air.
Base S.G.	Specific Gravity measured at base temperature.
Temperature	Measured temperature (analog input or from RTD input).
Pressure	Measured pressure (Analog input or from Gas Parameters menu.)
Volume Corr.	Flow rate/total multiplier used to correct the measured volume to standard volume.
Viscosity	Kinematic viscosity of gas.

* If the analog input for temperature is enabled it will override the internal RTD temperature measurement and TEMP1 will reflect the analog input temperature instead. For Dual Path operation only TEMP1 is used for volume correction.

9.3 Operation Adjust Menu Settings

Introduction

The Operation Adjust menu becomes available after picking a meter type and measurement channel. It is recommended that you use it after the sensors are installed and operating to "fine-tune" the meter's output characteristics.

Each application presents different data display and output requirements due to unique pipe and gas conditions. Use the [Operation Adjust] menu to match flowmeter operation to the site. You can set damping controls for the primary flow rate output. You can define a Deadband, (usually a very low flow rate), below which the flow output will be forced to zero. You can also select the flowmeter response to a continuous Fault condition.

Damping Control

The flowmeter provides two different data output filter types, Time Average and SmartSlew. Time Average (recommended) integrates the instantaneous flow rate over a selectable time period. Use the Time Average function when stability in flow reading is essential. A value entered (in seconds) sets the time it takes the flowmeter to respond to a rate change. The default is 10 seconds. Enter any amount of time up to 60 seconds maximum.

SmartSlew performs data scatter damping during steady flow periods while maintaining the ability to respond to changing flow rates. SmartSlew values range from [1 to 9]. Pick a higher number to slow flowmeter response to a rate change.

Setting the Time Average (default):

1. From the [Dual Path Flow] menu scroll to the [Operation Adjust] menu and press <Right Arrow>.
2. At the [Damping Control] menu press the <Right Arrow> and move the cursor down to [Time Average].
3. To enable Time Average entry press <Right Arrow>.

Siemens	Dual Path [1]	Path 1
Select SmartSlew or TimeAvg Damp		
Damping Control	Time Average	
Deadband Control	0.00	
Memory/Fault Set	Memory	
Memory Delay <s>	120	
Operation Adjust		

4. Use the numeric keys to type the new Time Average setting.
5. To register the new value press <ENT>.

Setting SmartSlew :

1. From the [Dual Path Flow] menu scroll to the [Operation Adjust] menu and press <Right Arrow>.
2. At the [Damping Control] menu press the <Right Arrow> and move the cursor down to [SmartSlew].
3. To access SmartSlew option list press <Right Arrow>.
4. Scroll the numeric list to the desired choice by pressing <Up/Down Arrow>.
5. To register the new value press <ENT>.

Deadband Control

Use the Deadband Control to instruct the flowmeter to report zero flow if the flow rate falls below a specified level (usually a very low rate). It will prevent the possibility of data scatter (a natural result of digital computation) from causing false Totalizer accumulation during long non-flowing periods. Inspect the actual data scatter during zero flow conditions to find the proper Deadband setting for your application.

To edit Deadband default setting (0.000):

1. From the [Dual Path Flow] menu scroll to the [Operation Adjust] menu and press <Right Arrow>.
2. Scroll to the [Deadband Control] menu
3. Press <Right Arrow> to enable numeric entry.
4. Use the numeric keys to type in the desired rate (using selected flow rate units).
5. To register the new value press <ENT>.

Memory/Fault Set

Certain situations will interrupt data production (e.g., an empty pipe or excessive aeration). Use Memory/Fault Set to select the flowmeter response to such an interruption. The Fault setting (default) will zero the flow rate output and declare an alarm on a flow display screen, Datalogger report and an assigned relay output.

For some applications, occasional temporary Fault conditions may be a normal part of the process and would not require an alarm response. The flowmeter offers a Memory operating mode to support such an application. Memory Mode suspends the flowmeter Fault response by preventing the flow outputs from dropping to zero for the interval specified in the Memory Delay menu cell. During the Memory duration, the flowmeter will maintain the last valid flow reading measured before the onset of the fault condition. The default Memory Delay is 60 seconds. You may select any duration from 3 to 604,800 seconds (one week).

Selecting Memory Mode

1. From the [Dual Path Flow] menu scroll to the [Operation Adjust] menu and press <Right Arrow>.
2. Scroll to the [Memory/Fault Set] and press <Right Arrow> to access option list.
3. Move the cursor down to [Memory] by pressing <Up/Down Arrow>.
4. To make selection press <ENT>.
5. This moves the highlight to [Memory Delay <s>].

Memory Delay (s)

Selecting [Memory Delay <s>] activates the suppressed [Memory Delay] menu cell. It allows you to specify the number of seconds that the flowmeter maintains its last valid flow reading. When the memory delay expires, it triggers the fault alarm response described previously.

Setting Memory Delay

1. To enable numeric entry press <Right Arrow>.
2. Use the number keys to type the delay in seconds.
3. To register the new value press <ENT>.

9.4 Setting Relays

Relay Functions

Use the [Relay Setup] menu to assign a function to channel relays. The flowmeter supports two types of relay outputs, Alarm Relay and Pulse Relay. Alarm Relay outputs operate in "fail-safe" mode. The relay(s) are energized under normal conditions - an alarm condition causes the relay(s) to de-energize until the alarm clears. The Pulse Relay output supports Totalizer and batch relay functions, with an output pulse width of approximately 200 ms; maximum activation rate is 2.5 pulses per sec. If Totalizer pulses exceed this rate, excess pulses are stored in an overflow register. This allows the relay to "catch up" when flow decreases enough.

Note

Using the <F1> key (Totalizer clear command) also clears all channel Totalizers plus the overflow register described in the last paragraph.

Relay 1, 2, 3, and 4 Function Assignments

The flowmeter, depending upon the model, provides four alarm relays. Please refer to the Appendix A for wiring details. Relays respond to any of the alarm conditions or data functions included on the Relay Option List.

Table 9- 7 Relay Option List

Not Used	Not Active
Power Off	Power Off alarm occurs when power fails.
S S.G.	Specific Gravity value relay trip-point.
S Base S.G.	S.G. value relay trip-point at reference temperature.
S High Visc	Kinematic viscosity (centistokes) exceeds High Setpoint.
S Low Visc	Kinematic viscosity (centistokes) falls below Low Setpoint.
S High Temp.	High temperature value relay trip-point.
S Low Temp.	Low temperature value relay trip-point.
S High Flow	Flow rate exceeds high flow set point.
S Low Flow	Flow rate falls below low flow set point.
S Flow Alarm	Flow rate exceeds or falls below flow set points.
S Fault Alarm	Loses receive signal (all paths in fault).
S Spacing	Sensor spacing needs adjusting.
S Turbulence	Turbulence percentage exceeds alarm set point.
S Interface	Interface set point exceeded.
S Reverse Flow	Flow is in negative direction.
S BatchTot	Batch/Sample total advances.
S Pos Total	Positive total volume advances 1 digit.
S Neg Total	Negative total volume advances 1 digit.
S Fltwarn	Fault warning occurs when 1 or more paths are in fault.
S Soft Fault	Fault condition - Memory mode active.
4 Fault Alarm	Loses receive signal (all paths in fault).
4 Spacing	Sensor spacing needs adjusting.
4 Turbulence	Turbulence percentage exceeds alarm set point.
3 Fault Alarm	Loses receive signal (all paths in fault).
3 Spacing	Sensor spacing needs adjusting.
3 Turbulence	Turbulence percentage exceeds alarm set point.
2 Fault Alarm	Loses receive signal (all paths in fault).
2 Spacing	Sensor spacing needs adjusting.
2 Turbulence	Turbulence percentage exceeds alarm set point.
1 Fault Alarm	Loses receive signal (all paths in fault).
1 Spacing	Sensor spacing needs adjusting.
1 Turbulence	Turbulence percentage exceeds alarm set point.

Note

For Multi-Path flowmeters: "1" = Path 1, "2" = Path 2, "3" = Path 3, "4" = Path 4 and "S" represents the system or average channel. These characters appear to the left of the option list parameter.

Assigning functions to Relay 1:

1. From the [Dual Path Flow] menu scroll down and highlight [I/O Data Control].
2. Press <Right Arrow> and scroll down to [Relay Setup].

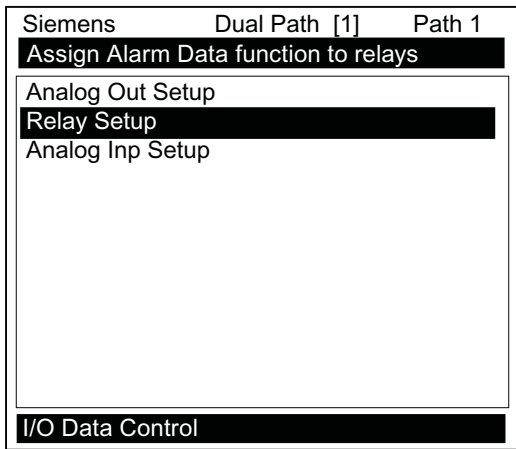

3. To access the [Relay Setup] option list press <Right Arrow>.
4. Move the cursor to the desired Relay assignment by pressing <Up/Down Arrow>.

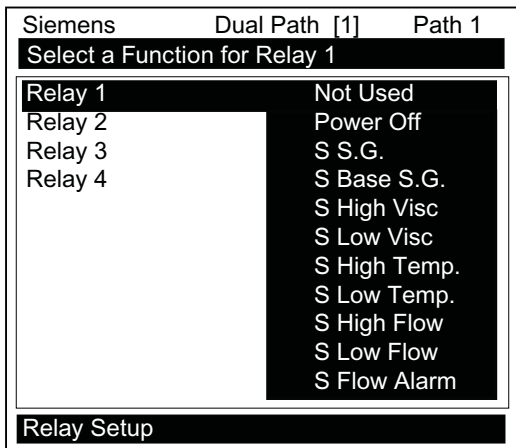

5. To store selection press <ENT>. Repeat procedure for all other relays.

9.5 Memory Control

Introduction

Memory Control is a reference menu that shows the amount of bytes of data memory left. The data memory capacity depends on the number and complexity of the site setups stored in memory and the size of the current Datalogger file.

The [Memory Control] menu is located in the [Meter Facilities] menu.

Table 9- 8 Memory Control Menu

Log Memory Left→	XXXXXXXX
Memory Map→	No Yes
Defragment→	No Yes

Log Memory Left

This view only menu cell shows the minimum remaining number of characters available for Datalogger and site storage. When the Datalogger is enabled for circular mode, the meter allocates all memory left except for two conventional empty sites required for Datalogger use.

To view the amount of data memory bytes available press <Right Arrow>.

Memory Map

Selecting YES for this item enables a snapshot display of current memory usage. In this display, the asterisk indicates a used block, a space indicates a free block, while a dash character indicates unused filler.

Defragment

Selecting YES for this item consolidates memory data blocks into contiguous storage; collapsing the filler regions. You may be able to use an additional block for site or Datalogger storage as a result. Use this command if you seem to be out of memory even though the [Log Memory Left] item indicates free capacity.

9.6 Analog Output Trim

Introduction

Analog Out Trim function allows you to fine-tune the flow meter’s analog voltage and current outputs using an ammeter connected to the output under test. In addition, you can use a frequency counter to fine-tune the flow meter’s pulse rate output.

Note

The current, voltage, and Pgen trimming will be limited by the 12-bit resolution of the flow meter’s D/A Convertor (DAC).

1. From the [Meter Facilities] menu, scroll to the [Analog Out Trim] menu.
2. Press the <Right Arrow> to access the option list.

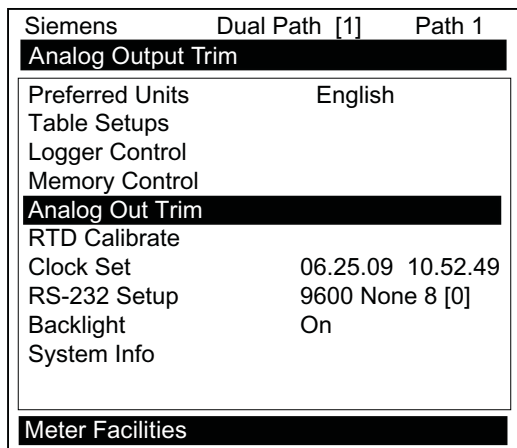

Table 9- 9 Analog Out Trim Menu Structure

Analog Out Trim	Io1/Io2	Operate Trim@	4mA Indicated mA = x.xx
	Vo1/Vo2	Operate Trim@	2V Indicated V = x.xx
	Pgen1 and Pgen2	Operate Trim @ 1kHz	Indicated Hz = xxx

Current Output Trim (Io1 & Io2)

Note

Can be trimmed to within .005 mA of nominal.

To calculate a current output:

1. Set up an ammeter, then connect it to the supply and return terminals of the current output under test.
2. Move the highlight to the port to be tested by pressing the <Up/Down Arrow>. Press the <Right Arrow> and then press the <Down Arrow> to move the cursor to [Trim @ 4mA].

Siemens	Dual Path [1]	Path 1
Trim 4-20 mA output		
Trim Io1	>Operate	
Trim Io2	Trim @ 4mA	
Trim Vo1	Operate	
Trim Vo2	Operate	
Analog Out Trim		

3. Press <ENT>. This triggers a 4.00 mA pop-up window. The ammeter should now be reading 4.00 mA.
4. If the ammeter reading does not match, use the numeric keys to type in the current reading.
5. Press <ENT> to register setting. This adjusts the flow meter's DAC (digital-to-analog converter) so that a 4mA output corresponds with 4mA on the ammeter.
6. Re-check the ammeter to make sure that it is now reading 4mA.

Voltage Output Trim (Vo1 & Vo2)

Note

Can be trimmed to within .0025 V of nominal.

To calculate a voltage output:

1. Set up a multimeter to read volts, then connect it to the supply and return terminals of the voltage output under test.
2. Move the highlight to the port to be tested by pressing the <Up/Down Arrow>. Then press the <Right Arrow> and then press <Down Arrow> to move the cursor to [Trim @ 2V].

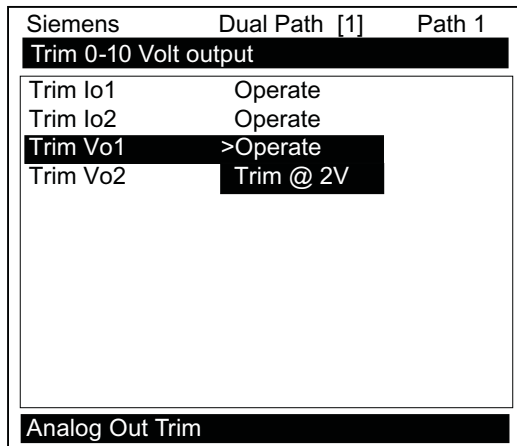

3. Press <ENT>. This triggers a 2.00 Volts pop-up window. The multimeter should now be reading 2.00 Volts.
4. If the multimeter reading does not match, use the numeric keys to type in the voltage reading.
5. Press <ENT> to register setting. This adjusts the flow meter's DAC (digital-to-analog converter) so that a 2.00 Volts output corresponds with 2.00 Volts on the multimeter.
6. Re-check the multimeter to make sure that it is now reading 2.00 Volts.

Pgen Output Trim (Pgen1 & Pgen2)

Note

Can be trimmed to within 1.25 Hz of nominal

To calibrate a pulse rate output (Pgen1 or Pgen2):

1. Connect a frequency counter to the supply and return terminals of the pulse rate output under test.
2. Move the highlight to the port to be tested, press the <Right Arrow> and then press the <Down Arrow> to move the cursor to [Trim @1 kHz].

Siemens	Dual Path [1]	Path 1
Trim 0 to 5 kHz output		
Trim Io1	Operate	
Trim Io2	Operate	
Trim Vo1	Operate	
Trim Vo2	Operate	
Pgen1	>Operate	
Pgen2	Trim @ 1 kHz	
Analog Out Trim		

3. Press [ENT]. This triggers a 1 kHz pop-up window. The frequency counter should now read 1 kHz.
4. If the frequency counter reading does not match, use the numeric keys to type in the frequency counter reading.
5. Press [ENT] to register setting. This adjusts the flow meter's DAC (digital-to analog converter) so that a 1 kHz output corresponds with 1 kHz on the frequency counter.
6. Recheck the frequency counter to make sure that it is now reading 1 kHz.

9.7 Resistive Temperature Device (RTD) Calibration

The [RTD Calibrate] menu appears on all SITRANS 1010 models. Use this menu to calibrate Temperature Sensors to an external standard. It is important to note that Siemens RTD temperature sensors are factory-calibrated for high accuracy. We recommend that before deciding to perform the calibration, check the current RTD reading in the [Diagnostics Data / Gas Data] menu. You may find that you do not need to calibrate the sensor. In any case, make sure that the temperature reading stabilizes before proceeding further. The [RTD Calibrate] menu allows you to perform an external calibration, which can be accomplished either by data entry of the current RTD temperature or by a 0°C (32°F) Ice-Bath procedure. You can switch between the intrinsic and external calibration modes at any time.

Note

If you perform an external temperature calibration, you should mark and record the location of each connector and sensor-cable. Once you have re-calibrated the temperature sensors, changing the sensor/connector orientation established during the procedure may void the calibration.

1. From the [Meter Facilities] menu scroll to the [RTD Calibrate] menu.
2. To access the [RTD Calibrate] menu press <Right Arrow>.

Siemens	Dual Path [1]	Path 1
Calibrate Temperature Sensors		
Preferred Units	English	
Table Setups		
Logger Control		
Memory Control		
Analog Out Trim		
RTD Calibrate		
Clock Set	06.25.09	10.52.49
RS-232 Setup	9600	None 8 [0]
Backlight	On	
System Info		
Meter Facilities		

Table 9- 10 RTD Calibrate Menu Structure

RTD Calibrate	RTD 1→	Factory User Cal
	RTD 2→	Factory User Cal

RTD Calibration by Entry Data

The [RTD Calibrate] menu allows you to adjust the intrinsic RTD reading to match an external reference thermometer by directly entering its reading. Only perform this procedure while the RTD under test is installed and currently measuring temperature.

To enter the current RTD temperature:

1. From the [RTD Calibrate] menu press <Right Arrow> to access the RTD option list.
2. Press <Right Arrow> to highlight the RTD you want to calibrate (RTD 1 or RTD 2).
3. Move the highlight to [Factory] or [User Cal] then press <ENT>.

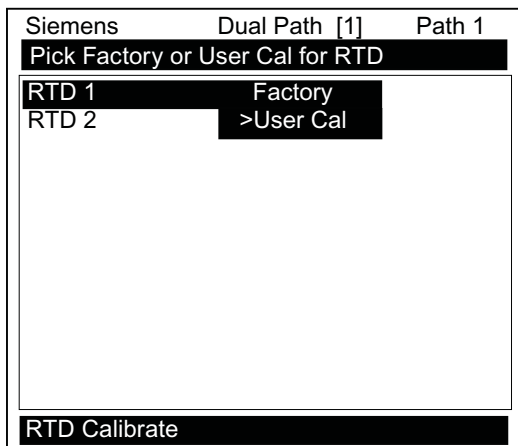

4. This triggers the pop-up window:

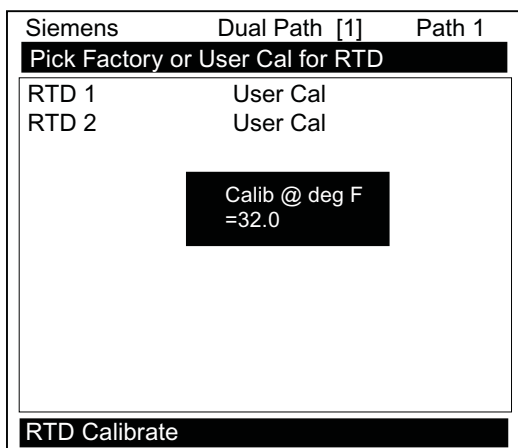

5. To enable numeric entry <Right Arrow>, then type in the reading of the reference thermometer (e.g., 72.0).
6. To recalibrate the RTD sensor <ENT>. To verify the calibrated reading, go to the Dual Path Flow menu [Diagnostic Data/Gas Data] menu to check the current RTD output. Make sure that it coincides with the gas reading of the reference thermometer. Repeat for the other RTD, if necessary.

Note

Factory Calibration provides an additional prompt after a new temperature is entered: [Are you Sure? No Yes]. It is recommended that you use [User Cal] to avoid alteration of preset factory calibration.

Ice Bath RTD Calibration

Use deionized water and ice mixture at 0°C (32°F) equilibrium for an ice bath. Ensure temperature with a reference thermometer. Siemens can not assume responsibility for the incorrect design, construction or operation of an Ice Bath.

 CAUTION
Do not allow an RTD sensor to make direct contact with ice during an ice bath calibration procedure.

To perform a 0°C (32°F) calibration:

1. Immerse RTD sensor in deionized water and ice mixture. Stir the mixture constantly.
2. In the [RTD Calibrate] menu move the highlight by pressing the <Up/down Arrow> to the RTD you want to calibrate (RTD 1 or RTD 2).
3. To access the RTD option list press <Right Arrow>. Move the highlight to [User Cal] then press <ENT>. This triggers the pop-up window.
4. After the RTD sensor reaches equilibrium at 0°C (32°F), press <ENT> to recalibrate the RTD sensor.
5. To verify the calibrated reading, go to Dual Path Flow [Diagnostic Data/Gas Data] menu to check the current RTD output. Make sure that it coincides with the gas reading of the reference thermometer. Repeat for the other RTD, if necessary.

Alarm, error, and system messages

10.1 Alarm Letter Codes and Descriptions

The following alarm codes appear on the main display of the flowmeter.

Table 10- 1 Alarm Codes and Descriptions

Letter Codes	Alarm Code	Description
S SPACE	Spacing	Sensor spacing may need adjustment
R HI/LO	Rate	Flow above High setting or below Low setting
F FAULT	Fault	Three continuous seconds without new data update
T TURB	Turbulence	Current turbulence percentage exceeds the alarm set point
M MEMRY	Memory	Last valid reading for a selected interval during Fault condition
K MAKUP	Makeup	In-Process Makeup occurred
The following alarm codes appear in the Datalogger status messages:		
I	Vs Interface	Gas Vs exceeds Vs Interface setpoint
Z	ZeroMatic	ZeroMatic signal fault

The displays shown below indicate where the Alarm Codes appear on the screen. Press <UP> or <DOWN> Arrows to change screen views.

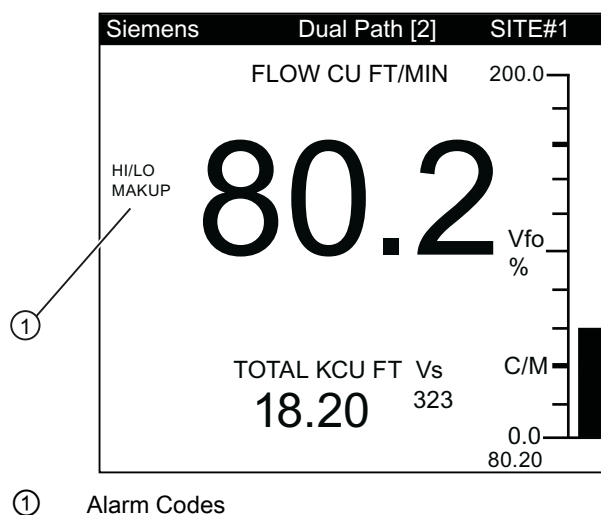

10.1 Alarm Letter Codes and Descriptions

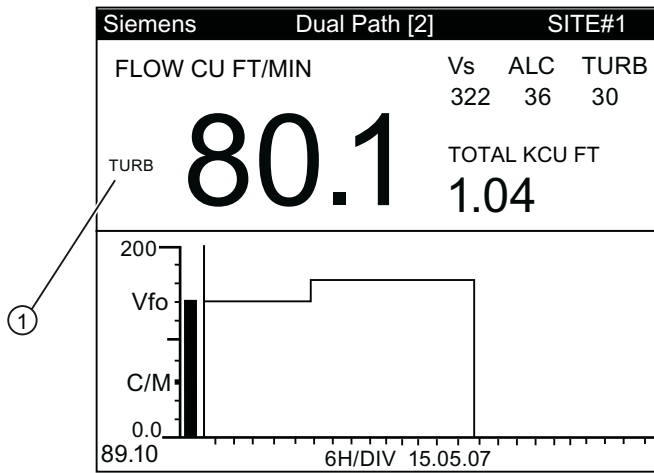

① Alarm Codes

Maintenance and service

11.1 Maintenance

The device is maintenance-free, however, a periodic inspection is recommended.

An inspection can include check of:

- Integrity of the wire connections, cable entries, and cover screws
- Verifying sufficient coupling compound between sensor and pipe
- Rechecking of sensor installation, integrity and mounting assembly is tight and secure

11.2 Technical support

If you have any technical questions about the device described in these Operating Instructions and do not find the right answers, you can contact Technical Support:

- Via the Internet using the **Support Request:**
Support request (<http://www.siemens.com/automation/support-request>)
- Via Phone:
 - Europe: +49 (0)911 895 7222
 - America: +1 423 262 5710
 - Asia-Pacific: +86 10 6475 7575

Further information about our technical support is available in the Internet at Technical support (<http://support.automation.siemens.com/WWW/view/en/16604318>)

Service & Support on the Internet

In addition to our documentation, we offer a comprehensive knowledge base online on the Internet at:

Service and support (<http://www.siemens.com/automation/service&support>)

There you will find:

- The latest product information, FAQs, downloads, tips and tricks.
- Our newsletter, providing you with the latest information about your products.
- A Knowledge Manager to find the right documents for you.
- Our bulletin board, where users and specialists share their knowledge worldwide.
- You can find your local contact partner for Industry Automation and Drives Technologies in our partner database.
- Information about field service, repairs, spare parts and lots more under "Services."

Additional Support

Please contact your local Siemens representative and offices if you have additional questions about the device

Find your contact partner at:

Local contact person (<http://www.automation.siemens.com/partner>)

11.3 Return procedures

Enclose the delivery note, the cover note for return delivery together with the declaration of decontamination form outside of the packing in a well-fastened clear, document pouch.

Required forms

- **Delivery Note**

- **Cover Note for Return Delivery** with the following information

Return delivery form (<http://support.automation.siemens.com/WW/view/en/16604370>)

- Type (ordering number)
- amount of devices or spare parts returned
- reason for the return

- **Declaration of Decontamination**

Decontamination declaration

(http://pia.khe.siemens.com/efiles/feldg/files/Service/declaration_of_decontamination_en.pdf)

With this declaration you certify "that the returned products/spare parts have been carefully cleaned and are free from any residues."

If the device has been operated together with toxic, caustic, flammable or water-endangering products, you are requested to clean by rinsing or neutralizing, so that all cavities are free from such dangerous substances. Afterwards, check and ensure the cleaning.

We will not service a device or spare parts unless the declaration of decontamination confirms proper decontamination of the devices or spare part. Before proceeding further, shipments without a declaration of decontamination will be cleaned professionally at your expense.

You can find the forms on the Internet and also on the CD delivered with the device.

11.4

Battery disposal



In accordance with EU directive 2006/66/EC, batteries are not to be disposed of using municipal waste disposal services.

Waste industrial batteries are accepted back by Siemens or by the local Siemens representative. Please talk to your local Siemens contact (<http://www.siemens.com/automation/service&support>) or follow the return procedures of Siemens.

Troubleshooting/FAQs

12.1 Troubleshooting

The following is list of troubleshooting tips and messages that you may encounter. They include explanations and, in some cases, a recommended action. If a problem seems unsolvable, contact your local Siemens office or regional Ultrasonic Flow Representative for expert help at: <http://www.automation.siemens.com/partner>.

Table 12- 1 Troubleshooting Tips

Message	Description
Memory Full!	Response to an attempt to save site data, when data memory is full. Delete an obsolete site or clear Datalogger memory to make room for the new data.
Memory Corrupted!	Memory read error occurred while accessing the active site data.
Chan Not Setup	Response to an attempt to invoke an operation that requires a channel to be enabled. Enable the channel [Channel Setup - Channel Enable - Yes]. Note that a channel cannot be enabled until its sensors are operating.
Clr Active Memory?	Response to pressing the F4 key. Use the F4 function to restore operation if a severe event (e.g., a violent power surge) disrupts system operation.
Clr Saved Data?	[Clr Saved Data?] only appears after answering No to [Clr Active Memory?]. Answering Yes to [Clr Saved Data?] will erase ALL saved data.
<EOT>	Response to a request to output Datalogger data to the printer or the Graphics screen when no Datalogger data exists. Set up the Datalogger.
No Sites - Press <ENT>	Response while trying to recall/delete a site setup when no sites are stored.
Invalid Setup	<p>During the Initial Makeup the system detects invalid transducer spacing, erroneous pipe parameters, or some other factor that prevents it from completing the Initial Makeup. This may be due to one of the following:</p> <ul style="list-style-type: none"> • An out-of-range data entry. • An invalid condition (e.g., overlapping sensors in Reflect Mode). Review all site setup and sensor installation choices particularly data entered for pipe and gas. • In Reflect Mode the flowmeter detects that the pipe wall signal may infringe upon the gas signal. • Press <ENT>, <Up Arrow>, <Down Arrow>, or <Left Arrow> to abort install routine. Continue programming other site data in anticipation of resolving the difficulty later. Call technical support for help if necessary.

Message	Description
Low Signal - Press <ENT>	<p>During the Initial Makeup the flowmeter decides that the level of the receive signal is insufficient for proper operation. Some reasons for low signal are:</p> <ul style="list-style-type: none"> • Invoking [Install Complete] on an empty pipe. • Coupling compound insufficient; not applied or evaporated. • A disconnected or broken sensor cable. • The pipe needs to be conditioned at the mounting location. • Insure that line is sufficiently pressurized. • The transducer cables are defective or not connected to the correct channel. <p>If you locate and correct the improper condition immediately, press <ENT> to resume the installation procedure. Otherwise, press the <Left Arrow> to abort the installation and conduct a thorough investigation.</p>
Detection Fault	<p>If it appears that the flowmeter cannot complete an Initial Makeup it means that the pipe and/or gas conditions do not permit a receive signal that meets the flow detection standards. The system will not operate. Attempt to improve operating conditions by reinstalling the sensors at a different spacing offset, or even at a different location on the pipe.</p>

Note

If you receive a Detection Fault message, it is strongly recommended that the Technical Service Department (<http://www.automation.siemens.com/partner>) be contacted.

12.2 F4 Reset Procedure

You may encounter an operating problem that blocks access to the Diagnostics Menu, or the flowmeter may operate erratically after exposure to a power transient or some other traumatic event. These cases may require use of the F4-reset sequence to restore operation.

The F4-Reset sequence operates on two levels:

- Clear Active Memory

The first F4-Reset deletes all the data currently in Active Memory, but leaves Datalogger data and all stored Site Setups intact. This is the most desirable method since all you have to do to restore operation is reload a saved Site Setup.

- Clear All Saved Memory

If the first sequence fails then you have to resort to the second level of the F4 sequence, which allows you to clear ALL Saved Memory. **Be aware that this erases all saved Site Setups (including flow calibrated sites), Datalogger Data and user-defined pipe and sensor tables.** This will require you to completely re-install the system and repeat all desired default settings, custom pipe tables, etc. The table below shows the sequence of the [F4] routine:

[Power On/Off + F4]⇒	[Clr Active Memory?]⇒ ↑ ↓	⇒No ⇒Yes
	[Clr Saved Data?]⇒	⇒No ⇒Yes

Clearing only Active Memory

1. Turn off power (if it is currently on). Press <F4> and keep it pressed while you turn on power. The prompt: [Clr Active Memory? No] appears at the top of the screen.
2. Press <Right Arrow> to access F4 Reset option list. Press <Down Arrow> to switch the option list to [Clr Active Memory? Yes]. Press <ENT> to clear all Active Site Data (but not saved Site Setups).
3. To restore operation, press <MENU> to access the installation menu. Create a new site setup or recall a stored site setup.
4. Re-select any Meter Facilities menu items (e.g. RS-232 setup parameters).

Clearing All Saved Data

1. Turn off power (if it is currently on).
2. Press <F4> and keep it pressed while you turn on power. The prompt: [Clr Active Memory? No] appears at the top of the screen. Press the <Down Arrow>. Note that the prompt switches to [Clr Saved Data? No].
3. To access the F4 Reset option list press the <Right Arrow>. Press the <Down Arrow> to switch the option list to [Clr Saved Data? Yes].

 CAUTION
<p>Before proceeding further it is essential to understand that this function eliminates ALL data stored in RAM. This means that all saved site setups including the site data of a flow-calibrated site will be erased! In addition, the entire Datalogger file plus any custom factory or user-created pipe or sensor tables will be eliminated. The impact of this is such that we strongly recommend that you consult Technical Services before continuing with this procedure. Be aware that you will have to create a new Site Setup, re-enter all site specific parameters including pipe or sensor tables, plus all desired Meter Facilities menu entries.</p>

4. To clear all Saved Memory press <ENT>.
5. Create a Site Setup before attempting to access other menu items.

12.3 Test Facilities Graph Screen

- 6. To restore operation, press <MENU> to access the installation menu. Create a new site setup and complete the installation procedure.
- 7. Re-select desired Meter Facilities menu items (e.g. RS-232 setup parameters).

12.3 Test Facilities Graph Screen

Test Facilities Graph Screen

When operating in the transit time mode the Test Facilities Graph Screen is an exceptional diagnostic tool for troubleshooting problem applications or simply determining Receive signal quality. The primary function of this screen is to display the digitized receive signal waveform with the similar appearance and function of a digital oscilloscope. This screen also allows the user to override some of the flowmeter default settings by permitting adjustment to the measured transit time, the digital averaging and the zero crossover used in the measurement of the up/down transit time difference. The figure shown below is a representation of the FUT1010 diagnostic graph.

Note

The Test Facilities Graphic Screen requires significant CPU overhead. The flowmeter should not be left in this mode during normal operation where the Datalogger is the primary output or during calibration work.

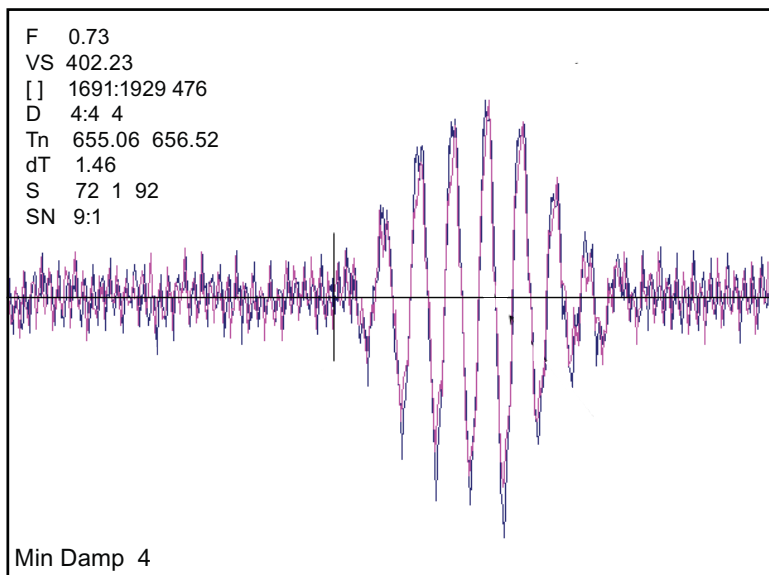

Figure 12-1 Test Facilities Graph Screen

Entering the Diagnostic Graph Screen

Before you can view the Diagnostic Graph Screen the flow channel must first be properly installed and operating in a non-empty condition. If a previously installed channel is in a "Fault" condition, but not reporting "Empty", you can still access the Graph Screen to aid in troubleshooting the cause of the failure to measure flow.

To view the Graph Screen first enter the [Test Facilities] menu, which is a submenu of the main [Diagnostic Data] menu.

1. Pressing the <Up/Down Arrows>, scroll to the [Graph] menu item.
2. Press the <Right Arrow> to enter the [Graph] menu and scroll to highlight the [Yes] item in the option list.
3. Now press the <ENTER> key to access the Graph Screen.
4. To exit the Graph Screen and return to the main menu, press the <MENU> key once.

Diagnostic Text Display

The text to the upper left-hand corner of the screen represents diagnostic items which can be individually turned on or off to reduce unnecessary clutter on the screen. This text display can be modified by pressing the <ENT> key and scrolling up or down through the various parameters that appear in the Graph Display menu. Pressing the <ENT> key will select the highlighted parameter (a "+" sign appears next to selected items) and pressing <CLR> will deselect the item. Pressing the <Left Arrow> will return you to the graph screen with the selected parameters appearing at the top left corner of the screen. (The sample graph above is shown with all diagnostics items selected).

Time Base Control

The digitized receive signal can be moved either to the left or right on the screen by pressing the <Left> or <Right> keypad arrows. The direction of the arrow actually represents the direction in which the Receive "window" will move, thereby causing the receive signal to shift in the opposite direction on the screen (e.g., Pressing the <Left Arrow> moves the signal to the right).

The digitized Receive signal can be expanded or contracted in the time domain by pressing the <+> or <-> keys on the keypad. This allows you to see the entire contents of the receive window, or zoom in to see greater detail. Pressing the <CLR> key once will automatically center the Receive signal on the screen. When expanding the Receive signal small vertical "tick" marks will eventually appear. These marks represent the time at which the Receive signal is digitally sampled.

Correlated Plot

During conditions of flow, the actual transit time delta (difference) can be observed in the displayed Receive signal waveform when the [Correlated Plot] menu parameter is not selected. To observe this time difference simply depress the <+> key (to see greater signal detail) until the individual up and down Receive signals are clearly discernible. To verify that the flowmeter signal processing algorithms are properly correlating the up and down stream Receive signals, select the [Correlated Plot] option from the display menu list.

Return to the graph screen and observe the relative position of the up and down waveforms. In a properly correlated Receive signal the two images should be nearly superimposed on top of each other, even during high flow conditions. In the unlikely situation where the two images appear to be offset by one or more receive cycles then the flow readings should be considered questionable.

Command Modes

Although the flowmeter signal processing algorithms are capable of accommodating a very wide range of signal conditions, it may be desirable to override these default settings under extremely difficult operating conditions. The following functions are available for this purpose.

Digital Damping Control: (Hot Key 1 and 2)

The meter permits user modification of the digital averaging used by the signal processing routines. In general, the default damping values selected by the flowmeter will provide optimal performance over a wide range of transit time applications. However, in extreme cases of unstable flow, pulsating flow, low signal levels or high electronic noise it may be necessary to override these default settings to permit uninterrupted and reliable flow measurement.

Test Facilities Graph Screen

The Graph Screen includes the capability to access a set of command codes, which enable a user to override a number of default meter settings. The most important parameter is the digital damping control, which can be accessed by pressing number <1> or <2> on the keypad while in the Signal Graph Screen mode.

[MinDamp #] Command

Pressing the <1> key will cause [MinDamp #] to appear on the command line at the lower left-hand corner of the screen. The number listed to the right of the command code represents the exponent in the meter exponential averaging routine, where the larger the number the greater the digital averaging. Pressing the <+> key will increase the damping value. Likewise, pressing the <-> key will decrease the damping value.

To exit this mode, press the <0> key on the keypad.

[MaxDamp #] Command

Pressing the <2> key will bring up the [MaxDamp #] command. The function of this parameter is similar to the [MinDamp #] command described above; however, the two parameters interact in the following manner. The MinDamp value must not exceed the MaxDamp value, therefore increasing the MinDamp value above the previous MaxDamp value will set both parameters to the same value. In most cases, it is preferred that both damping parameters be set to the same value, however, in cases where rapid response to changes in gas sound velocity for flow rate is required, the two values may be set differently. In this situation the meter will use the MaxDamp value when conditions are stable, but then switch to a faster damping value (limited by MinDamp) when a significant change in sound velocity or flow rate is perceived.

To exit this mode, press the <0> key on the keypad.

To access the Digital Damping Control using the Test Facilities Graph Screen, proceed as follows:

Note

To use the Test Facilities Graph Screen you must have a working site.

To activate the Test Facilities Graph Screen:

1. In the main menu, scroll to the [Diagnostic Data] menu and select [Test Facilities].
2. Scroll down to [Graph], press the <Right Arrow> and highlight [Yes]. Press <ENT> to select.
3. The Test Facilities Graphic Screen will appear on the flowmeter display as shown below.

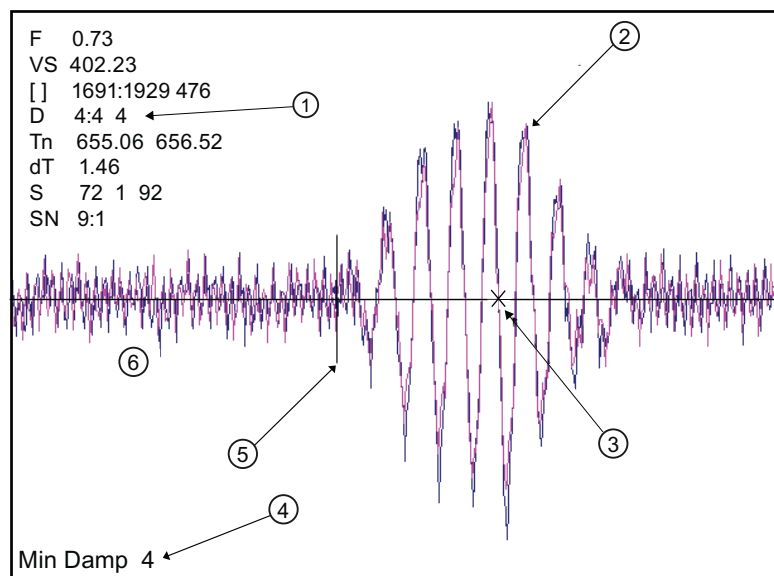

- | | |
|----------------------------|----------------------------------|
| ① Damping Factors | ④ Min Damping Factor (Hot Key 1) |
| ② Digitized Receive Signal | ⑤ TN Marker |
| ③ Crossover Marker | ⑥ High Baseline Noise |

Figure 12-2 Setting Digital Damping Factor

Setting the Digital Damping Factor to a value HIGHER than the default value of 4 may be necessary in cases where the signal-to-noise ratio (SN) is found to be unacceptably low (<15:1), but only if the noise is determined to be asynchronous (i.e., not associated with the transmit or flowmeter timing circuitry) as shown in the signal example above, where the baseline noise has a higher frequency than the true gas signal.

The following application conditions may require a higher Digital Damping Factor:

- Close proximity to pressure control valves which may generate in-band acoustic noise.
- Very low acoustic signal levels (ALC <40%).
- High electronic noise from variable frequency drives or other external equipment.

To INCREASE the Digital Damping:

1. Press the <1> key while viewing the Test Facilities Graph Screen as shown above. The damping control [MinDamp #] should appear on the command line at the lower left-hand corner of the screen.

Note

The number listed to the right of the command code on the screen represents the exponent in the exponential averaging digital damping routine, where the larger the number represents the greater the digital averaging. Setting this exponent higher than 7 is generally not recommended.

2. Pressing the <+> key will increase the MinDamp Factor by one unit for each key press.
3. To exit this mode, press the <0> key on the keypad.

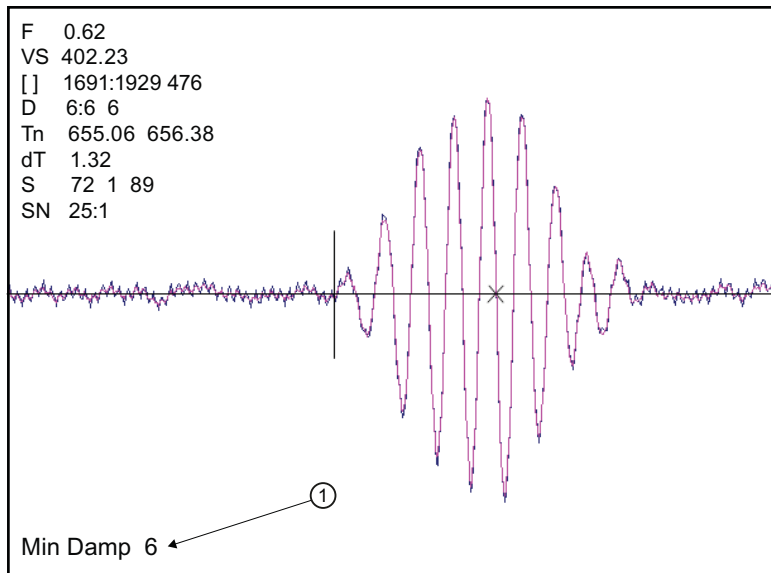

① Increased Damping Factor

Figure 12-3 Setting MinDamp Factor

The above example shows that increasing the Digital Damping reduces asynchronous noise.

Setting the Digital Damping factor to a value LOWER than the default value of 4 may be justified in cases where pulsating flow is present (such as from a reciprocating pump) or for the purpose of diagnosing transient signal behavior. A pulsating flow condition that generates more than +/- 45 degrees of phase jitter will generally cause signal correlation problems when any digital averaging is used. In this case it may be necessary to completely eliminate the digital averaging by reducing the Digital Damping Factor to 0. In such a case it may be necessary to install a narrow band tuned amplifier (Input Module) if too much asynchronous noise exists.

To DECREASE the Digital Damping:

1. Press the <2> key while viewing the Test Facilities Graph Screen. The damping control [MaxDamp #] will appear on the command line at the lower left-hand corner of the screen.
2. Pressing the <-> key will decrease the MaxDamp Factor by one unit for each key press.
3. To exit this mode, press the <0> key on the keypad.

Transit Time Adjustment: (Hot Key 3)

Observe the short vertical marker at the beginning of the receive signal in the Graph Screen above. This line represents the position in time (Tn) where the flowmeter perceives the arrival of the ultrasonic signal. There are actually two Tn markers, one for the upstream arrival time and one for the downstream arrival time. For proper gas sound velocity measurement these Tn markers should be positioned near the beginning edge of the receive waveform envelope (as shown), however, in cases of poor signal conditions it is possible for this measurement to be off by several receive waveform cycles.

1. To adjust the Tn mark position press the <3> key on the keypad to bring up the [TnSet] command.
2. Pressing the <+> or <-> keys will cause the Tn marker to move later or earlier, respectively. As you adjust the Tn marker, both Tn and Vs (gas sound velocity) will change accordingly.
3. To exit this mode, press the <0> key on the keypad.

Zero Crossover Adjustment: (Hot Key 4)

Observe the small "X" mark located on the zero crossing line near the middle of the Receive signal in the Graph Screen above. This "X" indicates the central crossover which the flowmeter is using to measure the transit-time delta. This crossover will generally be close to the peak of the Receive signal with at least one well formed (non-aberrated) receive cycle on each side of the crossover.

1. If it appears that the placement of this crossover is unsatisfactory then it can be adjusted by pressing the <4> key on the keypad, which will invoke the [ZCOSet #] command. The crossover point can then be moved in either direction on the waveform using the plus <+> or minus <-> keys. The change from the default value (in receive cycles) will appear in the number to the right of the command.
2. To exit this mode, press the <0> key.

Envelope threshold Adjustment: (Hot Key 5 & 6)

Pressing the <=> key causes the graph to toggle between the default signal waveform screen and the signal envelope screen (see example below). This envelope screen can aid in the diagnosis of Tn errors caused by unusual receive waveform distortion. Signal distortion is sometimes caused by poor transducer selection or poor pipe wall conditions, which may result in an incorrectly measured fluid sound velocity. To improve the automatic measurement of Tn, the envelope threshold limit can be adjusted to exclude portions of the envelope, which may be causing the Tn detection problem.

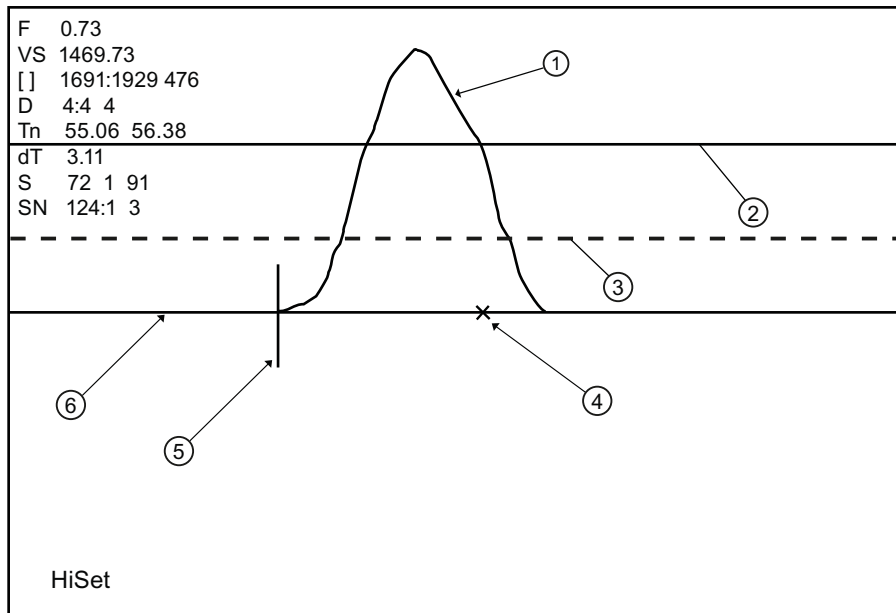

- ① Envelope Signal
- ② HiSet Envelope Threshold
- ③ LoSet Envelope Threshold
- ④ Crossover Marker
- ⑤ TN Marker
- ⑥ Zero Baseline

Figure 12-4 Envelope Threshold Adjustment

1. If it appears that the default placement of the Tn marker is incorrect or unstable, it can be adjusted by pressing the <5> key on the keypad to invoke the [Hi Set #] command or by pressing the <6> key to invoke the [Low Set #] command (while viewing the envelope screen). A horizontal line representing the envelope threshold level will appear along with a number indicating the percentage level. The High and Low thresholds can then be moved either up or down on the envelope using the <+> or <-> keys. While viewing the Tn marker position, adjust the thresholds so that they are well above the baseline "noise" level but below the first major peak.
2. To exit this mode, press the <0> key.

Signal Masking Function: (Hot Key 7)

Under conditions of extremely low signal amplitude, a noise spike associated with the flowmeter receive signal window may be present on the extreme left side of the graph display. If this spike is large enough it may interfere with the signal detection routines.

1. To eliminate this noise from the signal processing routines, press the <7> key to invoke the [MaskSet #] command, then press the <+> key until the noise is no longer present in the receive waveform.
2. Press <0> to exit this command.

Table 12- 2 Description of Graph Screen Text Display Parameters

Screen Text Parameters	Menu List Item	Description
F	Flow	Measured flow rate in selected flow units.
VS	Vs m/s	Sound Velocity in meters per second.
[]	Display Metrics	Represents the digital sample position of the receive window.
	Correlated plot	Displays the receive waveform in its proper superposition or registration. The true delta time will be displayed by NOT selecting "Correlated Plot".
	Centroid Mark	Indicates with a large vertical marker the peak energy of the receive waveform.
D	Damping	Displays the minimum and maximum digital damping exponent along with the active damping exponent.
Tn	Tn (usec)	Receive signal transit time in microseconds.
dT	DeltaT (nsecs)	Transit time delta (difference) in nanoseconds.
S	Signal Strength	Displays %Valc (amplitude), %Vaer (aeration factor) and numeric ALC.
SN	Signal-to-Noise Ratio	Indicates the signal-to-noise ratio of the receive signal. Increased damping will increase the S/N ratio as the asynchronous noise reduces.
	Envelope	Percentage change of the signal from Initial Makeup conditions.

12.3 Test Facilities Graph Screen

Table 12- 3 Hot Key Summary

Key	Command Line	Description
<+>		Expands (magnifies) waveform to view more detail.
<->		Contracts waveform to view more of the waveform.
<Left Arrow>		Shifts receive window to the left (waveform to the right).
<Right Arrow>		Shifts receive window to the right (waveform to the left).
<CLR>		Brings waveform to the center of the screen.
<ENTER>		Calls up Text Display menu items. <Left Arrow> to return to graph.
<MENU>		Exits the Graph Screen and returns to the main menu.
<1>	MinDamp	Minimum damping exponent control (+ or - to increase or decrease).
<2>	MaxDamp	Maximum damping exponent control (+ or - to increase or decrease).
<3>	TnSet	Transit time adjustment (use + or - to move Tn marker).
<4>	ZCOSet	Zero Crossover adjustment (use + or - to move crossover marker).
<5>	HiSet	Signal envelope threshold level (use + or - to move threshold).
<6>	LoSet	Signal envelope threshold level (use + or - to move threshold).
<7>	MaskSet	Leading edge masking functions (use + or - to alter number of samples masked).
<8>	Hold Set	Set this number higher if intermittent mis-registration occurs.
<0>		Exits the command line.
<=>		Toggle graph between receive waveform and envelope waveform.
<F1> and <.>		Dumps the digitized waveform data over the RS-232 port. You must first leave the Graph Screen mode before invoking this command.

This menu provides data pertaining to sensor characteristics and operation. Some menu items are for technical support interpretation only.

Siemens	Dual Path [1]	ABC
Current transmit drive code		
fx (drive)		30
N (burst length)		5
Ltn		-1.154
Vf max		1577.42
Vs max M/S		2165.41
Vs min M/S		939.62
Empty		30
Samples/Cycle		16
Max Damping		
Min Damping		
HF		0.120
Site Setup Data		

Table 12- 4 Site Setup Menu Items

fx Drive	Current Transmit drive code selected during Initial Makeup. The drive code controls the sonic transmit signal.
N (burst length)	Transmit burst duration selected during Initial Makeup. To change N count press <Right Arrow>. At equal sign enter numeric value (1 to 9 only).
Ltn (mm/in)	Spacing distance between the transducers. It will be in inches or millimeters, depending on default units.
Vf max	The flow velocity (in selected units) corresponding to one whole cycle offset between upstream and downstream receive signals.
Vs max M/S	Maximum Vs for current transducer spacing.
Vs min M/S	Minimum Vs for current transducer spacing.
Empty	Value of Empty Alarm Setting. The meter will declare an empty status if signal strength drops below this value.
Samples/Cycle	Digital sampling rate.
Max Damping	Maximum signal damping. Use to average digital data when an unstable condition occurs.
Min Damping	Minimum signal damping. Use to average digital data when an unstable condition occurs.
HF	Flow registration correction parameter.

[HF] Menu Item

The flowmeter includes a Diagnostics Menu item that permits the entry of a flow registration correction parameter labeled [HF]. This "HF" parameter is the input for a proprietary algorithm that automatically compensates for signal beam blowing, thereby extending the upper flow limit of the flowmeter. The HF parameter should only be adjusted in cases where the user suspects that extreme flow velocity or a large delta-time may be causing signal correlation problems.

Using the [HF] Menu Cell

Two methods for adjusting this parameter are provided via the [HF] menu cell, located within the [Diagnostics] / [Site Setup] submenu. The "Manual" method provides direct entry of this parameter and is primarily intended for the advanced user, whereas the "Automatic" method allows the flowmeter to automatically measure the required correction and install the parameter.

Guidelines for use

- This menu is only accessible for the sensor channels, not the virtual (average flow) channel of the flowmeter (i.e., Diagnostics Path 1 or Path 2, but not Path 1 & 2).
- The flowmeter will inhibit the "Automatic" installation of the [HF] parameter if the flow rate is insufficient (too low) to accurately measure the required correction. If the maximum flow rate for the application is relatively low then this correction is not be required.
- If the flow rate is very high and the flowmeter is reporting erroneous or unstable flow, then the flowmeter may already be having trouble resolving the upstream and downstream signals. In this event, it may be necessary to first lower the flow rate to a moderate level before performing the "Automatic" HF adjustment. Once this is done the flowmeter should be able to properly measure the highest flow rates without problems.
- The limits of the "HF" parameter are +/- 0.7 and any attempt to manually install a larger value will cause the flowmeter to abort the installation of the parameter.

Note

Pressing the <Left Arrow> at any stage prior to accepting the measured value will abort the installation and return to the previous setting.

Accessing the [HF] Function

1. At the [Meter Type] Menu, press the <Right Arrow> and then <ENT> to select the desired Path (e.g., Dual Path Flow).
2. In the [Dual Path Flow] Menu, press the <Down Arrow> and scroll to the [Diagnostic Data] menu cell. Press the <Right Arrow> to select it.
3. In the [Diagnostic Data] Menu, highlight [Path Select] and select the desired sensor path. Press <ENT> to select path.
4. Press the <Down Arrow> and scroll to the [Site Setup Data] menu cell. Press the <Right Arrow> to select it.

Manual Adjustment Procedure

1. In the [Site Setup Data] Menu, press the <Down Arrow> and scroll to the [HF] menu cell. Press the <Right Arrow> and a pop-up [Manual] prompt will appear as shown below.

Note

Press the <Up/Down Arrow> to select [Automatic], if desired.

2. Use the numerical keys to input the desired correction value. Press <ENT> to input value.

Siemens	Dual Path [1]	ABC
fx (drive)		29
N (burst length)		5
Ltn		5.136
Vf max	1577.4	Adjustment
Vs max M/S		>Manual 41
Vs min M/S		939.62
Empty		
Samples/Cycle		29
Max Damping		
Min Damping		
HF		>0.000
Site Setup Data		

Siemens	Dual Path [1]	ABC
fx (drive)		29
N (burst length)		5
Ltn		5.136
Vf max	1577.4	>Manual
Vs max M/S		= 0.120 41
Vs min M/S		939.62
Empty		
Samples/Cycle		29
Max Damping		
Min Damping		
HF		>0.000
Site Setup Data		

3. The new correction value will appear next to the [HF] menu cell as shown below.

Siemens	Dual Path [1]	ABC
fx (drive)		29
N (burst length)		5
Ltn		5.136
Vf max		
Vs max M/S		
Vs min M/S		1355.00
Empty		
Samples/Cycle		29
Max Damping		
Min Damping		
HF		>0.120

Automatic Adjustment Procedure

1. In the [Site Setup Data] Menu, press the <Down Arrow> and scroll to the [HF] menu cell. Press the <Right Arrow> and a pop-up [Manual] prompt will appear.
2. Press the <Up or Down Arrow> to select [Automatic] then press <ENT>.
3. The current measured correction value is displayed (see below).
4. Press <ENT> again to install this correction value which will now appear next to the [HF] menu cell.

Note

The value shown in the [Automatic] pop-up prompt can not be changed and is for user information only.

Siemens	Dual Path [1]	ABC
fx (drive)		29
N (burst length)		5
Ltn		5.136
Vf max	Adjustment	
Vs max M/S	>Automatic	
Vs min M/S		939.62
Empty		
Samples/Cycle		29
Max Damping		
Min Damping		
HF		>0.000
Site Setup Data		

Siemens	Dual Path [1]	ABC
fx (drive)		29
N (burst length)		5
Ltn		5.136
Vf max	>Automatic	
Vs max M/S	= 0.026	
Vs min M/S		939.62
Empty		
Samples/Cycle		29
Max Damping		
Min Damping		
HF		>0.026
Site Setup Data		

5. If you decide not to use the [Automatic] selection, press any key other than <ENT> to abort the operation.

Technical data

13.1 Technical Data

Transmitter

- Operating Temperature Range: -18°C to 60°C (0°F to 140°F)
- Storage Temperature Range: -20°C to 93°C (-4°F to 200°F)
- Degree of Protection: IP65 NEMA 4X

Sensor

Gas Min/Max Temperature

- -29°C to 93°C (-20°F to 200°F)

Maximum Pressure Rating

- 51 bar (740 psi) for class 300#
- 102 (1440 psi) for class 600#

Flange Rating

- Pressure number 50 (Class 300, raised face)
- Pressure number 100 (Class 600, raised face)

Gas Type

- Natural Gas (mostly CH₄)
- Process Gases (N₂, O₂, CO, Ar)
- Helium
- Hydrogen
- Other (Specify Gas composition with plain text)

Paint Specification

- Marine/Off Shore grade paint system, 3 parts urethane paint.

Torque Specification

- Junction Box bolts - 6.8 to 8.1 Nm (5 to 6 ft-lbs)

Unit Repair and Excluded Liability

All changes and repairs must be done by qualified personnel, applicable safety regulations must be followed. Please note the following:

- The user is responsible for all changes and repairs made to the device.
- All new components must be provided by Siemens Industry, Inc.
- Restrict repair to faulty components only.
- Do not re-use faulty components.

Appendix

A.1 Accessories and spare parts

In order to ensure that the ordering data you are using is not outdated, the latest ordering data is always available on the Internet: Catalog process instrumentation (<http://www.siemens.com/processinstrumentation/catalogs>)

See also

Process instrumentation catalog (<http://www.siemens.com/processinstrumentation/catalogs>)

A.2 I/O Connections and Wiring

Terminal Block Wiring - 7ME39400AL04 Expanded I/O Module

(Refer to manual drawing 1010N-7-7 sheet 2 of 2)

These connection diagrams apply to the part numbers listed below.

Table A- 1 Connection Diagrams and Part Numbers

1010N-7-7 (Sheet 2 of 2) Drawing	
FUT1010	7ME363*..**

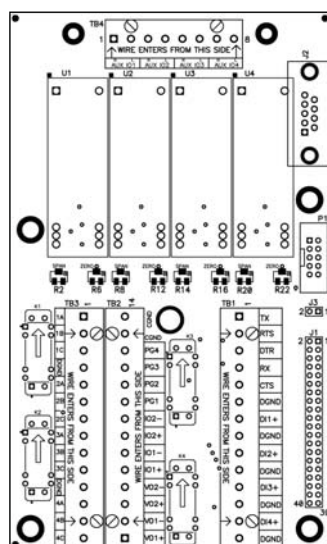

Figure A-1 7ME39400AL04 Expanded I/O Module

Table A- 2 Input/Output Wiring (TB2) - 7ME39400AL04 Expanded I/O Module

Pin#	Signal	Definition	Description	Function Dual/Quad Path Only
14		Chassis Ground	Chassis Ground	Cable Shield Terminations
13		Chassis Ground	Chassis Ground	Cable Shield Terminations
12	PG4	POS [+] Total TTL	0-5000 Hz frequency output , assignable	POS [+] Total TTL
11	PG3	POS [+] Total OC		POS [+] Total OC
10	PG2	NEG [-] Total TTL)		NEG [-] Total TTL
9	PG1	NEG [-] Total OC		NEG [-] Total OC
8	Io2 (-)	Isolated Return		Flowmeter process variables assigned to individual outputs under menu control.
7	Io2 (+)	4-20 mA Output 2		
6	Io1 (-)	Isolated Return		
5	Io1 (+)	4-20 mA Output 1		
4	Vo2-	Ref. Ground		
3	Vo2+	0 to 10 Volt Output		
2	Vo1-	Ref. Ground		
1	Vo1+	0 to 10 Volt Output		

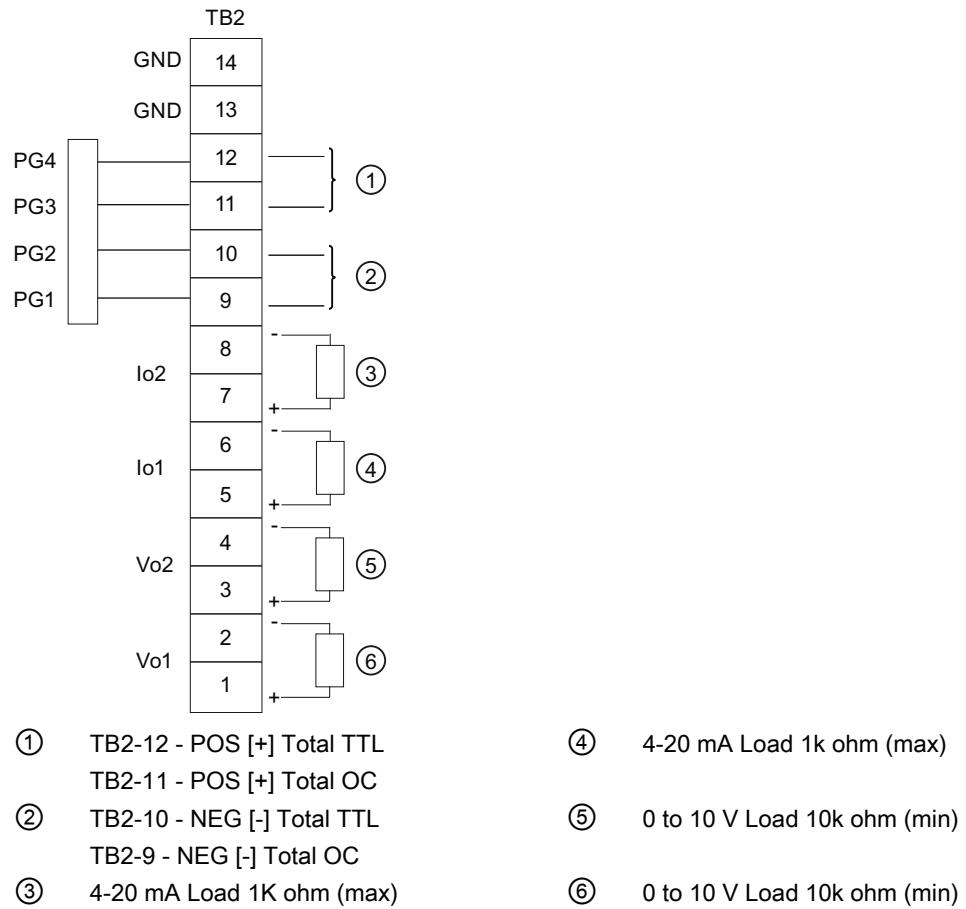

Figure A-2 7ME39400AL03 TB2 Expanded I/O Wiring

Table A- 3 Input/Output Wiring (TB3) - 7ME39400AL04 Expanded I/O Module

Pin#	Signal	Definition	Description	Function Dual Path Only	Function Quad Path Only
1	K1 A	Relay 1 Normally Open	Relay 1	Alarm or control functions set by CH 3.	Alarm or control functions set by CH5.
2	K1 B	Relay 1 Normally Closed (7ME39400AL04 only)			
3	K1 C	Relay 1 Common			
4	GND	Digital Return (GND)	DGND		
5	K2 A	Relay 2 Normally Open	Relay 2	Alarm or control functions set by CH 3.	Alarm or control functions set by CH5.
6	K2 B	Relay 2 Normally Closed (7ME39400AL04 only)			
7	K2 C	Relay 2 Common			
8	K3 A	Relay 3 Normally Open	Relay 3	Alarm or control functions set by CH 3.	Alarm or control functions set by CH5.
9	K3 B	Relay 3 Normally Closed (7ME39400AL04 only)			
10	K3 C	Relay 3 Common			
11	GND	Digital Return (GND)	DGND		
12	K4 A	Relay 4 Normally Open	Relay 4	Alarm or control functions set by CH 3.	Alarm or control functions set by CH5.
13	K4 B	Relay 4 Normally Closed (7ME39400AL04 only)			
14	K4 C	Relay 4 Common			

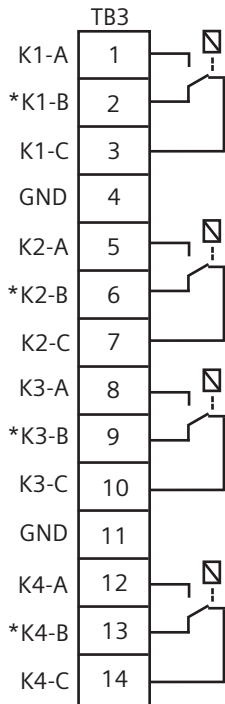

Figure A-3 7ME39400AL03 TB3 I/O Relay Wiring

Note

Relays shown in Power OFF position, which is the same as the alarm assertion position.

*7ME39400AL03 Mercury Relay only available with Normally Open.

Table A- 4 Input/Output Wiring (TB4) - 7ME39400AL04 Expanded I/O Module

Pin#	Signal	Definition	Description
1		No Connection	
2		No Connection	
3		No Connection	
4		No Connection	
5	AUX Io3+	Isolated Loop Power Io3	Connect +30 V max. Loop Supply here
6	AUX Io3-	Io3 4-20 mA Output	Vo1+ Data Presented as 4-20 mA
7	AUX Io4+	Isolated Loop Power Io4	Connect +30 V max. Loop Supply here
8	AUX Io4-	Io4 4-20 mA Output	Vo2+ Data Presented as 4-20 mA

Note

Auxiliary 4-20 mA loops are assigned and spanned under menu control of Vo and PGEN outputs.

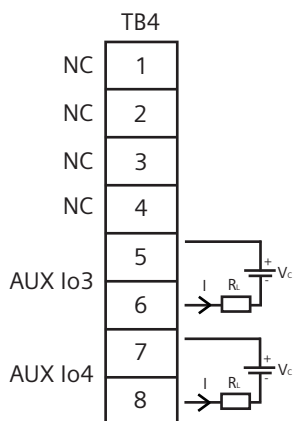

Figure A-4 7ME39400AL03 TB4 Expanded I/O Wiring

V_c: 24 VDC typical (+15 VDC to +30 VDC max) Loop Power

R: 1000 ohms (max), Loop wire resistance plus user's input load resistance

I: 4-20 mA

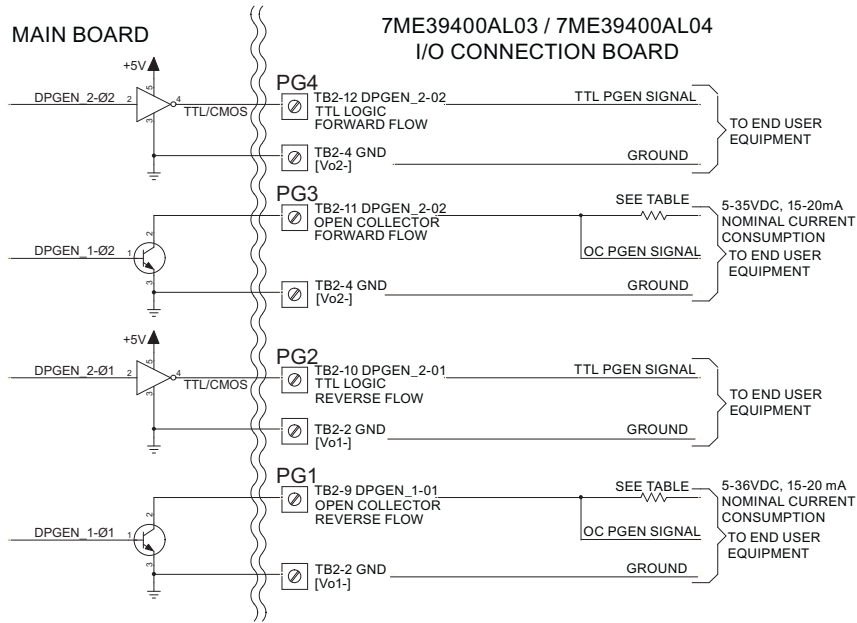

Figure A-5 7ME39400AL03 Main Board I/O Wiring

Table A-5 Open Collector User Resistor Recommendations

User Supply Voltage (VDC)	External Resistor (Ohms)	Expected Current Draw (mA)	Recommended Resistor Wattage (Watts)
5	270	18.5	1/2
9	510	17.6	1/2
12	680	17.6	1/2
18	1000	18	3/4
24	1500	16	1
28	1800	15.5	1 1/4
36	2400	15	1 1/4

Note

TB2-9 and TB2-11 are Open Collector Outputs that require external pull-up resistors for operation. See table for External Supply Voltage and suggested resistor value and ratings. Maximum current into the transistor is 100 mA. Maximum Voltage is +36 VDC.

CAUTION
Negative voltages with respect to ground will permanently damage transistors.

A.3 Site Setup For SITRANS F

How to use the Windows HyperTerminal Program

Windows provides a communication program called HyperTerminal, which is ideal for interfacing your computer with the flowmeter. The following typical example explains how to set up HyperTerminal.

Note

Depending upon the Windows applications being used this setup procedure may vary.

1. From the Windows desktop, left-click on the [START] button.
2. Holding down the left mouse button, move the highlight up to [Programs], then across to [Accessories] then [Communications]. Slide the highlight down to [HyperTerminal], then release the left mouse button.
3. Within the HyperTerminal window, move the mouse pointer down to [Hyperterm.exe] and then double-click the left mouse button.
4. This selects the [Connection Description] dialog box. Enter a name for your connection (e.g., 1010N). You can optionally select an icon for this connection by clicking on one of the icons displayed in the scrolling frame at the bottom of the window. Click [OK].
5. This selects the [Phone Number] dialog box. Move the cursor to the arrow at the right of the [Connect Using] field. Left click on the arrow to expand the field and then move the highlight down to [Direct to Com 1 (or 2)] depending on the port connected to the interface cable. Click [OK] to select the [Com 1 (or 2) Properties] Dialog box. Set up your RS-232 parameters as shown in the example below. Left-click on the [OK] button.

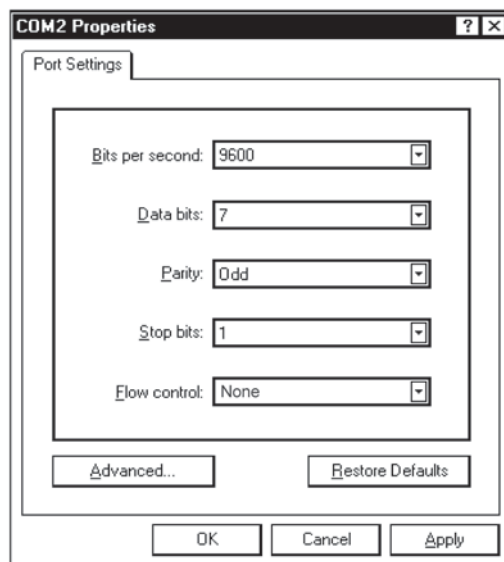

6. You will now see a blank terminal screen. Next left-click [File] on the top menu bar. Drag the highlight down to [Properties] and then left-click.

7. Left-click the [Settings] tab. Expand the [Emulation] box by left-clicking the <Down Arrow> on the right-hand side. Drag the highlight down to [VT-100] and then left-click to select it (as shown below).

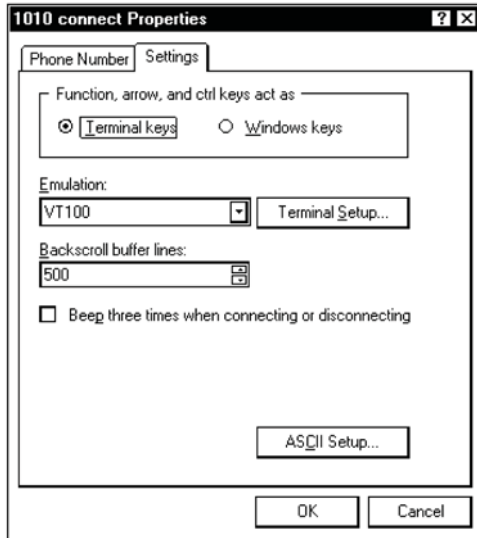

8. Next, left-click on the [ASCII Setup] button (see screen above). In the [ASCII Sending] dialog box, make sure that both [send line ends with line feeds] and [Echo Typed characters locally] are UNCHECKED. In the [ASCII Receiving] dialog box, left-click to place a check mark before the [Append line feeds to incoming line ends] dialog. When your screen looks like the example below, left-click the [OK] button.

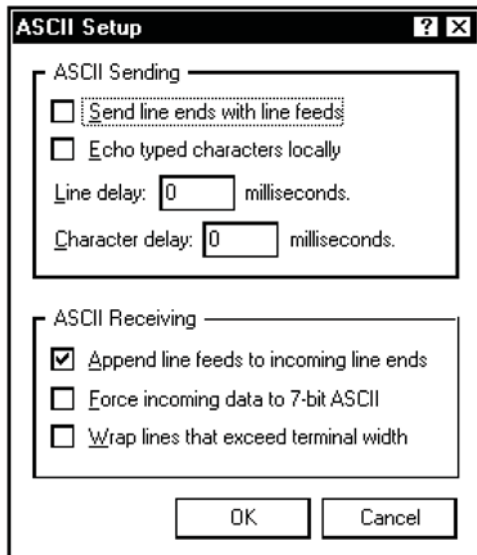

9. You are now ready to communicate with the 1010 flowmeter. But first, save your settings by moving the mouse cursor to [File], sliding the cursor to [Save], then clicking [OK] on the Save dialog box.
10. The next time you want to use HyperTerminal:
 - Click on Start.
 - Drag to Programs.

- Drag to Accessories. Drag to [Communications], and click.
- Double-click the icon you selected for the connection.

Note

For easier access, create a shortcut to the connect icon from your desktop. Right-click on the icon to open its dialog box. Left-click on [Copy] or [Create a Short Cut] and then move the mouse cursor to a blank area on your desktop. Right-click to open dialog box and then left-click on [Paste] to place a shortcut to the connect icon on your desktop.

Accessing the Installation Menu

Once the parameters are set, HyperTerminal automatically initiates Command mode. You will see a blank screen.

1. Press <Enter> a few times until you see [? For Help] on the screen.
2. Type: ? (question mark) and then press <Enter> to see a list of the available commands.

Use the MENU command (type [Menu] and then press <Enter>) to access the top level of the Installation Menu. You will see a screen similar to the example below.

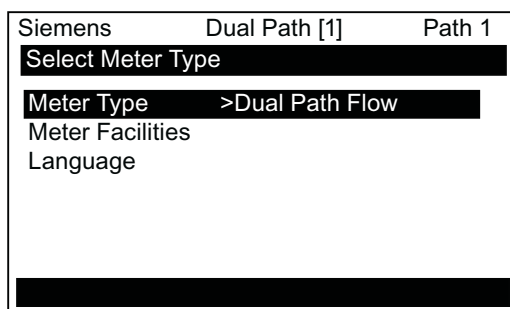

Note

To facilitate connecting through modems, the [Menu] command times out after three minutes of inactivity. To maintain a longer connection, type: Menu 1000 and press <Enter>. The optional number is the amount in minutes that the connection will be maintained. Typing [Menu 1000] essentially keeps the interface active until you cancel it.

Data Display Mode

After you complete the installation, you can toggle between Installation Menu mode to Data Display mode. This is the same as using the <MENU> key on the keypad. The PC keyboard equivalent to the <MENU> key is <Ctrl> + <L>. Note that the RS-232 interface does not support graphics. Therefore, when you use HyperTerminal to view the data display screens, you will see the same data in alphanumeric form only (as shown below). You can still use the <Up Arrow> and <Down Arrow> to switch between available display screens.

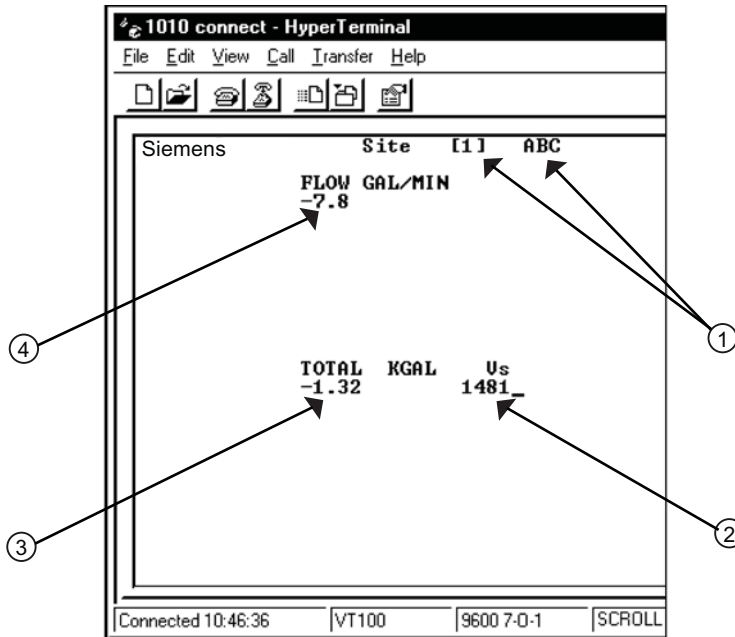

- ① Current active site setup name. The [1] indicates that the measurement channel is active.
- ② The current measured sonic velocity.
- ③ The flow Total display.
- ④ The current flow reading and flow units.

Navigating through the Installation Menu

After accessing the Installation Menu, you can begin to setup your flowmeter according to the instructions in this manual. The chart below shows the PC keyboard equivalents to the keypad keys while you are in the menu.

SITRANS F 1010 Keyboard	PC Keyboard	Description
<Up Arrow>	<Up Arrow>	Move up 1 menu cell (or Flow Display screen)
<Down Arrow>	<Down Arrow>	Move down 1 menu cell (or Flow Display screen)
<Right Arrow>	<Right Arrow>	Move right 1 menu cell (or Flow Display screen)
<Left Arrow>	<Left Arrow>	Move left 1 menu cell (or Flow Display screen)
<Menu>	^L (Ctrl L)	Toggle between Menu and Flow Display
<Datalog>	^D (Ctrl D)	Generate Datalogger report
<CLR>	<Backspace> or 	Deselect list selection
<ALT+Up Arrow>	^U (Ctrl U)	Logger Display Page Advance
<+/-> (chg sign)	(bar, shift + backslash)	Change numeric sign. Can also type (-) key
<ENT>	<Carriage Return>	Enter Key
Digits	Digits	Numerals 0 through 9
/	/	Divide by
X	* (shift + upper case 8)	Multiply by
+	+	Plus
-	-	Minus
=	=	Equals
.	.	Decimal Point

Terminal Mode Menu Commands

In addition to Menu, the following commands (followed by the <ENT> key) can be used to control the flowmeter while in Terminal Mode.

Note

The "n" refers to the flowmeter Channel number. For a dual channel Arithmetic site (Ch1 + Ch2 or Ch1 – Ch2) the virtual Channel is number 3.

Logger

Invokes the download of all data stored in the Datalogger. Note that the Datalogger data is not erased from the flowmeter memory when it is downloaded. It is recommended to capture this information into a file with a "csv" extension, which can be easily imported into MS EXCEL.

SITE

Invokes a full site download for a single channel or multi-path 1010 flowmeter.

SITE "n"

Invokes a site download for channel "n", where "n" = the Channel # (1, 2, 3, 4, etc.).

DP "n"

Commands the flowmeter to download the digitized receive signal data for Channel or Path "n".

CLRTOT

Clears the Totalizer for a single channel or multi-path 1010 flowmeter.

CLRTOT "n"

Clears the Totalizer for Channel "n" of a multi-channel flowmeter.

Lf on

Turns on the Line Feed at the end of any text string sent by the flowmeter.

Lf off

Turns off the Line Feed at the end of any text string sent by the flowmeter.

?

Provides a list of available Terminal Mode flowmeter commands.

Transferring information from a 1010 Flowmeter to the PC

With HyperTerminal active:

1. Point to [Transfers] and click.
2. Select [Capture Text].
3. Select desired drive path or directory, enter a file name, and click the Start button.
4. Use the following conventions for data file names:
 - For site data or wave shape data: filename.txt
 - For Datalogger data: filename.csv
5. On PC type the proper command for the data desired (Logger, Site, or DP) and then [Enter].
6. The data now begins streaming on the HyperTerminal screen.
7. Wait for EOT (End Of Transmission) to be displayed.
8. Close the file by pointing to [Transfer], drag to Capture Text and click Stop button.

Closing the Terminal or HyperTerminal Program

You may now close the Terminal program. The file(s) you have downloaded are now saved in the location you selected. You may now import the file you have saved into the appropriate program (i.e., MS Word for site data, or MS Excel for Datalogger or Wave shape data for graphing or analysis).

The Datalogger contains data that has its fields separated by commas. By using the file extension ".csv" (comma separated values) suggested earlier, the data will import directly into MS Excel without any further modification. For the wave shape data, the fields are separated by spaces, therefore, it is best to save those files as .txt and then use the MS Excel Import Wizard to select "Space Delimiters" for importation of the data.

Site data is downloaded in plain text and can be imported directly into MS Word.

To Clear Active Memory using the RS-232 Interface

1. Turn off power (if it is currently on). Turn power on. As soon as you apply power, immediately type the @ character three times. The prompt: **[Clr Active Memory? No]** appears at the top of the screen.
2. Press the <Right Arrow> and then the <Down Arrow> to switch the option list to: **[Clr Active Memory? Yes]** Press <Enter> to clear all Active Site Data (but not saved site setups).
3. To restore operation, press <MENU> to access the Installation Menu. Create a new site setup or recall a stored site setup. Re-select any Meter Facilities items (e.g., RS-232 setup parameters).

To Clear All Saved Memory using the RS-232 Interface

 **CAUTION**

Before proceeding further, it is essential to understand that this function eliminates all data stored in RAM. This means that all saved site setups, including the site data of a flow-calibrated site will be erased! Also, the entire Datalogger file plus any custom factory or user-created pipe or sensor tables will be eliminated. The impact of this is such that we strongly recommend that you consult our technical service department before continuing with this procedure. If you choose to continue, be aware that you will have to create a new site setup, re-enter all site specific parameters including pipe or sensor tables, plus all desired Meter Facilities entries.

1. Turn off power (if it is currently on).
2. Turn the power on. As soon as you apply power, type the @ character three times.
 - The prompt: **[Clr Active Memory?]** appears at the top of the screen. Press the <Down Arrow>.

Note

The prompt switches to **[Clr Saved Data? No]**.

3. Press the <Right Arrow> and then the <Down Arrow> to switch the option list to: **[Clr Saved Data? Yes]**.
4. Press <ENT> to clear all Saved Site Data, Datalogger Data, User created Pipe Data and Sensor Data.
5. To restore operation, press <MENU> to access the Installation Menu and create a new site setup. Reselect any Meter Facilities items (e.g., RS-232 setup parameters).

A.4 Flowrate Calibration and Calibration Tables

Flowrate Calibration Methods

SITRANS F 1010 equipment provides three ways to condition the calibration performance of its flowrate output: Intrinsic (factory set), Kc, and Calibration Tables 1 through 3. Access to these calibration options is found in the [Calibrate Flowrate] menu cell and the three [Calib. Table] menu cells of the [Span/Set/Cal] menu.

Intrinsic

When selected, the flowmeter uses no slope adjustment at all. Output data is still zeroed and corrected for Reynolds number, but no slope adjustment is imposed on the flow meter's flow register.

Some applications may require an output adjustment to match an official external reference. The [Calibrate Flowrate] menu allows you to select a calibration mode. The right-hand column shows the active calibration mode. You can select Intrinsic (factory) and Kc (Slope Correction) Calibration. Selecting either of the external calibration modes will not eliminate the Intrinsic (factory) calibration. You can use this menu cell to switch between Intrinsic and Kc at any time.

Kc Calibration

For most applications, the measured flow range produces a linear meter response. Therefore, the Kc (slope correction) calibration is the preferred method since it only requires a single correction factor for all the flow rates encountered.

Note

Changing the calibration can cause profound changes in flowmeter operating characteristics. Use only the most respected flow standard to obtain a correction factor. The percentage entered must provide an accurate and consistent shift across the entire flow range anticipated for the application.

Kc Factor

To obtain the Kc factor, compare flow total data taken simultaneously from the flowmeter and a reference meter whose accuracy meets the required standard. Allow both meters to accumulate flow total data long enough to average out any differences due to flow fluctuation between the two meter locations. Compare outputs of the two totalizers to determine percentage increase (+) or decrease (-) that is necessary to produce the best average correlation between the flowmeter and the reference standard.

Selecting the Kc Factor

When the [Kc] menu cell is selected, the flowmeter imposes this percentage slope adjustment of its rate output. Output data is zeroed and corrected for the Reynolds number (flow profile compensated), however, a percent change in the rate output is imposed based on the data entered in this cell. The number entered by the user is evaluated into a slope correction factor by dividing it by 100 and algebraically adding it to 1. The resulting factor is used as a multiplier on the rate register of the instrument. Thus an entry of -3% will multiply the rate register by 0.97, for example.

To calculate Kc:

$$Kc = \left[\frac{\text{Actual Rate}}{\text{Indicated Rate}} - 1 \right] \times 100$$

To enter the Kc Factor

1. To enable numeric entry press <Right>.
2. Use the numeric keys to type the required Kc (as calculated above). Note that the Kc value can be negative or positive. Enter the - or + sign first, then type in the calibrated value.
3. To store the data press <ENT>. Note that Kc now appears in the right-hand column of the [Calibrate Flow Rate] menu cell with its new value. Also note that this Kc value can be viewed on the site printout.

Calibration Tables 1 through 3

SITRANS F 1010 instruments offer a unique methodology by which a particular flow response of an instrument may be linearized or optimized by tabulating the results of a series of calibration exercises or collected batch data points. Basically, the flowmeter allows the user to select any of a wide variety of system variables (flowrate, pressure, viscosity, etc.) as a pointer into a table of calibration factors (up to 32). As the system variable is updated, the value of the table's output factors (or positive and negative flow) is re-evaluated and used as a modifier for the current rate register. Note that the flow register is still zeroed and Reynolds number compensated normally and these slope corrections are in addition to these fundamentals.

Note

Kc is still active when this method is being used.

To install a Calibration table:

1. The user selects a system variable that appears to correlate strongly with calibration shifts observed.
2. A table of values is formed comprised of the values that this index could assume over the range of system operation. Remember, the tables created do not extrapolate beyond their end points, they "clip."
3. A calibration factor, a number usually close to 1.00, is entered as a positive and a negative flowrate correction factor (termed PosFlow Corr and NegFlow Corr) for each of the desired index points.

The table may contain up to 32 pairs of these slope correction factors. Note that the Kc factor, unlike these slope correction factors, is entered as a signed percent change in rate, while these factors are simply rate multipliers. As points are entered, the point editor will provide list access to the already entered points plus access to the [New Point] menu cell, used to add a new point. The table may be created in its entirety and then activated by selecting [Yes] in the [Table Active] menu cell. The entire table may be cleared by selecting [Yes] in the [Clear Table] menu cell.

Note

Careless use of the calibration tables can have a detrimental impact on the measurement performance of the flowmeter.

Note

Take precautions before enabling these calibration tables. Although it is unlikely that all three tables would ever be employed in a real installation, three tables are offered for maximum user flexibility. Since the tables can be disabled without being destroyed, 2 or 3 optimization strategies may be tested by this means in order to determine which approach is most effective.

A.5 Setting Thermal Coefficient and Modulus of Elasticity

Introduction

This operating system includes routines that will compensate the measured raw flow rate for dynamic changes in the pipe dimensions, caused by variations in line temperature and pressure supplied to the flowmeter. To account for variations in pipe material, two data entry items (Thermal Expansion Coefficient and Modulus of Elasticity) are provided in the Pipe Data menu screen (see sample menu screen below).

The equation used to automatically compute the change in pipe inside diameter is:

$$d_1 = d_0(1 + \alpha(T_1 - T_0)) * \left(1 + d_0 \frac{(P_1 - P_0)}{E_w}\right)$$

Where:

- d_0 = inside diameter of pipe at STP
- d_1 = inside diameter of pipe after temperature and pressure change
- w = pipe wall thickness
- T_0 and P_0 = Standard temperature and pressure
- T_1 and P_1 = Operating temperature and pressure
- α = Coefficient of Thermal Expansion of Pipe material
- E = Modulus of Elasticity of pipe material

Siemens Dual Path [1] ABC	
Pipe Thermal Expansion Factor (1.0e-6)	
Pick Pipe Class	ASA Carb. Steel
Select Pipe Size	8CS40
Pipe OD <in>	8.625
Pipe Material	Steel
Wall Thickness	0.322
Liner Material	None
Linear Thickness	0.000
ThermExp Coef 1/F	0.00
Mod of Elast PSI	0.00
Pipe Data	

- ① Use this menu cell to change the Modulus Of Elasticity of the pipe wall.
- ② Use this menu cell to edit the Thermal Expansion Coefficient of the pipe wall.

The default value for each of these new parameters is 0.0. A value of zero effectively disables the pressure and temperature pipe volume compensation routine. When entering a value for the thermal expansion coefficient and modulus of elasticity, keep in mind that the numeric entry already includes an exponent multiplier. For the Thermal Expansion Coefficient the multiplier is 10^{-6} and for the Modulus of Elasticity the multiplier is 10^6 .

Typical values for each parameter are shown below:

Pipe Material	Thermal Expansion	Modulus of Elasticity
Mild Carbon Steel	$6.20 \times 10^{-6} \text{ F}^{-1}$ ($11.16 \times 10^{-6} \text{ C}^{-1}$)	$30 \times 10^6 \text{ psi}$ $2.07 \times 10^6 \text{ bar}$
304 Stainless	$9.60 \times 10^{-6} \text{ F}^{-1}$ ($17.28 \times 10^{-6} \text{ C}^{-1}$)	$28 \times 10^6 \text{ psi}$ $1.93 \times 10^6 \text{ bar}$
316 Stainless	$8.83 \times 10^{-6} \text{ F}^{-1}$ ($15.89 \times 10^{-6} \text{ C}^{-1}$)	$28 \times 10^6 \text{ psi}$ $1.93 \times 10^6 \text{ bar}$

Note

Do not enter exponents of above values.

[ThermExp Coef 1/F]

Use this menu cell to set the Thermal Expansion Coefficient.

Entering the Thermal Expansion Coefficient value:

1. In the [Pipe Data] menu, scroll down to highlight [ThermExp Coef 1/F].
2. To enable numeric entry press <Right Arrow>.
3. Use the number keys to type the Thermal Coefficient value.
4. To register the data press <ENT>.

Mod of Elast PSI

Use this menu cell to set the Modular Elasticity in PSI.

Entering the Modulus of Elasticity value:

1. In the [Pipe Data] menu, scroll down to highlight [Mod of Elast PSI].
2. To enable numeric entry press <Right Arrow>.
3. Use the number keys to type the Modular Elasticity PSI value.
4. To register the data press <ENT>.

Appendix

B.1 Installation/Outline Drawings

Installation/Outline Drawings

The following are the installation and outline drawings for the SITRANS FUT1010 flowmeter.

1010DN-7 - Installation Drawing, 1010 Series Dual Channel Flowmeter

1010DN-8 - Outline Dimensions, 1010 Series Dual Channel Flowmeter

1010NS2-7 - Installation Drawing, 1010 Series Flowmeter, Agency Approved

1010NS2-8 - Outline Dimensions, 1010 Series Flowmeter, Agency Approved

1010MWX-7 - Installation Drawing, 1010 Series Multi-Channel Flowmeter

1010MN-7 - Installation Drawing, 1010 Series Multi-Channel Flowmeter

1010MN-8 - Outline Dimensions, 1010 Series Multi-Channel Flowmeter

1010N-7-7 - Installation Wiring, Expanded I/O Module

A5E02716838A - Installation, FUT Sensor, Hazardous Locations

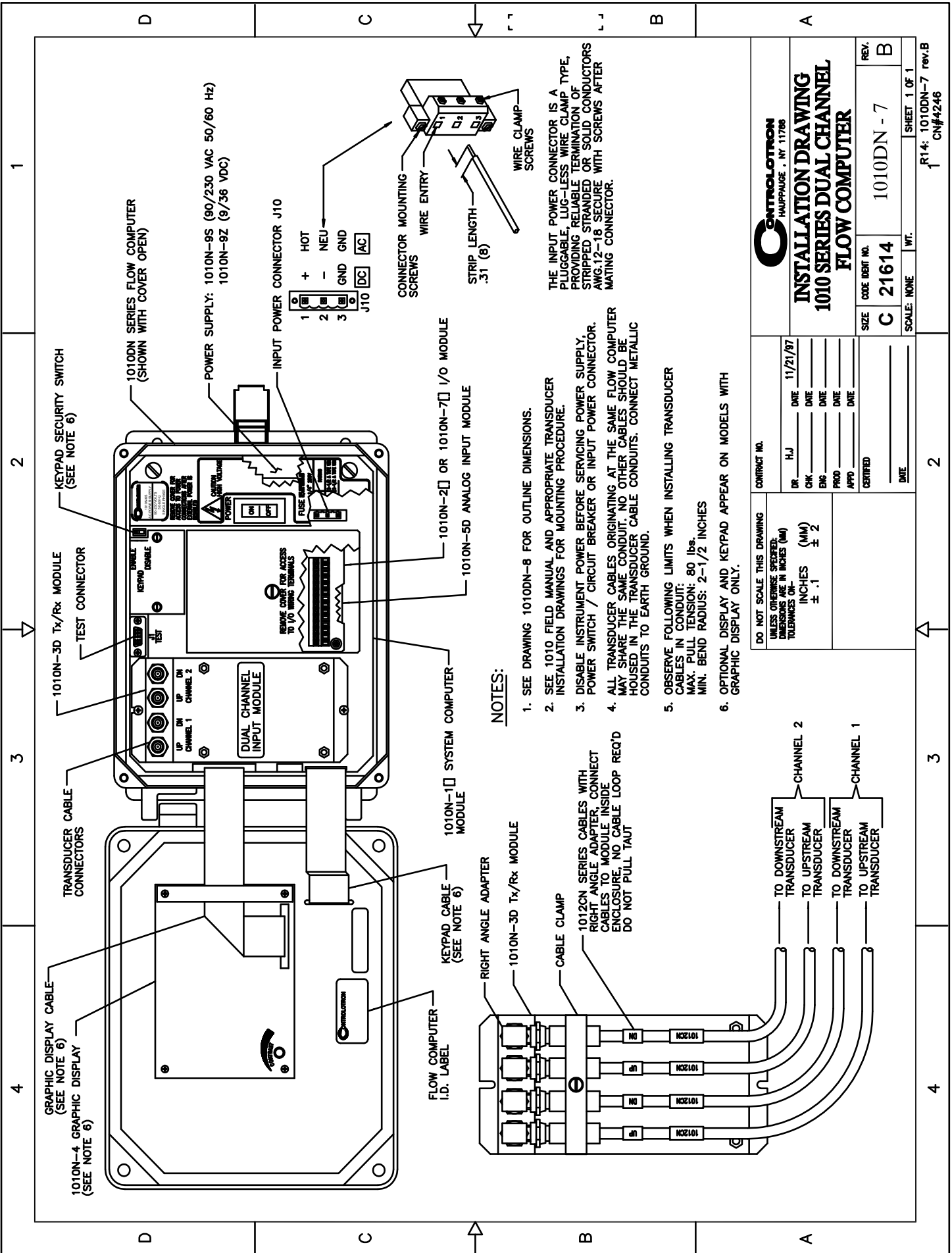

NOTES:

1. SEE DRAWING 1010DN-8 FOR OUTLINE DIMENSIONS.
2. SEE 1010 FIELD MANUAL AND APPROPRIATE TRANSDUCER INSTALLATION DRAWINGS FOR MOUNTING PROCEDURE.
3. DISABLE INSTRUMENT POWER BEFORE SERVICING POWER SUPPLY, POWER SWITCH / CIRCUIT BREAKER OR INPUT POWER CONNECTOR.
4. ALL TRANSDUCER CABLES ORIGINATING AT THE SAME FLOW COMPUTER MAY SHARE THE SAME CONDUIT. NO OTHER CABLES SHOULD BE HOUSED IN THE TRANSDUCER CABLE CONDUITS. CONNECT METALLIC CONDUITS TO EARTH GROUND.
5. OBSERVE FOLLOWING LIMITS WHEN INSTALLING TRANSDUCER CABLES IN CONDUIT:
 MAX. PULL TENSION: 80 lbs.
 MIN. BEND RADIUS: 2-1/2 INCHES
6. OPTIONAL DISPLAY AND KEYPAD APPEAR ON MODELS WITH GRAPHIC DISPLAY ONLY.

THE INPUT POWER CONNECTOR IS A PLUGGABLE, LUG-LESS WIRE CLAMP TYPE, PROVIDING RELIABLE TERMINATION OF STRIPPED STRANDED OR SOLID CONDUCTORS AWG.12-18 SECURE WITH SCREWS AFTER MATING CONNECTOR.

CONTROLTRON HAUPPAUGE, NY 11788	
INSTALLATION DRAWING 1010 SERIES DUAL CHANNEL FLOW COMPUTER	
CONTRACT NO. HJ DATE 11/21/87	REV. B
DR CHK ENG PRD APPD CERTIFIED DATE	SIZE C
CODE IDENT NO. 21614	MODEL NO. 1010DN - 7
SCALE: NONE	WT.
SHEET 1 OF 1	R14: 1010DN-7 rev.B CN#4246

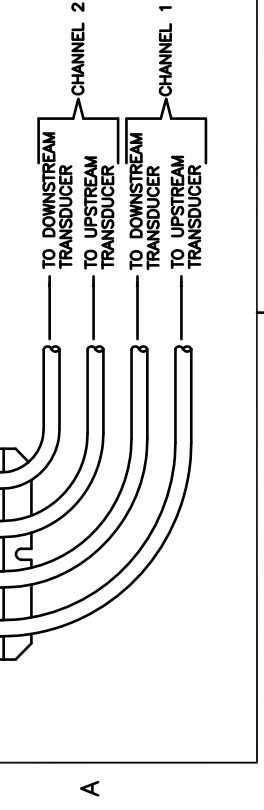

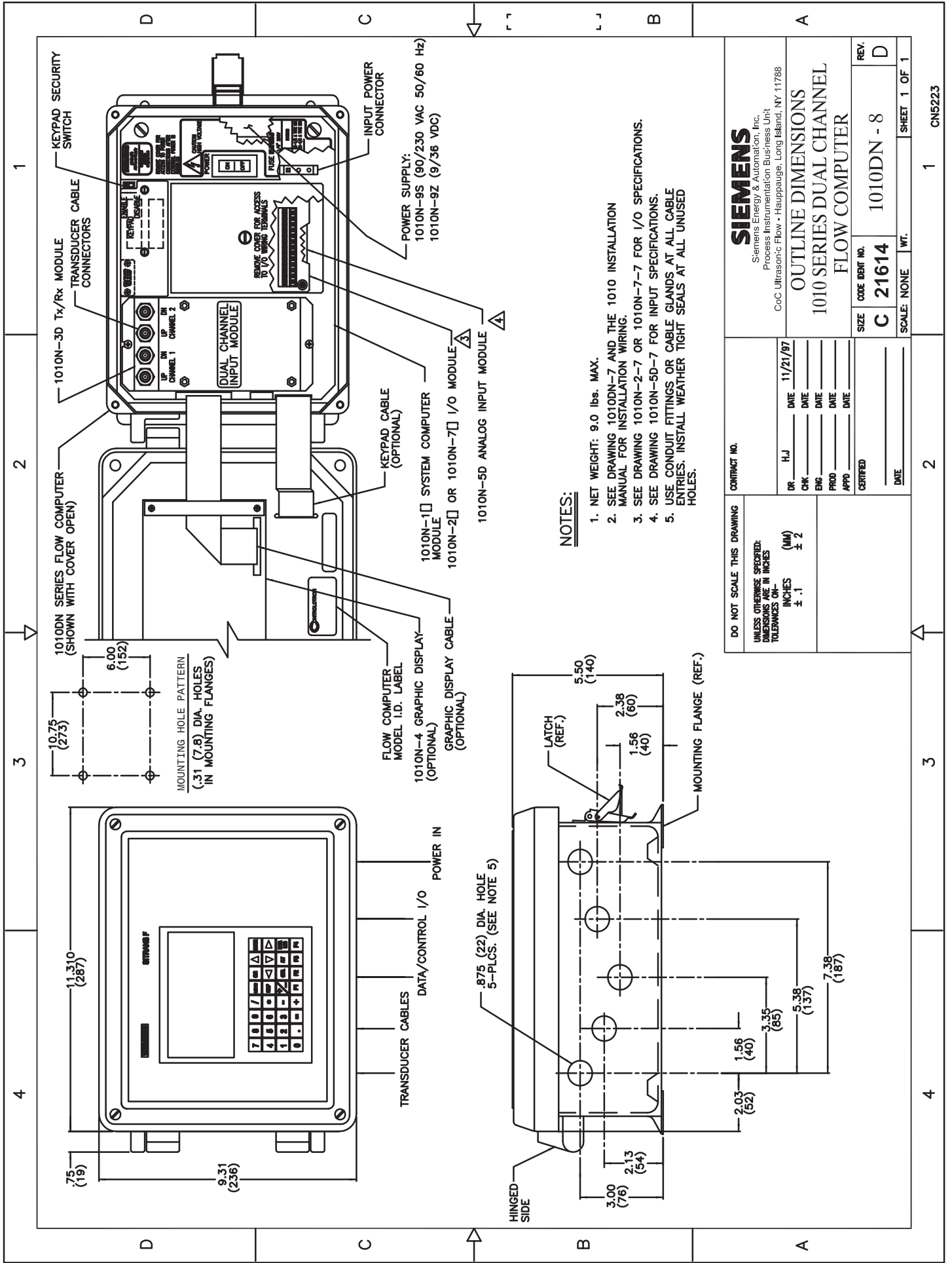

<p>SIEMENS Siemens Energy & Automation Inc. Process Instrumentation Business Unit CoC Ultrasonic Flow - Hauppauge, Long Island, NY 11788</p>		<p>OUTLINE DIMENSIONS 1010 SERIES DUAL CHANNEL FLOW COMPUTER</p>		<p>SIZE C CODE IDENT NO. 21614 1010DN - 8 REV. D</p>
<p>DO NOT SCALE THIS DRAWING UNLESS OTHERWISE SPECIFIED: DIMENSIONS ARE IN INCHES TOLERANCES ON— INCHES ± .1 (MM) ± .2</p>		<p>CONTRACT NO. _____ DATE _____ H/J _____ DR _____ CHK _____ ENG _____ PROJ _____ APPO _____ CERTIFIED _____</p>		<p>SCALE: NONE WT. _____ SHEET 1 OF 1</p>

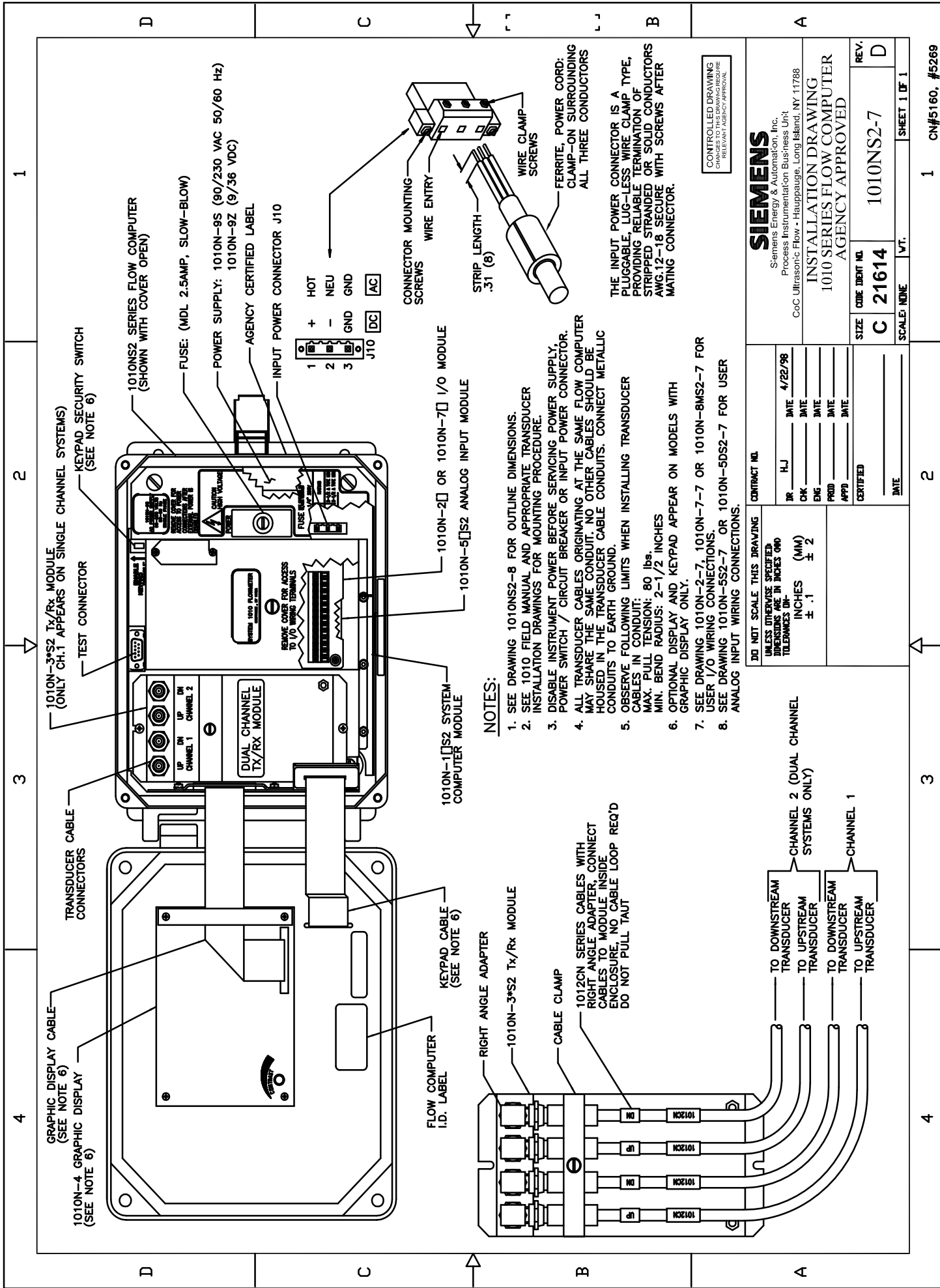

NOTES:

- SEE DRAWING 1010NS2-8 FOR OUTLINE DIMENSIONS.
- SEE 1010 FIELD MANUAL AND APPROPRIATE TRANSDUCER INSTALLATION DRAWINGS FOR MOUNTING PROCEDURE.
- DISABLE INSTRUMENT POWER BEFORE SERVICING POWER SUPPLY, POWER SWITCH / CIRCUIT BREAKER OR INPUT POWER CONNECTOR.
- ALL TRANSDUCER CABLES ORIGINATING AT THE SAME FLOW COMPUTER MAY SHARE THE SAME CONDUIT; NO OTHER CABLES SHOULD BE HOUSED IN THE TRANSDUCER CABLE CONDUITS. CONNECT METALLIC CONDUITS TO EARTH GROUND.
- OBSERVE FOLLOWING LIMITS WHEN INSTALLING TRANSDUCER CABLES IN CONDUIT:
MAX. PULL TENSION: 80 lbs.
MIN. BEND RADIUS: 2-1/2 INCHES
GRAPHIC DISPLAY ONLY.
- OPTIONAL DISPLAY AND KEYPAD APPEAR ON MODELS WITH GRAPHIC DISPLAY ONLY.
- SEE DRAWING 1010N-2-7, 1010N-7-7 OR 1010N-8MS2-7 FOR USER I/O WIRING CONNECTIONS.
- SEE DRAWING 1010N-5S2-7 OR 1010N-5DS2-7 FOR USER ANALOG INPUT WIRING CONNECTIONS.

THE INPUT POWER CONNECTOR IS A PLUGGABLE, LUG-LESS WIRE CLAMP TYPE, PROVIDING RELIABLE TERMINATION OF STRIPPED STRANDED OR SOLID CONDUCTORS AWG 12-18 SECURE WITH SCREWS AFTER MATING CONNECTOR.

CONTROLLED DRAWING
CHANGES TO THIS DRAWING REQUIRE
RELEVANT AGENCY APPROVAL

SIEMENS
Siemens Energy & Automation, Inc.
Process Instrumentation Business Unit
Co.C. Ultrasonic Flow - Hauppauge, Long Island, NY 11788

INSTALLATION DRAWING
1010 SERIES FLOW COMPUTER
AGENCY APPROVED

SIZE	CODE IDENT NO.	REV.
C	21614	1010NS2-7
SCALE: NONE	VT.	SHEET 1 OF 1

DO NOT SCALE THIS DRAWING
UNLESS OTHERWISE SPECIFIED
DIMENSIONS ARE IN INCHES AND
TOLERANCES ARE:
INCHES ± .1
(MM) ± .2

CONTRACT NO.	HJ	DATE	4/22/98
DR	CK	DATE	
ENG	DATE	DATE	
PROD	DATE	DATE	
APPD	DATE	DATE	
CERTIFIED			
DATE			

TO DOWNSTREAM TRANSDUCER (CHANNEL 2 DUAL CHANNEL SYSTEMS ONLY)
TO UPSTREAM TRANSDUCER
TO DOWNSTREAM TRANSDUCER
TO UPSTREAM TRANSDUCER (CHANNEL 1)

1012CN SERIES CABLES WITH RIGHT ANGLE ADAPTER, CONNECT CABLES TO MODULE INSIDE ENCLOSURE. NO CABLE LOOP REQ'D DO NOT PULL TAUT

FLOW COMPUTER I.D. LABEL
KEYPAD CABLE (SEE NOTE 6)
RIGHT ANGLE ADAPTER
1010N-3*S2 Tx/Rx MODULE
CABLE CLAMP

1010N-1[S2] SYSTEM COMPUTER MODULE
1010N-2[] OR 1010N-7[] I/O MODULE
1010N-5[S2] ANALOG INPUT MODULE

1010N-3*S2 Tx/Rx MODULE (ONLY CH.1 APPEARS ON SINGLE CHANNEL SYSTEMS)
KEYPAD SECURITY SWITCH (SEE NOTE 6)
TEST CONNECTOR
1010NS2 SERIES FLOW COMPUTER (SHOWN WITH COVER OPEN)
FUSE: (MDL 2.5AMP, SLOW-BLOW)
POWER SUPPLY: 1010N-9S (90/230 VAC 50/60 Hz) 1010N-9Z (9/36 VDC)
AGENCY CERTIFIED LABEL
INPUT POWER CONNECTOR J10

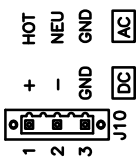

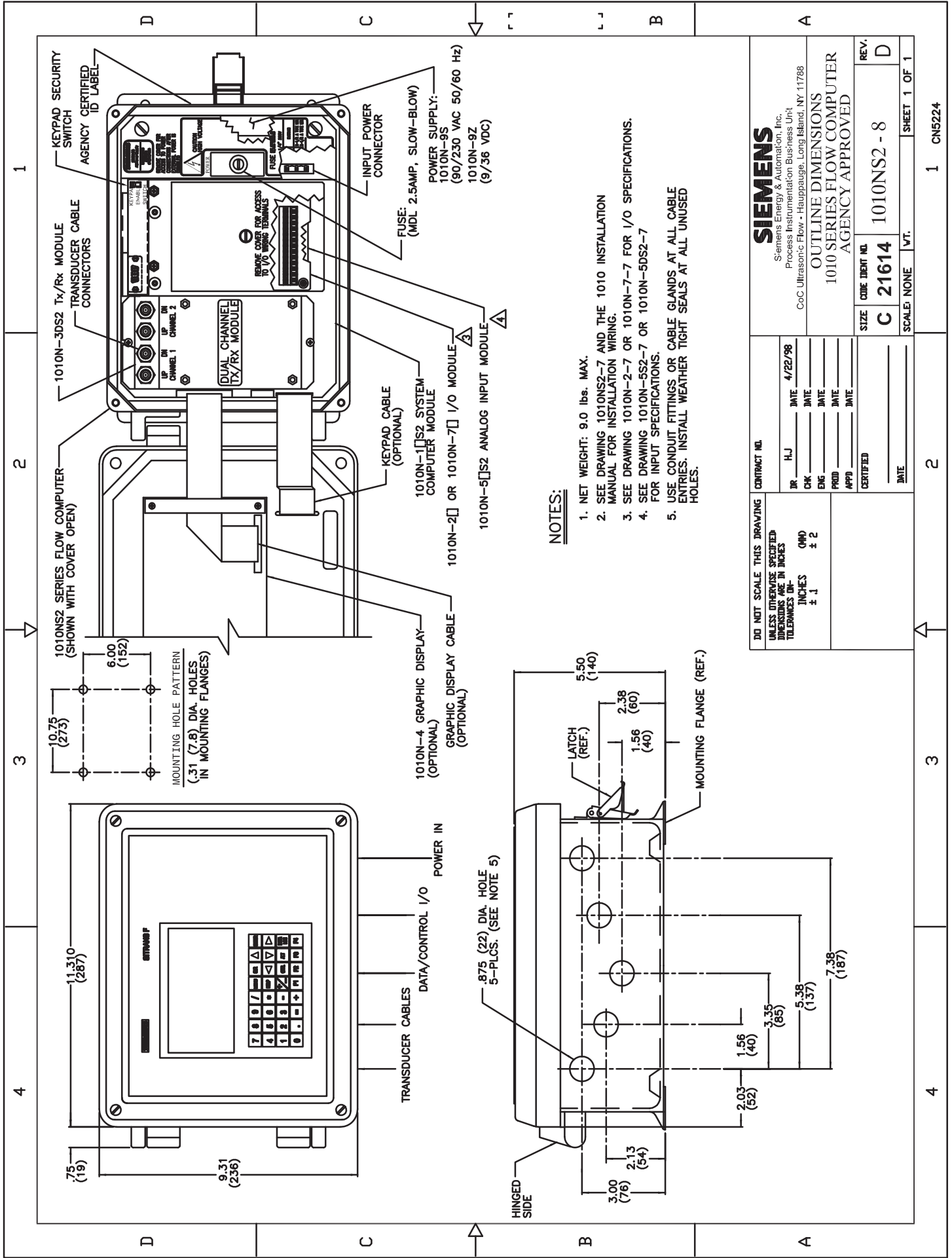

NOTES:

1. NET WEIGHT: 9.0 lbs. MAX.
2. SEE DRAWING 1010NS2-7 AND THE 1010 INSTALLATION MANUAL FOR INSTALLATION WIRING.
3. SEE DRAWING 1010N-2-7 OR 1010N-7-7 FOR I/O SPECIFICATIONS.
4. SEE DRAWING 1010N-5S2-7 OR 1010N-5DS2-7 FOR INPUT SPECIFICATIONS.
5. USE CONDUIT FITTINGS OR CABLE GLANDS AT ALL CABLE ENTRIES. INSTALL WEATHER TIGHT SEALS AT ALL UNUSED HOLES.

SIEMENS Siemens Energy & Automation, Inc. Process Instrumentation Business Unit CoC Ultrasonic Flow - Hauppauge, Long Island, NY 11788		CONTRACT NO. _____	
OUTLINE DIMENSIONS 1010 SERIES FLOW COMPUTER AGENCY APPROVED		DATE 4/22/98	
SIZE CODE IDENT NO.		DATE _____	
C 21614 1010NS2 - 8		DATE _____	
SCALE: NONE		DATE _____	
REV. D		DATE _____	
SHEET 1 OF 1		DATE _____	

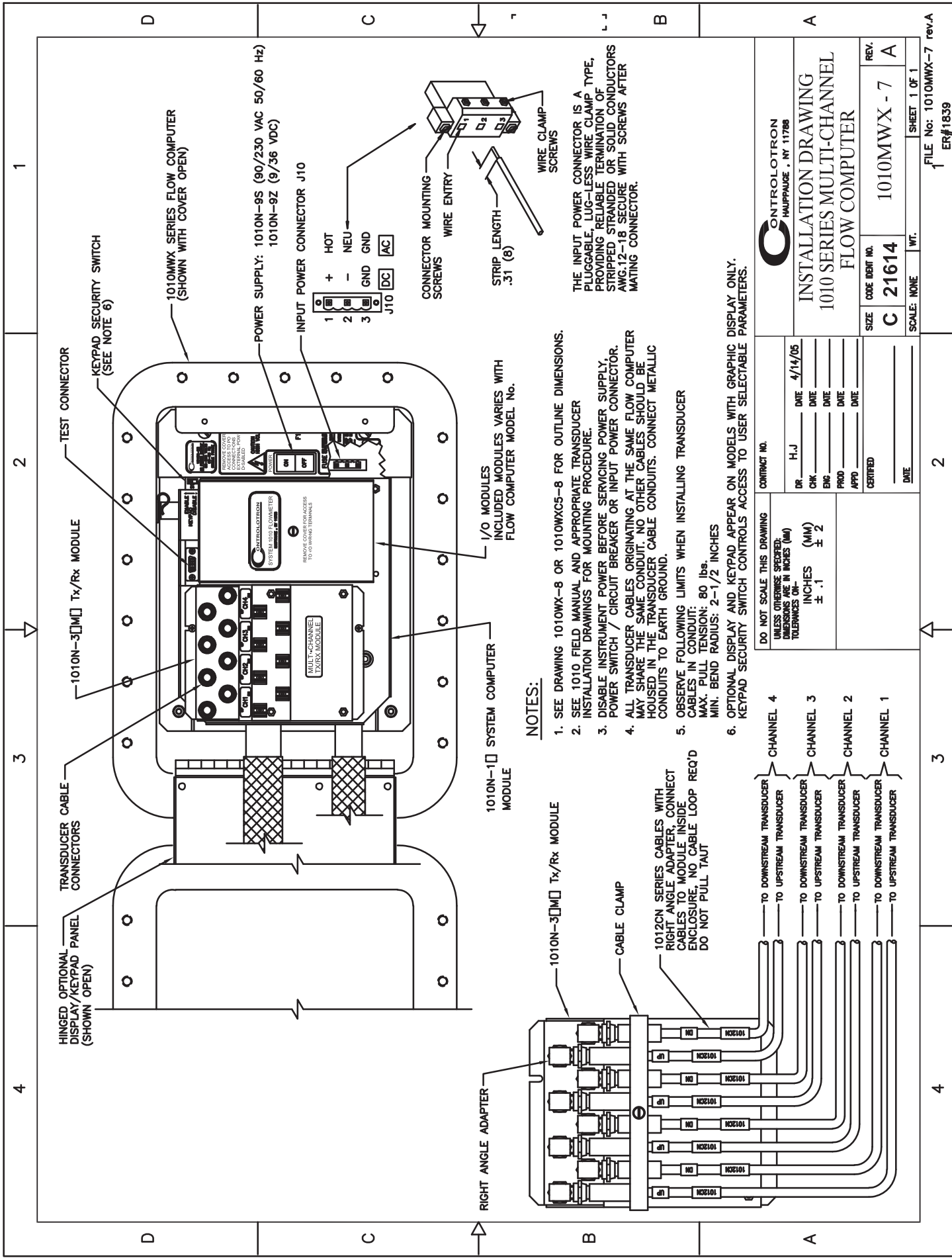

NOTES:

1. SEE DRAWING 1010WX-8 OR 1010WXS-8 FOR OUTLINE DIMENSIONS.
2. SEE 1010 FIELD MANUAL AND APPROPRIATE TRANSDUCER INSTALLATION DRAWINGS FOR MOUNTING PROCEDURE.
3. DISABLE INSTRUMENT POWER BEFORE SERVICING POWER SUPPLY, POWER SWITCH / CIRCUIT BREAKER OR INPUT POWER CONNECTOR.
4. ALL TRANSDUCER CABLES ORIGINATING AT THE SAME FLOW COMPUTER MAY SHARE THE SAME CONDUIT. NO OTHER CABLES SHOULD BE HOUSED IN THE TRANSDUCER CABLE CONDUITS. CONNECT METALLIC CONDUITS TO EARTH GROUND.
5. OBSERVE FOLLOWING LIMITS WHEN INSTALLING TRANSDUCER CABLES IN CONDUIT:
 MAX. PULL TENSION: 80 lbs.
 MIN. BEND RADIUS: 2-1/2 INCHES
6. OPTIONAL DISPLAY AND KEYPAD APPEAR ON MODELS WITH GRAPHIC DISPLAY ONLY. KEYPAD SECURITY SWITCH CONTROLS ACCESS TO USER SELECTABLE PARAMETERS.

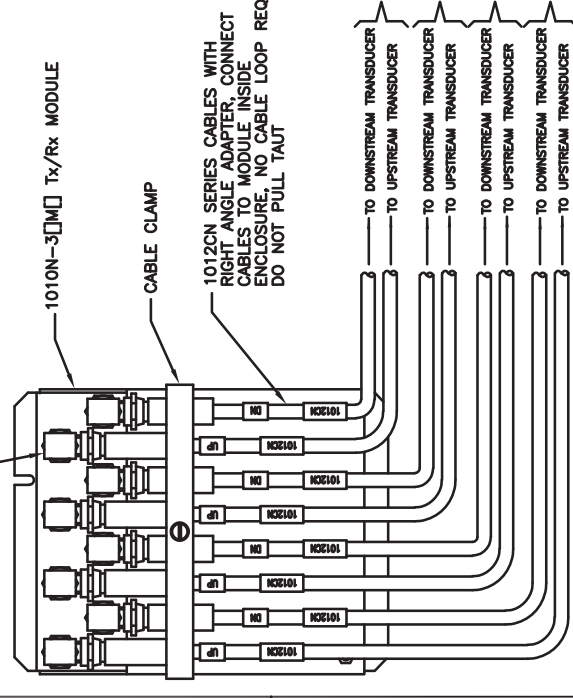

 CONTROLOTRON HAUPPAUGE, NY 11788	
INSTALLATION DRAWING 1010 SERIES MULTI-CHANNEL FLOW COMPUTER	
CONTRACT NO. DR H-J CHK ENG PRD APPD CERTIFIED DATE	DATE 4/14/05 DATE DATE DATE DATE
DO NOT SCALE THIS DRAWING UNLESS OTHERWISE SPECIFIED: DIMENSIONS ARE IN INCHES (IN) TOLERANCES ARE: INCHES $\pm .1$ (MM) ± 2	SIZE CODE DEBIT NO. REV. C 21614 1010MWX-7 A
SCALE: NONE	WT.
SHEET 1 OF 1	

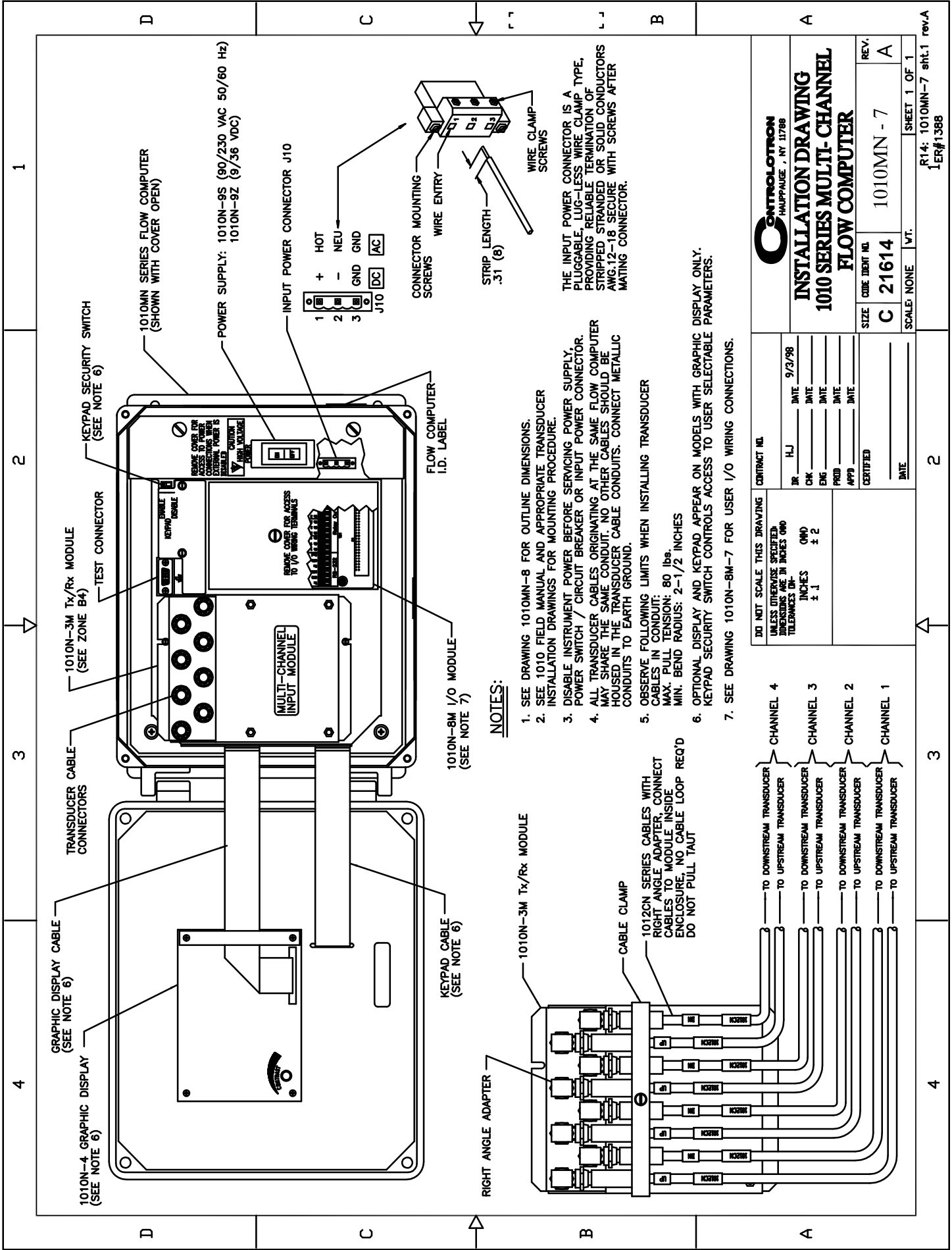

NOTES:

- SEE DRAWING 1010MN-8 FOR OUTLINE DIMENSIONS.
- SEE 1010 FIELD MANUAL AND APPROPRIATE TRANSDUCER INSTALLATION DRAWINGS FOR MOUNTING PROCEDURE.
- DISABLE INSTRUMENT POWER BEFORE SERVICING POWER SUPPLY, POWER SWITCH / CIRCUIT BREAKER OR INPUT POWER CONNECTOR.
- ALL TRANSDUCER CABLES ORIGINATING AT THE SAME FLOW COMPUTER MAY SHARE THE SAME CONDUIT. NO OTHER CABLES SHOULD BE HOUSED IN THE TRANSDUCER CABLE CONDUITS. CONNECT METALLIC CONDUITS TO EARTH GROUND.
- OBSERVE FOLLOWING LIMITS WHEN INSTALLING TRANSDUCER CABLES IN CONDUIT:
 MAX. PULL TENSION: 80 lbs.
 MIN. BEND RADIUS: 2-1/2 INCHES
- OPTIONAL DISPLAY AND KEYPAD APPEAR ON MODELS WITH GRAPHIC DISPLAY ONLY. KEYPAD SECURITY SWITCH CONTROLS ACCESS TO USER SELECTABLE PARAMETERS.
- SEE DRAWING 1010N-8M-7 FOR USER I/O WIRING CONNECTIONS.

THE INPUT POWER CONNECTOR IS A PLUGGABLE, LUG-LESS WIRE CLAMP TYPE, PROVIDING RELIABLE TERMINATION OF STRIPPED STRANDED OR SOLID CONDUCTORS AWG 12-18. SECURE WITH SCREWS AFTER MATING CONNECTOR.

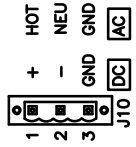

HAUPPAUGE, NY 11788	
INSTALLATION DRAWING 1010 SERIES MULTI-CHANNEL FLOW COMPUTER	
SIZE C 21614	CODE IDENT NO. 1010MN - 7
SCALE: NONE	REV. A
VT.	SHEET 1 OF 1

DO NOT SCALE THIS DRAWING UNLESS OTHERWISE SPECIFIED, DIMENSIONS ARE IN INCHES AND TOLERANCES UNLESS OTHERWISE SPECIFIED	CONTRACT NO. IR H.J. DATE 9/3/98 CHK DATE ENG DATE PRD DATE APP DATE CERTIFIED DATE
---	---

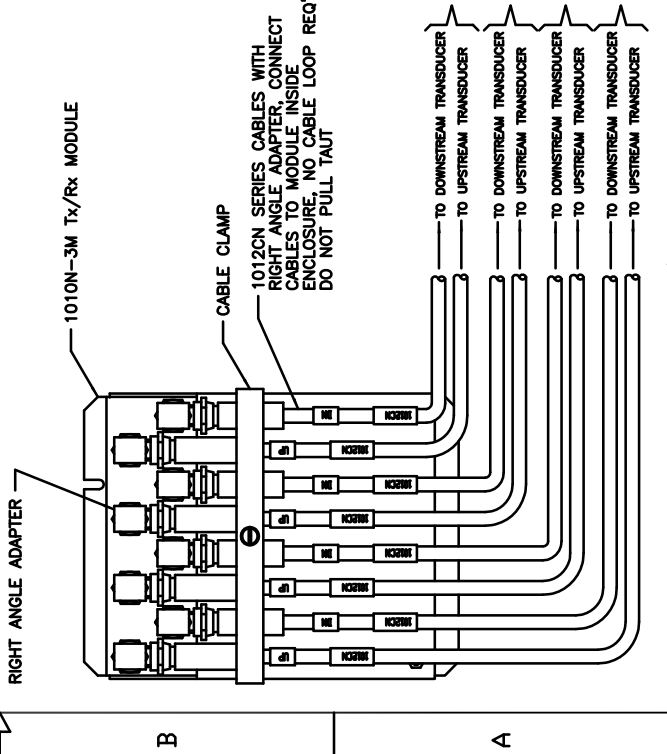

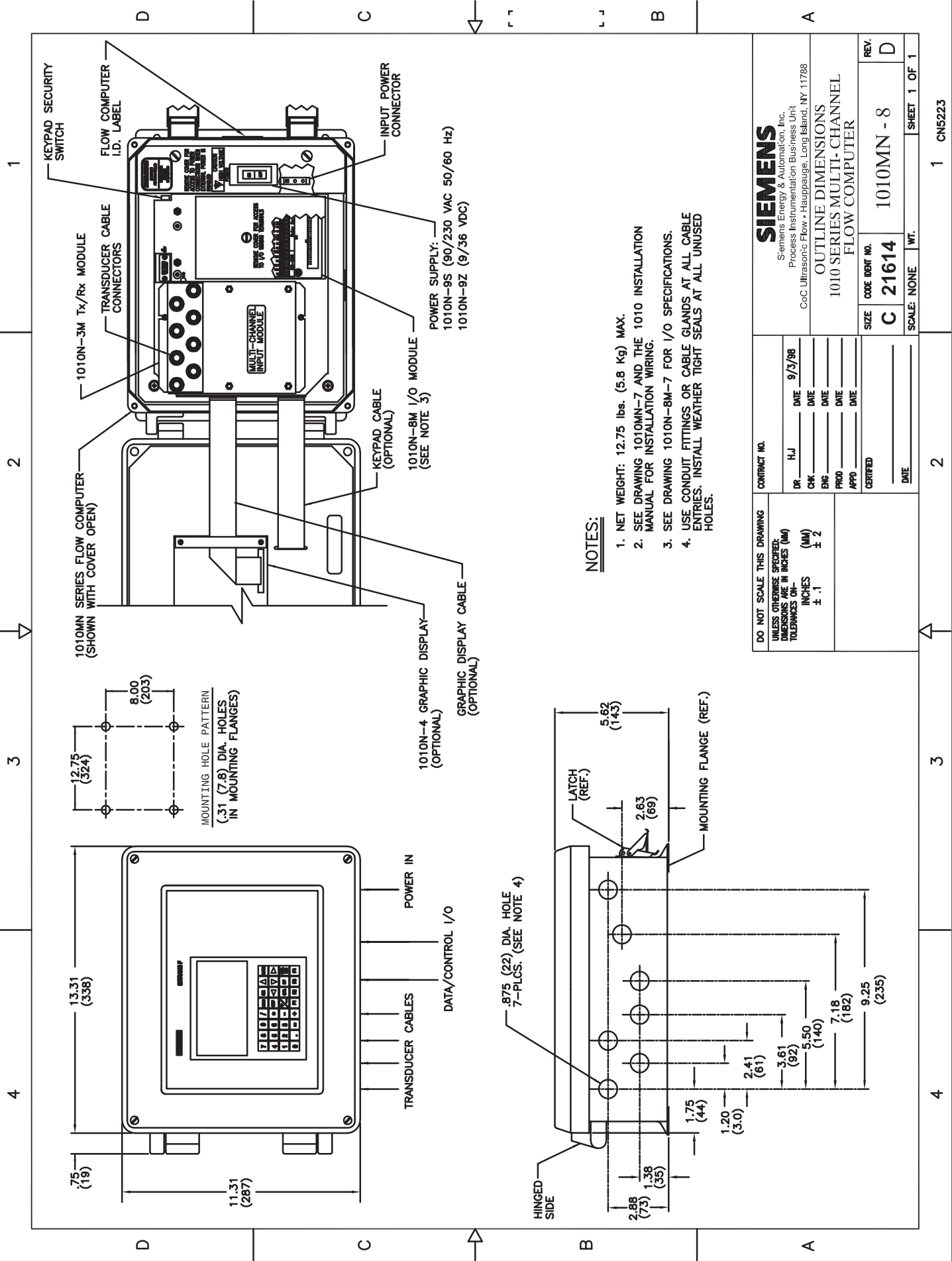

NOTES:

1. NET WEIGHT: 12.75 lbs. (5.8 Kg) MAX.
2. SEE DRAWING 1010MN-7 AND THE 1010 INSTALLATION MANUAL FOR INSTALLATION WIRING.
3. SEE DRAWING 1010N-8M-7 FOR I/O SPECIFICATIONS.
4. USE CONDUIT FITTINGS OR CABLE GLANDS AT ALL CABLE ENTRIES. INSTALL WEATHER TIGHT SEALS AT ALL UNUSED HOLES.

SIEMENS Siemens Energy & Automation, Inc. Process Instrumentation Business Unit CoC Ultrasonic Flow - Heppauge, Long Island, NY 11788		OUTLINE DIMENSIONS 1010 SERIES MULTI-CHANNEL FLOW COMPUTER	SIZE C 21614	CODE IDENT NO. 1010MN - 8	REV. D
DO NOT SCALE THIS DRAWING UNLESS OTHERWISE SPECIFIED: DIMENSIONS ARE IN INCHES (MM) TOLERANCES ON- INCHES ± .1 (MM) ± .2		CONTRACT NO. HLJ DATE 9/3/98 CHK DATE ENG DATE PRD DATE APPD DATE CERTIFIED DATE	SCALE: NONE WT. SHEET 1 OF 1		

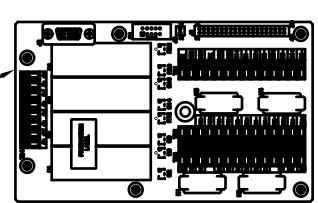
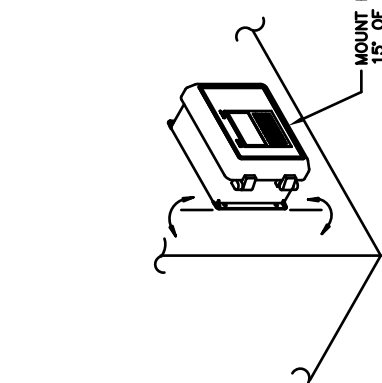
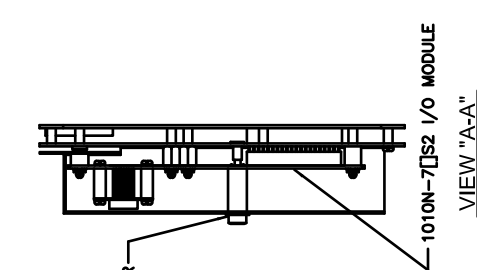
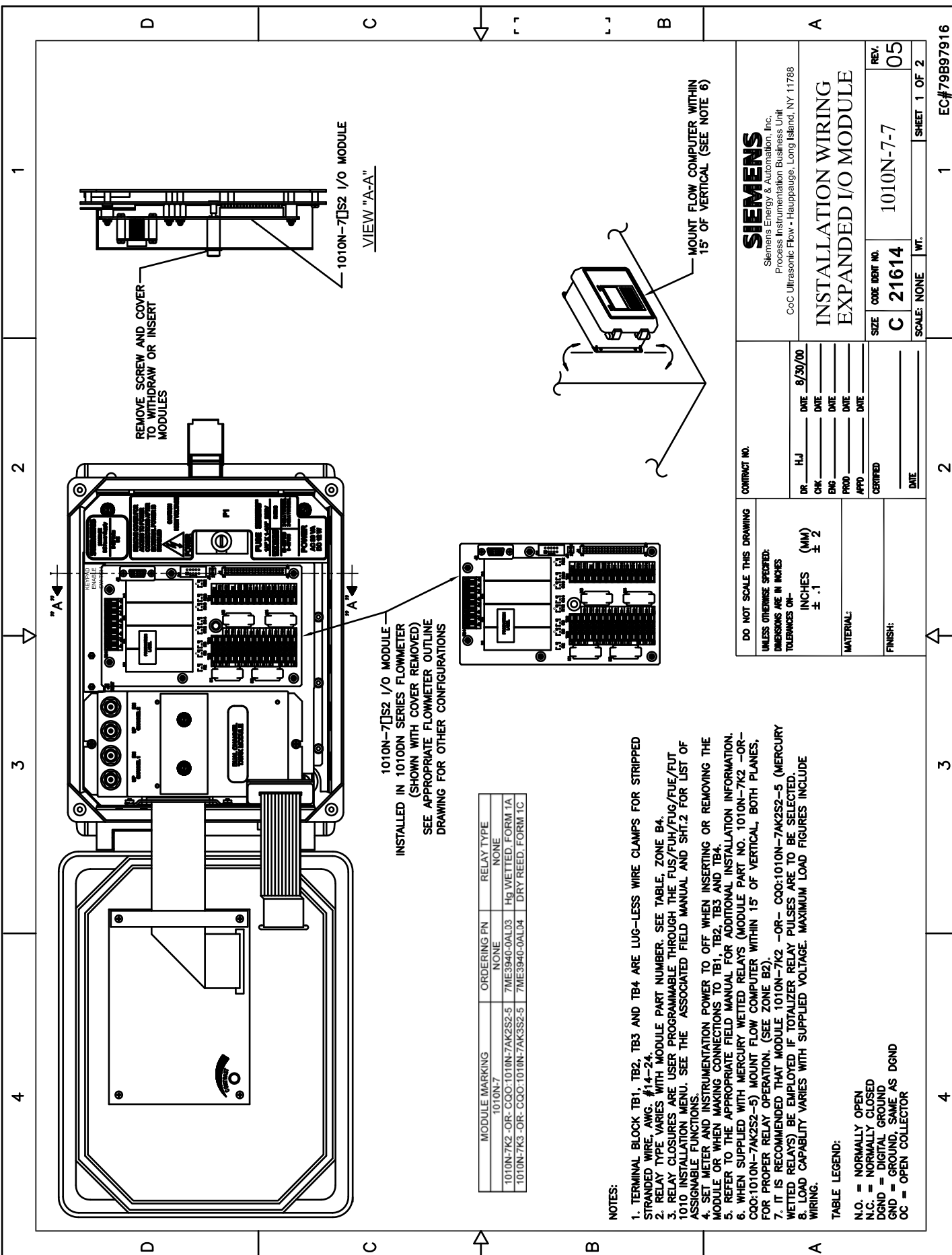

1010N-7[S2] I/O MODULE
 INSTALLED IN 1010DN SERIES FLOWMETER
 (SHOWN WITH COVER REMOVED)
 SEE APPROPRIATE FLOWMETER OUTLINE
 DRAWING FOR OTHER CONFIGURATIONS

MODULE MARKING	ORDERING PN	RELAY TYPE
1010N-7	NONE	NONE
1010N-7K2 -OR- C00:1010N-7AK2S2-5	7ME3940-0AL03	Hg WETTED, FORM 1A
1010N-7K3 -OR- C00:1010N-7AK3S2-5	7ME3940-0AL04	DRY REED, FORM 1C

- NOTES:
1. TERMINAL BLOCK TB1, TB2, TB3 AND TB4 ARE LUG-LESS WIRE CLAMPS FOR STRIPPED STRANDED WIRE, AWG. #14-24.
 2. RELAY TYPE VARIES WITH MODULE PART NUMBER. SEE TABLE, ZONE B4.
 3. RELAY CLOSURES ARE USER PROGRAMMABLE THROUGH THE FUS/FUH/FLUG/FUE/FLUT 1010 INSTALLATION MENU. SEE THE ASSOCIATED FIELD MANUAL AND SHT.2 FOR LIST OF ASSIGNABLE FUNCTIONS.
 4. SET METER AND INSTRUMENTATION POWER TO OFF WHEN INSERTING OR REMOVING THE MODULE OR WHEN MAKING CONNECTIONS TO TB1, TB2, TB3 AND TB4.
 5. REFER TO THE APPROPRIATE FIELD MANUAL FOR ADDITIONAL INSTALLATION INFORMATION.
 6. WHEN SUPPLIED WITH MERCURY WETTED RELAYS (MODULE PART NO. 1010N-7K2 -OR- C00:1010N-7AK2S2-5) MOUNT FLOW COMPUTER WITHIN 15° OF VERTICAL, BOTH PLANES, FOR PROPER RELAY OPERATION. (SEE ZONE B2).
 7. IT IS RECOMMENDED THAT MODULE 1010N-7K2 -OR- C00:1010N-7AK2S2-5 (MERCURY WETTED RELAYS) BE EMPLOYED IF TOTALIZER RELAY PULSES ARE TO BE SELECTED.
 8. LOAD CAPABILITY VARIES WITH SUPPLIED VOLTAGE. MAXIMUM LOAD FIGURES INCLUDE WIRING.

TABLE LEGEND:

N.O. = NORMALLY OPEN
 N.C. = NORMALLY CLOSED
 DGND = DIGITAL GROUND
 GND = GROUND, SAME AS DGND
 OC = OPEN COLLECTOR

SIEMENS
 Siemens Energy & Automation, Inc.
 Process Instrumentation Business Unit
 CoC Ultrasonic Flow - Hauppauge, Long Island, NY 11788

**INSTALLATION WIRING
 EXPANDED I/O MODULE**

CONTRACT NO. _____
 DR. HJ _____ DATE 8/30/00
 CHK. _____ DATE _____
 ENG. _____ DATE _____
 PRD. _____ DATE _____
 APP. _____ DATE _____
 CERTIFIED _____
 DATE _____

DO NOT SCALE THIS DRAWING
 UNLESS OTHERWISE SPECIFIED:
 DIMENSIONS ARE IN INCHES
 TOLERANCES ON:
 INCHES (MM)
 $\pm .1$ (± 2)

MATERIAL: _____
 FINISH: _____

SIZE CODE BENT NO. C 21614
 1010N-7-7
 SCALE: NONE WT. _____ SHEET 1 OF 2

REV. 05

TERMINAL BLOCK WIRING CONNECTIONS

METER PN'S AND OPERATING SYSTEMS		"7ME350" SITRANS FUE1010 OP SYSTEMS: 5BN01-->5BN04		"7ME360" SITRANS FUS1010 OP SYSTEMS: 5BN01-->5BN02		"7ME360" SITRANS FUE1010 OP SYSTEMS: 5BN01-->5BN04		"7ME361" SITRANS FUS1010 OP SYSTEMS: 5BN01-->5BN02	
METER PN'S AND OPERATING SYSTEMS		"7ME350" SITRANS FUE1010 OP SYSTEMS: 5BN01-->5BN04		"7ME360" SITRANS FUS1010 OP SYSTEMS: 5BN01-->5BN02		"7ME360" SITRANS FUE1010 OP SYSTEMS: 5BN01-->5BN04		"7ME361" SITRANS FUS1010 OP SYSTEMS: 5BN01-->5BN02	
<p>*a = 0, 2 or 3, indicating enclosure type.*</p>									
METER INSTALLATION CONFIGURATION		SINGLE CHANNEL		DUAL CHANNEL		DUAL CHANNEL		DUAL CHANNEL	
TERMINAL	SIGNAL	DEFINITION	DESCRIPTION	FUNCTION	FUNCTION	FUNCTION	FUNCTION	FUNCTION	FUNCTION
1	RELAY 1 N.O. (-7AKS ONLY)	0-10 VOLT OUTPUT	METER PROCESS VARIABLES ARE ASSIGNED TO INDIVIDUAL OUTPUTS; UNDER MENU CONTROL.	COMMUNICATIONS PORT	COMMUNICATIONS PORT	COMMUNICATIONS PORT	COMMUNICATIONS PORT	COMMUNICATIONS PORT	COMMUNICATIONS PORT
2	RELAY 1 N.C. (-7AKS ONLY)	0-10 VOLT OUTPUT	METER PROCESS VARIABLES ARE ASSIGNED TO INDIVIDUAL OUTPUTS; UNDER MENU CONTROL.	COMMUNICATIONS PORT	COMMUNICATIONS PORT	COMMUNICATIONS PORT	COMMUNICATIONS PORT	COMMUNICATIONS PORT	COMMUNICATIONS PORT
3	RELAY 1 COM	REF. GROUND	0 TO 5000HZ FREQUENCY OUTPUT.	COMMUNICATIONS PORT	COMMUNICATIONS PORT	COMMUNICATIONS PORT	COMMUNICATIONS PORT	COMMUNICATIONS PORT	COMMUNICATIONS PORT
4	RELAY 2 N.O. (-7AKS ONLY)	4-20mA OUTPUT 1	ASSIGNABLE CHASSIS GROUND	COMMUNICATIONS PORT	COMMUNICATIONS PORT	COMMUNICATIONS PORT	COMMUNICATIONS PORT	COMMUNICATIONS PORT	COMMUNICATIONS PORT
5	RELAY 2 N.C. (-7AKS ONLY)	4-20mA OUTPUT 2	ASSIGNABLE CHASSIS GROUND	COMMUNICATIONS PORT	COMMUNICATIONS PORT	COMMUNICATIONS PORT	COMMUNICATIONS PORT	COMMUNICATIONS PORT	COMMUNICATIONS PORT
6	RELAY 2 COM	ISOLATED RETURN	ASSIGNABLE CHASSIS GROUND	COMMUNICATIONS PORT	COMMUNICATIONS PORT	COMMUNICATIONS PORT	COMMUNICATIONS PORT	COMMUNICATIONS PORT	COMMUNICATIONS PORT
7	RELAY 3 N.O. (-7AKS ONLY)	ISOLATED RETURN	ASSIGNABLE CHASSIS GROUND	COMMUNICATIONS PORT	COMMUNICATIONS PORT	COMMUNICATIONS PORT	COMMUNICATIONS PORT	COMMUNICATIONS PORT	COMMUNICATIONS PORT
8	RELAY 3 N.C. (-7AKS ONLY)	ISOLATED RETURN	ASSIGNABLE CHASSIS GROUND	COMMUNICATIONS PORT	COMMUNICATIONS PORT	COMMUNICATIONS PORT	COMMUNICATIONS PORT	COMMUNICATIONS PORT	COMMUNICATIONS PORT
9	RELAY 3 COM	ISOLATED RETURN	ASSIGNABLE CHASSIS GROUND	COMMUNICATIONS PORT	COMMUNICATIONS PORT	COMMUNICATIONS PORT	COMMUNICATIONS PORT	COMMUNICATIONS PORT	COMMUNICATIONS PORT
10	RELAY 4 N.O. (-7AKS ONLY)	ISOLATED RETURN	ASSIGNABLE CHASSIS GROUND	COMMUNICATIONS PORT	COMMUNICATIONS PORT	COMMUNICATIONS PORT	COMMUNICATIONS PORT	COMMUNICATIONS PORT	COMMUNICATIONS PORT
11	RELAY 4 N.C. (-7AKS ONLY)	ISOLATED RETURN	ASSIGNABLE CHASSIS GROUND	COMMUNICATIONS PORT	COMMUNICATIONS PORT	COMMUNICATIONS PORT	COMMUNICATIONS PORT	COMMUNICATIONS PORT	COMMUNICATIONS PORT
12	RELAY 4 COM	ISOLATED RETURN	ASSIGNABLE CHASSIS GROUND	COMMUNICATIONS PORT	COMMUNICATIONS PORT	COMMUNICATIONS PORT	COMMUNICATIONS PORT	COMMUNICATIONS PORT	COMMUNICATIONS PORT
13	RELAY 4 N.O. (-7AKS ONLY)	ISOLATED RETURN	ASSIGNABLE CHASSIS GROUND	COMMUNICATIONS PORT	COMMUNICATIONS PORT	COMMUNICATIONS PORT	COMMUNICATIONS PORT	COMMUNICATIONS PORT	COMMUNICATIONS PORT
14	RELAY 4 N.C. (-7AKS ONLY)	ISOLATED RETURN	ASSIGNABLE CHASSIS GROUND	COMMUNICATIONS PORT	COMMUNICATIONS PORT	COMMUNICATIONS PORT	COMMUNICATIONS PORT	COMMUNICATIONS PORT	COMMUNICATIONS PORT
15	RELAY 4 COM	ISOLATED RETURN	ASSIGNABLE CHASSIS GROUND	COMMUNICATIONS PORT	COMMUNICATIONS PORT	COMMUNICATIONS PORT	COMMUNICATIONS PORT	COMMUNICATIONS PORT	COMMUNICATIONS PORT



Siemens Energy & Automation, Inc.
Process Instrumentation Business Unit
CoC Ultrasonic Flow - Heppauge, Long Island, NY 11788

INSTALLATION WIRING EXPANDED I/O MODULE

DO NOT SCALE THIS DRAWING	CONTRACT NO.
UNLESS OTHERWISE SPECIFIED: DIMENSIONS ARE IN INCHES. TOLERANCES ON-	DR _____ DATE 8/30/00
INCHES (MM) ± .1	CHK _____ DATE _____
MATERIAL:	ENG _____ DATE _____
FINISH:	PRD _____ DATE _____
	APPD _____ DATE _____
	CERTIFIED _____ DATE _____

SIZE	CODE IDENT NO.	REV.
C 21614	1010N-7-7	05
SCALE: NONE	WT.	SHEET 2 OF 2

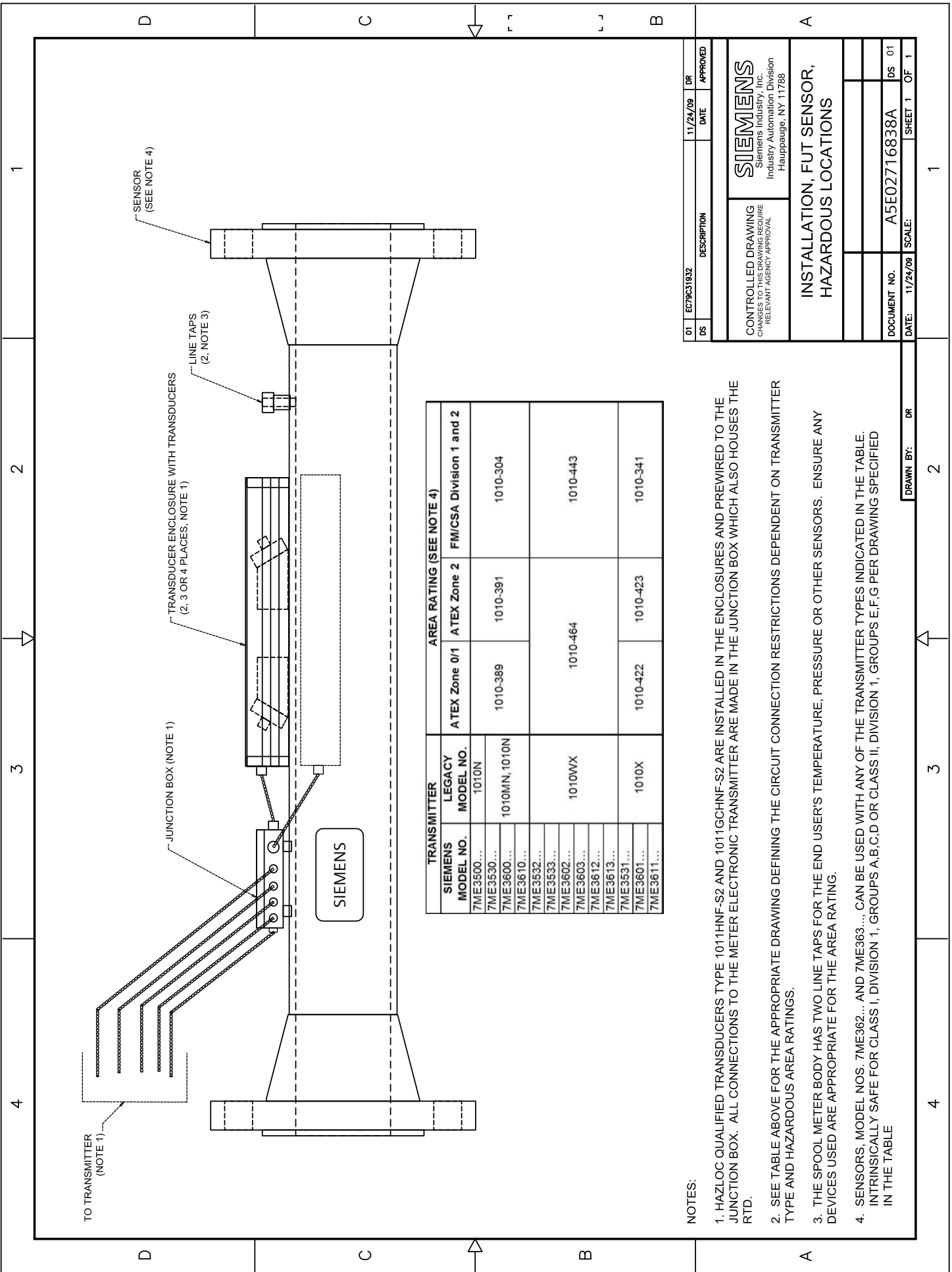

TRANSMITTER		AREA RATING (SEE NOTE 4)	
SIEMENS MODEL NO.	LEGACY MODEL NO.	ATEX Zone 0/1	ATEX Zone 2
7ME3500...	1010N		
7ME3530...			
7ME3600...	1010MN, 1010N	1010-389	1010-391
7ME3610...			1010-304
7ME3532...			
7ME3533...			
7ME3602...			
7ME3603...			
7ME3612...	1010WX		1010-464
7ME3613...			
7ME3531...		1010-422	1010-423
7ME3601...	1010X		
7ME3611...			1010-341

NOTES:

- HAZLOC QUALIFIED TRANSDUCERS TYPE 1011HNF-S2 AND 1011GCHNF-S2 ARE INSTALLED IN THE ENCLOSURES AND PREWIRED TO THE JUNCTION BOX. ALL CONNECTIONS TO THE METER ELECTRONIC TRANSMITTER ARE MADE IN THE JUNCTION BOX WHICH ALSO HOUSES THE RTD.
- SEE TABLE ABOVE FOR THE APPROPRIATE DRAWING DEFINING THE CIRCUIT CONNECTION RESTRICTIONS DEPENDENT ON TRANSMITTER TYPE AND HAZARDOUS AREA RATINGS.
- THE SPOOL METER BODY HAS TWO LINE TAPS FOR THE END USER'S TEMPERATURE, PRESSURE OR OTHER SENSORS. ENSURE ANY DEVICES USED ARE APPROPRIATE FOR THE AREA RATING.
- SENSORS, MODEL NOS. 7ME362... AND 7ME363... CAN BE USED WITH ANY OF THE TRANSMITTER TYPES INDICATED IN THE TABLE. INTRINSICALLY SAFE FOR CLASS I, DIVISION 1, GROUPS A, B, C, D OR CLASS II, DIVISION 1, GROUPS E, F, G PER DRAWING SPECIFIED IN THE TABLE

DS	DESCRIPTION	DATE	DR
01	EC79C31932	11/24/09	APPROVED
SIEMENS Siemens Industry, Inc. Industry Automation Division Hauptpaugue, NY 11788			
CONTROLLED DRAWING CHANGES TO THIS DRAWING REQUIRE RELEVANT AGENCY APPROVAL			
INSTALLATION, FUT SENSOR, HAZARDOUS LOCATIONS			
DOCUMENT NO.	A5E02716838A	DS	01
DATE:	11/24/09	SCALE:	SHEET 1 OF 1

DRAWN BY: DR

Glossary

Active Memory

Section of RAM allocated for active site parameters (all current values). The flowmeter receives site-specific operating instructions from Active Memory.

Alphanumeric Field

An 8-character data entry field that allows you to specify a Site Name or a Security code.

Arrow Keys

Use the <Up, Down, Left and Right> Arrows to navigate through the Installation Menu in their respective directions. The <Up or Down> Arrows allow you also to scroll through option list items.

Asterisk

Refers to the marker used in the Installation Menu to indicate a current option list selection. When you access an option list, you can move the asterisk with the <Up or Down> Arrows to a new selection, then press <ENT> to select the item.

CLR (Clear) Key

Use the <CLR> key to erase a numeric value or clear a selection from a multiple select option list.

Cursor

This refers to the highlighted text and the arrow cursor that you move via the arrow direction when navigating through menus or menu cells.

Data Entry

Refers to data entered into a menu cell (either numeric or option list selection).

Datalogger Memory

Memory segment that stores data items logged during operation. You can view the Datalogger contents either on-screen or transmit it to an external device via the RS-232 serial port. The amount of Datalogger memory depends on how many sites reside in Site Storage memory.

ENT (Enter) Key

Use the <ENT> key to store a current numeric value or option list item.

Flowmeter

Refers to the flowmeter itself (the transmitter and sensors combined).

Graphic Screen

Refers to the integral display screen.

Initial Makeup

An internal process performed during installation, where the flowmeter acquires its receive signal and enhances other parameters for optimal operation at a site.

In-process Makeup

An internal process where the flowmeter recovers its Initial Makeup parameters after a fault condition interrupts operation.

Installation Menu

The flow meter's overall menu structure. It allows you to define all aspects of operation for the flowmeter.

Interface m/s

Refers to an alarm function that declares the passage of a liquid or gas interface by a comparison of the relative sonic velocities of the two liquids or two gases.

LAPTOT

Refers to a system function that freezes the Totalizer display, while the Totalizer continues to update its registers.

Local Display

Refers to the transmitter integral display screen.

Menu

Sub-sections of the Installation Menu that allow you to define specific operational functions (e.g., RS-232 Setup).

Menu Cell

A location within a menu where you define either a single numeric value or option list selection that supports the Sub-Menu's function. Certain view-only menu cells show reference data appropriate to the current application.

NEGFLOW

Totalizer mode for negative flow total only.

NETFLOW

Totalizer mode that combines positive and negative flow totals.

NOTOT

System function that disables the internal Totalizer.

Number Index

Computed sensor spacing index based on the estimated sonic velocity measurement. This Index can not be overridden by installer.

Numeric Data

Refers to a value entered into a menu cell. An example would be the pipe outer diameter.

Numeric Entry

Refers to a number you type into menu cell that stores numeric data.

Numeric Keys

Use the Numeric keys to type a numeric value where appropriate.

OpSys ROM

The Read-Only-Memory that stores its basic operating instructions and permanent defaults.

Option List

Lists of options presented at menu cells that allow you to select either a single item or multiple items (depending on the function that the menu cell controls).

Parameters

Refers to value (either numeric or list selection) stored in a menu cell.

POSFLOW

Totalizer mode for positive flow total only.

Register

Refers to a memory location used by the flowmeter to store data such as the flow total, etc.

RTD

Resistive Temperature Device. Temperature sensors used with energy flow of mass flow systems.

Sensor

Refers to entire spool piece in some instances. Flow sensors that the flowmeter uses to measure the flow rate. Also called transducers and abbreviated as Xdcr

Site Name

A user-entered name that the flowmeter associates with a stored Site Setup. You retrieve a particular Site by selecting its name from a site name list.

Site Setup

A collection of parameters used by the flowmeter to service a specific site (or location). The flowmeter allows you to store several independent Site Setups.

Site Storage Memory

Section of RAM allocated for permanent data storage. This memory segment stores inactive site setups (including a backup of active site). The flow meter's Site Setup storage capacity depends on the dynamic memory allocation as dictated by each application. In addition, the flowmeter uses Site Storage Memory to store configurable operating parameters such as pipe, liquid or gas tables.

Spacing Index

Refers to the Number Index used by the flowmeter to determine the space between the upstream and downstream sensors on clamp-on systems.

Spacing Offset

Fixed sensor offset assigned by the flowmeter. This can be overridden by the installer.

TOTCNT

A Totalizer pulse count function used for Batching or Sampling.

Transducer

Also known as sensor.

Vaer

The flow meter's aeration percent output.

Vps

The sonic propagation velocity of a pipe.

Vs

The sonic velocity of a liquid or gas.

Index

C

CE marked equipment, 12
CE-mark, 12
Customer Support Hotline, 117

D

Decontamination, 118

F

Flow meter Types, 29

H

Hazardous area safety requirements, 13
History, 9
Hotline, 117

I

Internet
 Contact person, 118
 Support, 117
Introduction, 9

L

Lithium batteries
 Safety, 12

M

Maintenance, 117

P

Pipe Mounting, 35

R

Return procedures, 118

S

Safety notes, 11
Sensor Label Markings, 36
Service, 117
SITRANS FUT1010 Transmitters, 24
SmartSlew, 102
Support, 117

T

Time Average, 102
TransLoc™ Sensor Mounting System, 21
Transmitter, 24
Typical Applications, 26
Typical Industries Serviced, 26

V

Versions, 23

W

Wall Mounting, 34
Wide Beam Transmission, 31

Get more information:

www.siemens.com/flow

Siemens Industry, Inc.
Industry Automation Division
CoC Ultrasonic Flow
Hauppauge, NY 11788
USA

Subject to change without prior notice
Order No.: A5E02639185-03
Printed in the USA
© Siemens AG 03.2011

www.siemens.com/processinstrumentation

We have reviewed the contents of this publication to ensure consistency with the hardware and software described. Since variance cannot be precluded entirely, we cannot guarantee full consistency. However, the information in this publication is reviewed regularly and any necessary corrections are included in subsequent editions. Responsibility for suitability and intended use of this instrument rests solely with the user.