

SIEMENS



SITRANS F

Coriolis Flowmeters
SITRANS FC430 with HART

Operating Instructions

Edition

06/2012

Answers for industry.

SIEMENS

SITRANS F

Coriolis Flowmeters SITRANS FC430 with HART

Operating Instructions

<u>Introduction</u>	1
<u>Safety notes</u>	2
<u>Description</u>	3
<u>Installing/mounting</u>	4
<u>Connecting</u>	5
<u>Commissioning</u>	6
<u>Operating</u>	7
<u>Functions</u>	8
<u>Custody Transfer</u>	9
<u>Alarms and system messages</u>	10
<u>Service and maintenance</u>	11
<u>Troubleshooting/FAQs</u>	12
<u>Technical data</u>	13
<u>Spare parts/Accessories</u>	14
<u>Dimensions and weight</u>	15
<u>LUI menu structure</u>	A
<u>HART commands</u>	B
<u>Zero point adjustment</u>	C

These Operating Instructions apply to Siemens products SITRANS FC430 with order codes commencing 7ME4613, 7ME4603, 7ME4623, 7ME4610, 7ME4620, 7ME4710, and 7ME4713

Legal information

Warning notice system

This manual contains notices you have to observe in order to ensure your personal safety, as well as to prevent damage to property. The notices referring to your personal safety are highlighted in the manual by a safety alert symbol, notices referring only to property damage have no safety alert symbol. These notices shown below are graded according to the degree of danger.

⚠ DANGER
indicates that death or severe personal injury will result if proper precautions are not taken.
⚠ WARNING
indicates that death or severe personal injury may result if proper precautions are not taken.
⚠ CAUTION
indicates that minor personal injury can result if proper precautions are not taken.
NOTICE
indicates that property damage can result if proper precautions are not taken.

If more than one degree of danger is present, the warning notice representing the highest degree of danger will be used. A notice warning of injury to persons with a safety alert symbol may also include a warning relating to property damage.

Qualified Personnel

The product/system described in this documentation may be operated only by **personnel qualified** for the specific task in accordance with the relevant documentation, in particular its warning notices and safety instructions. Qualified personnel are those who, based on their training and experience, are capable of identifying risks and avoiding potential hazards when working with these products/systems.

Proper use of Siemens products

Note the following:

⚠ WARNING
Siemens products may only be used for the applications described in the catalog and in the relevant technical documentation. If products and components from other manufacturers are used, these must be recommended or approved by Siemens. Proper transport, storage, installation, assembly, commissioning, operation and maintenance are required to ensure that the products operate safely and without any problems. The permissible ambient conditions must be complied with. The information in the relevant documentation must be observed.

Trademarks

All names identified by ® are registered trademarks of Siemens AG. The remaining trademarks in this publication may be trademarks whose use by third parties for their own purposes could violate the rights of the owner.

Disclaimer of Liability

We have reviewed the contents of this publication to ensure consistency with the hardware and software described. Since variance cannot be precluded entirely, we cannot guarantee full consistency. However, the information in this publication is reviewed regularly and any necessary corrections are included in subsequent editions.

Table of contents

1	Introduction.....	9
1.1	History.....	9
1.2	Items supplied.....	9
1.3	Checking the consignment.....	11
1.4	Device identification.....	11
2	Safety notes.....	19
2.1	Laws and directives.....	19
2.2	Installation in hazardous locations.....	20
2.3	Certificates.....	23
3	Description.....	25
3.1	System configuration.....	26
3.2	Design.....	27
3.3	Features.....	32
3.4	HART Communication Interface.....	34
3.5	Theory of operation.....	37
4	Installing/mounting.....	39
4.1	Introduction.....	39
4.2	Strong vibrations.....	39
4.3	Sensor installation.....	39
4.3.1	Installation safety precautions.....	39
4.3.2	Determining a location	41
4.3.3	Orientation of the sensor.....	42
4.3.4	Mounting the sensor.....	44
4.3.5	Mounting a pressure guard.....	46
4.4	Transmitter installation.....	48
4.4.1	Introduction.....	48
4.4.2	Wall mounting.....	49
4.4.3	Pipe mounting.....	49
4.4.4	Mounting the transmitter.....	50
4.4.5	Turning the transmitter.....	50
4.4.6	Turning the local display.....	52
5	Connecting.....	53
5.1	General safety requirements.....	53
5.2	Wiring in hazardous locations.....	54
5.3	Cable requirements.....	54

5.4	Safety notes for connecting.....	55
5.5	Step 1: Connecting the sensor and the transmitter.....	56
5.6	Lack of equipotential bonding.....	59
5.7	Step 2: Preparing for the transmitter connections.....	59
5.8	Step 3: Connecting the power supply.....	63
5.9	Missing PE/ground connection.....	65
5.10	Step 4a: Connecting the current output HART (channel 1).....	65
5.11	Step 4b: Connecting the inputs and outputs (channels 2 to 4).....	66
5.12	Step 5: Finishing the transmitter connection.....	69
6	Commissioning.....	71
6.1	General requirements.....	71
6.2	Warnings.....	71
6.3	Commissioning via LUI.....	72
6.3.1	Introduction.....	72
6.3.2	Overview.....	72
6.3.3	Quick Start.....	73
6.3.4	Zero point adjustment.....	74
6.4	Commissioning with PDM.....	75
6.4.1	Operating via SIMATIC PDM.....	76
6.4.2	Functions in SIMATIC PDM.....	76
6.4.3	Features of SIMATIC PDM Rev. 6.1, SP4.....	76
6.4.4	Initial setup.....	76
6.4.5	Configuring a new device.....	78
6.4.6	Wizard - Quick Start via PDM.....	78
6.4.7	Wizard - Zero Point adjustment.....	86
6.4.8	Changing parameter settings using SIMATIC PDM.....	87
6.4.9	Parameters accessed via drop-down menus.....	88
6.4.10	Zero point adjustment.....	89
6.4.11	Process variables.....	91
7	Operating.....	93
7.1	Local User Interface (LUI).....	93
7.1.1	Display view structure.....	94
7.1.2	Access control.....	98
7.1.3	Operation view.....	98
7.1.4	Navigation view.....	104
7.1.5	Parameter view.....	110
8	Functions.....	113
8.1	Process values.....	113
8.2	Zero point adjustment.....	114
8.3	Low flow cut-off.....	116
8.4	Empty tube monitoring.....	116

8.5	Process noise damping.....	117
8.6	Inputs and outputs.....	119
8.6.1	Current output.....	120
8.6.2	Pulse output.....	125
8.6.3	Frequency output.....	127
8.6.4	Status output.....	128
8.6.4.1	Alarm status.....	128
8.6.5	Control output.....	129
8.6.6	Input.....	129
8.6.6.1	Input options.....	129
8.7	Totalizers.....	129
8.8	Dosing.....	130
8.8.1	Valve control configuration.....	131
8.8.2	Dosing operation.....	137
8.8.3	Fault handling.....	137
8.9	SensorFlash.....	138
8.10	Simulation.....	138
8.11	Maintenance.....	139
9	Custody Transfer.....	141
9.1	Introduction.....	141
9.2	Operating conditions.....	141
9.3	Verification.....	141
9.4	Setting up custody transfer mode.....	143
9.5	Parameter protection in custody transfer mode.....	146
9.6	Disabling custody transfer mode.....	148
10	Alarms and system messages.....	151
10.1	Overview of messages and symbols	151
10.2	Alarm messages.....	153
11	Service and maintenance.....	161
11.1	Maintenance.....	161
11.2	Service information.....	161
11.3	Recalibration.....	161
11.4	Technical support.....	162
11.5	Transportation and storage.....	163
11.6	Cleaning.....	163
11.7	Maintenance work.....	164
11.8	Repair.....	165
11.8.1	Unit repair.....	165
11.9	Return and disposal.....	166

11.9.1	Return procedures.....	166
11.9.2	Device disposal.....	167
12	Troubleshooting/FAQs.....	169
12.1	Diagnosing with PDM.....	169
12.2	Troubleshooting sensor-related problems.....	169
12.2.1	Step 1: Inspecting the application.....	170
12.2.2	Step 2: Performing a zero point adjustment.....	170
12.2.3	Step 3: Calculating the measurement error.....	170
12.2.4	Step 4: Improving the application.....	172
13	Technical data.....	175
13.1	Function and system design.....	175
13.2	SensorFlash.....	175
13.3	Process variables.....	175
13.4	Bus communication.....	176
13.5	Performance.....	176
13.6	Rated operating conditions.....	178
13.7	Pressure drop curves.....	179
13.8	Pressure - temperature ratings.....	179
13.9	Design.....	180
13.10	Inputs and outputs.....	181
13.11	Local User Interface.....	183
13.12	Power supply.....	183
13.13	Cables and cable entries.....	183
13.14	Installation torques.....	185
13.15	Certificates and approvals HART.....	186
13.16	PED.....	188
13.16.1	Division according to the danger potential.....	188
13.16.2	Division of media (liquid/gaseous) into the fluid groups.....	189
13.16.3	Conformity assesment.....	190
13.16.4	Diagrams.....	191
14	Spare parts/Accessories.....	193
14.1	Ordering.....	193
14.2	Replaceable components.....	193
15	Dimensions and weight.....	197
15.1	Sensor dimensions.....	197
15.2	Lengths matrix.....	198
15.3	Transmitter dimensions.....	201
15.4	Mounting bracket.....	202

A	LUI menu structure.....	203
A.1	Menu structure overview.....	203
A.2	Main menu.....	203
A.3	Menu item 1.3: Massflow.....	204
A.4	Menu item 1.4: Volumeflow.....	205
A.5	Menu item 1.5: Density.....	205
A.6	Menu item 1.6 Fluid temperature.....	205
A.7	Menu item 1.7: Fraction.....	205
A.8	Menu item 1.8: Totalizer 1.....	206
A.9	Menu item 1.9: Totalizer 2.....	206
A.10	Menu item 1.10: Totalizer 3.....	206
A.11	Menu item 2.1: Basic settings.....	207
A.12	Menu item 2.2: Process values.....	207
A.13	Menu item 2.3: Totalizer.....	209
A.14	Menu item 2.4: Inputs/Outputs.....	210
A.15	Menu item 2.5: Dosing.....	214
A.16	Menu item 2.6: Zero point adjustment.....	217
A.17	Menu item 2.7: Safe operation.....	217
A.18	Menu item 2.8: Display.....	218
A.19	Menu item 3.1: Identification.....	219
A.20	Menu item 3.2: Alarms.....	220
A.21	Menu item 3.3: Maintenance.....	220
A.22	Menu item 3.4: Diagnostics.....	221
A.23	Menu item 3.5: Characteristics.....	221
A.24	Menu item 3.6: SensorFlash.....	222
A.25	Menu item 3.7: Simulate.....	222
A.26	Menu item 3.8: Self test.....	224
A.27	Menu item 3.9: Dosing test.....	224
A.28	Menu item 4.6: Mapping of variables.....	224
A.29	Menu item 4.7: HART units.....	225
A.30	Menu item 5.1: Access management.....	225
B	HART commands.....	227
B.1	Universal commands.....	227
B.2	Common practice commands.....	227

Table of contents

C	Zero point adjustment.....	229
	Glossary.....	233
	Index.....	235

Introduction

These instructions contain all information required to commission and use the device. It is your responsibility to read the instructions carefully prior to installation and commissioning. In order to use the device correctly, first review its principle of operation.

The instructions are aimed at persons mechanically installing the device, connecting it electronically, configuring the parameters and commissioning it, as well as service and maintenance engineers.

The contents of this manual shall not become part of or modify any prior or existing agreement, commitment or legal relationship. The sales contract contains all obligations on the part of Siemens as well as the complete and solely applicable warranty conditions. Any statements regarding device versions described in the manual do not create new warranties or modify the existing warranty.

The content reflects the technical status at the time of publishing. Siemens reserves the right to make technical changes in the course of further development.

1.1 History

The following table shows major changes in the documentation compared to the previous edition.

Edition	Remarks	SW version	FW revision
03/2012	First edition	<ul style="list-style-type: none"> • SIMATIC PDM driver 1.00.00 	
06/2012	Second edition CT chapter included	<ul style="list-style-type: none"> • SIMATIC PDM driver 1.00.00 	<ul style="list-style-type: none"> • Standard version: <ul style="list-style-type: none"> – Compact: 03.00.00-10 – Remote: 02.00.00-30 • CT version: <ul style="list-style-type: none"> – Compact: 03.00.00-11 – Remote: 02.00.00-31

1.2 Items supplied

The device can be delivered as either a compact or a remote system.

Compact system

- SITRANS FC430 sensor and compact mounted transmitter
- Packet of cable glands
- Quick Start guide
- CD containing software, certificates and device manuals

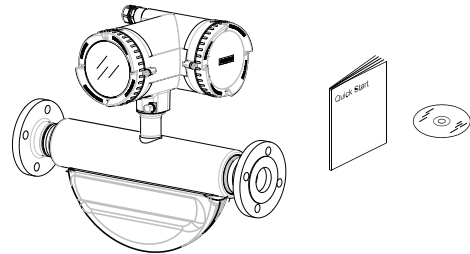

83L506

Remote system

Remote with M12 plug connection

- SITRANS FCS400 sensor
- SITRANS FCT030 transmitter with M12 socket assembled
- Mounting bracket and cushion pad
- Sensor cable with M12 connector
- Packet of cable glands
- Quick Start guide
- CD containing software, certificates and device manuals

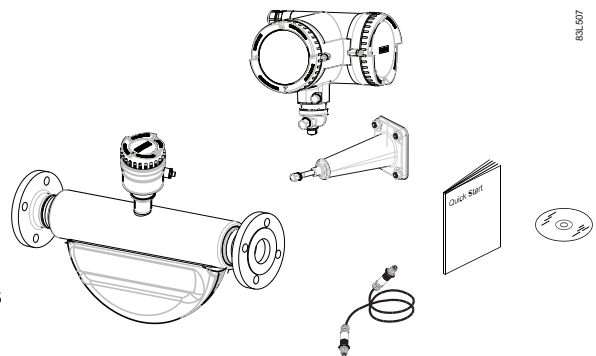

83L507

Remote with sensor terminal housing

- SITRANS FCS400 sensor
- SITRANS FCT030 transmitter with terminal housing assembled
- Mounting bracket and cushion pad
- Sensor cable
- Packet of cable glands
- Quick Start guide
- CD containing software, certificates and device manuals

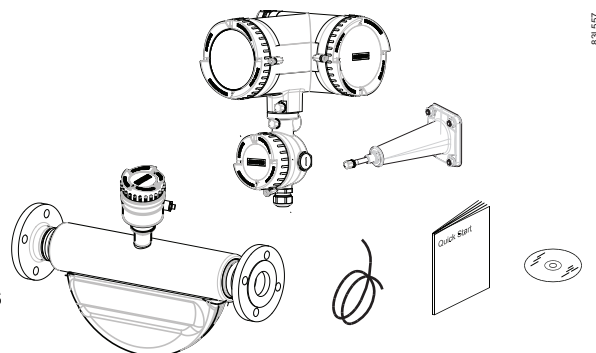

83L557

Note

Scope of delivery may vary, depending on version and add-ons. Make sure the scope of delivery, and the information on the nameplate corresponds to your order and the delivery note.

Inspection

1. Check for visual mechanical damage due to possible improper handling during shipment. All claims for damage are to be made promptly to the carrier.
2. Make sure the scope of delivery, and the information on the type plate corresponds to your order and the delivery note.

1.3 Checking the consignment

1. Check the packaging and the device for visible damage caused by inappropriate handling during shipping.
2. Report any claims for damages immediately to the shipping company.
3. Retain damaged parts for clarification.
4. Check the scope of delivery by comparing the shipping documents with your order for correctness and completeness.

 WARNING**Using a damaged or incomplete device**

Danger of explosion in hazardous areas.

- Do not use any damaged or incomplete devices.

1.4 Device identification

Each part of the FC430 Coriolis flowmeter has three nameplate types showing the following information:

- product identification
- product specifications
- certificates and approvals

Note**Identification**

Identify your device by comparing your ordering data with the information on the product and specification nameplates.

FCS400 sensor identification nameplate

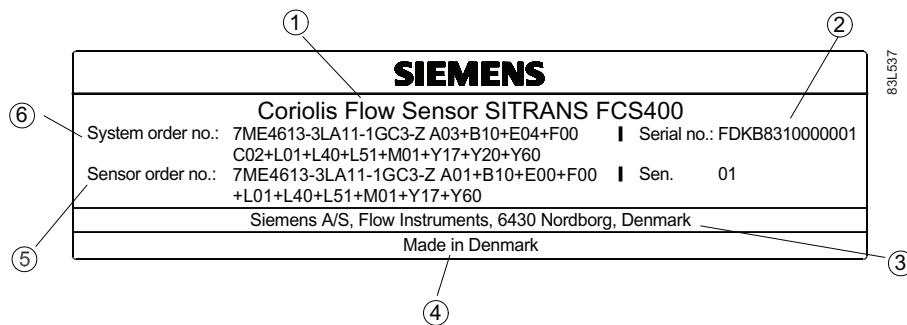

- | | | |
|---|------------------|--|
| ① | Product name | Sensor product name |
| ② | Serial no. | Flowmeter serial number |
| ③ | Manufacturer | Manufacturer name and location |
| ④ | Country | Manufacturing country |
| ⑤ | Sensor order no. | Sensor replacement order number |
| ⑥ | System order no. | Device-specific system order number (transmitter and sensor) |

Figure 1-1 FCS400 identification nameplate example

The flowmeter serial number is constructed as follows:

PPPYMDDxxxxxx

where

PPP = Production factory (Siemens Flow Instruments: FDK)

Y = Production year (for encryption, see below)

M = Production month (for encryption, see below)

DD = Production date (for encryption, see below)

xxxxxx = Sequential number

Encryption:

Calendar year (Y)	Code
1950, 1970, 1990, 2010	A
1951, 1971, 1991, 2011	B
1952, 1972, 1992, 2012	C
1953, 1973, 1993, 2013	D
1954, 1974, 1994, 2014	E
1955, 1975, 1995, 2015	F
1956, 1976, 1996, 2016	H (G)
1957, 1977, 1997, 2017	J
1958, 1978, 1998, 2018	K
1959, 1979, 1999, 2019	L
1960, 1980, 2000, 2020	M
1961, 1981, 2001, 2021	N
1962, 1982, 2002, 2022	P
1963, 1983, 2003, 2023	R

1964, 1984, 2004, 2024	S
1965, 1985, 2005, 2025	T
1966, 1986, 2006, 2026	U
1967, 1987, 2007, 2027	V
1968, 1988, 2008, 2028	W
1969, 1989, 2009, 2029	X
Month (M)	Code
January	1
February	2
March	3
April	4
May	5
June	6
July	7
August	8
September	9
October	O
November	N
December	D
Date (DD)	Code
Day 1 to 31	01 to 31 (corresponding to the actual date)

FCS400 sensor specification nameplate

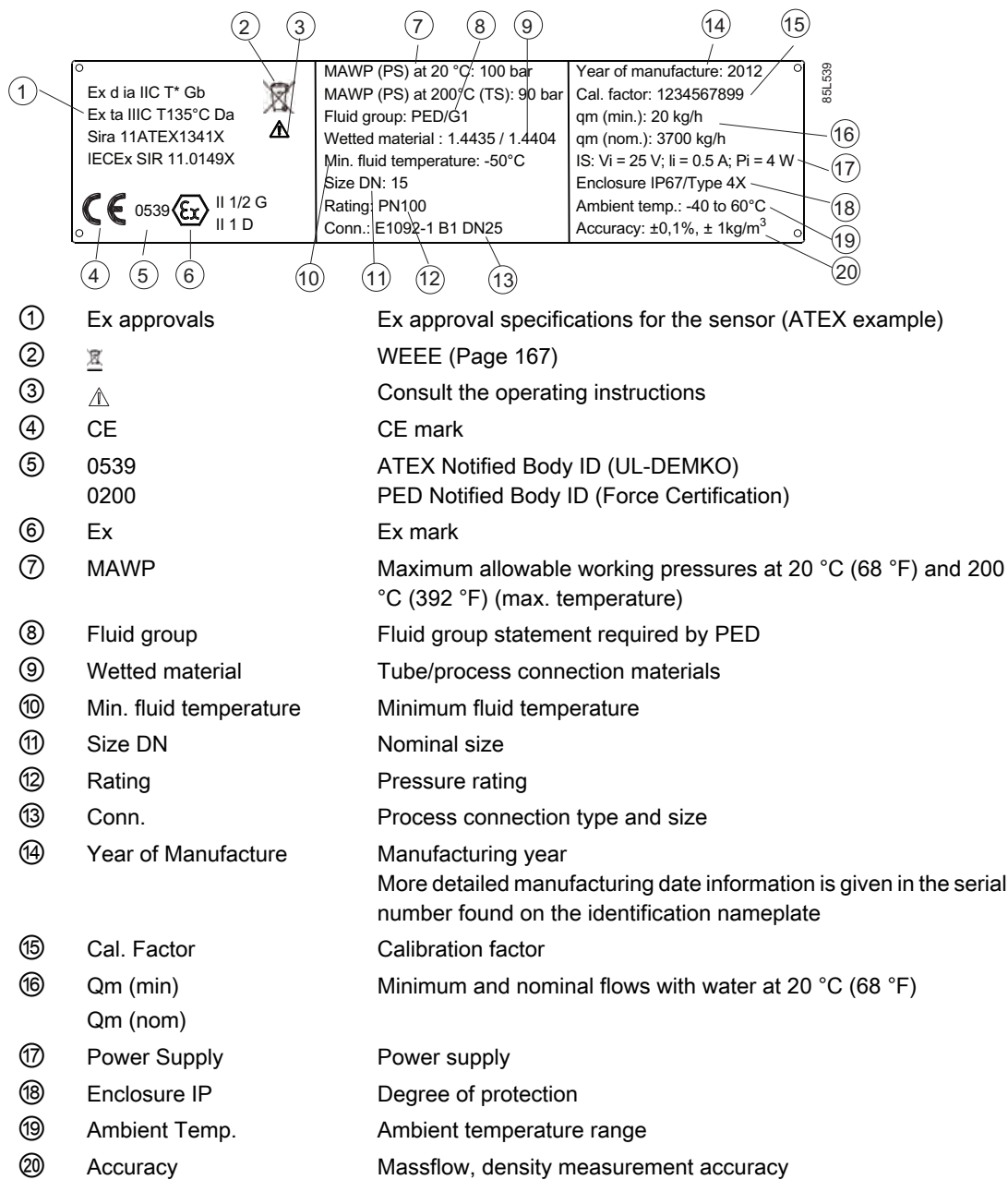
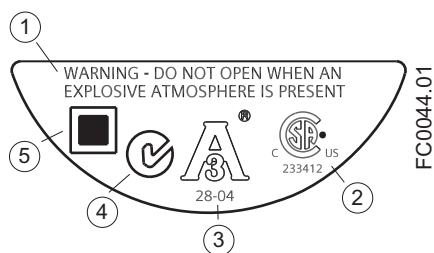

Figure 1-2 FCS400 specification nameplate example

FCS400 sensor approval nameplate



- | | | |
|---|---------|--|
| ① | WARNING | Warning: Do not open when an explosive atmosphere is present |
| ② | CSA | FM/CSA/UL approval |
| ③ | 3A | 3A logo |
| ④ | C✓ | C-tick logo |
| ⑤ | Barcode | Product-specific barcode |

Figure 1-3 FCS400 approval nameplate example

FCS400 EHEDG nameplate

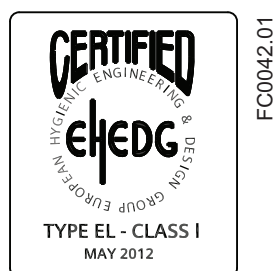

Figure 1-4 EHEDG nameplate

FCT030 transmitter identification nameplate

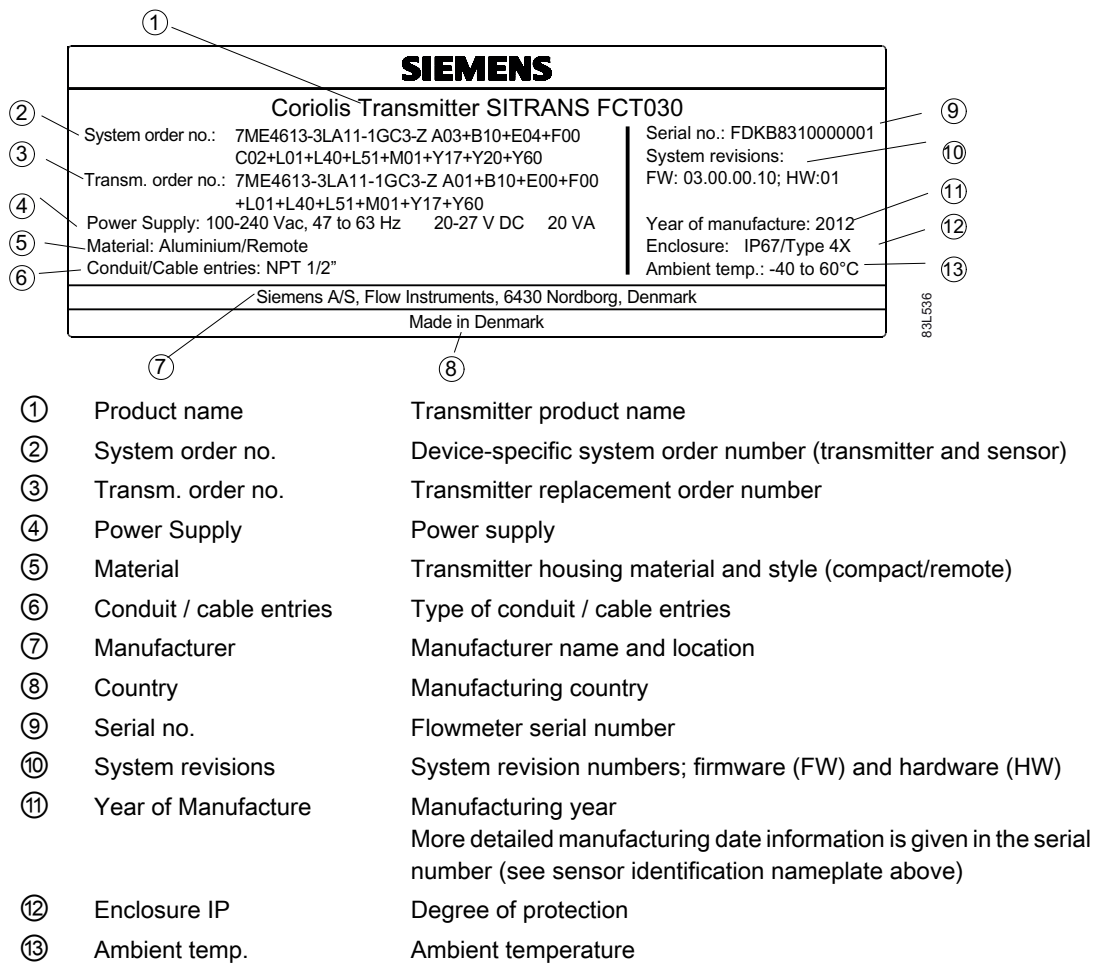

Figure 1-5 FCT030 identification nameplate example

FCT030 transmitter specification nameplate

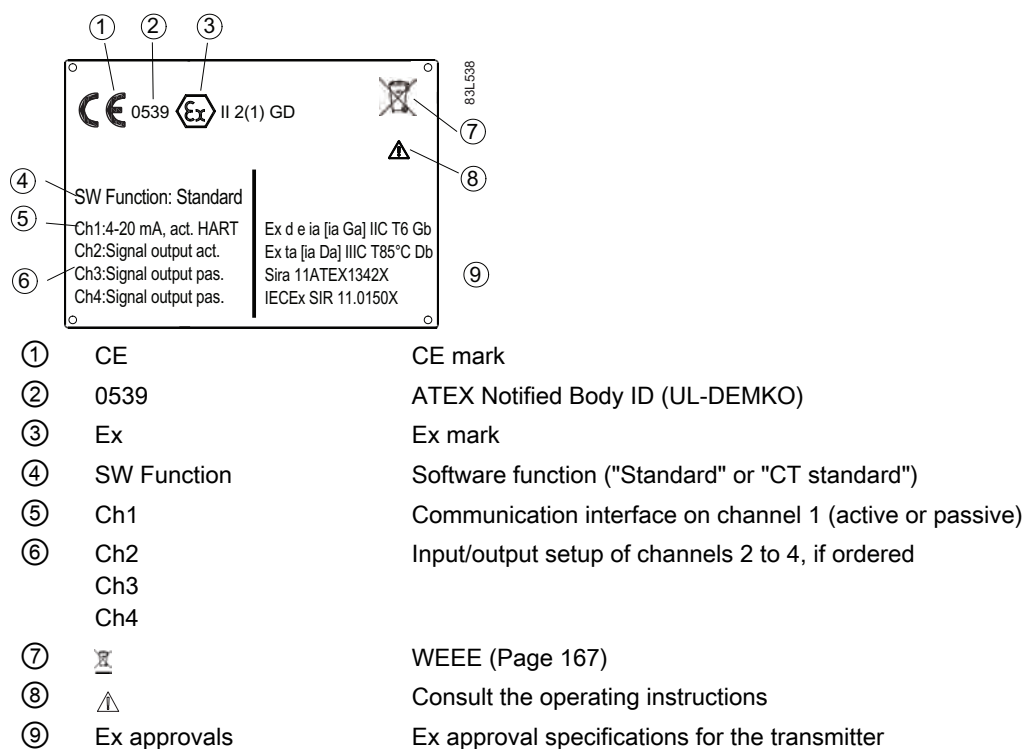

Figure 1-6 FCT030 specification nameplate example

FCT030 transmitter approval nameplate

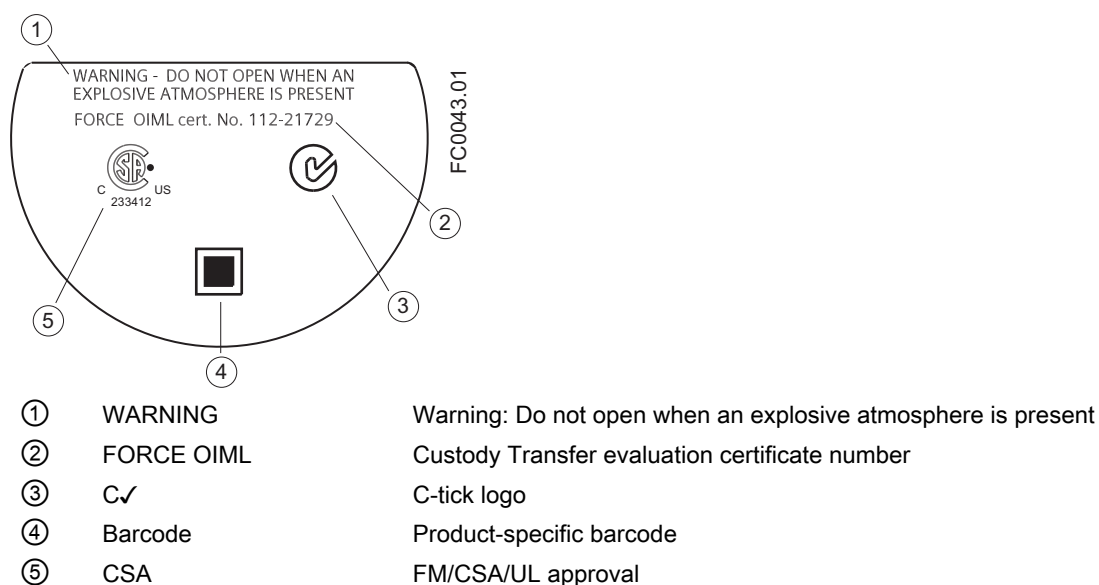

Figure 1-7 FCT030 approval nameplate example

Note

Custody transfer approval

Ensure that the "FORCE OIML cert. No." on the FCT030 transmitter approval nameplate is identical to the number on the evaluation certificate supplied with the flowmeter.

Ensure that the CT-approved flowmeter serial number is stated on both the sensor identification nameplate and on the transmitter identification nameplate ("Serial No.").

Safety notes

This device left the factory in good working condition. In order to maintain this status and to ensure safe operation of the device, observe these instructions and all the specifications relevant to safety.

Observe the information and symbols on the device. Do not remove any information or symbols from the device. Always keep the information and symbols in a completely legible state.

Symbol	Explanation
	Consult operating instructions

Note

Functional safety applications (SIL)

In case the device is used in a functional safety application, refer to the functional safety manual.

2.1 Laws and directives

Observe the test certification, provisions and laws applicable in your country during connection, assembly and operation. These include, for example:

- National Electrical Code (NEC - NFPA 70) (USA)
- Canadian Electrical Code (CEC) (Canada)

Further provisions for hazardous area applications are for example:

- IEC 60079-14 (international)
- EN 60079-14 (EC)

Conformity with European directives

The CE marking on the device symbolizes the conformity with the following European directives:

Electromagnetic compatibility EMC 2004/108/EC	Directive of the European Parliament and of the Council on the approximation of the laws of the Member States relating to electromagnetic compatibility and repealing Directive 89/336/EEC.
Low voltage directive LVD 2006/95/EC	Directive of the European Parliament and of the Council on the harmonisation of the laws of Member States relating to electrical equipment designed for use within certain voltage limits.
Atmosphère explosible ATEX 94/9/EC	Directive of the European Parliament and the Council on the approximation of the laws of the Member States concerning equipment and protective systems intended for use in potentially explosive atmospheres.
Pressure equipment directive PED 97/23/EC	Directive of the European Parliament and of the Council on the approximation of the laws of the Member States concerning pressure equipment.

The applicable directives can be found in the EC conformity declaration of the specific device. Further country or region-specific code conformity information is available on request.

 WARNING
Improper device modifications Danger to personnel, system and environment can result from modifications to the device, particularly in hazardous areas. <ul style="list-style-type: none">• Only carry out modifications that are described in the instructions for the device. Failure to observe this requirement cancels the manufacturer's warranty and the product approvals.

2.2 Installation in hazardous locations

 WARNING
Equipment used in hazardous locations Equipment used in hazardous locations must be Ex-approved and marked accordingly. It is required that the special conditions for safe use provided in the manual and in the Ex certificate are followed!

Hazardous area approvals

The device is approved for use in hazardous area and has the approvals listed below. Special conditions for safe installation and operation specified by each approval authority are included in the relevant certificate.

ATEX:

FCT030 transmitter (can be installed in Zone 1 for gas and Zone 21 for dust):
Certificate SIRA 11ATEX1342X

 II 2(1) GD
Ex d e [ia Ga] IIC T6 Gb Ta = -40°C to +60°C
Ex Tb [ia Da] IIIC T85°C Db

FCS400 sensor + DSL (can be installed in Zone 1 for gas and Zone 20 for dust):
ATEX Certificate: SIRA 11ATEX1341X

 II 1/2 GD
II 1D
Ex d ia IIC T* Gb
Ex Ta IIIC T135°C** Da

Ta = -40°C to +60°C

* Temperature class (dependent on the "Maximum Process Temperature", see "Special Conditions for Safe Use")

** See "Special Condition for Safe Use"

FC430 compact system (can be installed in Zone 1 for gas and Zone 21 for dust):
ATEX certificate SIRA 12ATEX1102X

 II 1/2 GD
Ex d e ia [ia GA] IIC T* Gb Ta = -40°C to ** °C
Ex Tb [ia Da] IIIC T 85°C Db

* Temperature class (dependent on the "Maximum Process Temperature")

** Upper ambient temperature (dependent on the "Maximum Process Temperature")

IECEX:

FCT030 transmitter (can be installed in Zone 1 for gas and Zone 21 for dust):
Certificate: IECEX SIR 11.0150X

Ex d e ia [ia Ga] IIC T6 Gb Ta = -40°C to +60°C.
Ex tb [ia Da] IIIC T85°C Db

FCS400 sensor + DSL (can be installed in Zone 1 for gas and Zone 20 for dust):
Certificate: IECEX SIR 11.0149X

Ex d ia IIC T* Gb
Ex ta IIIC T135dgC** Da
(Ta = -40°C to +60°C)

* Temperature class (dependent on the "Maximum Process Temperature", see "Conditions of Certification")

** See "Conditions of Certification"

FC430 compact system (can be installed in Zone 1 for gas and Zone 21 for dust):
Certificate: IECEX SIR 12.0040X

Ex d e ia [ia Da] IIC Gb Ta= -40 to ** °C

2.2 Installation in hazardous locations

Ex tb [ia Da] IIIC T 85°C Db

* Temperature class (dependent on the "Maximum Process Temperature")

** Upper ambient temperature (dependent on the "Maximum Process Temperature")

FM:

Transmitter (FCT030), Sensor with DSL (FCS400) and Compact (FC430):

Class I Division 1 Groups A,B,C,D T* (XP, IS)

Class II Division 1 Groups E,F,G

Class III Division 1 Group H (granulates)

Class I Zone 1 and Zone 21

Class 1 Zone 1 and Zone 20 (FCS400 remote)

*: Depends on media temperature, ambient temperature and configuration (compact or remote) (T6-T2)

Maximum temperature specifications for Ex use

FCS400 sensor with DSL and FC430 temperature classification with and without dust is related to the process temperature and ambient temperature as listed in the table below:

Table 2-1 Temperature classification

Maximum Ambient Temperature	Maximum Operating Process Temperature	Gas Temperature Classification	Dust Temperature Classification
60°C	135°C to 200°C	T3	T200°C
60°C	100°C to 135°C	T4	T135°C
60°C	Up to 100°C	T5	T100°C
48°C	Up to 85°C	T6	T85°C

Special conditions for safe use

In general, it is required that:

- The equipment shall not be opened when an explosive gas or dust atmosphere may be present or when neenergized.
- Appropriate cable connectors are used.
- Substitution of components may impair Intrinsic Safety.
- Sensor and transmitter are connected to the potential equalization throughout the hazardous area.
- EN/IEC 60079-14 is considered for installation in hazardous areas.

Further information and instructions for Ex applications can be found in the certificates on the accompanying literature CD and at www.siemens.com/FC430

 WARNING
Laying of cables Explosion hazard
Cable for use in hazardous locations must satisfy the requirements for having a proof voltage of at least 500 V AC applied between the conductor/ground, conductor/shield and shield/ground.
Connect the devices that are operated in hazardous areas as per the stipulations applicable in the country of operation.

 WARNING
Field wiring installation
Ensure that the national requirements of the country in which the devices are installed is met.

 WARNING
Loss of safety of device with type of protection "Intrinsic safety Ex i"
If the device has already been operated in non-intrinsically safe circuits or the electrical specifications have not been observed, the safety of the device is no longer ensured for use in hazardous areas. There is a danger of explosion.
<ul style="list-style-type: none">• Connect the device with type of protection "Intrinsic safety" solely to an intrinsically safe circuit.• Observe the specifications for the electrical data in the certificate and in Technical data (Page 175).

2.3 Certificates

Certificates are posted on the Internet and on the documentation CD-ROM shipped with the device.

See also

Certificates on the Internet (<http://www.siemens.com/processinstrumentation/certificates>)

Certification documents including calibration report are supplied with each sensor included on the SensorFlash. Material, pressure test, factory conformance and O₂ cleaning certificates are optional at ordering.

Description

Measurement of liquids and gases

SITRANS F C Coriolis mass flowmeters are designed for measurement of a variety of liquids and gases. The meters are multi-parameter devices offering accurate measurement of mass flow, volume flow, density, temperature and fraction, including industry-specific fractions.

Main applications

The main applications of the Coriolis flowmeter can be found in all industries, such as:

- Chemical & Pharma: detergents, bulk chemicals, acids, alkalis, pharmaceuticals, blood products, vaccines, insulin production
- Food & Beverage: dairy products, beer, wine, soft drinks, °Brix/°Plato, fruit juices and pulps, bottling, CO₂ dosing, CIP/SIP-liquids, mixture recipe control
- Automotive: fuel injection nozzle & pump testing, filling of AC units, engine consumption, paint robots
- Oil & Gas: filling of gas bottles, furnace control, test separators
- Water & Waste Water: dosing of chemicals for water treatment

Note

Use in a domestic environment

This is a Class A Group 1 equipment intended for use in industrial areas.

In a domestic environment this device may cause radio interference.

3.1 System configuration

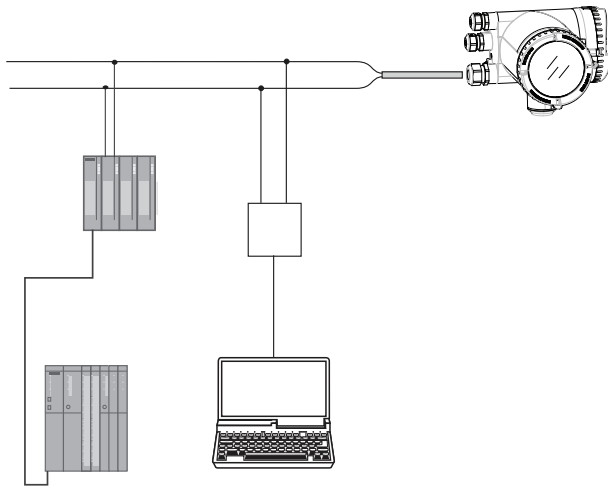

The Coriolis flowmeter can be used in a number of system configurations:

- as a field mounted transmitter and display supplied only with the necessary auxiliary power
- as part of a complex system environment, for example SIMATIC S7

3.2 Design

Versions

The SITRANS FC430 flowmeter uses the Coriolis principle to measure flow and is available in a remote and a compact version.

- Compact version: One single mechanical unit where the transmitter is directly mounted on the sensor.
- Remote version: Transmitter and sensor installed separately. The remote system is composed of SITRANS FCS400 sensor unit remotely connected to a SITRANS FCT030 transmitter. Directly mounted on the FCS400 sensor, its Digital Sensor Link (DSL) performs the signal processing of all measured signals in the sensor. The 4-wire connection between the transmitter and the sensor provides power and high-integrity digital communication between the DSL and the transmitter.

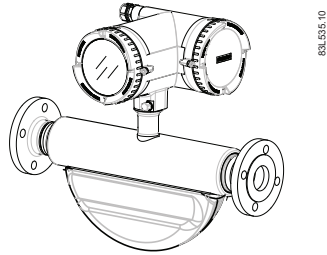

Figure 3-1 Compact versions

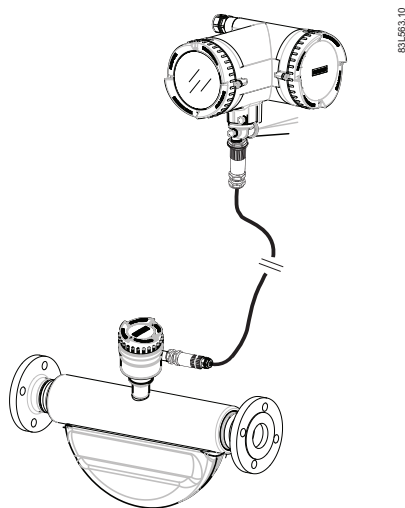

Figure 3-2 Remote version - M12 connection

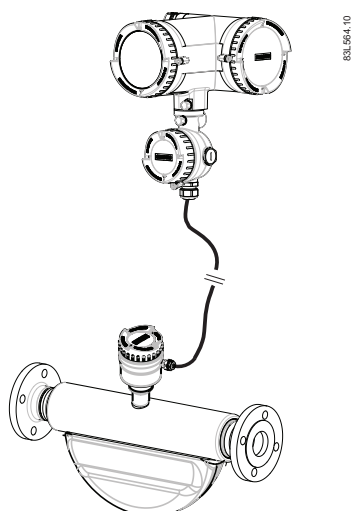

Figure 3-3 Remote version - terminated cable

Sensor design

All primary process measurement of mass and volume flow, density and process temperature are made in the DSL.

The FCS400 sensor is provided with two parallel bent tubes welded directly to the process connections at each end via a manifold. The FCS400 sensor is available in a non-safe and an intrinsically safe (IS) design.

The sensors are available in AISI 316L stainless steel. The enclosure is made of AISI 304 stainless steel and has a pressure rating of 20 bar (290 psi) for DN 15 to DN 50 and 17 bar (247 psi) for DN 80.

The sensor enclosure can be equipped with a pressure guard or flushed with dry inert gas at the threaded ports for non-hazardous applications only.

Note

Ex certification requires that the threaded ports always remain closed.

In the remote configuration, the sensor front end (DSL) is available in an aluminum enclosure with an ingress protection grade of IP67/NEMA 4X. It has a 4-wire M12 cable connection for communication and power supply.

Sensor overview

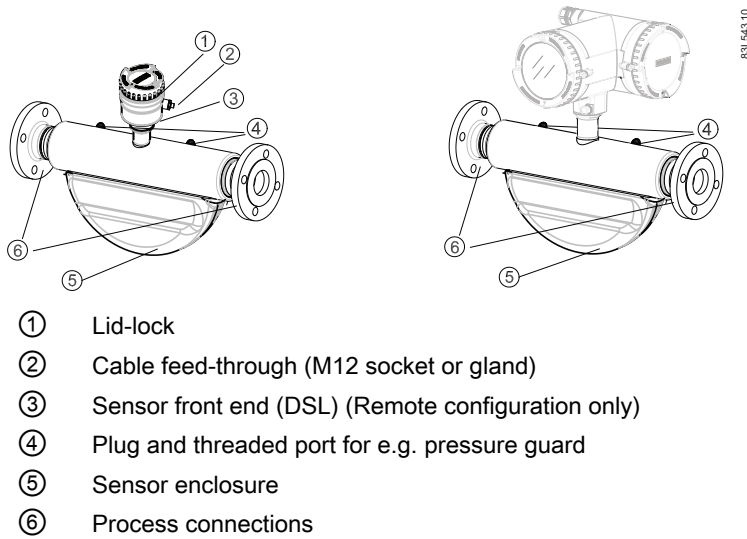

Figure 3-4 Overview, remote and compact configuration

Transmitter design

The transmitter reads the primary values from the sensor and calculates derived values. It provides four configurable I/Os, HART communication, and a local user interface (LUI). It also adds functionalities such as corrected volume flow, density, fractions, totalizers, dosing, access control, diagnostics, and configuration. The local user interface consists of a display and four buttons for user interaction.

The transmitter has a modular design with discrete, replaceable electronic modules and connection boards to maintain separation between functions and facilitate field service. All modules are fully traceable and their provenance is included in the transmitter setup.

Transmitter exploded view

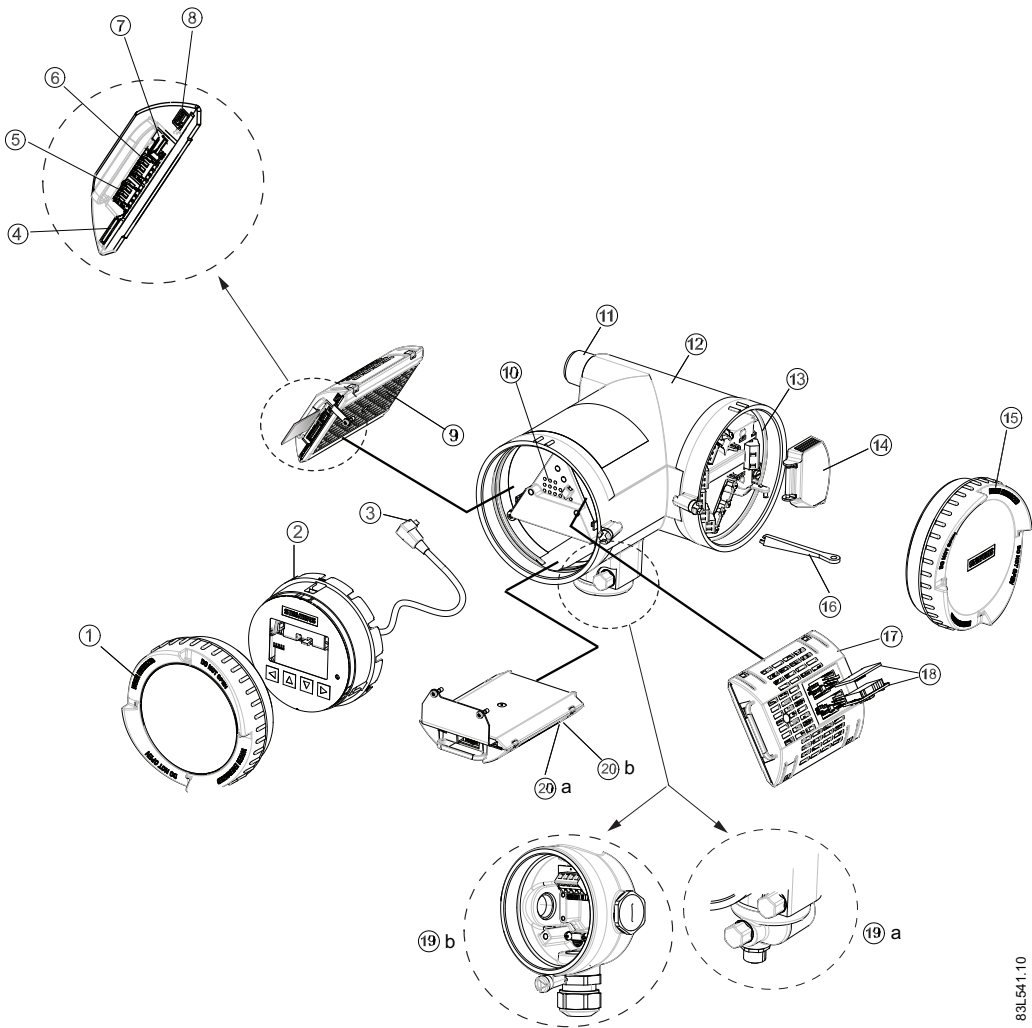

83L541.10

- ① Display cover
- ② Local user interface (LUI)
- ③ Connector for LUI
- ④ SD card (SensorFlash)
- ⑤ DIP switch (for custody transfer)
- ⑥ DIP switch (for HART)
- ⑦ LUI port
- ⑧ USB service port
- ⑨ Transmitter cassette
- ⑩ Heatsink cover for power supply module
- ⑪ Cable entry
- ⑫ Transmitter housing
- ⑬ Terminal space
- ⑭ Power supply terminal protection cover
- ⑮ Lid for terminal connections
- ⑯ Wiring tool
- ⑰ I/O cassette (optional)
- ⑱ I/O configuration keys (optional)
- ⑲ a M12 socket
- ⑲ b Terminal housing
- ⑳ a Sensor module (compact version)
- ⑳ b Sensor module (remote version)

Figure 3-5 Transmitter exploded view

3.3 Features

- The SITRANS FC430 can be used as HART slave in operation on SIEMENS SIMATIC S7/ PCS7 or third party automation systems
- Available in compact and remote design
- Full graphical Local User Interface (LUI)
- SensorFlash (SD card) for memory backup and documentation storage (certificates etc.)
- One current output
 - Channel 1: Current output with HART (can be used for safety critical applications level SIL 2 with one flowmeter or SIL 3 with dual-redundant flowmeters)
- Three optional input/output channels:
 - Channel 2: Signal output; can be parameterized for:
 - Current output (0/4-20 mA)
 - Pulse output
 - Frequency output
 - One-stage dosing output
 - Two-stage dosing output
 - Alarm, status, flow direction
 - Channels 3 and 4: Signal output (as channel 2)
 - Pulse or frequency redundancy mode (only channel 3)
 - Channels 3 and 4: Relay output; can be parameterized as:
 - One-stage dosing output
 - Two-stage dosing output
 - Alarm, status, flow direction
 - Channels 3 and 4: Signal input; can be parameterized as:
 - Dosing control
 - Totalizer control (resetting of totalizers)
 - Zero adjustment
 - Setting or freezing a frequency at the digital outputs if these are set to 'Frequency'
- Current, frequency, and pulse outputs with configurable fail safe mode
- HART communication interface (HART 7.2)
- High immunity against process noise
- Fast response to step changes in flow
- High update rate (100 Hz) on all process values

- Measurement of:
 - Massflow
 - Volumeflow
 - Corrected volumeflow (including normalized gas flows)
 - Density
 - Process media temperature
 - Fraction A (massflow or volumeflow)
 - Fraction B (massflow or volumeflow)
 - Fraction A %
 - Fraction B %
- Configurable upper and lower alarms and warning limits for all process values
- Independent low flow cut-off settings for massflow and volumeflow
- Automatic zero-point adjustment
- Process noise damping using digital signal processing (DSP).
- Three totalizers for summation of massflow, volumeflow and corrected volumeflow, depending on setting, of:
 - Massflow measurement
 - Volumeflow measurement
 - Fraction A and B measurement (massflow or volumeflow)
 - Corrected volumeflow
- Empty pipe monitoring
- Simulation of process values:
 - Massflow
 - Volumeflow
 - Corrected volumeflow
 - Density
 - Process media temperature
 - Fraction A %
 - Fraction B %
 - Frame temperature
- Simulation of all outputs
- Simulation and suppression of alarms
- Comprehensive diagnostics (NAMUR or Siemens standard) for troubleshooting and sensor checking
- Firmware update
- Use in hazardous locations according to specification

3.4 HART Communication Interface

System communication

Table 3-1 HART protocol identification data

Manufacturer ID	42 (2A Hex)	Manufacturer ID parameter
Device type	34 (22 Hex)	Device type parameter
HART protocol revision	7.2	HART protocol revision parameter
Device revision	1	Device revision parameter

Note: Version numbers and other references shown above are typical or example values.

Device description files

Available EDD drivers:

- SIMATIC PDM
- FDT/DTM
- AMS suite
- 375 Field Communicator

The drivers can be downloaded here:

Download EDD drivers (<http://www.siemens.com/flowdocumentation>)

Configuration of the HART polling address

The HART address can be set either via hardware (DIP switch) or via software (LUI or SIMATIC PDM).

The DIP switch is located on the transmitter cassette, see position ⑥ "Transmitter exploded view" in "Design" (Page 31).

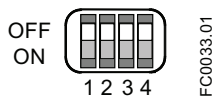

Figure 3-6 HART slave address switch

- Configuration via DIP switch (HW polling address)
Set "1 to 15" on the DIP switch if you wish to set a fixed (hardware-defined) HART polling address (SW polling address will be ignored). The configured HW polling address can be read via LUI in menu item 4.2.
- Configuration via LUI or SIMATIC PDM (SW polling address)
Disable the HW polling address by setting all switches to "OFF" on the HART DIP switch. The device starts up with default slave address = 0. The SW polling address can be changed to "0 to 63" via LUI (menu item 4.1) or SIMATIC PDM

DIP switch configuration

Table 3-2 HW polling address

Address	Switch 1	Switch 2	Switch 3	Switch 4
0	0	0	0	0
1	1	0	0	0
2	0	1	0	0
3	1	1	0	0
4	0	0	1	0
5	1	0	1	0
6	0	1	1	0
7	1	1	1	0
8	0	0	0	1
9	1	0	0	1
10	0	1	0	1
11	1	1	0	1
12	0	0	1	1
13	1	0	1	1
14	0	1	1	1
15	1	1	1	1

0: OFF; 1: ON

Mapping of measured process variables

The assignment of the measured process values to HART device variables (PV - primary variable; SV - secondary variable; TV - tertiary variable; and QV - quaternary variable) can be modified and assigned as desired via local user interface or via HART interface using SIMATIC PDM.

PV: The process value assigned to current output 1 (LUI menu item 2.4.1.1) is automatically assigned to PV.

- Measured values for PV
 - Mass flow
 - Volume flow
 - Density

SV, TV, QV: Freely selectable (LUI menu item 4.6) from the list below.

3.4 HART Communication Interface

- Measured values for SV, TV and QV
 - Massflow
 - Volumeflow
 - Density
 - Medium temperature
 - Volume flow corrected
 - Fraction A mass flow
 - Fraction A volume flow
 - Fraction B mass flow
 - Fraction B volume flow
 - Fraction A %
 - Fraction B %
 - Totalized value of totalizers 1, 2 or 3

Communication is via the HART protocol, using:

- HART Communicator (load 230 to 500 Ω)
- PC with HART modem, on which appropriate software is installed, for example SIMATIC PDM (load 230 to 500 Ω)
- Control system which can communicate via the HART protocol, for example SIMATIC PCS7

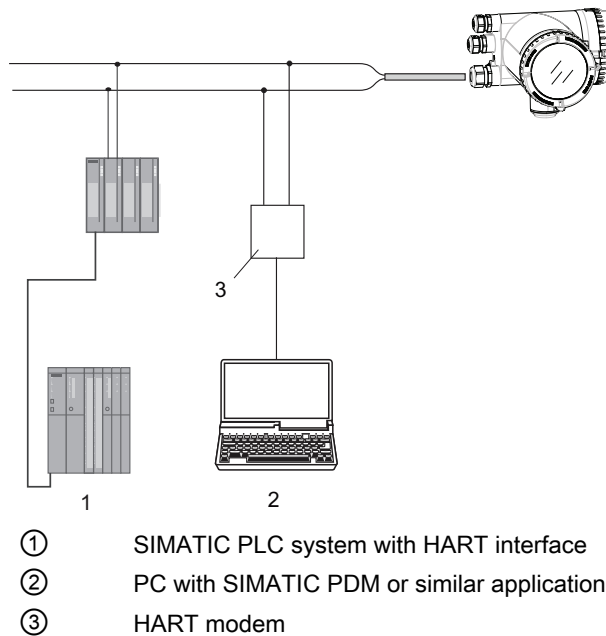

Figure 3-7 Possible system configurations

3.5 Theory of operation

The Coriolis principle of measurement

The flow measurement is based on the Coriolis law of motion. Particles moving in a rotating / oscillating system will resist imposed oscillations in a manner consistent with their mass and velocity (momentum). Oscillation produced by a Coriolis flowmeter where the process media is accelerated around bends results in phase distortions of the measuring tubes.

The SITRANS F C sensors are energized by an electromagnetic driver circuit which oscillates the pipes at their resonant frequency. Two pickups are placed symmetrically on either side of the driver to provide position signals for digital processing.

When the media flows through the sensor, Coriolis force will act on the measuring tubes and cause deflection which can be measured as a phase shift between Pickup 1 and Pickup 2. The phase shift is proportional to the mass flowrate.

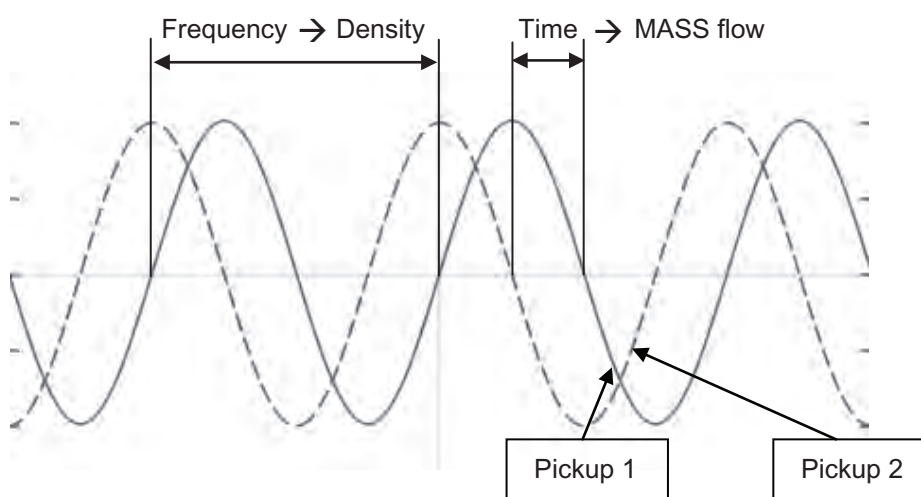

The frequency (or period) of the vibration is a direct function of the process media density.

The frequency and amplitude of the driver is regulated to ensure a stable output from the 2 pickups. The temperature of the sensor tubes is measured to provide accurate compensation for changes in the material stiffness. As a result the process media temperature is also accurately measured.

The flow proportional phase signal from the pickups, the temperature measurement and the driver frequency enable calculation and reporting of mass, density, volume, and temperature.

Digital signal processing (DSP)

The analog to digital conversion takes place in an ultra low noise sigma delta converter with high signal resolution. With fast digital signal processing massflow and density values are calculated using a patented DFT technology (Discrete Fourier Transformation). The combination of this patented DFT technology and the fast DSP enables short response time (< 10 ms) to changes in the measured values.

3.5 Theory of operation

The built-in noise filter is configurable and can be used for improving the performance of the flowmeter, in case the installation and application conditions are not ideal. Typical process noise such as gas bubbles (two-phase-flow) can be reduced through the filter functions.

Installing/mounting

4.1 Introduction

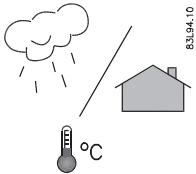

SITRANS F flowmeters with minimum IP67/NEMA 4X enclosure rating are suitable for indoor and outdoor installations.

- Make sure that specifications for process pressure (PS) and media temperature (TS) plus ambient temperature that are indicated on the device nameplate / label will not be exceeded.

WARNING

Installation in hazardous location

Special requirements apply to the location and interconnection of sensor and transmitter. See "Installation in hazardous locations" (Page 20)

4.2 Strong vibrations

CAUTION

Strong vibrations

Damage to device.

- In plants with strong vibrations, mount the transmitter in a low vibration environment away from the sensor.

4.3 Sensor installation

4.3.1 Installation safety precautions

WARNING

High pressure hazard

In applications with working pressures/media that can be dangerous to people, surroundings, equipment or others in case of pipe fracture, we recommend that special precautions such as special placement, shielding or installation of a pressure guard or a safety valve are taken when the sensor is mounted.

 WARNING
Exceeded maximum permissible operating pressure
Danger of injury or poisoning.
The maximum permissible operating pressure depends on the device version. The device can be damaged if the operating pressure is exceeded. Hot, toxic and corrosive process media could be released.
<ul style="list-style-type: none">• Make sure that the device is suitable for the maximum permissible operating pressure of your system. Refer to the information on the nameplate and/or in "Rated operating conditions (Page 178)".

 CAUTION
Hot surfaces resulting from hot process media
Danger of burns resulting from surface temperatures above 70 °C (155 °F).
<ul style="list-style-type: none">• Take appropriate protective measures, for example contact protection.• Make sure that protective measures do not cause the maximum permissible ambient temperature to be exceeded. Refer to the information in Chapter "Rated operating conditions (Page 178)".

 CAUTION
External stresses and loads
Damage to device by severe external stresses and loads (e.g. thermal expansion or pipe tension). Process media can be released.
<ul style="list-style-type: none">• Prevent severe external stresses and loads from acting on the device.

 WARNING
Wetted parts unsuitable for the process media
Danger of injury or damage to device.
Hot, toxic and corrosive media could be released if the process medium is unsuitable for the wetted parts.
<ul style="list-style-type: none">• Ensure that the material of the device parts wetted by the process medium is suitable for the medium. Refer to the information in "Technical data" (Page 180).

Note

Material compatibility

Siemens can provide you with support concerning selection of sensor components wetted by process media. However, you are responsible for the selection of components. Siemens accepts no liability for faults or failures resulting from incompatible materials.

4.3.2 Determining a location

 CAUTION
--

Do not install the sensor in the vicinity of strong electromagnetic fields, for example near motors, variable frequency drives, transformers etc.

Upstream / downstream

- No pipe run requirements, that is straight inlet/outlet sections are not necessary.
- Avoid long drop lines downstream from the sensor to prevent process media separation causing air / vapour bubbles in the tube (min. back pressure: 0.2 Bar).
- Avoid installing the sensor immediately upstream of a free discharge in a drop line.

Location in the system

The optimum location in the system depends on the application:

- Liquid applications
Gas or vapor bubbles in the fluid may result in erroneous measurements, particularly in the density measurement.
 - Do not install the flowmeter at the highest point in the system, where bubbles will be trapped.
 - Install the flowmeter in low pipeline sections, at the bottom of a U-section in the pipeline.

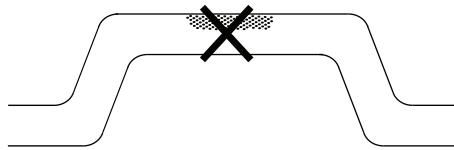

Figure 4-1 Liquid applications, wrong location with trapped air/gas

- Gas applications
Vapor condensation or oil traces in the gas may result in erroneous measurements.
 - Do not install the flowmeter at the lowest point of the system
 - Install a filter.

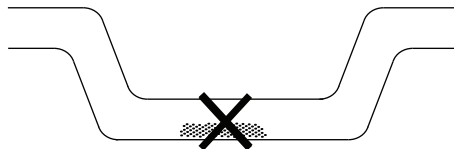



Figure 4-2 Gas applications, wrong location with trapped oil

4.3.3 Orientation of the sensor

Flow direction

The calibrated flow direction is indicated by the arrow on the sensor. Flow in this direction will be indicated as positive by default. The sensitivity and accuracy of the sensor is identical with reverse flow.

The indicated flow direction (positive/ negative) is configurable.

 CAUTION
The sensor must always be completely filled with process media in order to measure accurately.

Orienting the sensor

SITRANS FCS400 operates in any orientation, but Siemens recommends orienting the sensor in one of the following ways:

1. Vertical installation with an upwards flow (self-draining)

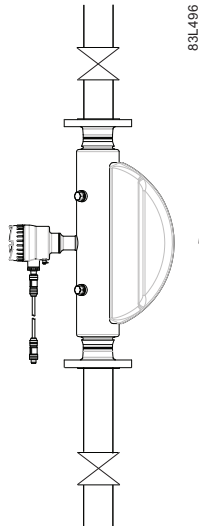

Figure 4-3 Vertical orientation, upwards flow

2. Horizontal installation, tubes down (only recommended for liquid applications)

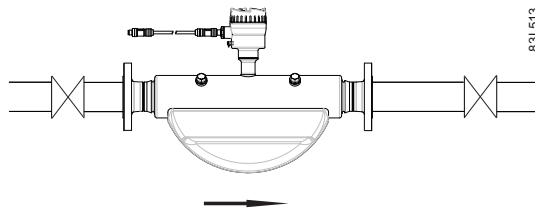

Figure 4-4 Horizontal orientation, tubes down

3. Horizontal installation, tubes up (only recommended for gas applications)

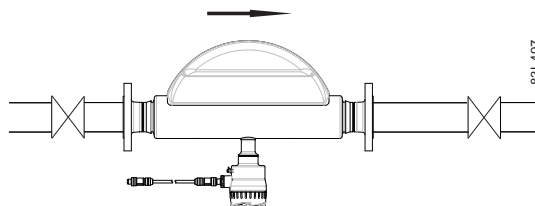

Figure 4-5 Horizontal orientation; tubes up

Note

Hygienic applications

In 3A and EHEDG certified hygienic applications the flowmeter must be installed vertically as shown in 1.

Installation in a drop line

Installation in a drop line is only recommended if a pipeline reduction or orifice with a smaller cross-section can be installed to create back-pressure and prevent the sensor from being partially drained while measuring.

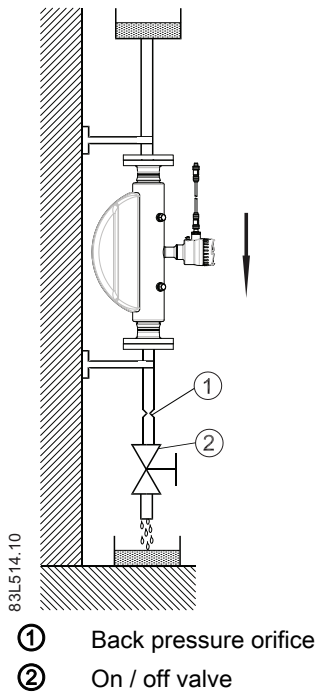

Figure 4-6 Installation in drop line

4.3.4 Mounting the sensor

NOTICE

Incorrect mounting

The device can be damaged, destroyed, or its functionality impaired through improper mounting.

- Before installing ensure there is no visible damage to the device.
- Make sure that process connectors are clean, and suitable gaskets and glands are used.
- Mount the device using suitable tools. Refer to the information in "Technical data" (Page 185) , for example installation torques requirements.

<p>⚠ WARNING</p> <p>Unsuitable connecting parts</p> <p>Danger of injury or poisoning.</p> <p>In case of improper mounting hot, toxic and corrosive process media could be released at the connections.</p> <ul style="list-style-type: none">• Ensure that connecting parts (such as flange gaskets and bolts) are suitable for connection and process media.

- Install the sensor in rigid pipelines in order to support the weight of the meter.
- Center the connecting pipelines axially in order to assure a stress-free installation.
- Install two supports or hangers symmetrically and stress-free on the pipeline in close proximity to the process connections.

Handling

Note

Compact versions

Never lift the flowmeter using the transmitter housing, that is always lift the sensor body.

Avoid vibrations

- Make sure that any valves or pumps upstream of the sensor do not cavitate and do not send vibration into the sensor.
- Decouple vibrating pipeline from the flow sensor using flexible tube or couplings

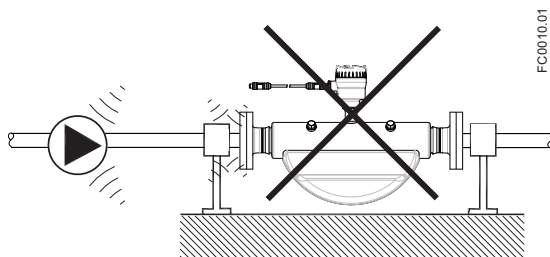

Figure 4-7 Non-flexible pipes not recommended in vibrating environment

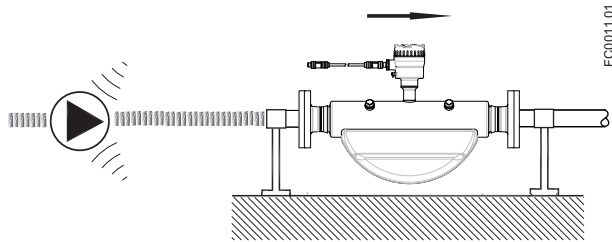

Figure 4-8 Flexible pipes recommended in vibrating environment

Avoid cross talk

If operating more than one flowmeter in one or multiple interconnected pipelines there is a risk of cross talk.

Prevent cross talk in one of the following ways:

- Mount sensors on separate frames
- Decouple the pipeline using flexible tube or couplings

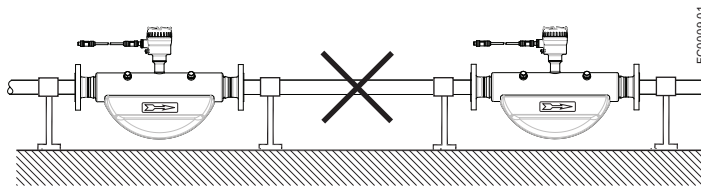

Figure 4-9 High risk of cross talk when using non-flexible pipes

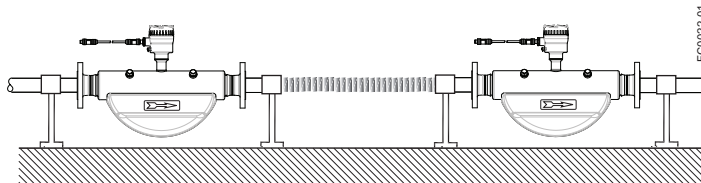

Figure 4-10 Low risk of cross talk when using flexible pipes

4.3.5 Mounting a pressure guard

The sensor enclosure is supplied with two G $\frac{1}{2}$ " purge ports. These ports can for example be used for a pressure guard, which can be connected to an automatic shut off valve to stop the flow in case of sensor pipe fracture. The pressure guard can only be applied in non-hazardous locations. Opening either of the purge ports will void any Ex rating for the sensor.

The AISI 304 / EN 1.4301 exterior enclosure is rated to approximately 20 bar static pressure to contain spilt process media in the event of a tube break. However it is not intended to contain high pressure or corrosive fluids and precautions must be taken in applications where vibrating tube failure is probable and may cause damage.

Pressure guard selection

Siemens does not supply the components of the pressure guard solution because the arrangement and components are closely related to individual safety and protection practices in each place.

The selection of pressure guard solution is the responsibility of the user, however Siemens recommends the following forms of pressure guard:

- A pressure switch screwed directly or piped into one of the purge ports and connected to an automatic shutoff valve will disable pressurized supply to the meter.
- A relief valve or bursting disc screwed directly or piped to one of the purge ports to carry any spilt fluid to drain.

The pressure switch and relief valve set point should be 2-3 bar gauge. The pressure switch should be rated to withstand the full process pressure and temperature for a short time without rupture.

 CAUTION
Drain flow Ensure the drain flow is safely contained away from personnel and other plant or equipment.

Mounting of pressure guard

 CAUTION
Moisture, liquids or particles getting into the sensor enclosure All sensors are filled with argon to avoid condensation. Ingress of moisture, liquids or particles into the sensor may influence the measurement and in worst case inhibit the measuring function. <ul style="list-style-type: none">• Avoid moisture, liquids or particles getting into the sensor enclosure

Install a pressure guard as follows:

1. Place the sensor in a dry, clean place and leave it to acclimatize until it reaches ambient temperature, preferred 20°C (68°F) with low humidity (at least below 50% RH).
2. Orient the sensor with the purge ports uppermost to minimize loss of the Argon gas filling.
3. Carefully remove the plug and mount the pressure guard.
Use replacement soft metal sealing rings for proper sealing

 CAUTION
Lack of proper sealing Soft metal sealing rings only maintain a hermetic seal within the enclosure with single use. <ul style="list-style-type: none">• Ensure that soft metal sealing rings are not reused.

4.4 Transmitter installation

4. Make sure that the pressure guard does NOT touch any of the parts inside the sensor. Maximum of 20 mm (0.79") insertion can be accommodated.
5. Check that the pressure guard has been correctly mounted and thoroughly tightened (torque: 80 Nm).

 WARNING
Operation in proximity with pressure guards Prevent personal injuries by assuring that operation in close proximity with pressure guards cannot take place.

4.4 Transmitter installation

4.4.1 Introduction

This chapter describes how to install the transmitter on a wall or pipe (remote configurations only). The chapter further describes how to turn the transmitter or the local display in order to optimize the viewing angle.

The following installation steps must be carried out:

1. Install the mounting bracket (Page 49) on a wall or pipe.
2. Install the transmitter on the mounting bracket (Page 50).
3. Turn the transmitter (Page 50) and/or turn the local display (Page 52) (optional).

 CAUTION
Aggressive atmospheres Damage to device through penetration of aggressive vapors. <ul style="list-style-type: none">• Ensure that the device is suitable for the application.

 CAUTION
Direct sunlight Device damage. The device can overheat or materials become brittle due to UV exposure. <ul style="list-style-type: none">• Protect the device from direct sunlight.• Make sure that the maximum permissible ambient temperature is not exceeded. Refer to the information in "Technical data" (Page 178).

4.4.2 Wall mounting

1. Prepare holes with aid of mounting bracket, see "Mounting bracket" (Page 202).
2. Fasten mounting bracket with black cushion pad to wall (torque 10 Nm).

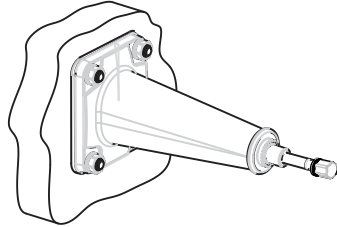

4.4.3 Pipe mounting

1. Mount mounting bracket with cushion pad on pipe using fastening brackets/U-bolts and supplied pipe adaptor. Note: U-bolts and other miscellaneous hardware are not supplied with the flowmeter.
2. Tighten nuts (torque: 10 Nm).

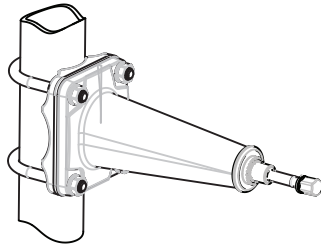

Note

Hygienic applications

If the device is wall or pipe-mounted in a hygienic application, **always** use domed nuts.

4.4 Transmitter installation

4.4.4 Mounting the transmitter

1. Remove screw from mounting bracket.
2. Mount transmitter on mounting bracket taking care that the flutes on the mating faces are correctly engaged.

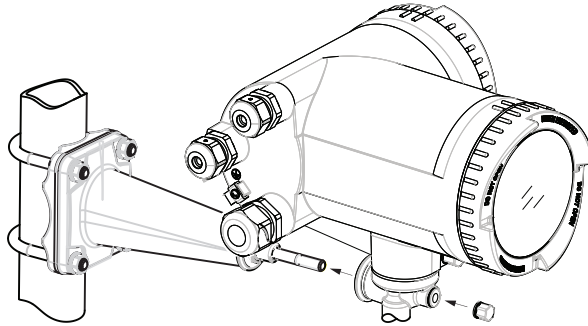

3. Firmly tighten screw on mounting bracket (torque: 25 Nm).

4.4.5 Turning the transmitter

In a remote configuration, the transmitter can be turned horizontally and vertically. In a compact configuration, the transmitter can be turned horizontally only.

Horizontal rotation

1. Unscrew cap from lock screw.
2. Loosen lock screw at transmitter pedestal using 5 mm Allen key.

3. Carefully rotate transmitter into desired position.

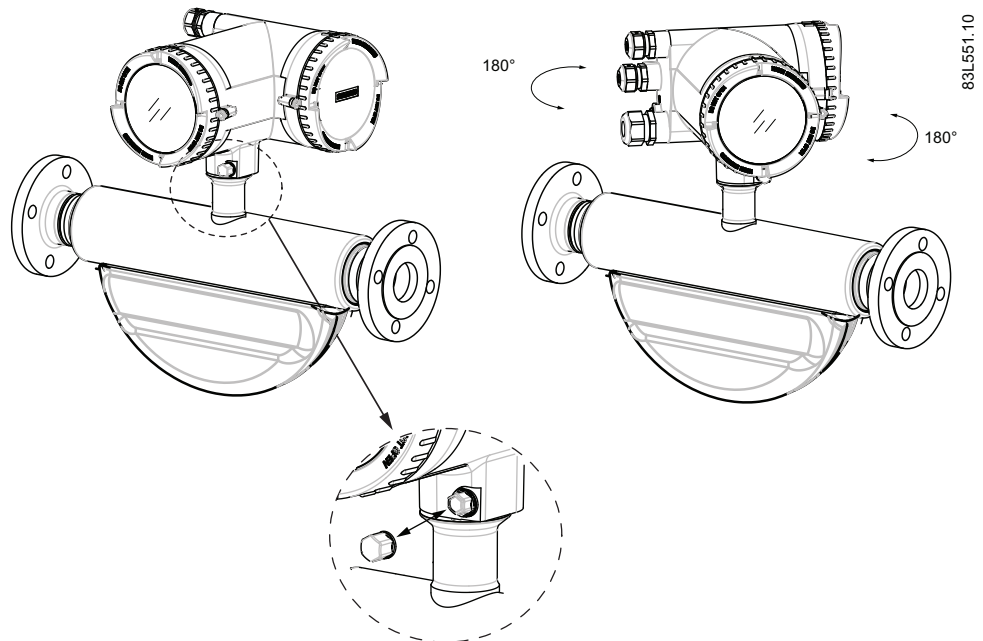

4. Firmly tighten lock screw (torque: 10 Nm).
5. Replace cap onto lock screw (torque: 10 Nm).

Vertical rotation

1. Loosen locking cap at end of mounting bracket by three turns.
2. Carefully loosen and rotate transmitter into desired position (15° steps).

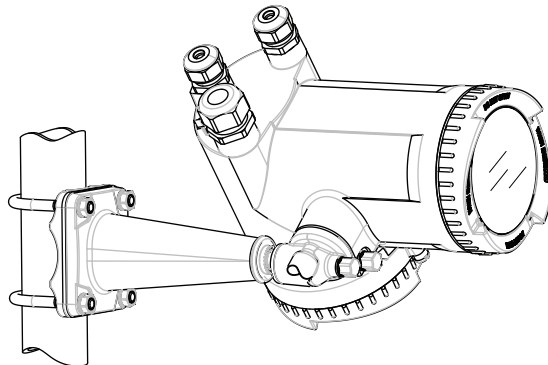

3. Firmly tighten locking cap (torque: 25 Nm).

4.4.6 Turning the local display

The local display can be turned in steps of 30° in order to optimize the viewing angle.

1. Remove lid lock screw of display cover.
2. Remove display cover.
3. Carefully pull out local display.
4. Turn display into desired position.

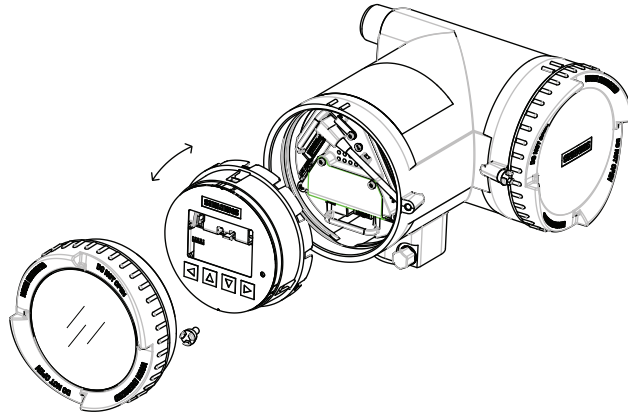

5. Carefully push display back into housing.

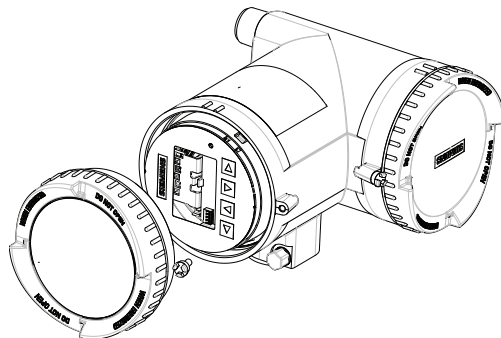

6. Remove o-ring from lid.
7. Reinstall display cover until mechanical stop. Wind back lid by one turn.
8. Mount o-ring by pulling it over the display cover and turn display cover until you feel friction from the o-ring on both sides. Wind display cover by one quarter of a turn to seal on the o-ring.
9. Reinstall and tighten lid lock screw.

Connecting

This chapter describes how to wire up the device.

The following steps must be carried out:

- Step 1: Connecting the sensor and the transmitter (only remote versions) (Page 56)
- Step 2: Preparing for the transmitter connections (Page 59)
- Step 3: Connecting the power supply (Page 63)
- Step 4: Connecting the I/Os (Page 65)
- Step 5: Finishing the transmitter connection (Page 69)

5.1 General safety requirements

 WARNING
The pertinent regulations must be observed for electrical installation. <ul style="list-style-type: none">• Never install the device with the mains voltage switched on!• Danger of electric shock!• If the housing is under voltage (power supply), the cover may be unscrewed by qualified personnel only, except in classified hazardous locations.

 WARNING
Mains supply from building installation overvoltage category 2 <p>A switch or circuit breaker (max. 15 A) must be installed in close proximity to the equipment and within easy reach of the operator. It must be marked as the disconnecting device for the equipment.</p>

 WARNING
Wire insulation <p>Required cable: minimum AWG16 or 1.5 mm² Cu wire.</p> <p>The insulation between the connected mains supply and 24 V AC/DC supply for the flowmeter must at least be rated with double or reinforced insulation at mains voltage.</p>

5.2 Wiring in hazardous locations

Hazardous area applications

Special requirements apply to the location and interconnection of sensor and transmitter. See "Installation in hazardous locations" (Page 20).

 WARNING
Terminal box Before opening the terminal box check that: <ul style="list-style-type: none">• No explosion hazard exists• All connection leads are potential free

 WARNING
Grounding The mains protective earth wire must be connected to the PE terminal.

Note

Output cables

If long cables are used in noisy environments, it is recommended to use screened cables.

5.3 Cable requirements

Cable specifications

- Only use cables with at least the same degree of protection as the sensor to install the sensor. It is recommended to use cables supplied by Siemens A/S, Flow Instruments:
 - blue cables for installation in hazardous areas
 - gray cables for installation in non-hazardous areasFurther information on Siemens-supplied cables, see "Technical Data" (Page 183).
- The wire length inside the terminal box, from the cable gland to the terminals, must be kept as short as possible. Wire loops in the terminal box must be avoided.
- To guarantee the IP67 degree of protection, ensure that both ends of the cables are given equivalent protection from ingress of moisture.

 WARNING
Cable requirements
Cables must be suitable for the temperature (at least 70 °C) and be flammability-rated to at least V-2.

 WARNING
Unprotected cable ends
Danger of explosion through unprotected cable ends in hazardous areas.
<ul style="list-style-type: none"> • Protect unused cable ends in accordance with IEC/EN 60079-14.

5.4 Safety notes for connecting

 WARNING
Skills
Only qualified personnel may carry out work on the electrical connections.

Use in hazardous locations

Before accessing the sensor terminal space and application terminal space check that:

- No explosion hazard exists
- A safe access permission certificate has been issued by plant operations management
- All connection leads are potential free

 WARNING
Hazardous locations
Observe the type examination certificates or the test certifications applicable in your country if you use transmitters as category 1/2 equipment.

 WARNING
Commissioning
Only commission the device after the device has been properly connected and, if required, closed.

5.5 Step 1: Connecting the sensor and the transmitter

The following only applies to remote configurations.

Wiring sensor and transmitter (M12)

The sensor is provided with a preformed cable terminated with M12 style stainless steel weather-proof plugs.

The cable screen is physically and electrically terminated within the body of the plug.

Take care when handling the cable and passing it through cable ducting that the plug is not subjected to excessive tension (pulling) as the internal connections may be disengaged.

Note

Never pull the cable by the plug - only by the cable itself.

1. Connect sensor using the supplied 4-wire cable with M12 connectors.

Note

Grounding

The sensor cable screen is mechanically connected to the grounding terminal (PE), only when the M12 plug is correctly tightened.

Wiring sensor and transmitter (sensor terminal spaces)

A: Prepare the cable by stripping it at both ends.

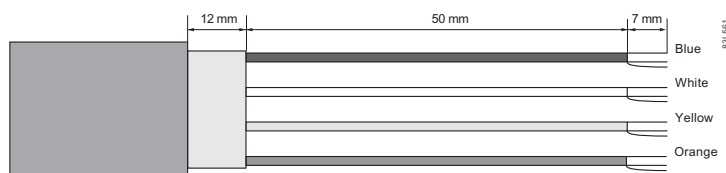

Figure 5-1 Cable end

B: Connecting within the sensor terminal spaces

1. Remove lock screw and remove lid.
2. Remove one of the blind plugs and fit cable gland.
3. Remove cap and ferrule from cable gland and slide onto cable.
4. Push cable through open gland; anchor cable screen and wires with clamp bar.
5. Connect wires to terminals according to list below.

Terminal number	Description	Wire color (Siemens)
1	+15 V DC	Orange
2	0 V DC	Yellow

5.5 Step 1: Connecting the sensor and the transmitter

Terminal number	Description	Wire color (Siemens)
3	B	White
4	A	Blue



1. Assemble and tighten cable gland.
2. Remove o-ring from lid.
3. Reinstall lid and screw in until mechanical stop. Wind back lid by one turn.
4. Mount o-ring by pulling it over the lid and tighten lid until you feel friction from the o-ring on both sides. Wind lid by one quarter of a turn to seal on the o-ring.
5. Reinstall and tighten lid lock screw

Connecting sensor DSL

1. Remove lock screw and remove DSL lid.
2. Undo the flexible strap.
3. Disconnect sensor connection from DSL cassette.
4. Loosen mounting screw using a TX10 Torx driver and remove DSL cassette from housing.
5. Remove cap and ferrule from cable gland and slide onto cable.
6. Push cable through open gland; anchor cable screen and wires with clamp bar.
7. Remove terminal block from DSL cassette.
8. Connect wires to terminals according to list below.

Terminal number	Description	Wire color (Siemens cable)
1	+15 V DC	Orange
2	0 V DC	Yellow
3	B	White
4	A	Blue

5.5 Step 1: Connecting the sensor and the transmitter



1. Reinstall DSL cassette including mounting screw.
2. Connect sensor connection and sensor cable.
3. Restore flexible strap around all wires.



4. Assemble and tighten cable gland.
5. Remove o-ring from DSL lid.
6. Reinstall lid and screw in until mechanical stop. Wind back lid by one turn.
7. Mount o-ring by pulling it over the DSL lid and tighten lid until you feel friction from the o-ring on both sides. Wind lid by one quarter of a turn to seal on the o-ring.
8. Reinstall and tighten lid lock screw.

⚠ WARNING

Improper laying of shielded cables

Danger of explosion through compensating currents between hazardous area and the non-hazardous area.

- Only ground shielded cables that run into the hazardous area at one end.
- If grounding is required at both ends, use an equipotential bonding conductor

 WARNING
Insufficient isolation of non-intrinsically safe and intrinsically safe circuits
Danger of explosion in areas subject to explosion hazard.
<ul style="list-style-type: none">• When connecting intrinsically safe and non-intrinsically safe circuits ensure that isolation is carried out properly in accordance with IEC / EN 60079-14.• Make sure that you observe the test certification applicable in your country.

5.6 Lack of equipotential bonding

 WARNING
Lack of equipotential bonding
Danger of explosion through compensating currents or ignition currents through lack of equipotential bonding.
<ul style="list-style-type: none">• Ensure that the device is potentially equalized.

5.7 Step 2: Preparing for the transmitter connections

 WARNING
Non-hazardous locations only
As long as the device is energized, the lid of the housing on the sensor connection area may only be opened by qualified personnel.
Before removing the terminal cover, the auxiliary power must be switched off from all poles.
Following installation, the terminal cover must be screwed back on again.

5.7 Step 2: Preparing for the transmitter connections

1. Remove blind plugs where required and mount cable glands.

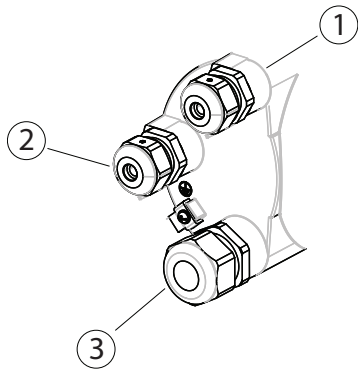

- ① Input/output connection (channels 2 to 4)
- ② Power supply connection
- ③ Current output/HART connection (channel 1)

2. Remove lid lock screw for terminal connections lid.
3. Remove lid for terminal connections.

A label with a diagram showing the terminal connections is placed at the back of the terminal connections lid.

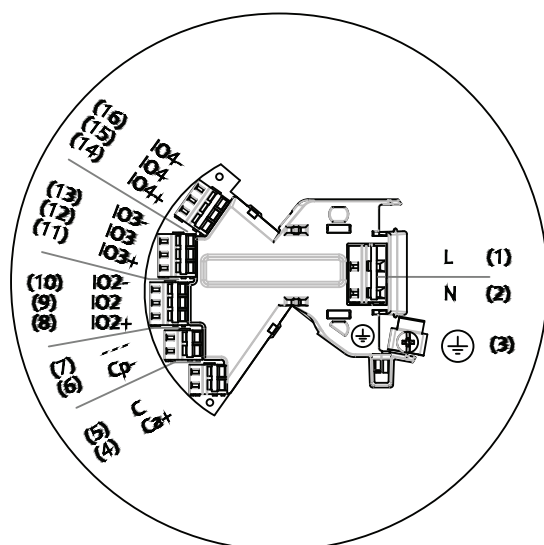

FC0032.01.02

- | | | |
|---|------|---|
| ① | L/+ | Line |
| ② | N/- | Neutral |
| ③ | ⊕ | Ground |
| ④ | Ca+ | Used in current output active configuration |
| ⑤ | C | Used in current output active and passive configuration |
| ⑥ | Cp- | Used in current output passive configuration |
| ⑦ | --- | Not used |
| ⑧ | IO2+ | Signal output channel 2 positive |
| ⑨ | IO2 | Signal output channel 2 common |
| ⑩ | IO2- | Signal output channel 2 negative |
| ⑪ | IO3+ | Input/output channel 3 positive |
| ⑫ | IO3 | Input/output channel 3 common |
| ⑬ | IO3- | Input/output channel 3 negative |
| ⑭ | IO4+ | Input/output channel 4 positive |
| ⑮ | IO4 | Input/output channel 4 common |
| ⑯ | IO4- | Input/output channel 4 negative |

For configuration of the inputs/outputs, see table in section "Step 4b: Connecting the inputs and outputs (channels 2 to 4)" (Page 66).

 WARNING
Unsuitable cables and/or cable glands
Danger of explosion in hazardous areas.
<ul style="list-style-type: none">• Only use suitable cables and cable glands complying with the requirements specified in "Technical data" (Page 183).• Tighten the cable glands in accordance with the torques specified in "Technical data" (Page 185).• When replacing cable glands use only cable glands of the same type.• After installation check that the cables are seated firmly.

 WARNING
Open cable inlet or incorrect cable gland
Danger of explosion in hazardous areas.
<ul style="list-style-type: none">• Close the cable inlets for the electrical connections. Only use cable glands or plugs which are approved for the relevant type of protection.

See also

Cables and cable entries (Page 183)

 WARNING
Incorrect conduit system
Danger of explosion in hazardous areas as result of open cable inlet or incorrect conduit system.
<ul style="list-style-type: none">• In the case of a conduit system, mount a spark barrier at a defined distance from the device input. Observe national regulations and the requirements stated in the relevant approvals.

Wiring tool

Use the wiring tool for connecting the cables.

The wiring tool is located in the application terminal space.

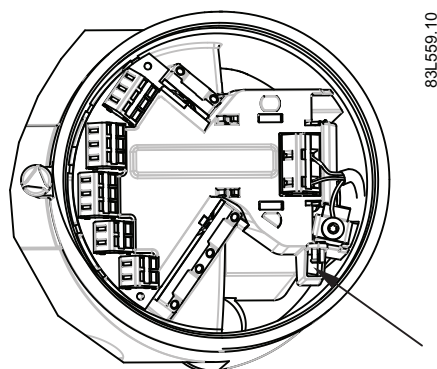
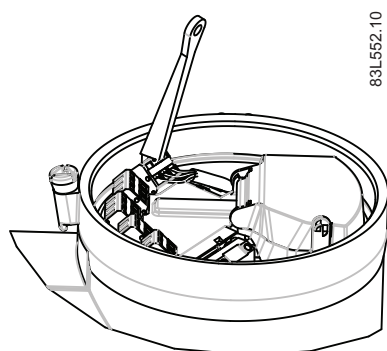

Figure 5-2 Wiring tool location



1. Insert wiring tool hook into receptor slot.
2. Press wiring tool wedge into top slot to spread clamp plates.
3. Insert wire.
4. Release wiring tool.

5.8 Step 3: Connecting the power supply

1. Flip open power supply terminal protection cover.
2. Remove cap and ferrule from cable gland and slide onto cable.

5.8 Step 3: Connecting the power supply

3. Push cable through open gland and cable path.

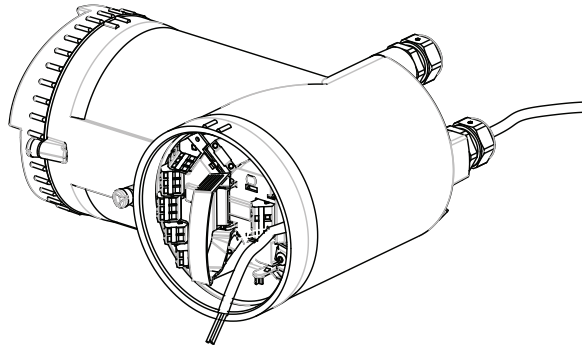

4. Restore ferrule and tighten cap to lightly hold cable in place.

5. Connect ground to terminal \ominus and power to terminals L/+ and N/- using wiring tool in the manner shown below at right.

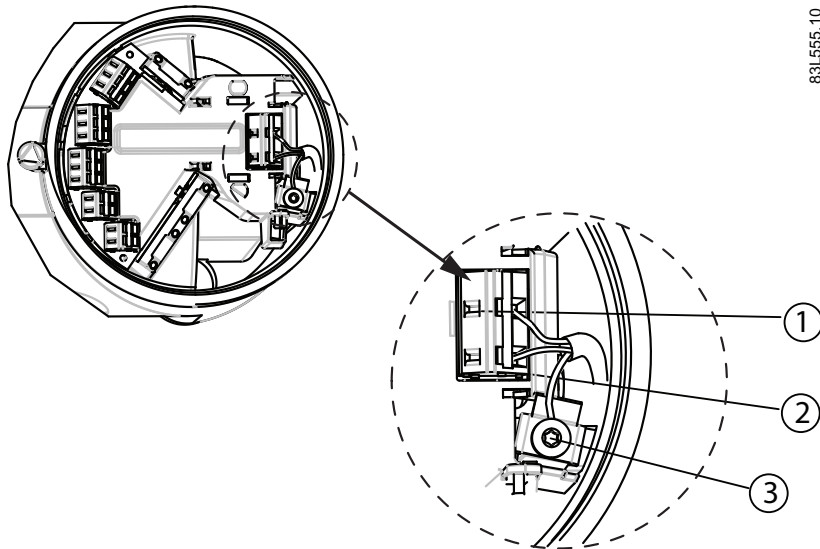

83L555.10

①	L/+
②	N/-
③	\ominus

AC connection	DC connection
<p style="text-align: center;">83L553.10</p>	<p style="text-align: center;">83L554.10</p>
<p>Power: 100 to 240 V AC +10/-15%, 47 to 63 Hz</p>	<p>Power: 24 to 90 V DC +20/-20%</p>

1. Anchor cable with clamp bar.
2. Close and latch power supply terminal protection cover.
3. Tighten cable gland.

5.9 Missing PE/ground connection

 WARNING
Missing PE/ground connection Danger of electric shock. Depending on the device version, connect the power supply as follows: <ul style="list-style-type: none">• Connecting terminals: Connect the terminals according to the terminal connection diagram. First connect the PE/ground conductor.

5.10 Step 4a: Connecting the current output HART (channel 1)

Note

HART communication

It is recommended to use shielded cables for HART communication.

 WARNING
Passive channels only Channel 1 power supply must be separated from that for channels 2 to 4. Signal return (or common) can be joined.

1. Remove cap and ferrule from cable gland and slide onto cable.
2. Push cable through open gland and cable path.
3. Restore ferrule and tighten cap to lightly hold cable in place.
4. Signal cable screen is folded back over outer sheath and grounded beneath cable clamp.

5.11 Step 4b: Connecting the inputs and outputs (channels 2 to 4)

5. Connect wires to terminals using wiring tool.

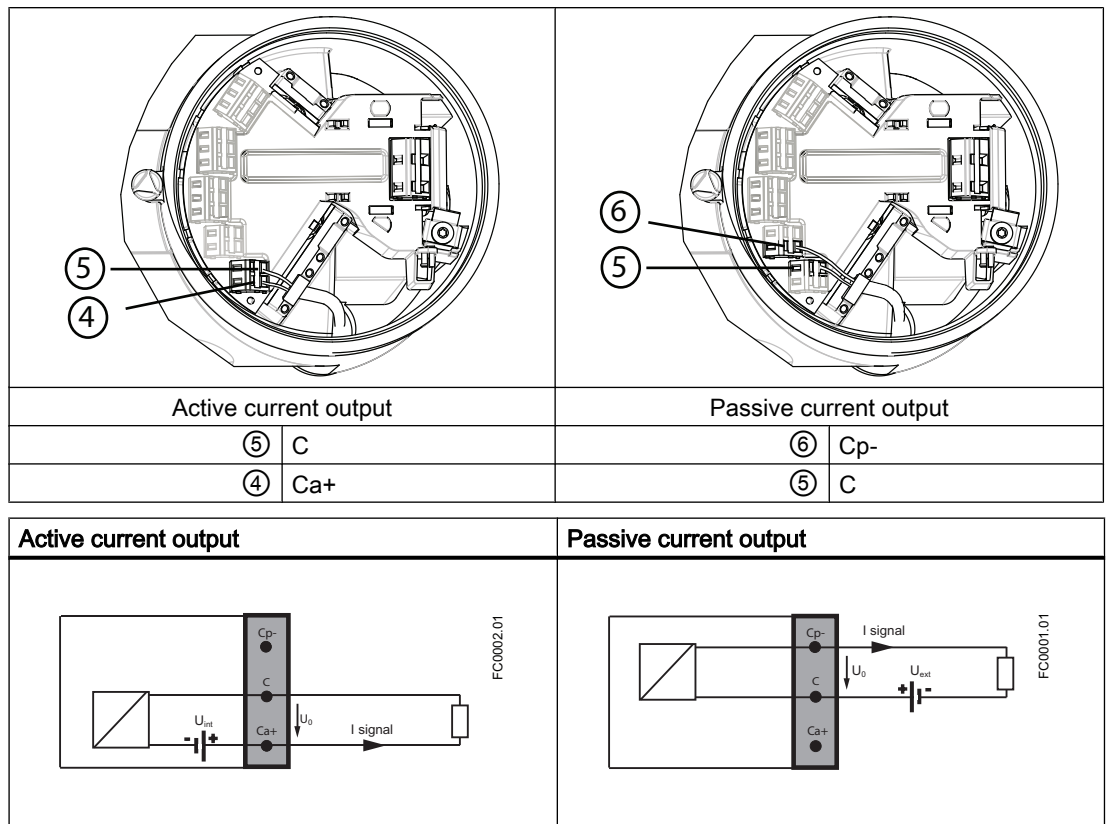

6. Tighten cable gland.

Note

Active or passive current output is preselected at ordering.

Note

Load

Current output (channel 1): < 500 Ω (HART ≥ 230 Ω)

5.11 Step 4b: Connecting the inputs and outputs (channels 2 to 4)

1. Remove cap and ferrule from cable gland and slide onto cable.
2. Push cable through open gland and cable path.
3. Restore ferrule and tighten cap to lightly hold cable in place.
4. Signal cable screen is folded back over outer sheath and grounded beneath cable clamp.

5.11 Step 4b: Connecting the inputs and outputs (channels 2 to 4)

5. Connect wires to terminals using wiring tool.

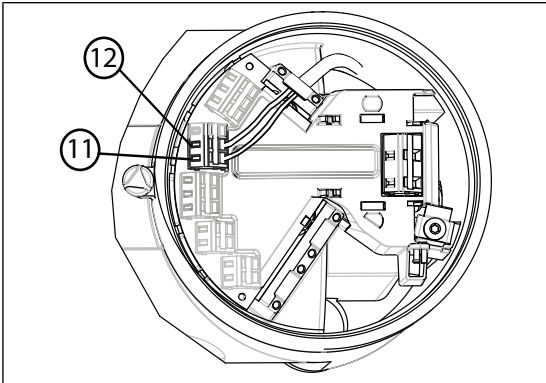
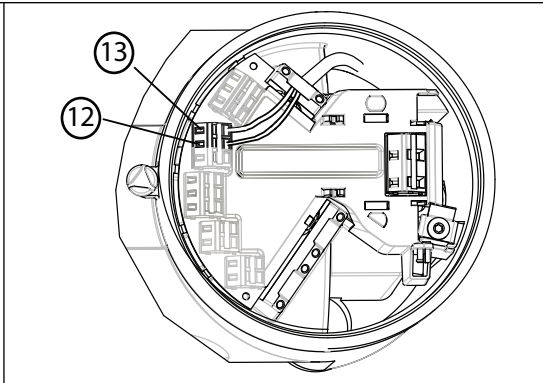
	
Active current output	Passive current output
⑫ IO[3] (common)	⑬ IO[3]- (passive)
⑪ IO[3]+ (active)	⑫ IO[3] (common)
Termination example for channel 3	

6. Tighten cable gland.

Note

Active or passive current output is preselected at ordering.

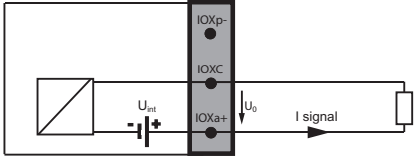
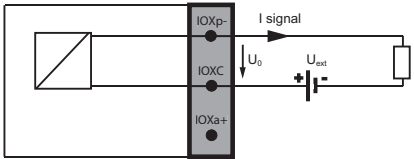
Factory configuration	Software configuration	Channel 2	Channel 3	Channel 4	
Signal output Active	Current Output Pulse Output Frequency Output Status Output If Status Output: Alarm Class Alarm Item Primary Valve Dosing Secondary Valve Dosing	X	X	X	 <p style="text-align: right;">FC0003.01</p>
Signal output Passive	Current Output Pulse Output Frequency Output Status Output If Status Output: Alarm Class Alarm Item One Stage Dosing Two Stage Dosing	X	X	X	 <p style="text-align: right;">FC0004.01</p>

Connecting

5.11 Step 4b: Connecting the inputs and outputs (channels 2 to 4)

Factory configuration	Software configuration	Channel 2	Channel 3	Channel 4	
Signal input Active	Start Dosing Stop Dosing Reset Totalizer 1 Reset Totalizer 2 Reset Totalizer 3 Reset All Totalizers Pause/Resume dosing, Force Output Freeze Output		X	X	
Signal input Passive	Start Dosing Stop Dosing Reset Totalizer 1 Reset Totalizer 2 Reset Totalizer 3 Reset All Totalizers Pause/Resume dosing, Force Output Freeze Output		X	X	
Relay output	Alarm Class Alarm Item One Stage Dosing Two Stage Dosing		X	X	<p>Normally open</p>
Relay output	Alarm Class Alarm Item One Stage Dosing Two Stage Dosing		X	X	<p>Normally closed</p>

Note

Load

Signal output: < 500 Ω

Relay output: 30 V AC/DC, 100 mA

5.12 Step 5: Finishing the transmitter connection

Connection check-up

1. Check individual wire installation by tugging firmly.
2. Firmly tighten cable glands and insert blanking plugs in unused cable entries.
3. Remove o-ring from lid.
4. Reinstall lid and screw in until mechanical stop. Wind back lid by one turn.
5. Mount o-ring by pulling it over the lid and tighten lid cover until you feel friction from the o-ring on both sides. Wind lid by one quarter of a turn to seal on the o-ring.
6. Reinstall and tighten lid lock screw where supplied.
7. Ensure that moisture does not penetrate to inside of electronics housing by creating a drip loop (bend cables downward) immediately before cable glands.

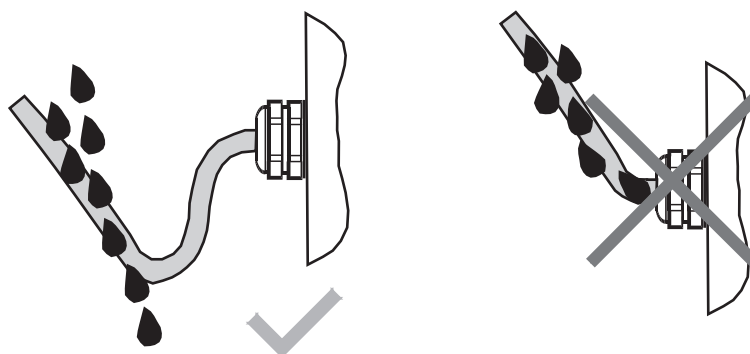

Note

Loss of degree of protection

Damage to device if the enclosure is open or not properly closed. The degree of protection specified on the nameplate or in "Technical data" (Page 180) is no longer guaranteed.

- Make sure that the device is securely closed.
-

Commissioning

6.1 General requirements

Before commissioning it must be checked that:

- The device has been installed and connected in accordance with the guidelines provided in "Installing/mounting" (Page 39) and "Connecting" (Page 53).
- Device installed in hazardous area meets the requirements described in "Installation in hazardous locations" (Page 20).

6.2 Warnings

 CAUTION
If the sensor and the transmitter are ordered separately, a "Set To Default" routine must be performed. This can be done via SIMATIC PDM or via LUI in menu item 3.3.3.

 WARNING
Certain parts inside the device carry dangerous high voltage. The housing must be closed and grounded before switching the device on.

 WARNING
The sensor connected to this device can be operated with high pressure and corrosive media. Therefore improper handling of the device can lead to serious injuries and/or considerable material damage.

 WARNING
Commissioning and operation with pending error
If an error message appears, correct operation in the process is no longer guaranteed.
<ul style="list-style-type: none"> • Check the gravity of the error • Correct the error • If the device is faulty: <ul style="list-style-type: none"> – Take the device out of operation. – Prevent renewed commissioning.

6.3 Commissioning via LUI

6.3.1 Introduction

In this chapter it is described how to commission the device via the local user interface (LUI) using the Quick Start menu.

For further information on how to operate the device via LUI, refer to "Operating; Local User Interface (LUI)" (Page 93).

Recommendation

Before commissioning a basic knowledge of the local display and the menu structure should be obtained. This is offered in the chapters

- "Local user interface (LUI)" (Page 93)
- "Navigating the menu" (Page 94)

Quick Start menu

The LUI includes a Quick Start menu with the most important parameters/menus for quick configuration of the flowmeter.

6.3.2 Overview

Quick start steps

The quick start menu prompts for check or setup of the following parameters/menus:

- Flow Direction
- Process Noise Damping
- Massflow
- Volumeflow
- Density
- Fluid Temperature
- Fraction
- Totalizer 1
- Totalizer 2

- Totalizer 3
- Start Zero Point Adjustment

Note**Preconditions for zero point adjustment**

Before a zero point adjustment is initiated, the pipe must be flushed, filled and at an absolute flowrate of zero. Refer to "Zero point adjustment" (Page 74) for more details.

6.3.3 Quick Start

The following example describes a configuration in which the Process Noise Damping, the Massflow and the Totalizer 1 settings are changed, and a Zero Point Adjustment is started.

Access Level

The access level is "User" (default PIN is 2457).

Process Noise Damping

The process noise damping is changed from "Duplex Pump" to "Triplex Pump".

Massflow

The unit is changed kg/s to kg/h; and the low flow cut-off is changed from 0 kg/h to 2 kg/h.

Totalizer 1

The direction is changed from positive to balanced.

Zero Point Adjustment

The zero point adjustment is started with default zero point adjustment settings.

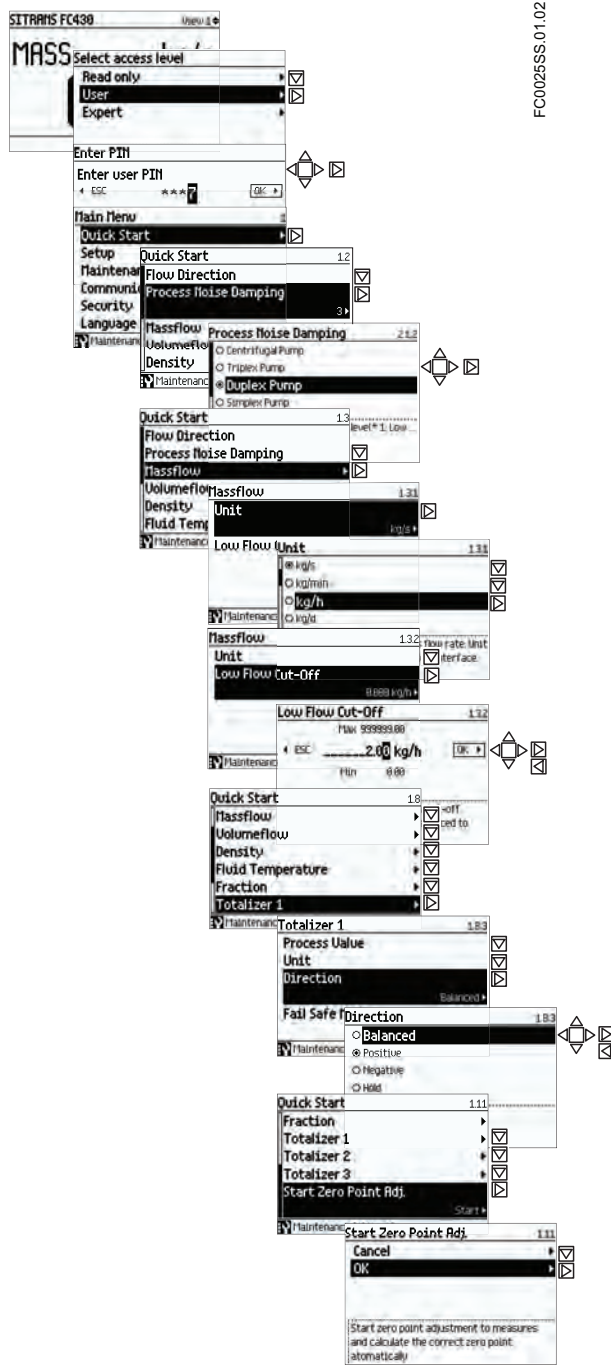

6.3.4 Zero point adjustment

The flowmeter system is optimized through a zero point adjustment which is accessed via the menu item 1.11 "Start Zero Point Adj." in the Quick Start menu.

Performing a zero point adjustment

Note

Preconditions

Before a zero point adjustment is initiated, the pipe must be flushed, filled and at an absolute flowrate of zero preferably also at operating pressure and temperature.

1. Flush out any gases and obtain stable temperature conditions by running flow at operational conditions for minimum 30 minutes.

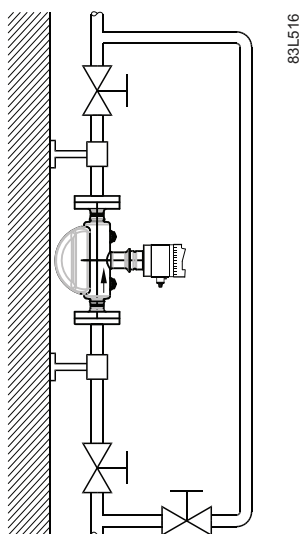

Figure 6-1 Best practice zero point adjustment with a by-pass line and two shut-off devices

2. Close the outlet shut-off valve while maintaining the system pressure. If bypass flow is necessary, open the bypass valve. If the pressure can be increased by 1 to 2 bars with stopped flow, this should be applied.
3. Wait 1 to 2 minutes, for the system to settle, and then perform zero adjustment. Waiting longer can change the temperature.
4. During the process a progress bar is visible.
5. At the end of the zero adjustment, the outcome is displayed as an offset and standard deviation.

6.4 Commissioning with PDM

This chapter describes how to commission the device via SIMATIC PDM.

6.4.1 Operating via SIMATIC PDM

SIMATIC PDM is a software package used to commission and maintain process devices. Further information can be found at: www.siemens.com/simatic-pdm.

6.4.2 Functions in SIMATIC PDM

Note

- For a complete list of parameters, see the "LUI menu structure" (Page 203).
 - While the device is in PROGRAM mode the output remains fixed and does not respond to changes in the device.
-

SIMATIC PDM monitors the process values, alarms and status signals of the device. It allows you to display, compare, adjust, verify, and simulate process device data; also to set schedules for calibration and maintenance.

Parameters are identified by name and organized into function groups. See "LUI menu structure" (Page 203) for a table ¹⁾ and "Changing parameter settings using SIMATIC PDM" (Page 87) for more details.

See "Parameters accessed via drop-down menus" (Page 88) for parameters that do not appear in the menu structure in SIMATIC PDM.

¹⁾: The menu structure for SIMATIC PDM is almost identical to that for the LUI.

6.4.3 Features of SIMATIC PDM Rev. 6.1, SP4

The graphic interface in SITRANS FC430 makes monitoring and adjustments easy.

Feature	Function
Wizard Quick Start (Page 78)	Device configuration for simple applications
Wizard Zero Point adjustment (Page 86)	Perform automatic zero point adjustment
Process variables (Page 91)	Monitor process variables and flow trend

6.4.4 Initial setup

To ensure that SIMATIC PDM connects properly, please complete the two processes outlined below:

1. Deactivating buffers
2. Updating the Electronic Device Description (EDD)

Deactivating buffers for RS232 com port

This deactivation is required to align SIMATIC PDM with the HART modem for Windows® 2000 and Windows® XP operating systems.

Note

- SIMATIC PDM operates only in the Windows XP Professional version, not in the Home version.
- You need administrative rights on your operating system to deactivate buffers.

1. Click "Start/Settings/Control Panel" to begin configuration.
2. Double click "System", select the "Hardware" tab, and click the "Device Manager" button.
3. Open "Ports" folder and double click the COM Port used by the system to open the "Communications Port Properties" window.
4. Select the "Port Settings" tab and double click the "Advanced" button.
5. If the "Use FIFO buffers" radio box is selected, click to deselect.

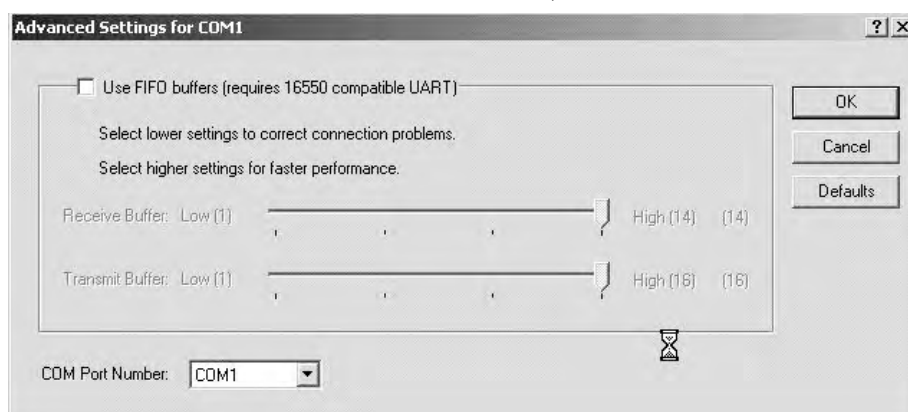

6. Click "OK" to close out. Close all screens and then reboot.

Updating the Electronic Device Description (EDD)

You can locate the EDD in Device Catalog, under "Sensors/Flow/Coriolis/Siemens AG/SITRANS FC430". Check the product page of our website at: www.siemens.com/FC430, under Downloads, to make sure you have the latest version of SIMATIC PDM, the most recent Service Pack (SP) and the most recent hot fix (HF).

Installing a new EDD:

1. Download the EDD from the product page of our website at: www.siemens.com/FC430 and save the files to your computer.
2. Extract the zipped file to an easily accessed location.
3. Launch "SIMATIC PDM – Manage Device Catalog", browse to the unzipped EDD file and select it.

6.4.5 Configuring a new device

Note

Clicking on "Cancel" during an upload from device to SIMATIC PDM will result in some parameters being updated.

1. Check that you have the most recent EDD, and if necessary update it, see "Updating the Electronic Device Description (EDD)" in "Initial setup" (Page 76).
2. Launch "SIMATIC PDM – Manager Device Catalog", browse to the unzipped EDD file and select it.
3. Launch SIMATIC Manager and create a new project for FC430. An Application Guide for setting up HART devices with SIMATIC PDM can be downloaded from the product page of our website at: www.siemens.com/FC430.
4. After the reset is complete upload parameters to the PC/PG.
5. Configure the device via the Wizard Quick Start.

6.4.6 Wizard - Quick Start via PDM

The graphic Quick Start Wizard provides an easy 7-step procedure that configures the device for a simple application.

Please consult the SIMATIC PDM operating instructions or online help for details on using SIMATIC PDM.

1. If you have not already done so, check that you have the most up-to-date Electronic Device Description (EDD) for your instrument, see "Configuring a new device" (Page 78).
2. Launch SIMATIC Manager and create a new project for FC430. (Application Guides for setting up HART devices with SIMATIC PDM can be downloaded from the product page of our website at: www.siemens.com/FC430).

Quick start

Note

- The Quick Start wizard settings are inter-related and changes apply only after you click on "Apply and Transfer" at the end of step 7 to save settings offline and transfer them to the device.
 - Do not use the Quick Start Wizard to modify individual parameters.
 - Click on "Back" to return and revise settings or "Cancel" to exit the Quick Start.
-

Launch SIMATIC PDM, open the menu "Device – Wizard - Quick Start", and follow steps 1 to 7.

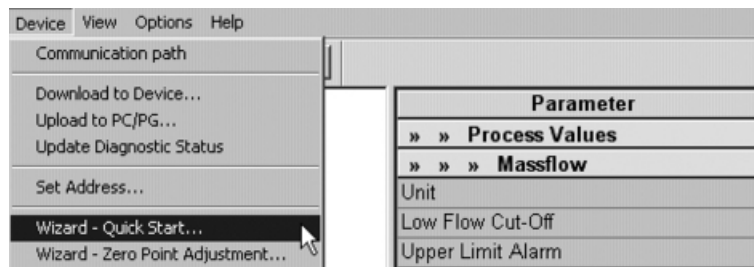

Step 1 - Identification

Note

The layout of the dialog boxes shown may vary according to the resolution setting for your computer monitor.

1. Click on "Read Data from Device" to upload Quick Start parameter settings from the device to the PC/PG and ensure PDM is synchronized with the device.
2. If required, change the language for the local user interface.
3. Click on "Next" to accept the default values. ("Descriptor", "Message", and "Date" fields can be left blank.)

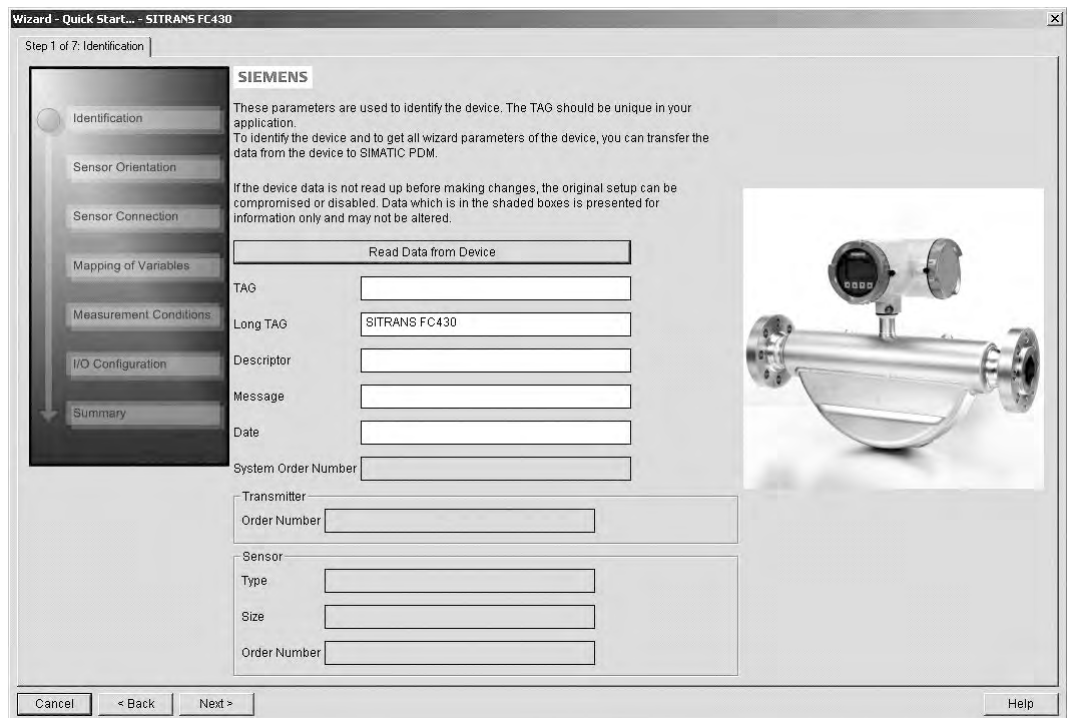

Step 2 - Sensor orientation

Select the application type (gas or liquid) and sensor orientation, then click on "Next".

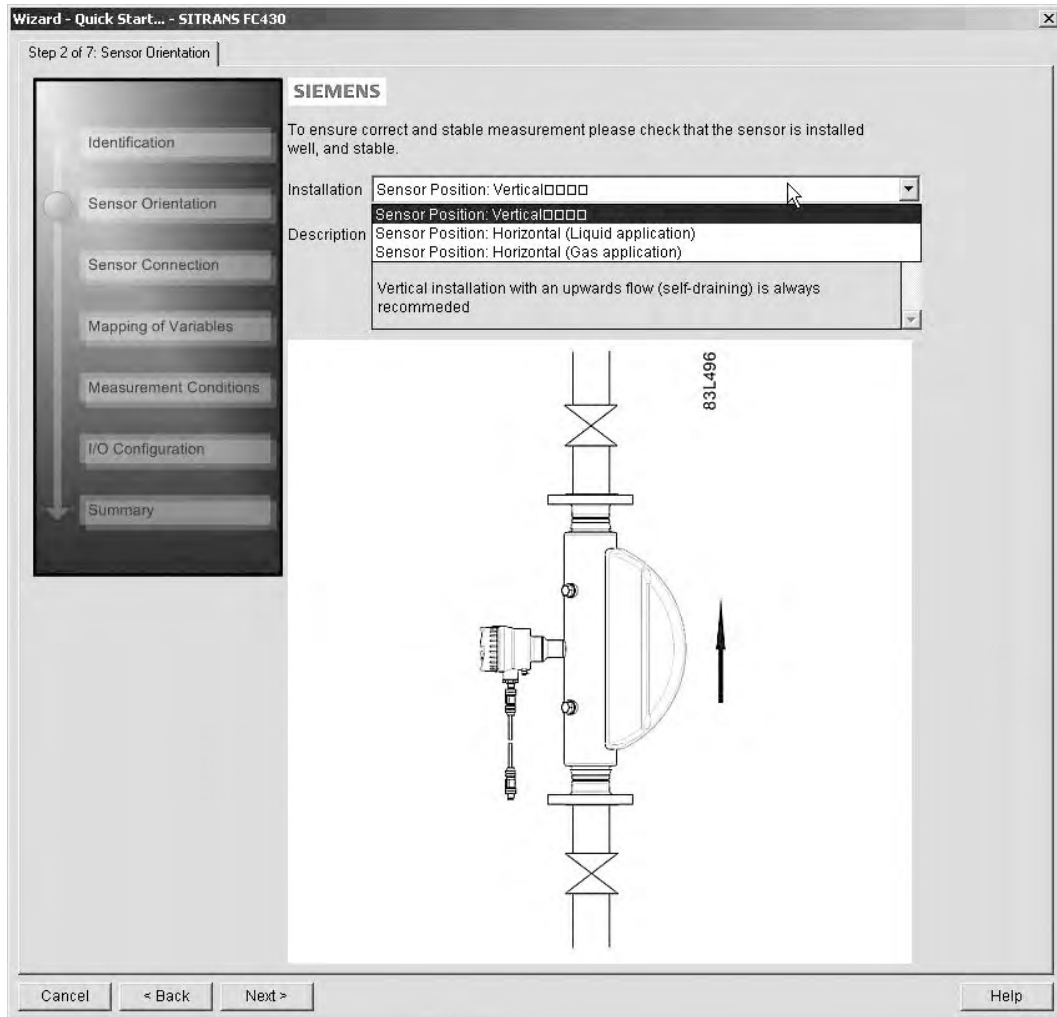

Step 3 - Sensor connection (remote version only)

A remote system can be ordered with M12 connection or with terminated cable (for example conduit connections)

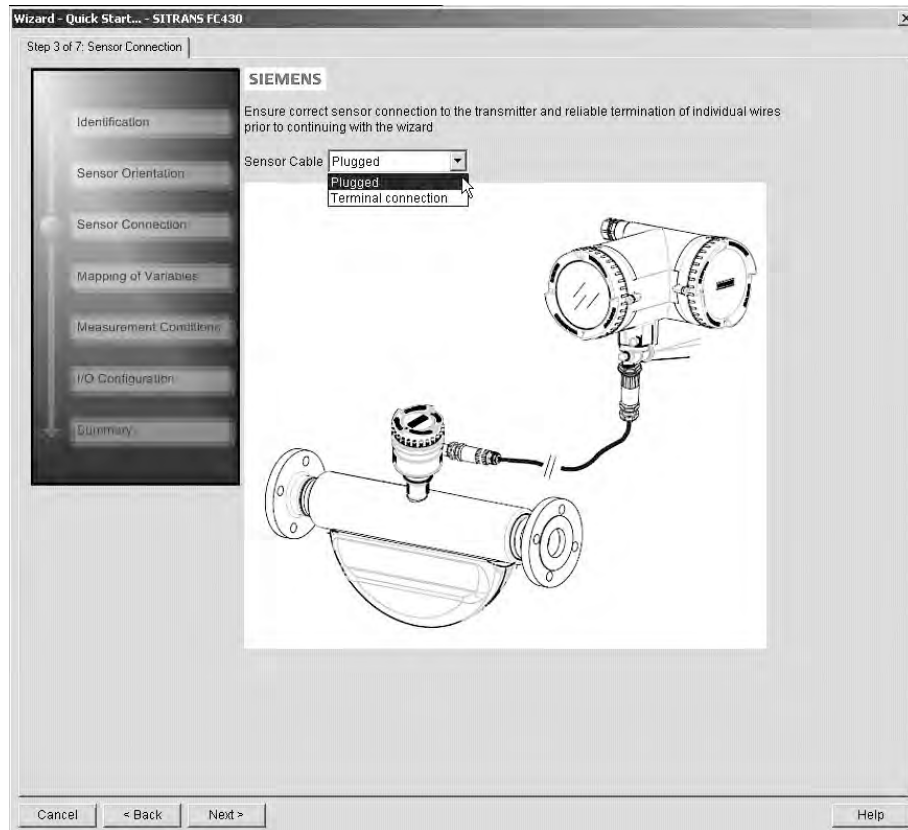

Step 4 - Mapping of variables

Set the process values (PV, SV, TV, and QV) to be used in the HART system integration and click on "Next".

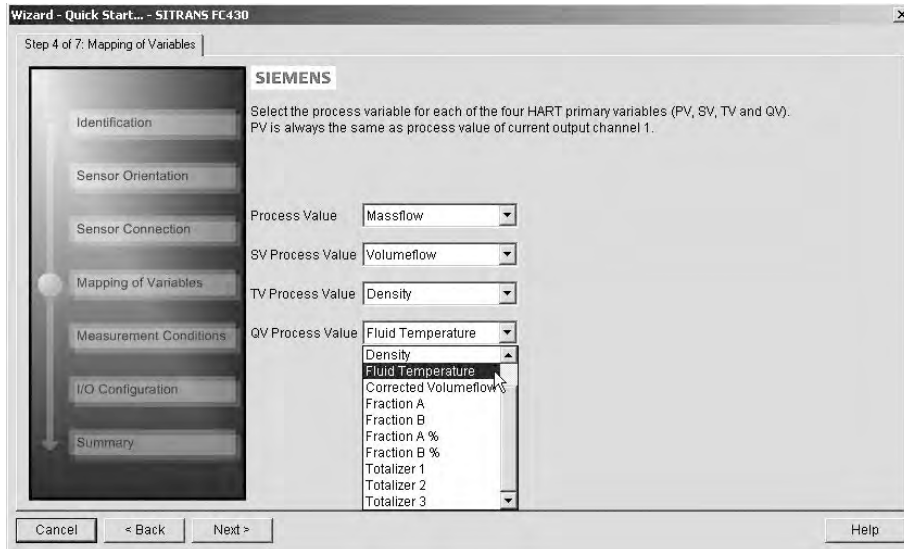

Step 5 - Measurement conditions

Configure the measurement conditions for the selected process variables. Change "Flow Direction" if necessary.

Wizard - Quick Start... - SITRANS FC430

Step 5 of 7: Measurement Conditions

SIEMENS

Basic Settings

Flow Direction: Positive

Pulsating Flow ...

Massflow

Unit: kg/s

Low Flow Cut-Off: 0 kg/s

Upper Limit Alarm: 1023 kg/s

Upper Limit Warning: 1023 kg/s

Lower Limit Warning: -1023 kg/s

Lower Limit Alarm: -1023 kg/s

Alarm Hysteresis: 0 kg/s

Volumeflow

Unit: m³/s

Low Flow Cut-Off: 0 m³/s

Upper Limit Alarm: 0,177 m³/s

Upper Limit Warning: 0,177 m³/s

Lower Limit Warning: -0,177 m³/s

Lower Limit Alarm: -0,177 m³/s

Alarm Hysteresis: 0 m³/s

Density

Unit: kg/m³

Empty Tube Detection: Off

Upper Limit Alarm: 20000 kg/m³

Upper Limit Warning: 20000 kg/m³

Lower Limit Warning: 0 kg/m³

Lower Limit Alarm: 0 kg/m³

Alarm Hysteresis: 0 kg/m³

Fluid Temperature

Unit: °C

Upper Limit Alarm: 200 °C

Upper Limit Warning: 200 °C

Lower Limit Warning: -50 °C

Lower Limit Alarm: -50 °C

Alarm Hysteresis: 0 °C

Cancel < Back Next > Help

Reduce the sensitivity of the flow measurement signal by clicking on the "Pulsating Flow" button and selecting the appropriate filter.

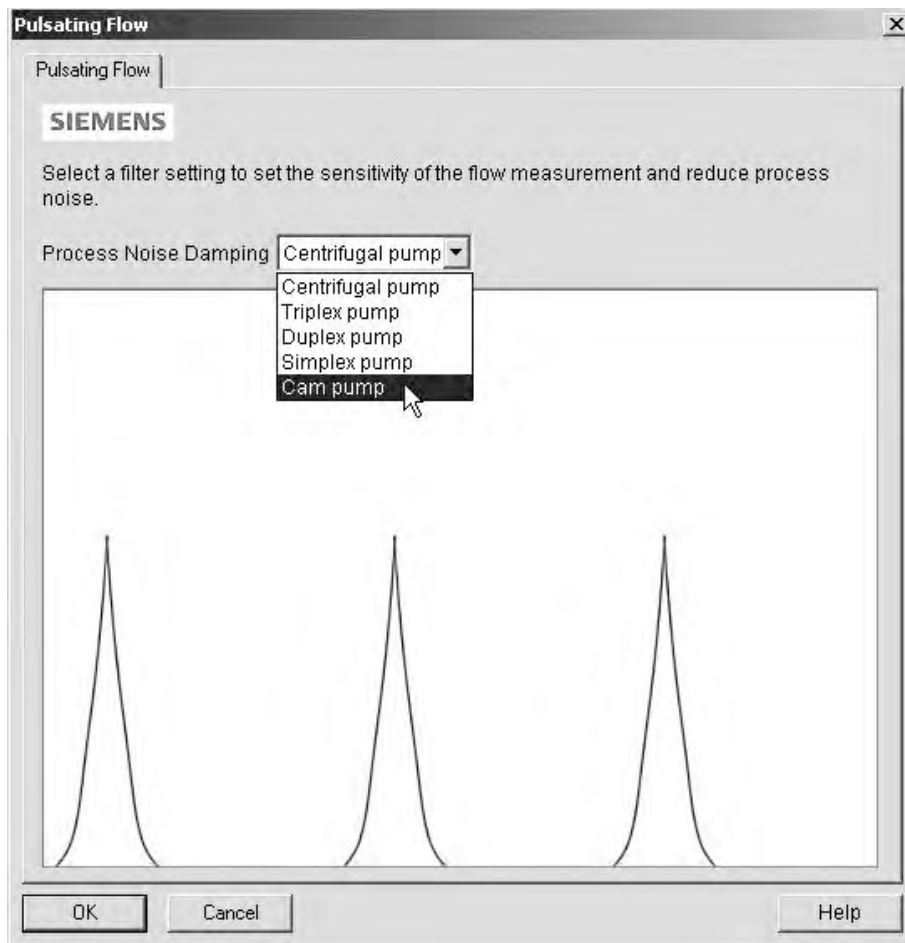

Step 6 - I/O configuration

Configure the current output (channel 1). The process value is selected as PV in step 4 "Mapping of variables".

Configure channels 2, 3 and 4, if ordered. For each channel: Select the "Operation Mode" and click on the button below for detailed configuration.

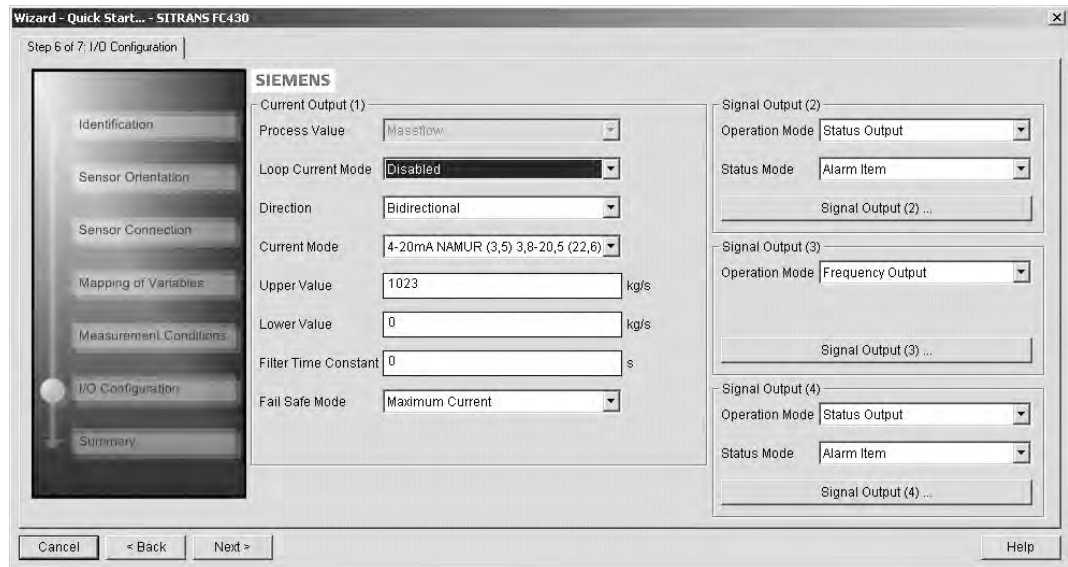

Step 7 - Summary

Check parameter settings, and click on "Back" to return and revise values, "Apply" to save settings offline, or "Apply and Transfer" to save settings offline and transfer them to the device.

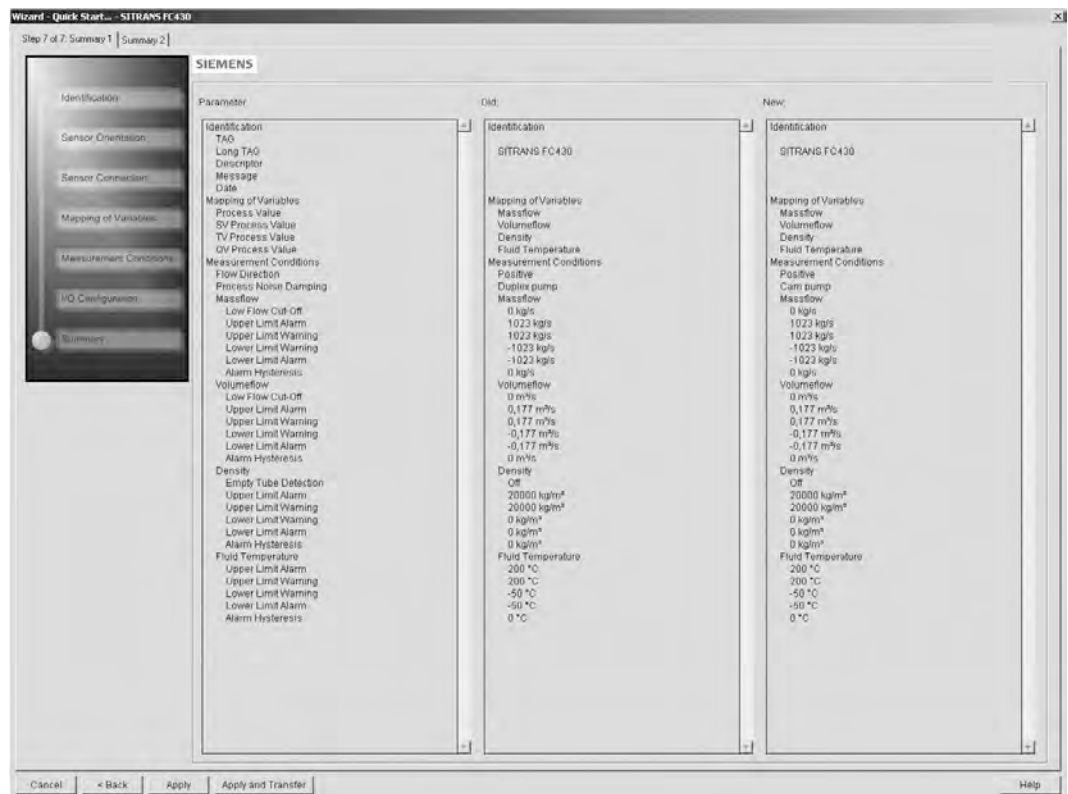

The message "Quick Start was successful" will appear. Click on "OK".

6.4.7 Wizard - Zero Point adjustment

Open the menu Device – Wizard - Zero Point Adjustment.

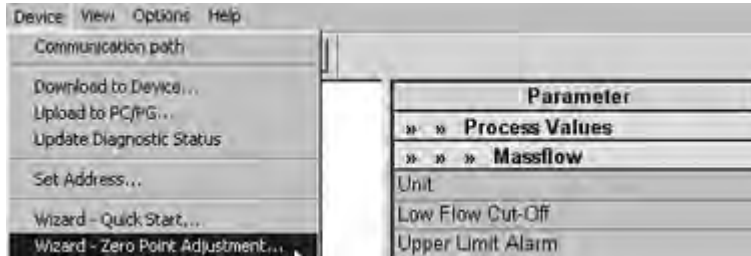

Select "Auto". Click on "Next".

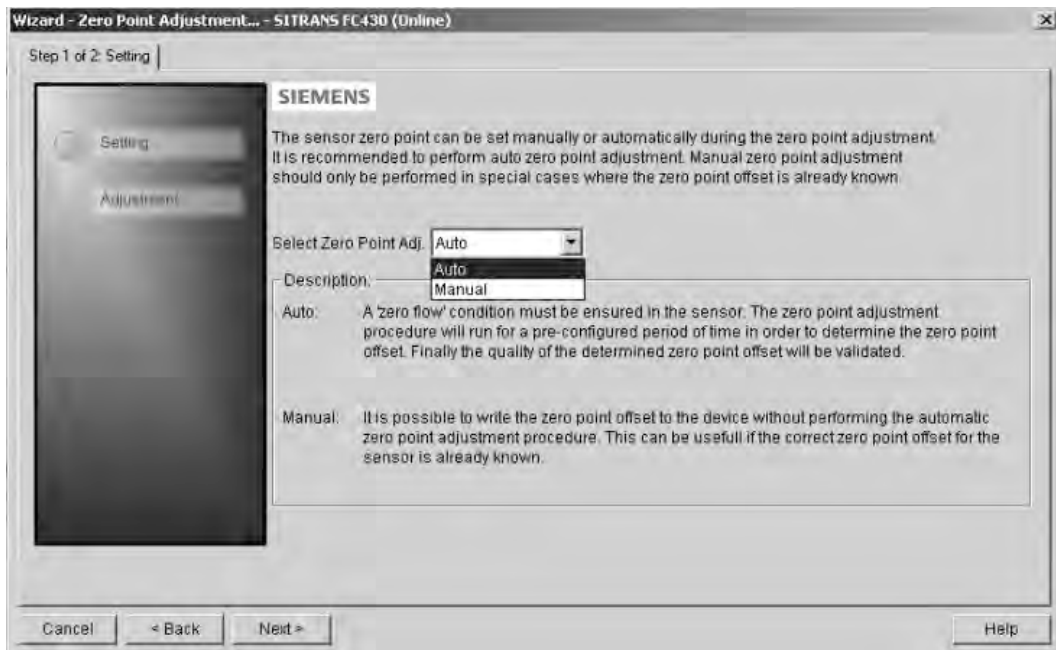

It is recommended to use the default settings. Change the "Zero Point Adjustments Settings", if necessary.

Click on "Auto Zero Point Adjustment".

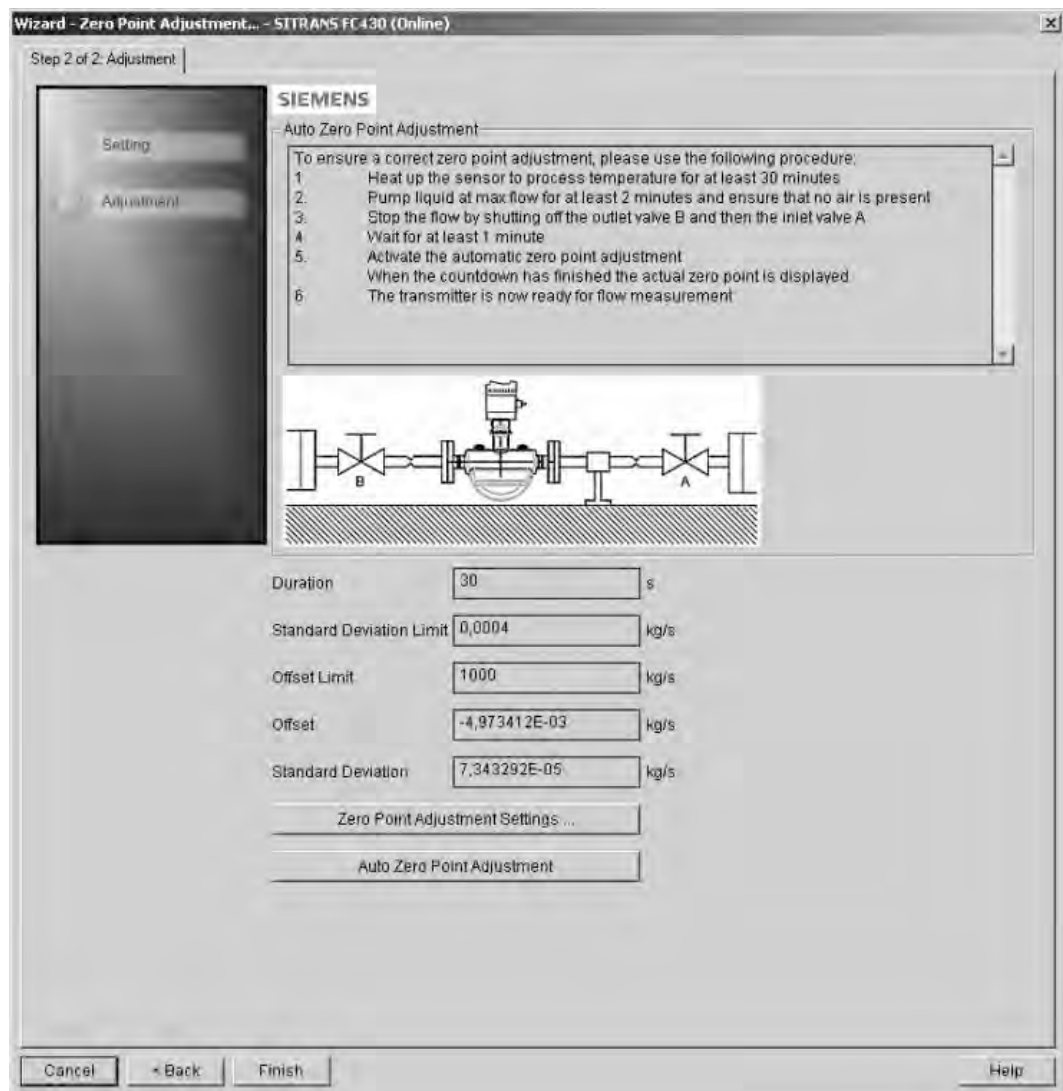

6.4.8 Changing parameter settings using SIMATIC PDM

Note

For a complete list of parameters, see the "LUI menu structure" (Page 203).

Clicking on "Cancel" during an upload from device to SIMATIC PDM will result in some parameters NOT being updated.

Many parameters are accessed via the online menus in PDM, see "Parameters accessed via drop-down menus" for the others.

6.4 Commissioning with PDM

1. Launch SIMATIC PDM, connect to SITRANS FC430, and upload data from the device.
2. Adjust parameter values in the parameter value field then click on "Enter". The status fields read "Changed".
3. Open the "Device" menu, click on "Download to device", then use "File – Save" to save settings offline. The status fields are cleared.

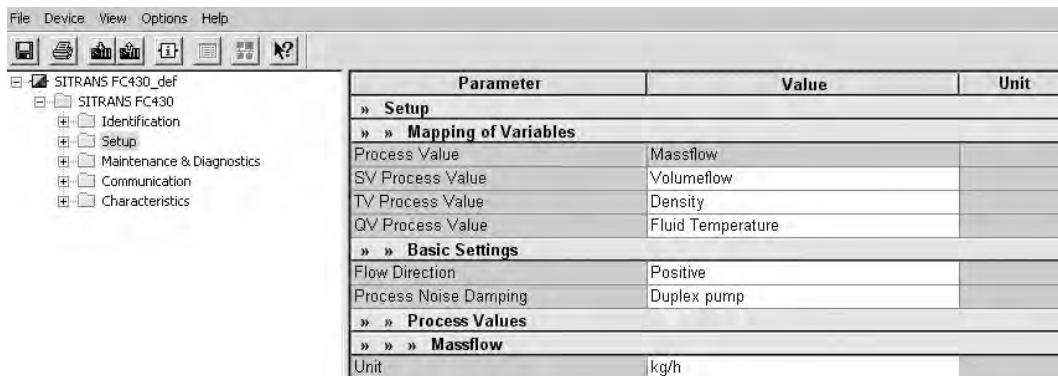

6.4.9 Parameters accessed via drop-down menus

Click on "Device" or "View" to open the associated drop-down menus.

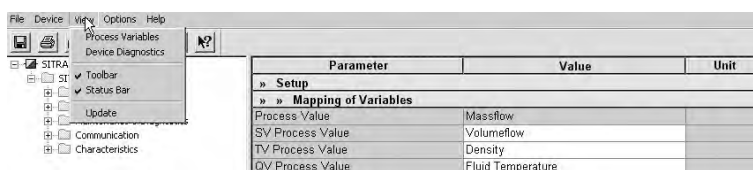

Drop-down menus

Table 6-1 Device menus

Device menus	Description
Communication Path	Shows the communication interface (HART modem)
Download to Device	Downloads all writable parameters to the device
Upload to PC/PG	Uploads all parameters from the device to the parameter table
Update Diagnostic Status	Reads current diagnostic status from the device and updates the diagnostic status icon
Set Address	Sets the HART polling address
Wizard - Quick Start	Guide for a quick commissioning
Wizard - Zero Point Adjustment	Guide for zero point adjustment (automatic and manual)
D/A Trim (online dialog)	Calibration of current output (channel 1)
Totalizer (online dialog)	Controlling totalizers 1, 2 and 3
Dosing (online dialog)	Controlling the dosing function
Maintenance (online dialog)	Setup of maintenance functions

Device menus	Description
Simulation (online dialog)	Simulation of process values, alarms, and inputs/outputs (channels 2 to 4)
Loop Test (online dialog)	Simulation of current output (channel 1)
Access Management	Possibility to upgrade access level from "user" to "expert" and to change PIN code for "expert" level
Reset (online dialog)	Resets device to default settings or restarts device
Configuration Flag Reset (online dialog)	Commands reset the configuration flag
HART Communication (online dialog)	Number of preamples

Table 6-2 View menus

View menus	Description
Process Variables (online dialog)	Shows all process values
Device Diagnostic (online dialog)	Shows all diagnostics information (alarms and diagnostics parameters)
Toolbar (online dialog)	Shows/hides the toolbar
Status Bar	Shows/hides the status bar
Update	Updates the content of the active window

6.4.10 Zero point adjustment

The flowmeter system is optimized through a zero point adjustment.

Performing a zero point adjustment

Note

Preconditions

Before a zero point adjustment is initiated, the pipe must be flushed, filled and at an absolute flowrate of zero preferably also at operating pressure and temperature.

1. Flush out any gases and obtain stable temperature conditions by running flow at operational conditions for minimum 30 minutes.

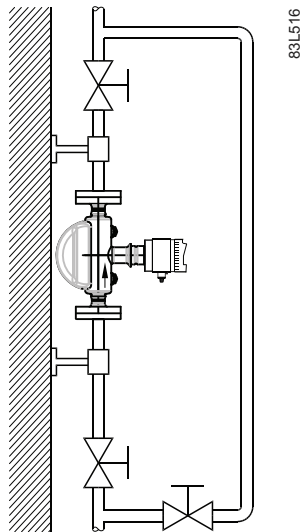
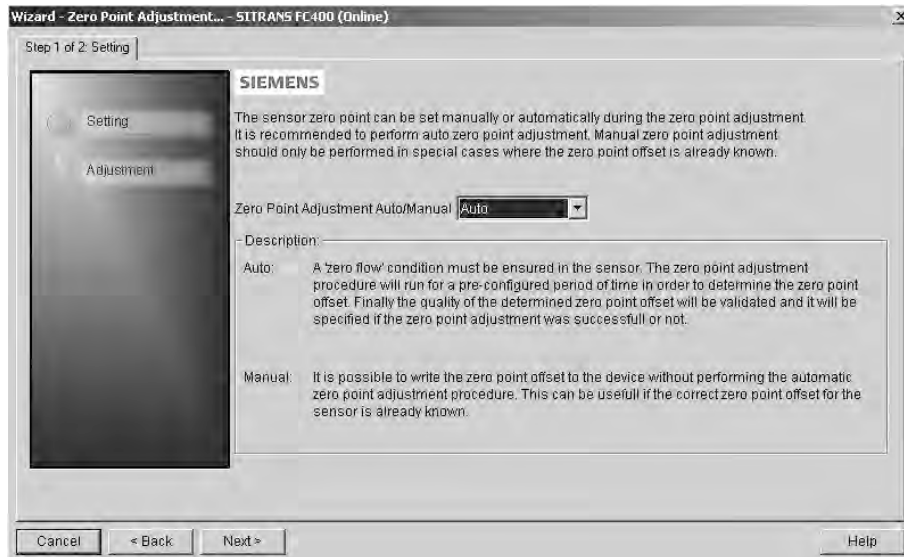

Figure 6-2 Best practise zero point adjustment with a by-pass line and two shut-off devices

2. Close the outlet shut-off valve while maintaining the system pressure. If bypass flow is necessary, open the bypass valve. If the pressure can be increased by 1 to 2 bars with stopped flow, this should be applied.
3. Wait 1 to 2 minutes, for the system to settle, and then perform zero adjustment. Waiting longer can change the temperature.
4. Select "Device->Wizard - Zero Point Adjustment" from the main menu of SIMATIC PDM to perform an automatic zero point adjustment.



5. Click "Next" and then "Auto Zero Point Adjust".

6. During the process a progress bar is visible.
7. At the end of the zero adjustment, the outcome is displayed as an offset and standard deviation.

Note

If you get an error message after the zero point adjustment, refer to "Alarms and system messages" (Page 151).

The system is now ready for normal operation.

6.4.11 Process variables

1. To compare outputs in real time select "View->Process variables" to see all process values, totalizers and loop current.
2. Verify that the process values show the expected values.

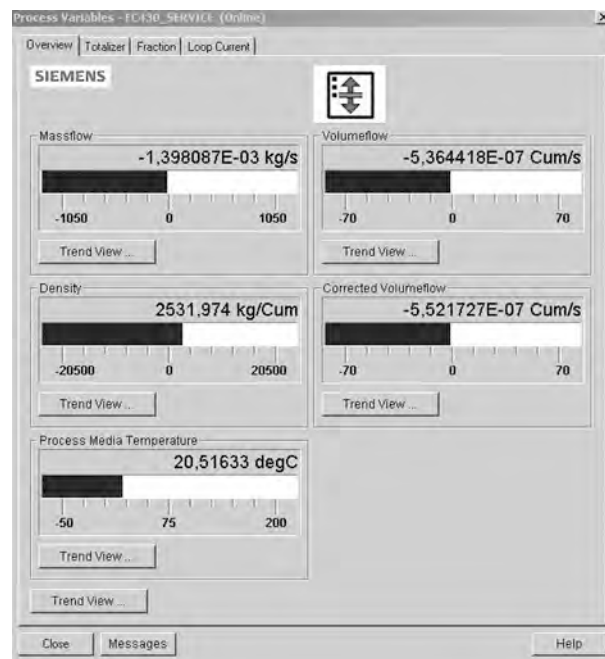

Figure 6-3 View process variables

Trend view

Open the menu "View->Process variables" and click on a "Trend view" button to monitor the trend of one or all process values available at each tab.

A considerable amount of information regarding the operation and status of the flow meter is available to the user via Local User Interface (LUI) and SIMATIC PDM.

7.1 Local User Interface (LUI)

Operation via local user interface

The device is operated with the capacitive proximity keypad on the local user interface.

The elements are actuated by touching the glass panel above the appropriate key. The text display above the operating elements gives a menu-guided operation of the individual device function/parameters. Successful operation of the key is confirmed by a small green LED at the right of the display.

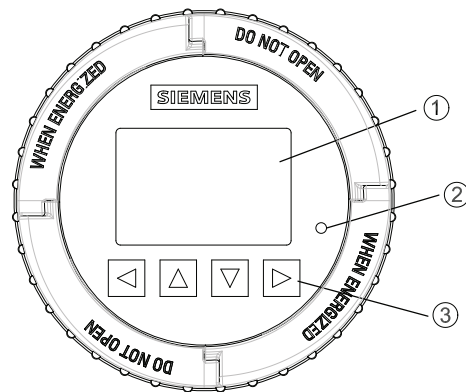

- ① Full graphical display
- ② LED (for indication of key operation)
- ③ Capacitance proximity keypad

Figure 7-1 Local user interface

Note

Recalibration of the keypad

When the lid is mounted, all keys are recalibrated (approximately 40 seconds). During recalibration the LED is on and the keys cannot be operated.

If one of the keys is pressed for more than 10 seconds, this key is recalibrated (less than 10 seconds). Release the key for further operation.

Note

LUI timeout

If no key is pressed for 10 minutes, the display switches to show operation view.

Note

Operation does not require opening of the device. This means that the high degree of protection of IP67 and safety in hazardous locations are guaranteed at all times.

Note

Motor fuel dispensers

The Local User Interface is not suitable as an indication device for motor fuel dispensers.

7.1.1 Display view structure

There are three view types:

- **Operation view**

The operator view shows up to six operation views (Page 98). The operation views are fully configurable to show different process values in different operation view types. Depending on the operation view type configuration the view is either measurement view or alarm view.

 - Measurement view: Displays the measurement values.
 - Alarm view: Displays the active alarms in a list.
- **Navigation view**

The navigation view (Page 104) shows the menus and parameters. The navigation view is used to navigate to the menus and parameters in the device.
- **Parameter view**

The parameter view (Page 110) can be entered from the navigation view. The parameter view is used to view and edit the parameters.

Navigating the operation view

Browse the operation views and menu items using the control buttons as follows:

Table 7-1 Measurement view





Key	Function
	No functionality
	Go to the previous menu in the operation view
	Go to the next menu in the operation view
	Enter the navigation view

Table 7-2 Alarm view level 1





Key	Function
	No functionality
	Go to the previous menu in the operation view
	Go to the next menu in the operation view
	Enter alarm view level 2

Table 7-3 Alarm view level 2









Key	Function
	Enter alarm view level 1
	Select the item above in the list; keep pressing the key to accelerate scrolling up the selection list
	Select the item below in the list; keep pressing the key to accelerate scrolling down the selection list
	Enter alarm view level 3

Table 7-4 Alarm view level 3

Key	Function
	Enter alarm view level 2
	No functionality
	No functionality
	No functionality

The following graphic shows an example of how to navigate between measurement views and alarm views with measurement views 1, 3, and 4 as well as alarm view 5 enabled.

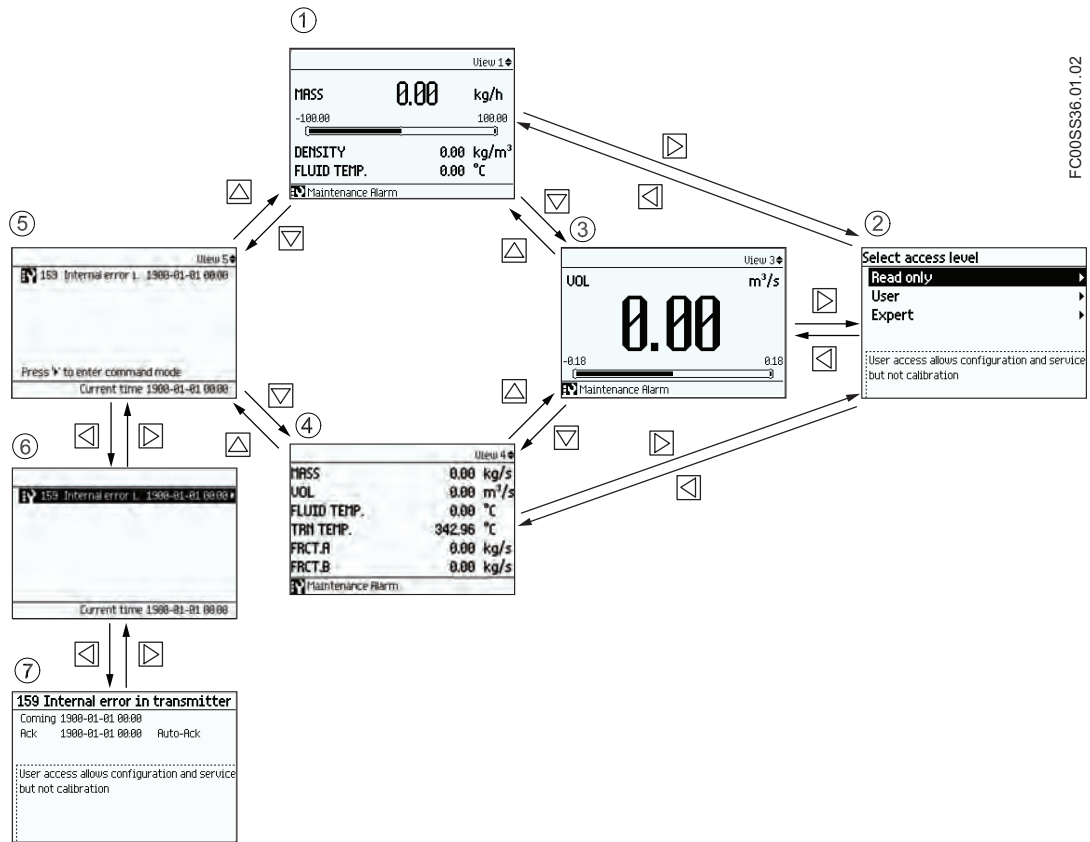

FC00SS36.01.02



- ① Measurement view
- ② Access level view
- ③ Measurement view
- ④ Measurement view
- ⑤ Alarm view - level 1
- ⑥ Alarm view - level 2
- ⑦ Alarm view - level 3

Navigating the navigation view

Browse the navigation view and menu items using the control buttons as follows:

Table 7-5 Navigation view

Key	Function
	Enter the next higher level of the navigation view (for example from level 2 to level 1). If located on level 1 in the navigation view then enter the operation view
	Select the item above in the list; keep pressing the key to accelerate scrolling up the selection list. If the key is pressed when the top item is selected, the bottom item will be highlighted

Key	Function
	Select the item below in the list; keep pressing the key to accelerate scrolling down the selection list. If the key is pressed when the bottom item is selected, the top item will be highlighted
	Enter the next lower level of the navigation view (for example from level 1 to level 2). If a parameter is selected in the navigation view then enter the parameter view

Editing the parameters

When this symbol  is shown in the graphics, the four buttons on the LUI are used for changing the parameters as described below.

Table 7-6 Parameter edit view









Key	Function
	Select the next left position. If the most left position is selected, exit the parameter edit view without confirming the changes. Keep pressing the key to jump to the most left position
	Change the selected number/character. Numeric characters: increase the number by one (for example from 7 to 8) ASCII characters: select the previous character in the alphabet
	Change the selected number/character. Numeric characters: decrease the number by one (for example. from 8 to 7) ASCII characters: select the next character in the alphabet
	Select the next right position. If most right position is selected, confirm the change and exit the parameter edit view. Keep pressing the key to jump to the most right position

Table 7-7 Parameter read only view

Key	Function
	Exit parameter edit view
	No functionality
	No functionality
	No functionality

7.1.2 Access control

The user can view all parameters in the LUI menu but the parameters are protected against changes with access level control. The user gains access when entering navigation view by selecting one of following access levels.

- Read Only
Allows no configuration. The user is only able to view the parameter values. No PIN code required.
- User
Allows configuration and service of all parameters except calibration parameters. Default PIN code is 2457.
- Expert
Allows configuration and service of all parameters including flow and density calibration parameters. Default PIN code is 2834.

PIN codes can be changed in menu 5 "Security".

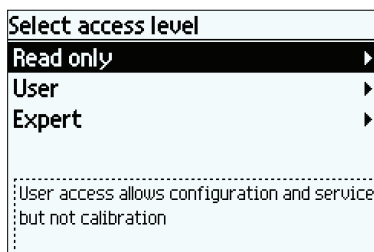



The exact structure of the operating menu is explained in the "LUI menu structure" (Page 203).

Note

Lost PIN code

If the PIN code is lost, provide Siemens customer support with transmitter serial number (see nameplate) and PUK number (menu item 5.1.4). Siemens customer support will provide a code to be entered in "Reset PINs" (menu item 5.1.3).

7.1.3 Operation view

The operation view can be displayed in up to six user-configured views. Switch manually between the enabled views with the keys  and . The actual operator view number (1 to 6) is shown in the upper right corner of the figures below.

The view types including the number of process values shown in the operation view are configured in menu item 2.8 (Page 203). Each view can be configured to show:

- Six Values
- Three Values
- One Value and Bargraph

- Single Value
- Alarm List

Six Values

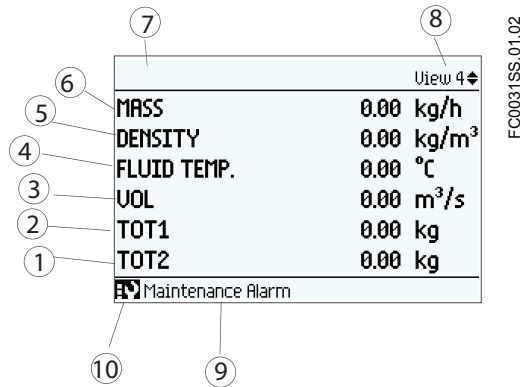

- | | | |
|---|----------------------|--|
| ① | Sixth process value | The user-defined process value to be displayed is configured in menu "View" (1-6) located at "Setup" → "Display" |
| ② | Fifth process value | The user-defined process value to be displayed is configured in menu "View" (1-6) located at "Setup" → "Display" |
| ③ | Fourth process value | The user-defined process value to be displayed is configured in menu "View" (1-6) located at "Setup" → "Display" |
| ④ | Third process value | The user-defined process value to be displayed is configured in menu "View" (1-6) located at "Setup" → "Display" |
| ⑤ | Second process value | The user-defined process value to be displayed is configured in menu "View" (1-6) located at "Setup" → "Display" |
| ⑥ | First process value | The user-defined process value to be displayed is configured in menu "View" (1-6) located at "Setup" → "Display" |
| ⑦ | Long TAG | Describes the measurement point and is shown in all operation views. Can be changed via the menu "Long TAG" (3.1.1). |
| ⑧ | View number | Shows the operation view number (1-6). The number refers to the view number configured in the menu "Setup" → "Display". |
| ⑨ | Alarm status text | Describes the alarm class. Only shown if an alarm is active. |
| ⑩ | Alarm icon | Indicates an active alarm. Shows the alarm class, see Alarms and system messages (Page 151). Only shown if an alarm is active. |

Three Values

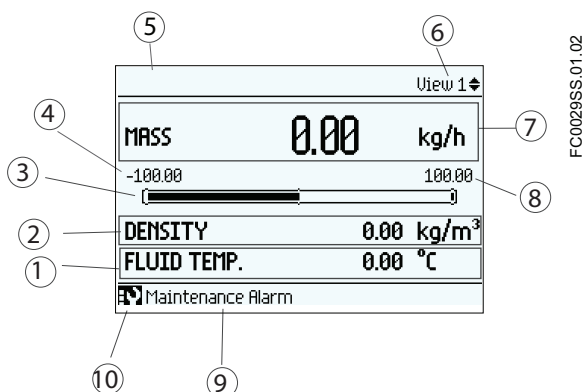

- | | | |
|---|----------------------|--|
| ① | Third process value | The user-defined process value to be displayed is configured in menu "View" (1-6) located at "Setup" → "Display" |
| ② | Second process value | The user-defined process value to be displayed is configured in menu "View" (1-6) located at "Setup" → "Display" |
| ③ | Bar graph | Shows the first process value in relation to its configurable maximum and minimum limits. |
| ④ | Lower Limit Alarm | The lower limit of the bar graph is defined by the lower alarm limit of the selected process value. |
| ⑤ | Long TAG | Describes the measurement point and is shown in all operation views. Can be changed via the menu "Long TAG" (3.1.1). |
| ⑥ | View number | Shows the operation view number (1-6). The number refers to the view number configured in the menu "Setup" → "Display". |
| ⑦ | First process value | The user-defined process value to be displayed is configured in menu "View" (1-6) located at "Setup" → "Display" |
| ⑧ | Upper Limit Alarm | The upper limit of the bar graph is defined by the upper alarm limit of the selected process value. |
| ⑨ | Alarm status text | Describes the alarm class. Only shown if an alarm is active. |
| ⑩ | Alarm icon | Indicates an active alarm. Shows the alarm class, see Alarms and system messages (Page 151). Only shown if an alarm is active. |

Note

Bargraph

The bargraph limits are defined as the lower and upper alarm values.

Massflow

"Massflow Upper Limit Alarm" (menu item 2.2.1.3) and "Massflow Lower Limit Alarm" (menu item 2.2.1.6) define the bargraph limit shown with Massflow on operating view

One Value and Bargraph

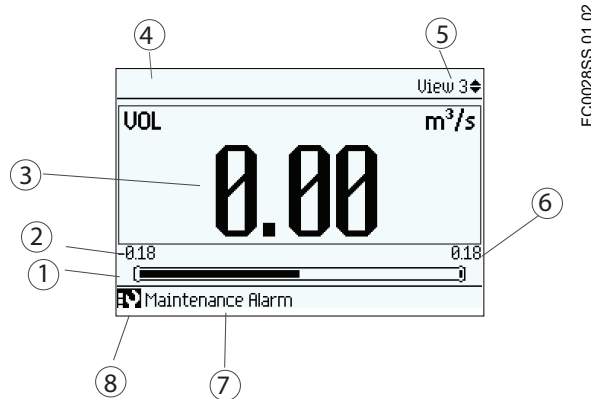

FC0028SS.01.02

- | | | |
|---|-------------------|--|
| ① | Bar graph | Shows the first process value in relation to its configurable maximum and minimum limits. |
| ② | Lower Limit Alarm | The lower limit of the bar graph is defined by the lower alarm limit of the selected process value. |
| ③ | Process value | The user-defined process value to be displayed is configured in menu "View" (1-6) located at "Setup" → "Display" |
| ④ | Long TAG | Describes the measurement point and is shown in all operation views. Can be changed via the menu "Long TAG" (3.1.1). |
| ⑤ | View number | Shows the operation view number (1-6). The number refers to the view number configured in the menu "Setup" → "Display." |
| ⑥ | Upper Limit Alarm | The upper limit of the bar graph is defined by the upper alarm limit of the selected process value. |
| ⑦ | Alarm status text | Describes the alarm class. Only shown if an alarm is active. |
| ⑧ | Alarm icon | Indicates an active alarm. Shows the alarm class, see Alarms and system messages (Page 151). Only shown if an alarm is active. |

Single Value

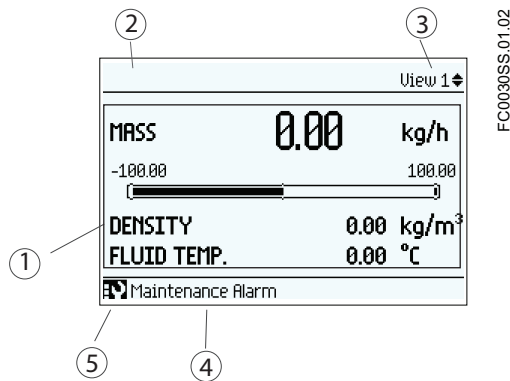

- ① Process value The user-defined process value to be displayed is configured in menu "View" (1-6) located at "Setup" → "Display"
- ② Long TAG Describes the measurement point and is shown in all operation views. Can be changed via the menu "Long TAG" (3.1.1).
- ③ View number Shows the operation view number. The number refers to the view number configured in the menu "Setup" → "Display".
- ④ Alarm status text Describes the alarm. Only shown if an alarm is active.
- ⑤ Alarm icon Indicates an active alarm. Shows the alarm class, see Alarm messages. Only shown if an alarm is active..

Alarm List

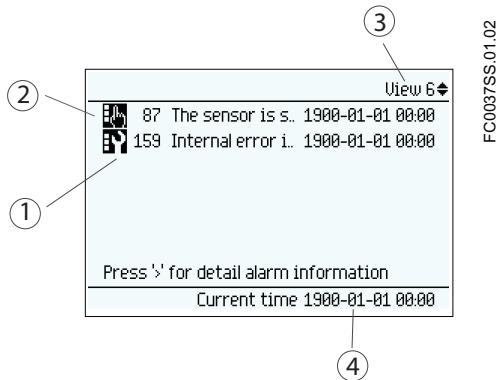

- ① List of alarms List of all active alarms in device
- ② Alarm icon Indicates an active alarm. Shows the alarm class, see Alarms and system messages (Page 151). Only shown if an alarm is active.
- ③ View number Shows the operation view number. The number refers to the view number configured in the menu "Setup" → "Display".
- ④ Time stamp Shows the current date and time.

Figure 7-2 Alarm view level 1

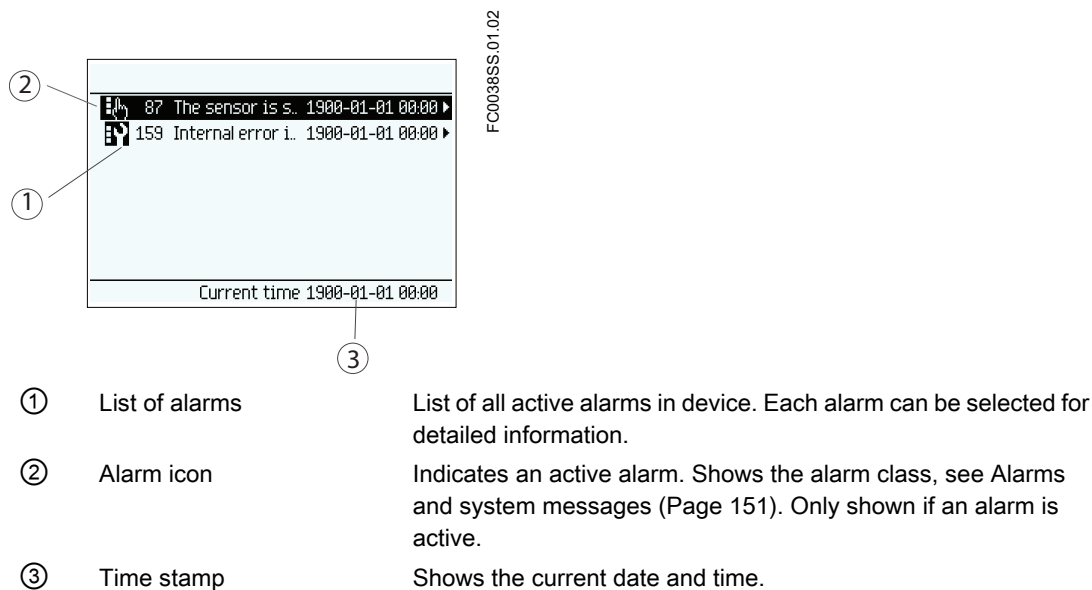

Figure 7-3 Alarm view level 2

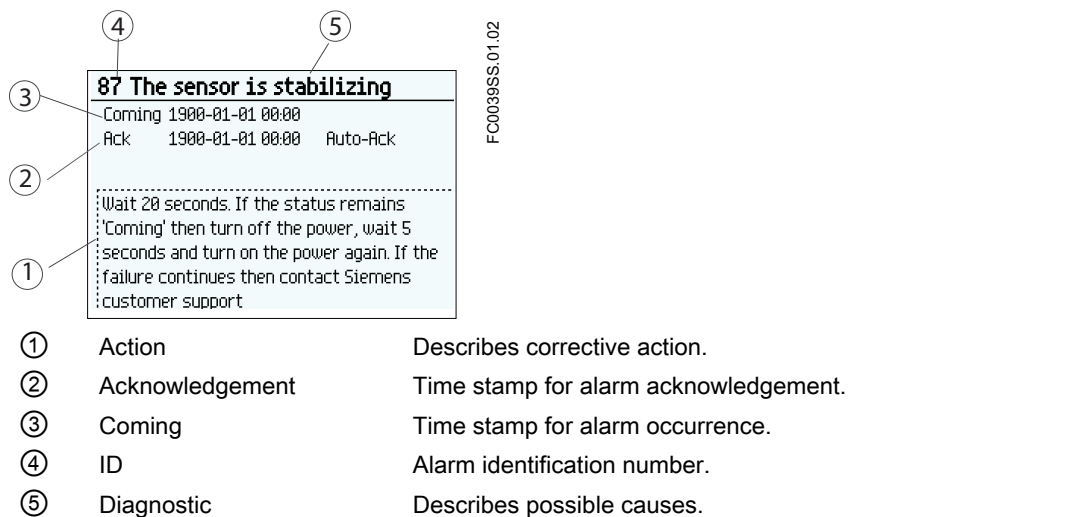

Figure 7-4 Alarm view level 3

Fixed display texts

The following table lists the fixed display texts for the process value names available on the operation view.

Fixed display text	Process value name
MASS	Massflow
VOL	Volumeflow
C.VOL	Corrected Volumeflow
R.DENS.	Reference Density

Fixed display text	Process value name
DENSITY	Density
FLUID TEMP.	Fluid Temperature
FRCT.A	Fraction A
FRCT.B	Fraction B
FRACTION A	Fraction A %
FRACTION B	Fraction B %
TOT ₁	Totalizer 1
TOT ₂	Totalizer 2
TOT ₃	Totalizer 3

7.1.4 Navigation view

Navigation view

The navigation views present the menu structure of the device. All menu items are uniquely identified with menu item number.

Level 1 of the navigation view (entered from the operation view) is standardized for all Siemens Process Instrumentation devices and covers the following groups:

1. Quick Start (menu): Lists the most important parameters for quick configuration of the device. All parameters in this view can be found elsewhere in the menu.
2. Setup (menu): Contains all parameters which are needed to configure the device.
3. Maintenance & Diagnostics (menu): Contains parameters which affect the product behaviour regarding maintenance, diagnostics and service.
Examples: Verification, failure prediction, device health, data logging, alarm logging, report, condition. monitoring, tests, etc.
4. Communication (menu): Contains parameters which describe the HART communication settings of the device.

- 5. Security (menu): Contains parameters which describe all security settings of the device.
- 6. Language (parameter): Parameter for changing the language of the LUI. Regardless of the language setting, the term for this parameter is always the English term (Language).

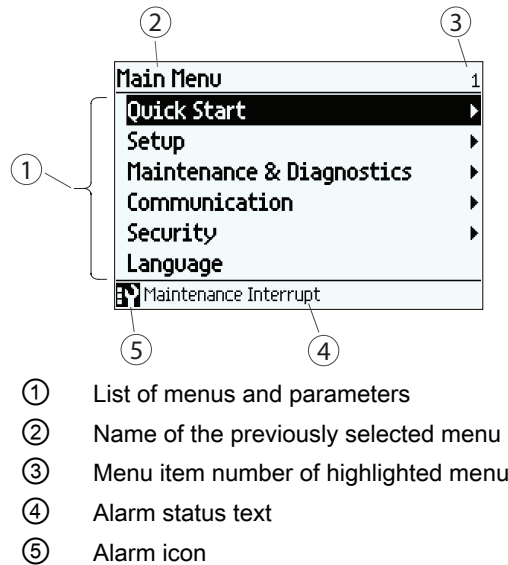

Figure 7-5 Example of display in navigation view

Menu item

In navigation view menus are identified by an arrow in the most right position. When a menu is selected, the background turns black.



Figure 7-6 Menu in navigation view "Quick start" selected "Setup" not selected.

For further information on how to gain access to the menus, see "Access control" (Page 98).

Parameter item

In navigation view parameters are shown without an arrow in the most right position except when the parameter is selected. When selected, the parameter is expanded into two lines; the

second line shows the value of the parameter, a lock icon (🔒) (only for read access level of the parameter), and an arrow in most right position.

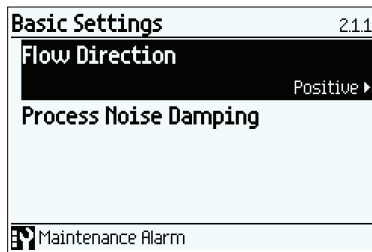

Figure 7-7 Navigation view ReadWrite

The selected parameter can be edited in the parameter view.

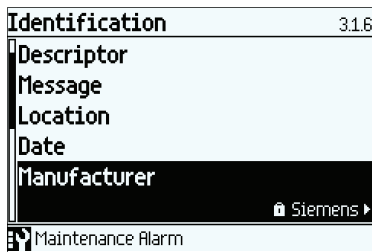

Figure 7-8 Navigation view ReadOnly

The selected parameter can only be viewed in the parameter view

Examples

The following examples show the navigation path from main menu with menu "Setup" selected.



Navigating to parameter "Process Noise Damping"

If the process noise affects the output too much, the outputs can be stabilized by damping the process noise in the application. Navigate to the "Process Noise Damping" parameter as shown in the figure below.

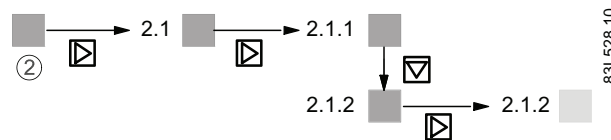

②	Navigation view	Menu	Setup
2.1	Navigation view	Menu	Basic Settings
2.1.1	Navigation view	Menu	Flow Direction
2.1.2	Navigation view	Parameter	Process Noise Damping
2.1.2	Parameter view	Read/Write	Process Noise Damping

Navigating to parameter "Low Flow Cut-Off"

If the output signal must be fixed in case of too low flow, the value at which this is done can be changed. Navigate to the "Low Flow Cut-Off" parameter as shown in the figure below.

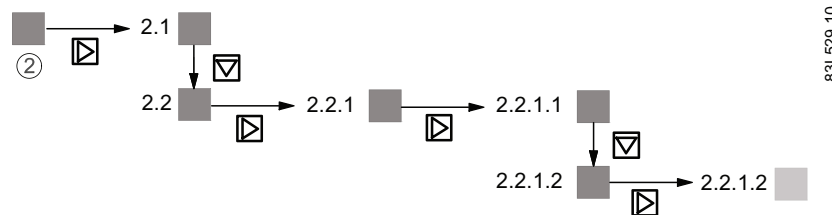

②	Navigation view	Menu	Setup
2.1	Navigation view	Menu	Basic Settings
2.2	Navigation view	Menu	Process Values
2.2.1	Navigation view	Menu	Massflow
2.2.1.1	Navigation view	Menu	Unit
2.2.1.2	Navigation view	Parameter	Low Flow Cut-Off
2.2.1.2	Parameter view	Read/Write	Low Flow Cut-Off

Navigating to parameter "View"

If another parameter is to be shown as first process value in Operation view, the settings for the operator views can be changed. Navigate to the "View" parameter as shown in the figure below.

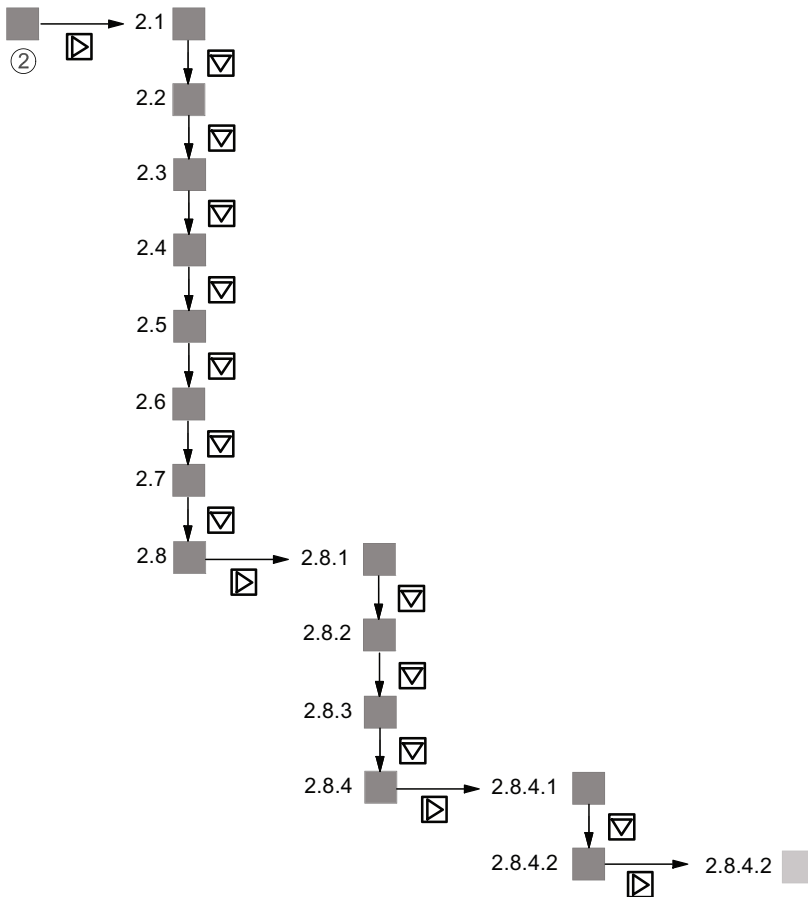

83L530.11

②	Navigation view	Menu	Setup
2.1	Navigation view	Menu	Basic Settings
2.2	Navigation view	Menu	Process Values
2.3	Navigation view	Menu	Totalizers
2.4	Navigation view	Menu	Inputs/Outputs
2.5	Navigation view	Menu	Dosing
2.6	Navigation view	Menu	Zero Point Adjustment
2.7	Navigation view	Menu	Safe Operation
2.8	Navigation view	Menu	Display
2.8.1	Navigation view	Menu	Backlight
2.8.2	Navigation view	Menu	Contrast
2.8.3	Navigation view	Menu	Operator View 1
2.8.4	Navigation view	Menu	Operator View 2
2.8.4.1	Navigation view	Menu	Enable or disable
2.8.4.2	Navigation view	Parameter	View
2.8.4.2	Parameter view	Read/Write	View

7.1.5 Parameter view

Depending upon your access level, you can edit the value of the selected parameter or read the current value.

Numeric parameters edit view

Numeric parameters in edit view are displayed as shown here.

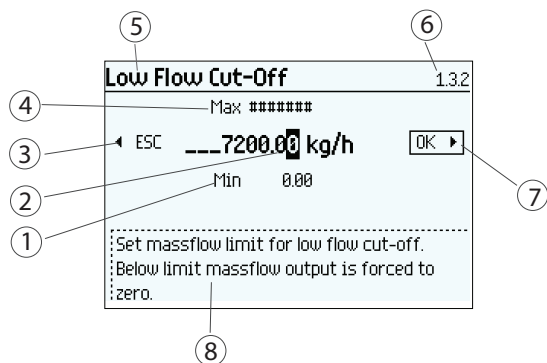

- ① Minimum value
- ② Value to be edited
- ③ Escape without saving (frame around ESC is only shown when cursor is in left-most position)
- ④ Maximum value
- ⑤ Parameter name
- ⑥ Parameter item number
- ⑦ Confirm and save (frame around OK is only shown when cursor is in right-most position)
- ⑧ Help text describing the parameter function. The help text appears if no key is pressed for three seconds.

Figure 7-9 Numeric parameter edit view

Note

signs in display

The display is unable to show the measured value. Change the measurement unit or the resolution.





Changing a value:

1. Select the digit to be changed by pressing and keys.
2. Use key to increase the value and key and decrease the values.
3. Press key in the rightmost position to confirm the changes, or press key in the leftmost position to escape the view without changing the value.

Note

Ensure that the new value is within the minimum/maximum range.

Changing the resolution:

1. Select decimal point by pressing  and  keys.
2. Move decimal point by pressing  key (moves decimal point to the left) or  key (moves decimal point to the right).

In order to change the resolution of the process value shown in the operation view (for example massflow), change the resolution of one configuration parameter for this process value (for example "Low Flow Cut-off" (menu item 2.2.1.2)). Any changes in resolution will change the resolution of all configuration parameters for this process value as well.

Numeric parameter read only view

Numeric parameters in read only view are displayed as shown here.

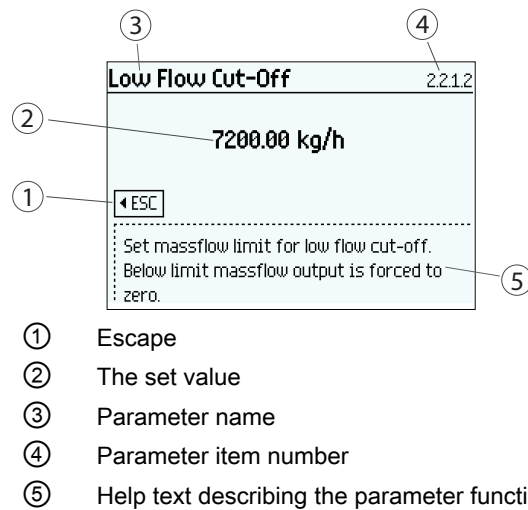

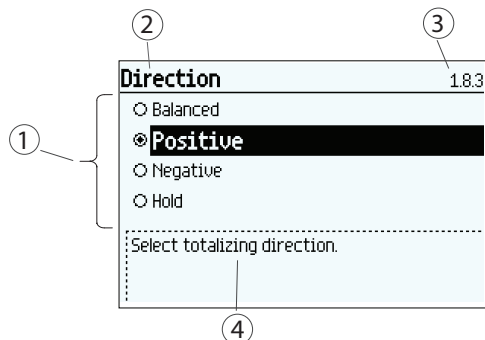

Figure 7-10 Numeric parameter read only view

The read only view is shown if you don't have access to edit parameters. The view shows the set value. Press  to escape the view.

Parameter list edit view

Lists of parameters in edit view are displayed as shown here.



- ① Parameter list
- ② Parameter name
- ③ Parameter item number
- ④ Help text describing the parameter function. The help text appears if no key is pressed for three seconds.

Figure 7-11 List Selection edit view

Select the value by using and keys, and press to confirm changes. Press to escape the view without changing the value.

Parameter list read only view

Lists of parameters in read only view are displayed as shown here.

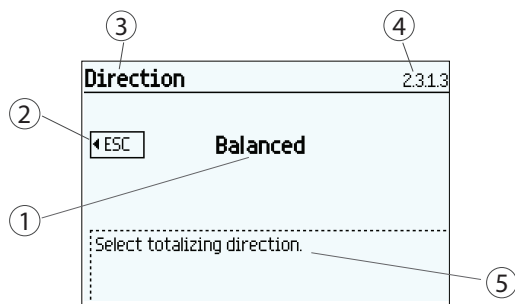

- ① The set parameter
- ② Escape
- ③ Parameter item name
- ④ Parameter item number
- ⑤ Help text describing the parameter function.

Figure 7-12 List selection read only view

The read only view is shown if you don't have access to edit parameters. Press to escape the view.

Functions

In the following the main functionalities of the device are described in detail.

For overview of all functions and parameters, refer to the parameter tables in the appendix "LUI menu structure" (Page 203).

8.1 Process values

The process values are cyclically updated every 10 ms (100 Hz update rate) synchronous with the DSP update cycle.

Process value parameters

The process values¹⁾ are:

- Massflow *
- Volumeflow *
- Corrected volumeflow
- Density *
- Process media temperature
- Fraction A (massflow or volumeflow)
- Fraction B (massflow or volumeflow)
- Fraction A %
- Fraction B %

¹⁾ Only the process variables listed above with * are available to be allocated to the 4-20 mA output on Channel 1. Other process variables are available through HART and all of Channels 2 to 4.

Process value derivations

The front-end of the FCS430 flowmeter measures time and derives the values of certain process variables from those measurements. The time period of vibration of the two measuring tubes is inversely proportional to their frequency, which is used to determine density. The average difference in phase of the two measuring tubes is dependent upon the mass flowrate of the process medium. In this measurement context, phase difference is expressed not in degrees of rotation but as an absolute time measurement. For this reason the result of zero offset correction is displayed in μs , being the unit of the true measurement.

The process variables are interrelated and derived in the following fashions:

8.2 Zero point adjustment

- Massflow: proportional to the phase difference between pickup 1 and pickup 2, with compensations for changes in the metal characteristics due to tube and frame metal temperatures¹⁾.
- Volumeflow: derived directly from the ratio of massflow and media density.
- Corrected volumeflow: derived from the ratio of massflow and reference density²⁾.
- Density: derived from the average frequency of sensor tube vibration with compensation for changes in the metal characteristics with tube temperature. The relationship between density and vibration frequency is an inverse square-law curve which can be fitted to 3 reference points being the densities of air, hot water and cold water.
- Process media temperature: derived from the tube metal temperature. This is a legitimate measurement outcome since the tube walls are thin and they are within a sealed, protected environment, thereby giving similar sensitivity as an insertion thermometer.
- Fraction A (massflow or volumeflow): derived from the combination of media density and temperature, and compared with a stored table of fraction percentage against a wide range of both process values through a fifth-order polynomial³⁾
- Fraction B (massflow or volumeflow): ditto but fraction B is "Flow – A"
- Fraction A %: as for fraction A quantity but A% is the ratio between Fraction A flow and Total flow
- Fraction B %: ditto but B% is "100% – A%"

¹⁾ Metal temperatures are measured using precision Pt1000 sensors. The accuracy of the temperature measurement is ± 1.0 °C.

²⁾ Reference density is the density of the media at reference conditions, normally atmospheric pressure and 20 °C. Reference density can be programmed into the flowmeter menu in two forms, either as a fixed reference or with a selection of linear or square-law temperature dependence. The choice of fixed or calculated reference density and of linear or square-law temperature dependency is according to the application and user preferences.

³⁾ The customer-specified density/temperature tables may be derived from the mass fraction or volume fraction of any two-part mixture. Fraction calculations are naturally performed in the ratio provided, or in mass ratio when using the built-in tables. Volume or mass ratios derived from the fraction table are calculated through the composite media density.

8.2 Zero point adjustment

In the following the automatic zero point adjustment function is described. For further details, see the appendix "Zero point adjustment" (Page 229).

Note

Preconditions

Before a zero point adjustment is initiated, the pipe must be flushed, filled and at an absolute flowrate of zero preferably also at operating pressure and temperature. Refer to "Zero point adjustment" via LUI (Page 74) or PDM (Page 89) for more details.

Note**Change of parameters during zero point adjustment**

Do not change any other parameter during the zero point adjustment procedure.

Automatic zero point adjustment

SITRANS FC430 measures and calculates the correct zero point automatically.

The automatic zero point adjustment of the flowmeter is set by the following parameters:

- Duration
- Start Zero Point Adjustment

When zero adjust is initiated by selecting "Start Zero Point Adjustment", the massflow values are acquired and totalized for the configured period (Duration). The default zero point adjustment period (30 s.) is normally sufficient for a stable zero point measurement.

Note**Extremely low flow quantity**

If the flow quantity is extremely small, extremely precise measurement is necessary. In this case, a long zero point adjustment period can be selected for improved zero point adjustment.

Zero point calculation

During zero point adjustment, an average value is automatically calculated from a large number of samples. The resultant flow value represents an offset from true zero flow. The standard deviation is also calculated which represents the stability of the zero offset value.

Successful automatic zero point adjustment

If the new zero point offset value is valid, it is automatically stored as the new zero point for the sensor. It remains stored in the case of a power failure.

Manual zero point adjustment

In case an automatic zero point adjustment cannot be performed, it is possible to do a manual zero point adjustment by entering the zero point offset value.

1. Select "Manual" in "Select Zero Point Adj." (menu item 2.6.1).
2. Enter the desired value in "Offset" (menu item 2.6.8).

8.3 Low flow cut-off

In certain applications, as for instance dosing applications, 0% flow signals below a certain flowrate are desired. In these applications, the flow signal can be forced to zero, when the flow is lower than a predefined flow value (Low Flow Cut-Off).

SITRANS FC430 provides two parameters for setting the low flow cut-off:

- Low Mass Flow Cut-Off
- Low Volume Flow Cut-Off

The low flow cut-off parameters influence all outputs of the device, for example Local User Interface, Channel 1 to 4, and HART.

Depending on the process values selection of the output either Low Mass Flow Cut-Off or Low Volume Flow Cut-Off will influence the output.

8.4 Empty tube monitoring

The empty tube monitoring function uses the process density for detecting an empty tube. Use of this function is recommended for all standard applications.

Note

Gas applications

Deactivate the empty tube monitoring function

Empty tube monitoring parameters

Two parameters for setting the empty tube monitoring function are available:

- Empty Tube Detection
- Empty Tube Limit

The empty tube monitoring is activated via the Empty Tube Detection parameter. When the empty tube monitoring function is on, the massflow / volumeflow value is forced to zero if the tube is empty.

The tube is defined as empty, if the measured density value is lower than the value defined via the Empty Tube Limit parameter.

Note

Process media density

Risk of unintentionally forcing flow values to zero, if the difference between the empty tube limit density value and the density of the process media is not sufficient.

- Ensure sufficient difference between the empty tube limit density value and the process media density
-

8.5 Process noise damping

Noise damping function

The dynamic sensitivity of the flow measurement signal to rapid changes in process flows can be reduced by use of the process noise damping function. The function is typically used in environment with::

- Strongly pulsating flow
- Changing pump speeds
- Large pressure variations

Process noise damping settings

Reduce interfering process noise by increasing the setting of the parameter "Process Noise Damping".

- Centrifugal pump (minimum damping)
- Triplex pump
- Duplex pump
- Simplex pump
- Cam pump (maximum damping)

The default value is "Duplex pump". The damping affects all functions and outputs of the sensor.



Figure 8-1 Centrifugal pump

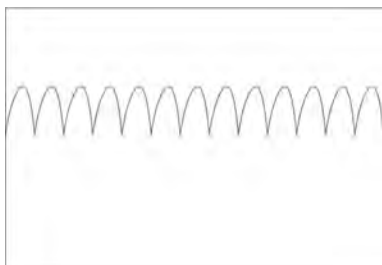

Figure 8-2 Triplex pump

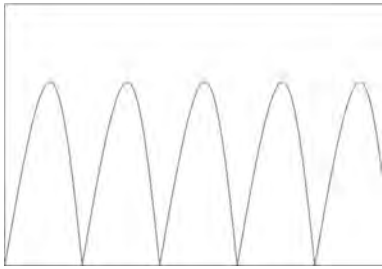

Figure 8-3 Duplex pump (default setting)

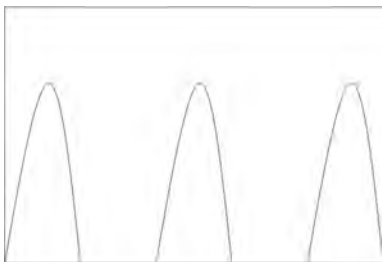

Figure 8-4 Simplex pump



Figure 8-5 Cam pump

Note

Increased reaction time

The reaction time of the sensor increases when the process noise is damped.

8.6 Inputs and outputs

The hardware functionality of input and output is fixed when ordering the product. The available configuration is described in the following table:

Channel	HW configuration (fixed when ordering)	SW configuration available to the user
1	Current output	Current (4-20 mA) HART
2	Signal output	<ul style="list-style-type: none"> • Current (0/4-20 mA) • Frequency or pulse • Three-stage analog valve dosing control • Discrete one or two-valve dosing control • Operational and alarm status
3	Signal output	<ul style="list-style-type: none"> • Current (0/4-20 mA) • Frequency or pulse • Redundant frequency or pulse • Three-stage analog valve dosing control • Discrete one or two-valve dosing control • Operational and alarm status
	Relay output	<ul style="list-style-type: none"> • Discrete one or two-valve dosing control • Operational and alarm status
	Signal input	<ul style="list-style-type: none"> • Dosing control • Totalizer reset • Remote zero adjust • Force or freeze output(s)
4	Signal output	<ul style="list-style-type: none"> • Current (0/4-20 mA) • Frequency or pulse • Three-stage analog valve dosing control • Discrete one or two-valve dosing control • Operational and alarm status
	Relay output	<ul style="list-style-type: none"> • Discrete one or two-valve dosing control • Operational and alarm status
	Signal input	<ul style="list-style-type: none"> • Dosing control • Totalizer reset • Remote zero adjust • Force or freeze output(s)

8.6.1 Current output

All four channels can be configured as current output. As the 4 to 20 mA output on channel 1 is Functional Safety approved (SIL 2 on hardware and SIL 3 on software), the configuration options for channel 1 are limited, see below.

Current output configuration

The following process values can be assigned to the current output:

- Massflow *
- Volumeflow *
- Corrected Volumeflow
- Density *
- Fluid Temperature
- Fraction A (Volumeflow or Massflow)
- Fraction B (Volumeflow or Massflow)
- Fraction A %
- Fraction B %

*: Only the marked process variables can be allocated to the 4 to 20 mA output on Channel 1. All process variables are available through HART and all of channels 2 to 4.

The accuracy specified for the analog output signal applies only within the range 4 to 20 mA. Lower limit (4 mA) and upper limit (20 mA) can be assigned to any specific flow values.

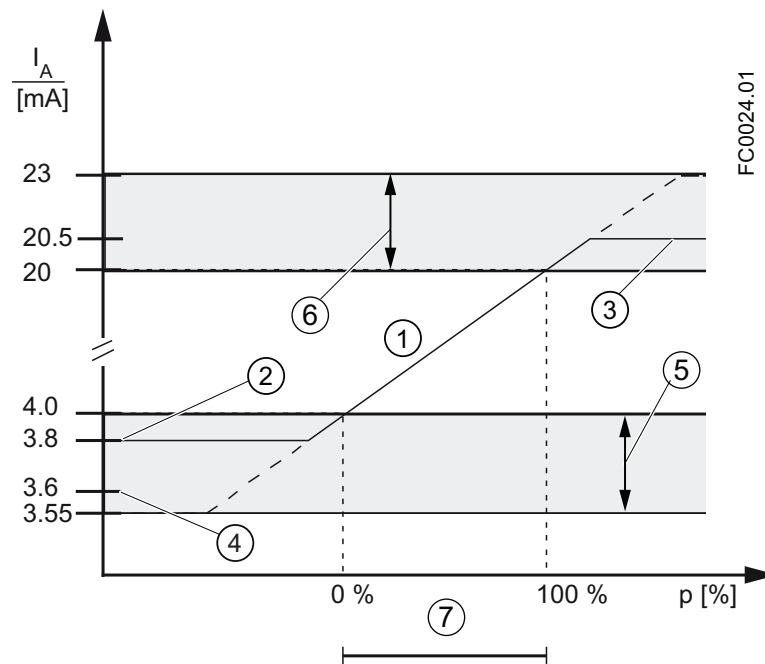

- ① Linear control range
- ② Measuring range lower limit
- ③ Measuring range upper limit
- ④ Lower fault current value
- ⑤ Recommended setting range for lower fault current
- ⑥ Recommended setting range for upper fault current
- ⑦ Measuring range

Figure 8-6 Current limits

The fail safe current output signal can be selected to:

- Minimum Current (defined in the Current Mode selection)
- Maximum Current (defined in the Current Mode selection)
- Last Good Value (the last process value before the failure occurred)
- Current Value (actual measured value)
- User Defined Value (within the range of 0 mA to 25 mA ¹⁾)

¹⁾ For channel 1 the range is 3.5 mA to 25 mA

Output scaling configuration

Below are four examples describing configuration possibilities for a current output.

Positive flow across zero with positive scaling

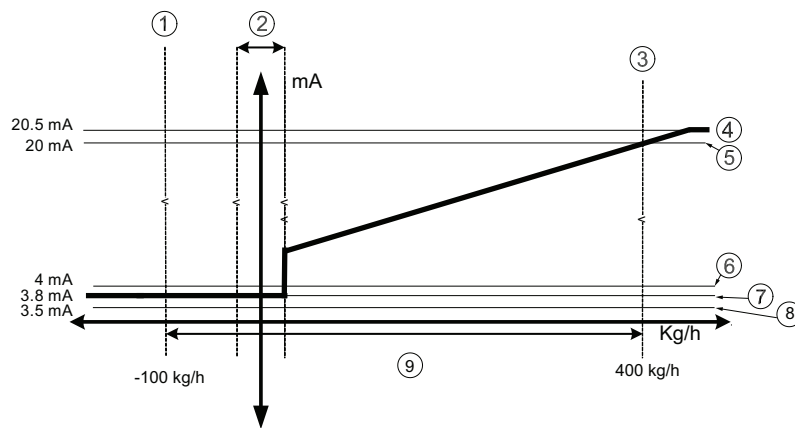

FC0015.01

- ① Lower scaling
- ② Low-flow cut-off
- ③ Upper scaling
- ④ Maximum measurement value
- ⑤ Upper range
- ⑥ Minimum measurement value
- ⑦ Lower range
- ⑧ Lower alarm value
- ⑨ Measurement range

Current output setting

- Process value = Massflow
- Direction = Positive
- Current Mode = 4-20 mA NAMUR
- Upper Scaling = 400 kg/h
- Lower Scaling = -100 kg/h
- Fail Safe Mode = Maximum current
- Low-Flow Cut-Off = 25 kg/h

Bidirectional flow across zero with positive scaling

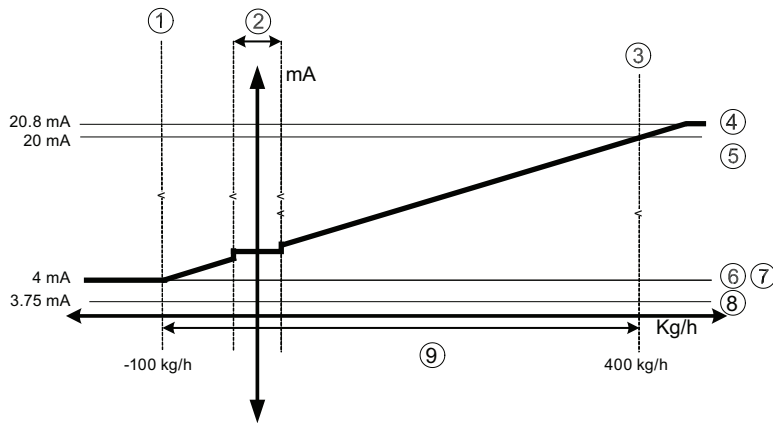

FC0014.01

- ① Lower scaling
- ② Low-flow cut-off
- ③ Upper scaling
- ④ Maximum measurement value
- ⑤ Upper range
- ⑥ Minimum measurement value
- ⑦ Lower range
- ⑧ Lower alarm value
- ⑨ Measurement range

Current output setting

- Process value = Massflow
- Direction = Positive
- Current Mode = 4-20 mA NAMUR
- Upper Scaling = 400 kg/h
- Lower Scaling = -100 kg/h
- Fail Safe Mode = Minimum current
- Low-Flow Cut-Off = 25 kg/h

Bidirectional flow with symmetrical scaling

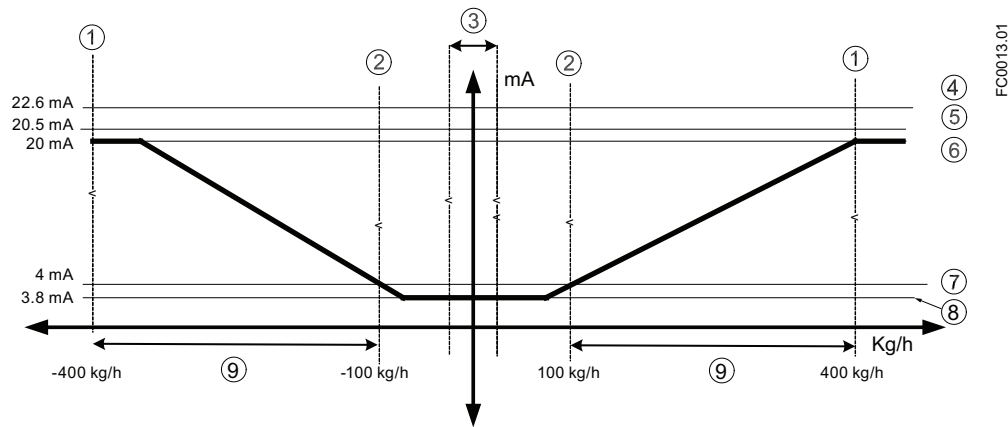

- ① Upper scaling
- ② Lower scaling
- ③ Low-flow cut-off
- ④ Upper alarm value
- ⑤ Maximum measurement value
- ⑥ Upper range
- ⑦ Minimum measurement value
- ⑧ Lower range
- ⑨ Measurement range

Current output setting

- Process value = Massflow
- Direction = Bidirectional (Symmetric)
- Current Mode = 4-20 mA NAMUR
- Upper Scaling = 400 kg/h
- Lower Scaling = 100 kg/h
- Fail Safe Mode = Maximum current
- Low-Flow Cut-Off = 25 kg/h

8.6.2 Pulse output

The pulse output function supplies pulses equivalent to a configured amount of accumulated volume or mass. The pulse width is configured and the pulse repetition is proportional to the selected flow rate.

Pulse repetition

Pulse repetition is calculated as follows:

$$\text{Pulse repetition} = \frac{\text{Amount per pulse}}{\text{Measured flow rate}}$$

FC0026.01

Note

Pulse width must be selected with the view that remaining time is always greater than pulse width at the highest measured flow.

Example

This example shows how a pulse repetition is calculated according to the pulse settings:

- Pulse output configuration (channels 2 to 4)
 - Operation Mode = Pulse Output
 - Process Value = Massflow
 - Amount Per Pulse = 1 kg
 - Pulse Width = 1 ms
- Measured massflow value = 10 kg/s (constant)

Result:

- Pulse repetition = 100 ms
- Output frequency = 10 pulses per second with a pulse width of 1 ms
- Remaining time between pulses is 99 ms

Redundancy mode

If both channel 2 and channel 3 are configured as pulse outputs, channel 3 can be configured for redundancy mode to follow channel 2 shifted by 90° or 180° of the functional width of the pulse. The functional width of the pulse is two times the pulse "On" duration. The flow direction will determine whether channel 3 is shifted before or after channel 2.

The following examples describe the pulse functionalities for channel 2 and 3 in redundancy mode:

Channel 2 configured as positive direction and channel 3 set to redundancy mode 90°

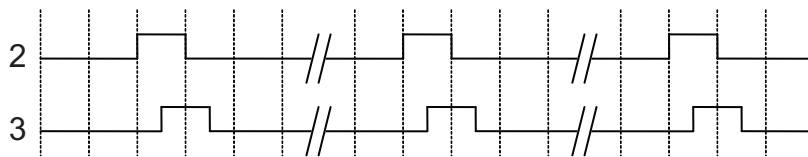

Figure 8-7 Positive flow - channel 3 lags by 90°

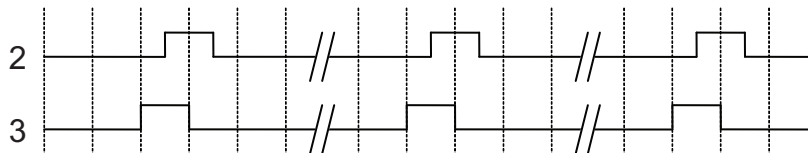

Figure 8-8 Negative flow - channel 3 leads by 90°

Channel 2 configured as positive direction and channel 3 set to redundancy mode 180°

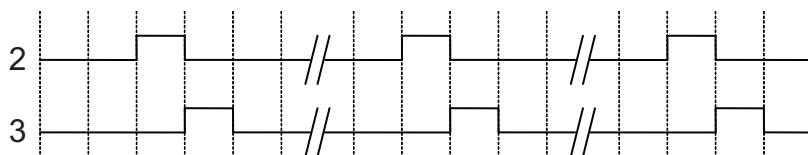

Figure 8-9 Positive flow - channel 3 lags by 180°

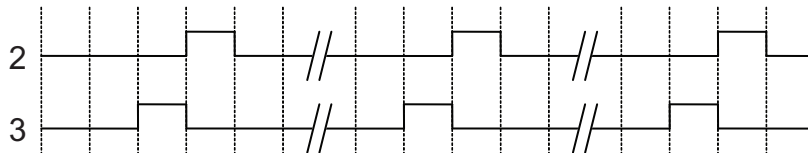

Figure 8-10 Negative flow - channel 3 leads by 180°

8.6.3 Frequency output

The frequency output function supplies a frequency (50% duty cycle) proportional to the selected process value.

Frequency is calculated as follows:

$$\text{Frequency} = \frac{\text{Measured massflow value}}{\text{Flow Value High} - \text{Flow Value Low}} \times (\text{Frequency Value High} - \text{Frequency Value Low})$$

FC0027.01

Example

This example shows how to calculate the output frequency for any measured flowrate:

Frequency output configuration:

- Operation Mode = Frequency Output (Channel 2 to 4)
- Process Value = Massflow
- Direction = Positive
- Frequency Value High = 12 kHz
- Frequency Value Low = 2 kHz
- Flow Value High = 15 kg/s
- Flow Value Low = 5 kg/s

Measured massflow value = 7.5 kg/s (constant)

Result:

- Frequency = 4.5 kHz

Note

The connected equipment must be capable of registering the full range of frequencies configured.

8.6.4 Status output

8.6.4.1 Alarm status

The alarm status can be signaled on Signal Output or Relay Output. Depending on the Alarm Mode setting, the alarms signaled on the output can be selected from alarm class or alarm item.

- Alarm Class: Alarm will be signaled if alarm within the selected alarm class occurs.
- Alarm Item: Alarm will be signaled if selected alarm item occurs.

Note

Alarm class can be either NAMUR or Standard (Siemens Standard) depending on Alarm Mode settings (ID 3.2.1). Both types of alarms and their messages are described in more detail in "Alarms and system messages" (Page 151).

8.6.5 Control output

The control output can be used for controlling discrete valve dosing and analog valve dosing as described in "Dosing" (Page 130).

8.6.6 Input

If the input is activated with a logic signal (15 - 30 V DC), the meter carries out an activity selected in the menu.

8.6.6.1 Input options

The following input options are available:

- Start dosing
- Hold / continue dosing
 - When this function is activated, it will pause the dosing. When it is deactivated, the dosing will continue
- Stop dosing
 - Sets the digital output to "Off" and resets the dosing counter
- Zero adjust
 - Starts the automatic zero point adjustment. This function employs the existing configurations and presumes that the process conditions are prepared for the zero point adjustment routine
- Reset totalizer
 - Resets one of the internal totalizers 1, 2 or 3 (depending on configuration)
- Resets all totalizers simultaneously

8.7 Totalizers

Totalizer functions

SITRANS FC430 has three independent totalizers that can be used for the summation of massflow, volumeflow, corrected volumeflow, fraction A (volumeflow or massflow) or fraction B (volumeflow or massflow).

The totalizers can be configured to count balance (net flow), positive flow or negative flow.

In case of failure in the system, the totalizer fail safe mode can be set to:

- Hold: the totalizer holds the last value before the failure occurred
- Run: the totalizer continues counting the actual measured value
- Memory: the totalizer continues counting based on the last input value (for example massflow) before the failure occurred.

The totalizers can be operated via the Local User Interface or HART (for example SIMATIC PDM). The totalizers can be reset or preset.

8.8 Dosing

The dosing function controls the sequence of flow through one or two valves into a container. The user can set the Amount and the sequence of controlling the valve(s). The dosing function then controls the valves to open and close in sequence to achieve the Amount.

The process values for dosing control are updated with 100 Hz to ensure maximum response time of 10 ms to rapidly changing flows.

The flow sequence can be paused, resumed and ended by the user at any point in the flow sequence.

Transmitter outputs therefore change state according to the dosing sequence or operator commands. For optimal dosing control the minimum number of components between the flowmeter and the dosing valves must be employed. The dosing function must be configured for the type of valve used for dosing:

- One Stage Dosing:
Dosing controlled by a single discrete (Open/Closed) valve. The valve opens completely when the dosing begins, and closes completely when the dosing Amount is reached.
- Two Stage Dosing:
Dosing controlled by two discrete valves (a primary valve and a secondary valve). One valve opens at the beginning of the dosing; the other opens at a user-defined amount. One valve stays open until the end of the dosing; the other closes at a user-defined amount. See examples below (Page 131) of some different opening and closing options.
- Analog Dosing:
Dosing controlled by an analog valve configured in three stages as fully open, partially closed, and fully closed. See example below (Page 131) of the three-positional analog dosing.

Dosing configuration

The dosing functionality is configured via LUI. Menu 2.4 "Inputs/Outputs" determines how the transmitter will use the inputs and outputs for dosing control. Menu 2.5 "Dosing" independently determines the sequencing of the outputs to achieve the user's desired result.

The dosing function provides:

- three dosing valve control mechanisms (One Stage Dosing, Two Stage Dosing or Analog Dosing)
- dosing of massflow, volumeflow, corrected volumeflow or fraction flow (mass or volume)
- five independently configurable recipes
- flexible discrete or analog valve control
- fault handling – time and amount monitoring

Configure the dosing function as follows:

1. Basic dosing parameters common for all recipes in menu 2.5 "Dosing"
 - Select valve control functionality at parameter "Dosing Mode"
 - Select measured process value for dosing at parameter "Process Values"
2. Individual recipe(s) in menus 2.5.4 to 2.5.8 as required
 - Setup dosing name, amount, unit and compensation
 - Select valve control sequence
 - Select fault handling configuration
3. Output(s) in menu 2.4 "Inputs/Outputs" (see table below).
4. Input for dosing control in menu 2.4 "Inputs/Outputs"

8.8.1 Valve control configuration

Valve control dosing

Dosing is controlled with either one or two discrete valves or a single analog valve. The transmitter provides up to three input/output channels which can be used for dosing control. The selection of channels is fixed when ordering the system. The channels can be setup for dosing functionality in parameter 2.5.1 "Dosing Mode" as shown in the table below. Allocation of the output to a specific dosing sequence element is performed in the software configuration as follows:

One stage dosing

Configuration of one valve (primary valve).

One of the following channels must be assigned to control the discrete primary valve.

Table 8-1 One Stage Dosing

Valve control	Channel HW configuration	Output channel	Channel SW configuration		
			Menu item		Value
Discrete valve control - Primary Valve	Signal output	2	2.4.2.1	"Operating Mode"	Status Output
			2.4.2.26	"Status Mode"	Primary Valve Dosing
		3	2.4.3.1	"Operating Mode"	Status Output

Functions

8.8 Dosing

Valve control	Channel HW configuration	Output channel	Channel SW configuration		
			Menu item		Value
		4	2.4.3.28	"Status Mode"	Primary Valve Dosing
			2.4.6.1	"Operating Mode"	Status Output
			2.4.6.26	"Status Mode"	Primary Valve Dosing
	Relay output	3	2.4.4.1	"Status Mode"	Primary Valve Dosing
		4	2.4.7.2	"Status Mode"	Primary Valve Dosing

Two stage dosing

Configuration of two valves (primary and secondary valves)

One of the following channels must be assigned to control the discrete primary valve and one must be assigned to control the secondary discrete valve.

Table 8-2 Two Stage Dosing

Valve control	Channel HW configuration	Output channel	Channel SW configuration		
			Menu item		Value
Discrete valve control - Primary Valve	Signal output	2	2.4.2.1	"Operating Mode"	Status Output
			2.4.2.26	"Status Mode"	Primary Valve Dosing
		3	2.4.3.1	"Operating Mode"	Status Output
			2.4.3.28	"Status Mode"	Primary Valve Dosing
		4	2.4.6.1	"Operating Mode"	Status Output
			2.4.6.26	"Status Mode"	Primary Valve Dosing
	Relay output	3	2.4.4.1	"Status Mode"	Primary Valve Dosing
		4	2.4.7.2	"Status Mode"	Primary Valve Dosing
Discrete valve control - Secondary Valve	Signal output	2	2.4.2.1	"Operating Mode"	Status Output
			2.4.2.26	"Status Mode"	Secondary Valve Dosing
		3	2.4.3.1	"Operating Mode"	Status Output
			2.4.3.28	"Status Mode"	Secondary Valve Dosing
		4	2.4.6.1	"Operating Mode"	Status Output
			2.4.6.26	"Status Mode"	Secondary Valve Dosing
	Relay output	3	2.4.4.1	"Status Mode"	Secondary Valve Dosing
		4	2.4.7.2	"Status Mode"	Secondary Valve Dosing

Analog Dosing

Configuration of one analog valve.

One of the following channels must be assigned to control the analog valve.

Table 8-3 Analog Dosing

Dosing mode	Valve control	Channel HW configuration	Output channel	Channel SW configuration		
				Menu item	Value	
Analog Dosing	Analog	Signal output	2	2.4.2.1	"Operating Mode"	Current Output
				2.4.2.2	"Process Value"	Analog Dosing
			3	2.4.3.1	"Operating Mode"	Current Output
				2.4.3.2	"Process Value"	Analog Dosing
			4	2.4.6.1	"Operating Mode"	Current Output
				2.4.6.2	"Process Value"	Analog Dosing

Note

If the output channels including current output are configured for valve control, they cannot report alarm status or fault levels.

Table 8-4 Parameter settings for Two Stage Dosing valve control

Valve control parameter configured in each recipe	Default values	Description
Stage 1 Primary Open	0.00 % of Amount	The quantity or percent of the Amount at which the primary valve will open
Stage 1 Primary Close	80.00 % of Amount	The quantity or percent of the Amount at which the primary valve will close
Stage 2 Secondary Open	20.00 % of Amount	The quantity or percent of the Amount at which the secondary valve will open
Stage 2 Secondary Close	100.00 % of Amount	The quantity or percent of the Amount at which the secondary valve will close

Either Stage 1 Primary Open or Stage 2 Secondary Open must be set to 0. For controlling the valves via the outputs, two of channels 2, 3 and 4 must be assigned to Primary Valve Dosing Control and Secondary Valve Dosing control, respectively.

Either Stage 1 Primary Close or Stage 2 Secondary Close must be set to Amount.

In the examples below the primary valve, the secondary valve, and the flow is indicated as follows:

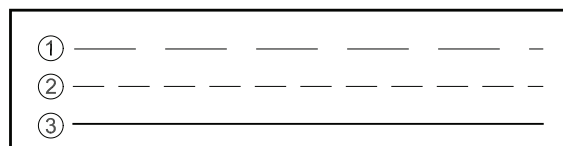

FC0023.01

- ① Primary valve
- ② Secondary valve
- ③ Flow

Examples of valve control configuration

Open primary valve at 0 %; close primary valve before closing secondary valve configured in recipe 1

Parameter configuration:

Menu 2.5 Dosing

- 2.5.1 Dosing Mode = Two Stage Dosing

Menu 2.5.4.5 Valve Control

- 2.5.4.5.1 Stage Setup Format = Relative

- 2.5.4.5.2 Stage 1 Primary Open = 0 %

- 2.5.4.5.3 Stage 1 Primary Close = 66 %

- 2.5.4.5.4 Stage 2 Secondary Open = 33 %

- 2.5.4.5.5 Stage 2 Secondary Close = 100 %

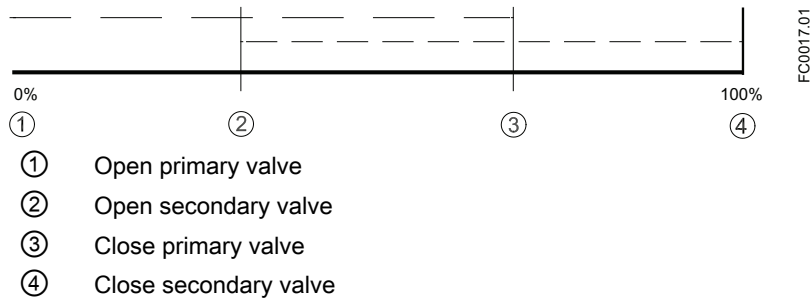

Open primary valve at 0 %; close primary valve after closing secondary valve configured in recipe 1

Parameter configuration:

Menu 2.5 Dosing

- 2.5.1 Dosing Mode = Two Stage Dosing

Menu 2.5.4.5 Valve Control

- 2.5.4.5.1 Stage Setup Format = Relative

- 2.5.4.5.2 Stage 1 Primary Open = 0 %

- 2.5.4.5.3 Stage 1 Primary Close = 100 %

- 2.5.4.5.4 Stage 2 Secondary Open = 33 %

- 2.5.4.5.5 Stage 2 Secondary Close = 66 %

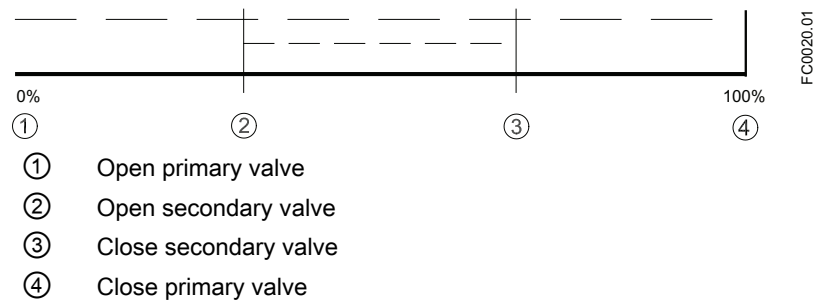

Open secondary valve at 0 %; close primary valve before closing secondary valve configured in recipe 1

Example 3: Open secondary valve at 0%.; close primary valve before closing secondary valve – configured in recipe 1.

Parameter configuration:

Menu 2.5 Dosing

- 2.5.1 Dosing Mode = Two Stage Dosing

Menu 2.5.4.5 Valve Control

- 2.5.4.5.1 Stage Setup Format = Relative

- 2.5.4.5.2 Stage 1 Primary Open = 33 %

- 2.5.4.5.3 Stage 1 Primary Close = 66 %

- 2.5.4.5.4 Stage 2 Secondary Open = 0 %

- 2.5.4.5.5 Stage 2 Secondary Close = 100 %

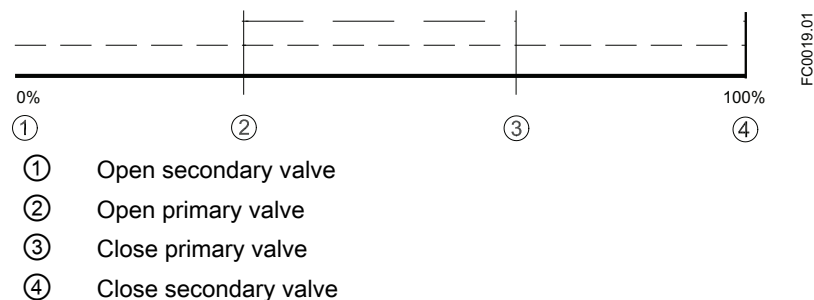

Open secondary valve at 0 %; close primary valve after closing secondary valve configured in recipe 1

Example 4: Open secondary valve at 0%.; close primary valve after closing secondary valve – configured in recipe 1.

Parameter configuration:

Menu 2.5 Dosing

- 2.5.1 Dosing Mode = Two Stage Dosing

Menu 2.5.4.5 Valve Control

- 2.5.4.5.1 Stage Setup Format = Relative
- 2.5.4.5.2 Stage 1 Primary Open = 33 %
- 2.5.4.5.3 Stage 1 Primary Close = 100 %
- 2.5.4.5.4 Stage 2 Secondary Open = 0 %
- 2.5.4.5.5 Stage 2 Secondary Close = 66 %

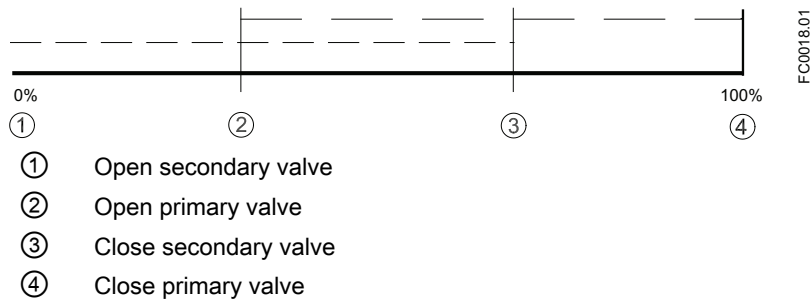

- Analog Dosing:
 Dosing controlled by an analog valve configured in three stages as fully open (high flow), partially open, and fully closed. During the open stage the valve may be not fully open but controlled to a high flow condition.

Valve control parameter configured in each recipe	Default value	Description
Fully Closed Current Level	0 mA	The output current which defines the closed valve state
Partial Open Current Level	10 mA	The output current which defines the partially open valve state
Fully Open Current Level	20 mA	The output current which defines the high flow valve state
Fully Open	0.00 % of Amount	The quantity or percent of amount at which the valve will transition from partial to full flow
Partially Closed	100.00 % of Amount	The quantity or percent of amount at which the valve will transition from full flow to partial flow

Three-positional analog dosing configured in recipe 1

- Parameter configuration:
- Menu 2.5 Dosing
- 2.5.1 Dosing Mode = Analog Dosing
- Menu 2.5.4.5 Valve Control
- 2.5.4.5.1 Stage Setup Format = Relative
- 2.5.4.5.6 Fully Closed Current Level = 0 mA
- 2.5.4.5.7 Partial Open Current Level = 10 mA
- 2.5.4.5.8 Fully Open Current Level = 20 mA
- 2.5.4.5.9 Fully Open = 35 %

2.5.4.5.10 Partially Closed = 65 %

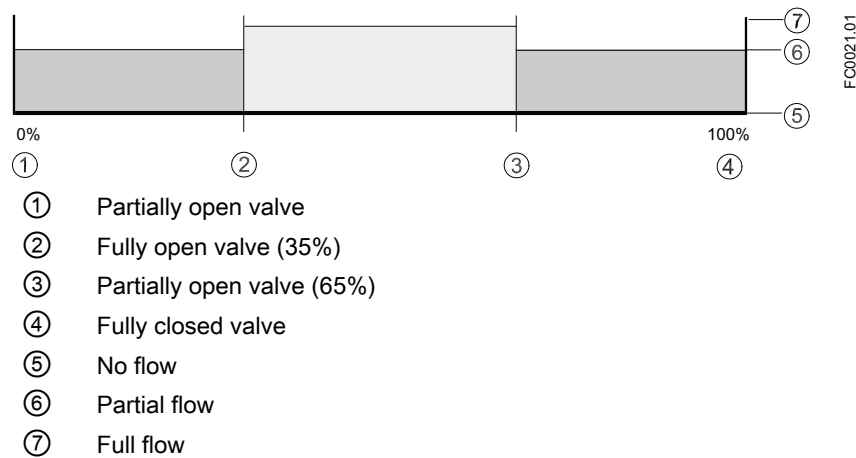

8.8.2 Dosing operation

When the transmitter recipes have been configured, the active recipe is selected in parameter 2.5.3 "Active Recipe". The transmitter output changes according to the dosing operation and controls the valve in the dosing process. The digital input can be configured to start dosing. LUI provides dosing control via menu 3.10.1 Control Dosing for test purpose. All dosing setup and control can be performed via HART interface using SIMATIC PDM.

8.8.3 Fault handling

The transmitter fault handling provides monitoring of both dosing time and amount. The configuration of the fault handling is done in menu 2.5.4.6 Fault Handling.

Dosing timeout monitoring

The dosing timeout monitoring checks whether the dosing procedure has been finished within the configured Duration Time (menu item 2.5.4.6.2). If the duration time is exceeded, an alarm will be triggered, see "Alarms and system messages" (Page 151).

Dosing overrun monitoring

The dosing overrun monitoring checks if the flow amount exceeds the defined Overrun Value (menu item 2.5.4.6.4). If the overrun value is exceeded, an alarm will be triggered, see "Alarms and system messages" (Page 151).

This function can detect a valve malfunction (non-closure) caused by a blockage, wear, etc.

8.9 SensorFlash

SensorFlash is a standard, micro SD card (1 GB) with the ability to be updated by PC. It is supplied with each sensor with the complete set of certification documents including calibration report. Material, pressure test, factory conformance and O₂ cleaning certificates are optional at ordering.

The Siemens SensorFlash memory unit offers the following features and benefits:

- Automatically program any similar transmitter in seconds to the operation standard
- Transmitter replacement in less than 5 minutes
- True "plug & play" provided by integrated cross-checking data consistency and HW/SW version verification
- Permanent database of operational and functional information from the moment that the flowmeter is switched on
- New firmware updates can be downloaded from the Siemens internet portal for Product Support and stored on SensorFlash (unmounted from the transmitter and inserted into a PC's SD card slot). The firmware is then loaded from the SensorFlash into the existing flowmeter and the complete system upgraded

8.10 Simulation

Simulation is used for testing purposes, typically for checking that the readings of the control system are correct.

The simulation can be activated in LUI (menu item 3.7) or via SIMATIC PDM in the parameter "Enable Simulation" (EnableSimulation).

Inputs/output simulation

Depending on the configuration of each input/output the following values can be simulated:

Table 8-5 Inputs/outputs simulation

HW configuration	Channel 1	Channel 2	Channel 3	Channel 4	Simulation value
Current output	•				4 to 20 mA
Relay output			•	•	0 (low) or 1 (high)
Signal input			•	•	0 (low) or 1 (high)
Signal output		•	•	•	<ul style="list-style-type: none"> • 0 to 25 mA • 0 to 12.5 kHz • 0 to 12.5 kHz • 0 (low) or 1 (high)

Process value simulation

The following process values can be simulated:

- Massflow
- Volumeflow
- Corrected Volumeflow
- Density
- Process Media Temperature
- Fraction A %
- Fraction B %

Enabling simulation for the process values sets the simulated value for all outputs.

Alarm simulation

In PDM it is possible to simulate either specific alarms (ID numbers) or alarm classes; in LUI only alarm classes can be simulated. The alarm classes are either Siemens or NAMUR depending on the configuration of Alarm Mode, menu item 3.2.1.

All alarms mentioned in "Alarm messages" (Page 153) can be simulated.

8.11 Maintenance

- **Set Date and Time**
The device has a built-in real-time clock used for time stamps of various events (for example alarms and configuration changes). The date and time can be set in menu item 3.3.2.
- **Set To Default**
The device can be reset to its default settings in menu item 3.3.3.
- **Restart Device**
The device can be restarted without disconnecting the power in menu item 3.3.4.

Custody Transfer

9.1 Introduction

The SITRANS FC430 flowmeter is suitable for custody transfer measurement for liquids other than water according to OIML R 117-1 with accuracy class 0.3.

Note**Ordering**

Only flowmeters with local user interface (LUI) ordered with Z-option "B31" (Custody Transfer) can be set to this mode.

When "B31" is specified, the transmitter specification nameplate shows "SW Function" as "CT standard".

Available versions:

- Standard: 7ME4613-XXXXX-XXX3-Z AXX+B31+EXX+FXX
 - Hygienic: 7ME4623-XXXXX-XXX3-Z AXX+B31+EXX+FXX
 - NAMUR: 7ME4713-XXXXX-XXX3-Z AXX+B31+EXX+FXX
-

9.2 Operating conditions

The operating conditions stated in the evaluation certificate may be reduced compared to the operating conditions stated on the product nameplates. A copy of the certificate is included on the SensorFlash and can be downloaded from www.siemens.com/FC430 (www.siemens.com/FC430).

Note**Operating conditions**

Only the operating conditions stated in the evaluation certificate are valid.

For identification of custody transfer evaluated devices, see "Device identification" (Page 17).

9.3 Verification

Custody transfer requirements

All custody transfer devices are verified on site using reference measurements.

The device may only be used for applications subject to legal metrology once it has been verified on site by the Verification Authority. The associated seals on the device ensure this status.

NOTICE
Verification requirements
All flowmeters used for invoicing in applications subject to legal metrology controls must be verified by the Verification Authorities. The corresponding approvals and the country-specific requirements and regulations must be observed. The owner / user of the instrument is obliged to conduct and maintain subsequent verifications.

Verification process

The following description of the process for securing custody transfer operation of the flowmeter is general in nature and provided only for setup of the flowmeter in a separately approved flow application. Following these instructions alone does not constitute approved custody transfer operation. Refer to the relevant local authorities for requirements regarding custody transfer operation.

9.4 Setting up custody transfer mode

The device has to be operational and not yet set to custody transfer mode.

1. Configure the functions important for custody transfer measurement, such as the output setup (pulse, frequency), custody transfer variable and the measuring mode.
2. Once all the functions relevant to custody transfer have been configured, open the front lid and remove the LUI display module to access the CT DIP switch group. The flowmeter is set to custody transfer mode by setting the DIP switch (4) in "ON" position as shown in the figure below.

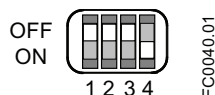
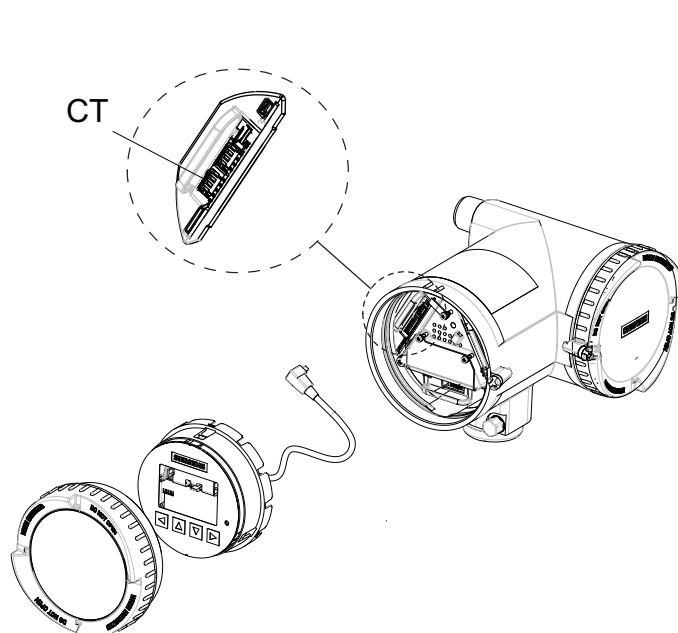

Figure 9-1 CT switch (4) "ON"

Note

Protected parameters

Parameters protected in CT mode are listed in "Parameter protection in custody transfer mode" (Page 146).



3. Remove lid lock screw of display lid.
4. Remove display lid.
5. Carefully pull out local display.
6. Set DIP switch to CT mode.
7. Carefully push display back into housing.
8. Remove o-ring from lid.

9.4 Setting up custody transfer mode

- 9. Reinstate display lid until mechanical stop. Wind back lid by one turn.
- 10. Mount o-ring by pulling it over the display lid and wind the lid in until you feel friction from the o-ring on both sides. Wind display lid by one quarter of a turn to seal on the o-ring.
- 11. Reinstate and tighten lid lock screw.

Sealing the flowmeter for CT operation

Seal device as shown in figures below. The seal should be crimped by the Approving Authority and may bear their mark.

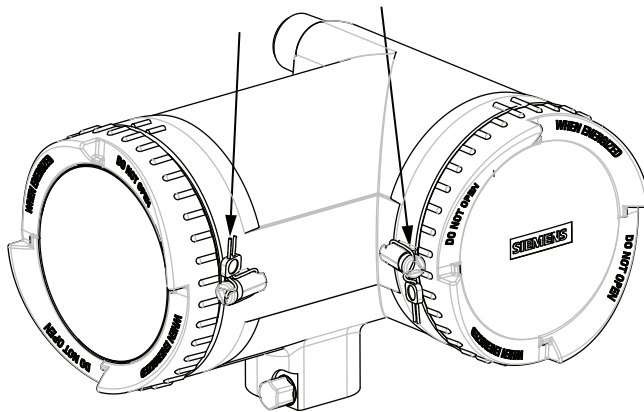

Figure 9-2 Transmitter seals in place - compact version. Arrows indicate the seal points of the two lock screws

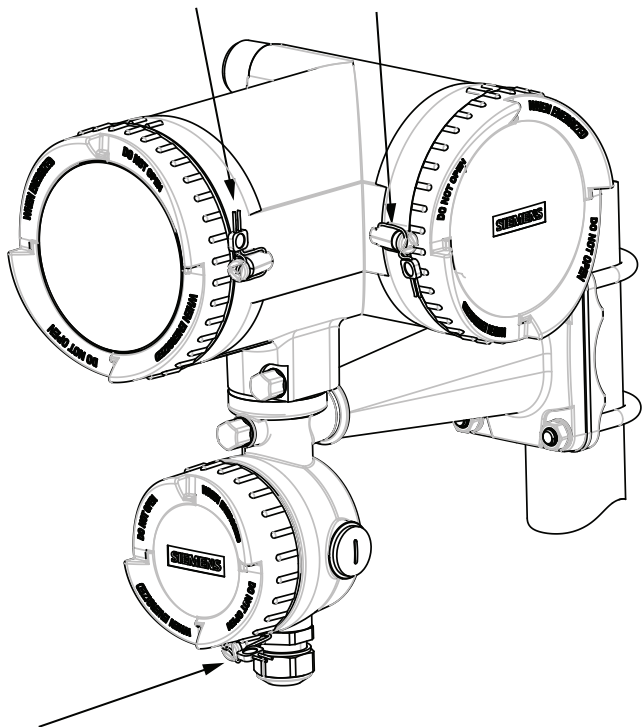

Figure 9-3 Remote transmitter seals in place - termination variant. Arrows indicate the seal points of the three lock screws. The lock screw of the DSL must also be sealed

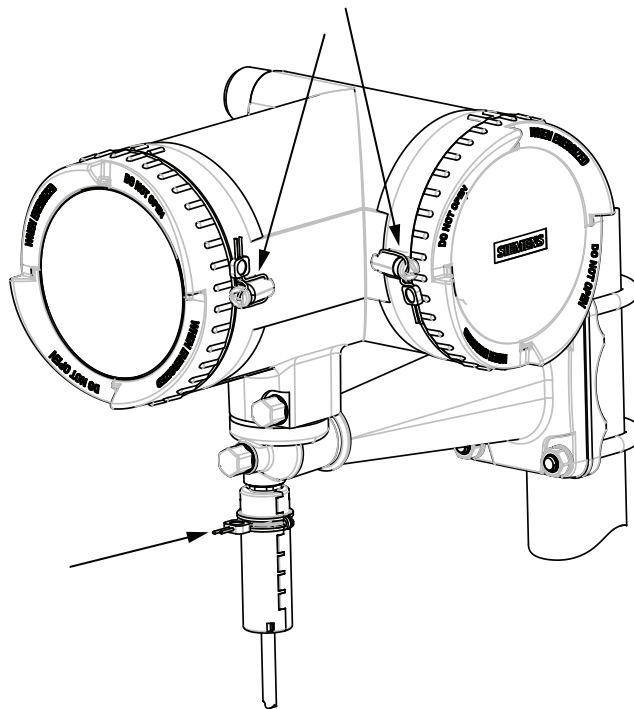

Figure 9-4 Remote transmitter seals in place - M12 plug variant. Arrows indicate the seal points of the two lock screws and cable sealing

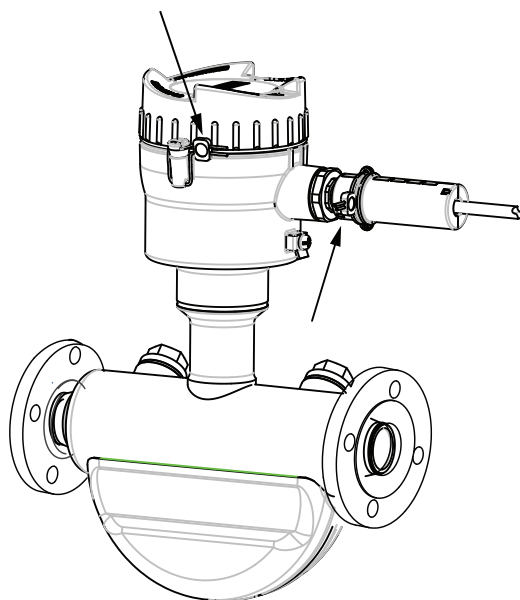

Figure 9-5 Remote sensor seals in place - M12 variant. Arrows indicate the seal points of the lock screw and cable sealing

9.5 Parameter protection in custody transfer mode

For remote variants with M12 plugs it is necessary to use the plug seals supplied with the flow sensor. The plug seal encases the M12 plug, preventing unauthorized removal of the sensor cable at either end.

The M12 plug is sealed in the following manner:

1. Make sure the M12 plug is correctly installed and tight in its socket.
2. Clip the two halves of the plug seal together around the plug and sensor cable as shown in the above figures.
3. Ensure that the plug seal is free to rotate without catching on the plug or cable. The seal assembly prevents unauthorized access by disabling any ability to unscrew the plug from its socket.
4. Close the seal with a seal wire and crimp the seal plumb.

The device is now prepared for custody transfer operation and may be used in applications subject to legal metrology controls.

9.5 Parameter protection in custody transfer mode

The CT mode provides an additional protection of set of parameters. These parameters are writable in non-CT mode but only readable in CT mode. In the following table the menus are entered in **bold** text and the parameters in *italic*.

For a complete list of parameters, see appendix "LUI menu structure" (Page 203).

Table 9-1 Parameters protected in CT mode

Level 2		Level 3		Level 4		Level 5			
No.	Name	No.	Name	No.	Name	No.	Name		
2.1	Basic settings	2.1.1	<i>Flow Direction</i>						
		2.1.2	<i>Process Noise Damping</i>						
2.2	Process Values	2.2.1	Massflow	2.2.1.2	<i>Low Flow Cut-Off</i>				
		2.2.2	Volumeflow	2.2.2.2	<i>Low Flow Cut-Off</i>				
		2.2.3	Corrected Volumeflow	2.2.3.7.	Reference Density	2.2.3.7.2	<i>Corrected Volumeflow Mode</i>		
						2.2.3.7.3	<i>Fixed Reference Density</i>		
						2.2.3.7.4	<i>Linear Expansion Coeff.</i>		
						2.2.3.7.5	<i>Square Expansion Coeff.</i>		
						2.2.3.7.6	<i>Reference Temperature</i>		
		2.2.4	Flow Adjustment	2.2.4.1	<i>Adjustment Factor</i>				
2.2.5	Density	2.2.5.2	<i>Empty Tube Detection</i>						
		2.2.5.3	<i>Empty Tube Limit</i>						

9.5 Parameter protection in custody transfer mode

Level 2		Level 3		Level 4		Level 5	
No.	Name	No.	Name	No.	Name	No.	Name
				2.2.5.9	Density Adjustment	2.2.5.9.1	Adjustment Factor
						2.2.5.9.2	Adjustment Offset
		2.2.7	Fraction	2.2.7.1	Measurement Mode		
				2.2.7.3	Fraction A	2.2.7.3.1	Fraction A Text
				2.2.7.4	Fraction A	2.2.7.4.1	Fraction B Text
				2.2.7.7	Fraction Adjustment	2.2.7.7.1	Fraction Factor
						2.2.7.7.2	Fraction Factor
2.3	Totalizer	2.3.1	Totalizer 1	2.3.1.1	Process Values		
				2.3.1.2	Unit		
				2.3.1.3	Direction		
				2.3.1.4	Fail Safe Mode		
				2.3.1.10	Reset		
		2.3.2	Totalizer 2	2.3.2.1	Process Values		
				2.3.2.2	Unit		
				2.3.2.3	Direction		
				2.3.2.4	Fail Safe Mode		
				2.3.2.10	Reset		
		2.3.3	Totalizer 3	2.3.3.1	Process Values		
				2.3.3.3	Direction		
				2.3.3.4	Fail Safe Mode		
				2.3.3.10	Reset		
2.3.4	Reset all totalizers						
2.4	Inputs/Outputs	2.4.2	Signal Output (2)	All parameters			
		2.4.3	Signal Output (3)	All parameters			
		2.4.4	Relay Output (3)	All parameters			
		2.4.5	Signal Input (3)	All parameters			
		2.4.6	Signal Output (4)	All parameters			
		2.4.7	Relay Output (4)	All parameters			
		2.4.8	Signal Input (4)	All parameters			
2.6	Zero point adjustment	2.6.1	Select Zero Point Adj.				
		2.6.2	Start Zero Point Adj.				
		2.6.3	Duration				
		2.6.4	Standard Deviation Limit				
		2.6.6	Offset Limit				
		2.6.8	Offset				
3.3	Maintenance	3.3.4	Restart Device				
3.7	Simulation	3.7.2	Simulation Process Values	3.7.2.1	Massflow	3.7.2.1.1	Simulation
						3.7.2.1.2	Massflow Value
		3.7.2.2	Volume flow	3.7.2.2.1	Simulation		

9.6 Disabling custody transfer mode

Level 2		Level 3		Level 4		Level 5	
No.	Name	No.	Name	No.	Name	No.	Name
						3.7.2.2.2	Volumeflow Value
				3.7.2.3	Corrected Volumeflow	3.7.2.3.1	Simulation
						3.7.2.3.2	Corrected Volumeflow Value
				3.7.2.4	Density	3.7.2.4.1	Simulation
						3.7.2.4.2	Density Value
				3.7.2.5	Fluid Temperature	3.7.2.5.1	Simulation
						3.7.2.5.2	Fluid Temperature Value
				3.7.2.6	Frame Temperature	3.7.2.6.1	Simulation
						3.7.2.6.1	Frame Temperature Value
				3.7.2.7	Fraction	3.7.2.7.1	Simulation
						3.7.2.7.2	Fraction A % Value
						3.7.2.7.3	Fraction B % Value

Note

Reset of totalizers

The reset functions (totalizer 1, totalizer 2, and all totalizers) are not available in CT mode.

9.6 Disabling custody transfer mode

The device has to be operational and already set to custody transfer mode.

1. Remove the custody transfer seals.

 WARNING
Explosion-protected equipment If handling explosion-protected equipment, observe a cooling or discharge time of 10 minutes before opening the device.

2. Remove lid lock screw of display lid.
3. Remove display lid.
4. Carefully pull out local display.

- Set DIP switch (4) in "OFF" position to enable operation in non-CT mode.

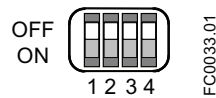

Figure 9-6 CT switch (4) "OFF"

- Carefully push display back into housing.
- Remove o-ring from lid.
- Reinstate display lid until mechanical stop. Wind back lid by one turn.
- Mount o-ring by pulling it over the display lid and wind lid in until you feel friction from the o-ring on both sides. Wind the lid further by one quarter of a turn to seal on the o-ring.
- Reinstate and tighten lid lock screw. Do not install seals on the lid lock screws.

Alarms and system messages

10.1 Overview of messages and symbols

This section describes alarm messages shown on the LUI display.

Display behavior on local user interface

Messages are shown in the operation view of the display. The operating view can be configured to show measurement view or alarm list view.

- Measurement view shows the alarms as a combination of symbol and text in the lower line of the display. If several diagnostic messages are active at the same time, the one shown is always the most critical.
- Alarm list view shows all active alarms on a list. The alarm list combines a symbol, text and an alarm ID number. The most recent alarm is shown on top of the list. The alarm list view can also be accessed via menu item 3.3.2 Alarm.
- Alarm history view lists the most recent alarms (up to 100). The alarm history log can be viewed in menu item 3.2.3. The alarm history log can be reset in menu item 3.2.4.

Alarms list view

In the primary alarm list view the active alarms are listed. Press  to access the secondary alarm list view.

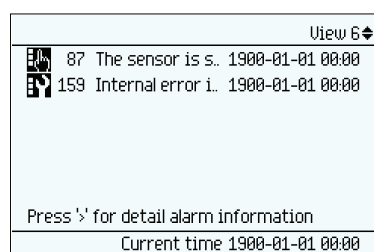





Figure 10-1 Primary alarm list view

In the secondary alarm list view it is possible to select any of the active alarms. Press  or  to scroll through the alarm list. Press  to access detailed information of the highlighted alarm.

10.1 Overview of messages and symbols

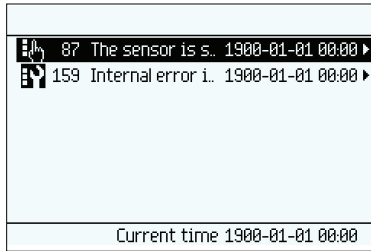

Figure 10-2 Secondary alarm list view

In the detailed alarm information view the diagnostic and action texts are displayed.

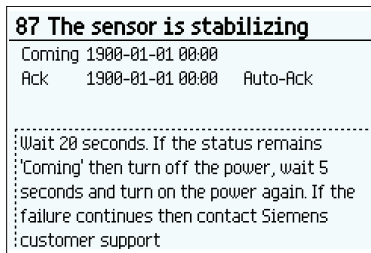

Figure 10-3 Detailed alarm information view

Press to exit the detailed information view.

Characteristics of messages

The device provides two types of alarm classes, NAMUR and Siemens standard, selected in menu item 3.2.1 Alarm Mode.

The following tables summarize the two types of alarm classes in an overview.



The sequence of the symbols corresponds to the priority of the messages, beginning with the most critical.

Siemens standard alarm classes

The number of dots assigned to the symbol defines the importance level of the message.



Table 10-1 Siemens standard icons

Icon	Alarm class	Definition
	Maintenance alarm	The device outputs fault current. Service the device immediately.
	Process value alarm	The device outputs a fault current or is at the limit of the saturation range.

	Process value warning	There is a problem with one or more process values. Thus the device is still measuring process values, but these may be unreliable. Example: A process value exceeds the device specification.
	Function check	Output signal temporarily invalid (for example frozen) due to on-going work on the device.

NAMUR alarm classes

Table 10-2 NAMUR icons



Icon	Alarm classes	Definition
	Failure	Output signal invalid due to malfunction in the field device or its peripherals.
	Out of Specification	"Off-spec" means that the device is operating outside its specified range (for example measuring or temperature range) or that internal diagnoses indicate deviations from measured or set values due to internal problems in the device or process characteristics (for example compressible emulsions in the process medium).
	Function check	Output signal temporarily invalid (for example frozen) due to on-going work on the device.

10.2 Alarm messages

Alarms and system messages support both Siemens standard and NAMUR.

In the following tables icons indicating the alarm class and alarm ID (identification number) can be found along with possible causes and directions for corrective action.

Table 10-3 Alarm classes Maintenance alarm (Siemens standard), Failure (NAMUR)

Siemens	NAMUR	ID	Diagnostic	Action
				
		36 37	Too high voltage detected at power supply	Ensure correct power supply quality. Maximum power is 264 V AC and 100 V DC
		38 39 40 41	Temperature measurement fault	Turn off the power, wait 5 seconds and turn on the power again. If the failure continues then contact Siemens customer support
		46	Invalid calibration data	Contact Siemens customer support for recalibration
		47	Invalid compensation data	Contact Siemens customer support for recalibration
		49 50 51	Malfunction in pickup amplitude	Contact Siemens customer support for recalibration

Alarms and system messages

10.2 Alarm messages





Siemens 	NAMUR 	ID	Diagnostic	Action
		55 56 57 58	Malfunction in sensor driver	Contact Siemens customer support
		71	Parameter storage malfunction	Turn off the power, wait 5 seconds and turn on the power again. If the failure continues then contact Siemens customer support
		72 73 74 75 76 77	Internal error in sensor	Contact Siemens customer support
		150	Sensor signal disrupted	Turn off the power. Unplug and reconnect the sensor cable. Restore power. If the failure continues, contact Siemens customer support
		159	Internal error in transmitter	Turn off the power, wait 5 seconds and turn on the power again. If the failure continues, contact Siemens customer support
		194	Invalid process value during dosing	Check installation for abnormal operating conditions. If the failure continues for several dosings, contact Siemens customer support
		197	Current output cable break	Check channel 2 current output cable connection
		203	Current output cable break	Check channel 3 current output cable connection
		209	Current output cable break	Check channel 4 current output cable connection

Table 10-4 Alarm classes Process value alarm (Siemens standard), Off-specification (NAMUR)

Siemens 	NAMUR 	ID	Diagnostic	Action
		42 43 44 45	Flow values not valid	Can be due to problems with measured fluid or hardware malfunction. If the failure continues then contact Siemens customer support
		59	Massflow out of specification	Reduce the flow. If the failure continues then contact Siemens customer support
		60	Volumeflow out of specification	Reduce the flow. If the failure continues then contact Siemens customer support
		61	Density out of specification	Contact Siemens customer support
		62	Fluid temp. out of specification	Increase the fluid temperature. If the failure continues then contact Siemens customer support
		63	Fluid temp. out of specification	Reduce the fluid temperature. If the failure continues then contact Siemens customer support

Siemens 	NAMUR 	ID	Diagnostic	Action
		64	Frame temp. out of specification	Increase fluid temperature and check that ambient temperature is within specified limits. If the failure continues then contact Siemens customer support
		65	Frame temp. out of specification	Reduce fluid temperature and check that ambient temperature is within specified limits. If the failure continues then contact Siemens customer support
		69	"Empty Tube Limit" exceeded	Make sure that the sensor is filled with liquid and that the liquid conductivity is within the specified "Empty Tube Limit"
		70	Too little fluid in tube	Make sure that the sensor is filled with liquid
		96	Massflow above upper alarm limit	Check process conditions or align limit to normal operation. Adjust parameter "Upper Limit Alarm"
		99	Massflow below lower alarm limit	Check process conditions or align limit to normal operation. Adjust parameter "Lower Limit Alarm"
		100	Volumeflow above upper alarm limit	Check process conditions or align limit to normal operation. Adjust parameter "Upper Limit Alarm"
		103	Volumeflow below lower alarm limit	Check process conditions or align limit to normal operation. Adjust parameter "Lower Limit Alarm"
		104	Density above upper alarm limit	Check process conditions or align limit to normal operation. Adjust parameter "Upper Limit Alarm"
		107	Density below lower alarm limit	Check process conditions or align limit to normal operation. Adjust parameter "Lower Limit Alarm"
		108	Fluid temp. above upper alarm limit	Check process conditions or align limit to normal operation. Adjust parameter "Upper Limit Alarm"
		111	Fluid temp. below lower alarm limit	Check process conditions or align limit to normal operation. Adjust parameter "Lower Limit Alarm"
		112	Fraction A % above upper alarm limit	Check process conditions or align limit to normal operation. Adjust parameter "Upper Limit Alarm"
		115	Fraction A % below lower alarm limit	Check process conditions or align limit to normal operation. Adjust parameter "Lower Limit Alarm"
		116	Fraction B % above upper alarm limit	Check process conditions or align limit to normal operation. Adjust parameter "Upper Limit Alarm"
		119	Fraction B % below lower alarm limit	Check process conditions or align limit to normal operation. Adjust parameter "Lower Limit Alarm"
		120	Fraction A flow above upper alarm limit	Check process conditions or align limit to normal operation. Adjust parameter "Upper Limit Alarm"
		123	Fraction A flow below lower alarm limit	Check process conditions or align limit to normal operation. Adjust parameter "Lower Limit Alarm"
		124	Fraction B flow above upper alarm limit	Check process conditions or align limit to normal operation. Adjust parameter "Upper Limit Alarm"
		127	Fraction B flow below lower alarm limit	Check process conditions or align limit to normal operation. Adjust parameter "Lower Limit Alarm"
		128	Ref. density above upper alarm limit	Check process conditions or align limit to normal operation. Adjust parameter "Upper Limit Alarm"

Alarms and system messages

10.2 Alarm messages

Siemens 	NAMUR 	ID	Diagnostic	Action
		131	Ref. density below lower alarm limit	Check process conditions or align limit to normal operation. Adjust parameter "Lower Limit Alarm"
		132	Corr. volumeflow above upper alarm limit	Check process conditions or align limit to normal operation. Adjust parameter "Upper Limit Alarm"
		135	Corr. volumeflow below lower alarm limit	Check process conditions or align limit to normal operation. Adjust parameter "Lower Limit Alarm"
		136	Totalizer 1 above upper alarm limit	Check process conditions or align limit to normal operation. Adjust parameter "Upper Limit Alarm"
		139	Totalizer 1 below lower alarm limit	Check process conditions or align limit to normal operation. Adjust parameter "Lower Limit Alarm"
		140	Totalizer 2 above upper alarm limit	Check process conditions or align limit to normal operation. Adjust parameter "Upper Limit Alarm"
		143	Totalizer 2 below lower alarm limit	Check process conditions or align limit to normal operation. Adjust parameter "Lower Limit Alarm"
		144	Totalizer 3 above upper alarm limit	Check process conditions or align limit to normal operation. Adjust parameter "Upper Limit Alarm"
		147	Totalizer 3 below lower alarm limit	Check process conditions or align limit to normal operation. Adjust parameter "Lower Limit Alarm"
		148	Transmitter temp. above upper alarm limit	Check process conditions or align limit to normal operation. Adjust parameter "Upper Limit Alarm"
		149	Transmitter temp. below lower alarm limit	Check process conditions or align limit to normal operation. Adjust parameter "Lower Limit Alarm"
		151	Sensor serial number mismatch	SensorFlash backup is disabled due to mismatch of serial numbers between sensor front-end and SensorFlash
		152	Transmitter serial number mismatch	SensorFlash backup is disabled due to mismatch of serial numbers between transmitter and SensorFlash
		192	Dosing time overrun	Check installation. If ok, increase "Duration Time"
		193	Dosing quantity overrun	Check installation. If ok, decrease "Overrun Value"
		195	Current output value below Lower Scaling	Check process conditions or align limit to normal operation. Adjust channel 2 parameter "Lower Scaling"
		196	Current output value above Upper Scaling	Check process conditions or align limit to normal operation. Adjust channel 2 parameter "Upper Scaling"
		198	Frequency output value below Lower Scaling	Check process conditions or align limit to normal operation. Adjust channel 2 parameter "Flow Value Low"
		199	Frequency output value above Upper Scaling	Check process conditions or align limit to normal operation. Adjust channel 2 parameter "Flow Value High"
		200	Pulse overflow	Pulse output insufficient pulse separation. Increase "Amount Per Pulse" or reduce "Pulse Width" on channel 2
		201	Current output value below Lower Scaling	Check process conditions or align limit to normal operation. Adjust channel 3 parameter "Lower Scaling"
		202	Current output value above Upper Scaling	Check process conditions or align limit to normal operation. Adjust channel 3 parameter "Upper Scaling"





Siemens 	NAMUR 	ID	Diagnostic	Action
		204	Frequency output value below Lower Scaling	Check process conditions or align limit to normal operation. Adjust channel 3 parameter "Flow Value Low"
		205	Frequency output value above Upper Scaling	Check process conditions or align limit to normal operation. Adjust channel 3 parameter ""Flow Value High"
		206	Pulse overflow	Pulse output insufficient pulse separation. Increase "Amount Per Pulse" or reduce "Pulse Width" on channel 3
		207	Current output value below Lower Scaling	Check process conditions or align limit to normal operation. Adjust channel 4 parameter "Lower Scaling"
		208	Current output value above Upper Scaling	Check process conditions or align limit to normal operation. Adjust channel 4 parameter "Upper Scaling"
		210	Frequency output value below Lower Scaling	Check process conditions or align limit to normal operation. Adjust channel 4 parameter "Flow Value Low"
		211	Frequency output value above Upper Scaling	Check process conditions or align limit to normal operation. Adjust channel 4 parameter ""Flow Value High"
		212	Pulse overflow	Pulse output insufficient pulse separation. Increase "Amount Per Pulse" or reduce "Pulse Width" on channel 4

Table 10-5 Alarm class Process value warning (Siemens standard), Off-specification (NAMUR)

Siemens 	NAMUR 	ID	Diagnostic	Action
		66	"Standard Deviation" above limit (shown for only 2 seconds)	Measurement continues with values from last successful zero point adjustment. Improve conditions for automatic zero point adjustment and repeat adjustment.
		67	"Zero Point Offset" above limit (shown for only 2 seconds)	Measurement continues with values from last successful zero point adjustment. Improve conditions for automatic zero point adjustment and repeat adjustment.
		68	Zero point adjustment failed (shown for only 2 seconds)	Measurement continues with values from last successful zero point adjustment. Improve conditions for automatic zero point adjustment and repeat adjustment.
		97	Massflow above upper warning limit	Check process conditions or align limit to normal operation. Adjust parameter "Upper Limit Warning"
		98	Massflow below lower warning alarm limit	Check process conditions or align limit to normal operation. Adjust parameter "Lower Limit Warning"
		101	Volumeflow above upper warning limit	Check process conditions or align limit to normal operation. Adjust parameter "Upper Limit Warning"
		102	Volumeflow below lower warning limit	Check process conditions or align limit to normal operation. Adjust parameter "Lower Limit Warning"
		105	Density above upper warning limit	Check process conditions or align limit to normal operation. Adjust parameter "Upper Limit Warning"

Alarms and system messages

10.2 Alarm messages





Siemens 	NAMUR 	ID	Diagnostic	Action
		106	Density below lower warning limit	Check process conditions or align limit to normal operation. Adjust parameter "Lower Limit Warning"
		109	Fluid temp. above upper warning limit	Check process conditions or align limit to normal operation. Adjust parameter "Upper Limit Warning"
		110	Fluid temp. below lower warning limit	Check process conditions or align limit to normal operation. Adjust parameter "Lower Limit Warning"
		113	Fraction A % above upper warning limit	Check process conditions or align limit to normal operation. Adjust parameter "Upper Limit Warning"
		114	Fraction A % below lower warning limit	Check process conditions or align limit to normal operation. Adjust parameter "Lower Limit Warning"
		117	Fraction B % above upper warning limit	Check process conditions or align limit to normal operation. Adjust parameter "Upper Limit Warning"
		118	Fraction B % below lower warning limit	Check process conditions or align limit to normal operation. Adjust parameter "Lower Limit Warning"
		121	Fraction A flow above upper warning limit	Check process conditions or align limit to normal operation. Adjust parameter "Upper Limit Warning"
		122	Fraction A flow below lower warning limit	Check process conditions or align limit to normal operation. Adjust parameter "Lower Limit Warning"
		125	Fraction B flow above upper warning limit	Check process conditions or align limit to normal operation. Adjust parameter "Upper Limit Warning"
		126	Fraction B flow below lower warning limit	Check process conditions or align limit to normal operation. Adjust parameter "Lower Limit Warning"
		129	Ref. density above upper warning limit	Check process conditions or align limit to normal operation. Adjust parameter "Upper Limit Warning"
		130	Ref. density below lower warning limit	Check process conditions or align limit to normal operation. Adjust parameter "Lower Limit Warning"
		133	Corr. volumeflow above upper warning limit	Check process conditions or align limit to normal operation. Adjust parameter "Upper Limit Warning"
		134	Corr. volumeflow below lower warning limit	Check process conditions or align limit to normal operation. Adjust parameter "Lower Limit Warning"
		137	Totalizer 1 above upper warning limit	Check process conditions or align limit to normal operation. Adjust parameter "Upper Limit Warning"
		138	Totalizer 1 below lower warning limit	Check process conditions or align limit to normal operation. Adjust parameter "Lower Limit Warning"
		141	Totalizer 2 above upper warning limit	Check process conditions or align limit to normal operation. Adjust parameter "Upper Limit Warning"
		142	Totalizer 2 below lower warning limit	Check process conditions or align limit to normal operation. Adjust parameter "Lower Limit Warning"
		145	Totalizer 3 above upper warning limit	Check process conditions or align limit to normal operation. Adjust parameter "Upper Limit Warning"
		146	Totalizer 3 below lower warning limit	Check process conditions or align limit to normal operation. Adjust parameter "Lower Limit Warning"

Table 10-6 Alarm class Functional check (Siemens standard), Functional check (NAMUR)

Siemens 	NAMUR 	ID	Diagnostic	Action
		160	Massflow process value is simulated	Disable "Simulation" before returning to normal operation
		161	Volumeflow process value is simulated	Disable "Simulation" before returning to normal operation
		162	Density process value is simulated	Disable "Simulation" before returning to normal operation
		163	Fluid temp. process value is simulated	Disable "Simulation" before returning to normal operation
		164	Fraction process value is simulated	Disable "Simulation" before returning to normal operation
		166	Corr. volumeflow process value is simulated	Disable "Simulation" before returning to normal operation
		167	Totalizer 1 process value is simulated	Disable "Simulation" before returning to normal operation
		168	Totalizer 2 process value is simulated	Disable "Simulation" before returning to normal operation
		169	Totalizer 3 process value is simulated	Disable "Simulation" before returning to normal operation
		170	Loop current process value is simulated	Disable "Simulation" before returning to normal operation

Service and maintenance

11.1 Maintenance

The device is maintenance-free, however, a periodic inspection according to pertinent directives and regulations must be carried out.

An inspection can include check of:

- Ambient conditions
- Seal integrity of the process connections, cable entries, and cover screws
- Reliability of power supply, lightning protection, and grounds

11.2 Service information

Service information is information about the condition of the device used for diagnostics and service purposes.

Service information parameters

The basic service information parameters are:

- Driver Current
- Pickup 1 Amplitude
- Pickup 2 Amplitude
- Sensor Frequency
- Frame Temperature
- Process Media Temperature
- Zero Point Adjustment Auto/Manual
- Zero Point Offset Value
- Manual Zero Point
- Zero Point Standard Deviation

11.3 Recalibration

Siemens A/S, Flow Instruments offers to recalibrate the sensor at our works in Denmark. The following calibration types are offered as standard according to configuration (standard, density, °Brix/°Plato, fraction):

- Standard calibration
- Customer specified calibration

- Accredited Siemens ISO/IEC 17025 calibration
- Density calibration (incl. fraction setup if requested)
- Witness calibration

Note

SensorFlash

For sensor recalibration the SensorFlash memory unit must always be returned with the sensor.

11.4 Technical support

If you have any technical questions about the device described in these Operating Instructions and do not find the right answers, you can contact Customer Support:

- Via the Internet using the **Support Request:**
Support request (<http://www.siemens.com/automation/support-request>)
- Via Phone:
 - Europe: +49 (0)911 895 7222
 - America: +1 423 262 5710
 - Asia-Pacific: +86 10 6475 7575

Further information about our technical support is available on the Internet at
Technical support (<http://support.automation.siemens.com/WW/view/en/16604318>)

Service & Support on the Internet

In addition to our documentation, we offer a comprehensive knowledge base online on the Internet at:

Service and support (<http://www.siemens.com/automation/service&support>)

There you will find:

- The latest product information, FAQs, downloads, tips and tricks.
- Our newsletter, providing you with the latest information about your products.
- Our bulletin board, where users and specialists share their knowledge worldwide.
- You can find your local contact partner for Industry Automation and Drives Technologies in our partner database.
- Information about field service, repairs, spare parts and lots more under "Services."

Additional Support

Please contact your local Siemens representative and offices if you have additional questions about the device.

Find your local contact partner at: <http://www.automation.siemens.com/partner> (<http://www.automation.siemens.com/partner>)

11.5 Transportation and storage

To guarantee sufficient protection during transport and storage, observe the following:

- Keep the original packaging for subsequent transportation.
- Devices/replacement parts should be returned in their original packaging.
- If the original packaging is no longer available, ensure that all shipments are properly packaged to provide sufficient protection during transport. Siemens cannot assume liability for any costs associated with transportation damages.

 CAUTION
Insufficient protection during storage
The packaging only provides limited protection against moisture and infiltration.
<ul style="list-style-type: none">• Provide additional packaging as necessary.

Special conditions for storage and transportation of the device are listed in "Technical data" (Page 178).

11.6 Cleaning

Cleaning the enclosure

- Clean the outside of the enclosure and the display window using a cloth moistened with water or a mild detergent.
- Do not use aggressive cleaning agents or solvents. Plastic components or painted surfaces could be damaged.

11.7 Maintenance work

 CAUTION
Hot surfaces Danger of burns during maintenance work on parts having surface temperatures exceeding 70 °C (158 °F). <ul style="list-style-type: none">• Take corresponding protective measures, for example by wearing protective gloves.• After carrying out maintenance, remount touch protection measures.

 WARNING
Humid environment Danger of electric shock. <ul style="list-style-type: none">• Avoid working on the device when it is energized.• If working on an energized device is necessary, ensure that the environment is dry.• Make sure when carrying out cleaning and maintenance work that no moisture penetrates the inside of the device.

 CAUTION
Dangerous voltage at open device Danger of electric shock when the enclosure is opened or enclosure parts are removed. <ul style="list-style-type: none">• Before you open the enclosure or remove enclosure parts, de-energize the device.• If maintenance measures in an energized state are necessary, observe the particular precautionary measures. Have maintenance work carried out by qualified personnel.

 WARNING
Hot, toxic or corrosive process media Danger of injury during maintenance work. When working on the process connection, hot, toxic or corrosive process media could be released. <ul style="list-style-type: none">• As long as the device is under pressure, do not loosen process connections and do not remove any parts that are pressurized.• Before opening or removing the device ensure that process media cannot be released.

11.8 Repair

11.8.1 Unit repair

NOTICE

Repair and service must be carried out by Siemens authorized personnel only.

Note

Siemens defines flow sensors as non-repairable products.

 **WARNING****Impermissible repair of explosion protected devices**

Danger of explosion in areas subject to explosion hazard.

- Repair must be carried out by Siemens authorized personnel only.

 **WARNING****Impermissible accessories and spare parts**

Danger of explosion in areas subject to explosion hazard.

- Only use original accessories or original spare parts.
- Observe all relevant installation and safety instructions described in the instructions for the device or enclosed with the accessory or spare part.

11.9 Return and disposal

 **WARNING**

Incorrect disassembly

The following dangers may result through incorrect disassembly:

- Injury through electric shock
- Danger through emerging media when connected to the process
- Danger of explosion in hazardous area

In order to disassemble correctly, observe the following:

- Before starting work, make sure that you have switched off all physical variables such as pressure, temperature, electricity etc. or that they have a harmless value.
- If the device contains dangerous media, it must be emptied prior to disassembly. Make sure that no environmentally hazardous media are released.
- Secure the remaining connections so that no damage can result if the process is started unintentionally.

11.9.1 Return procedures

Enclose the delivery note, the cover note for return delivery and the declaration of decontamination form on the outside of the package in a well-fastened clear document pouch.

Required forms

- **Delivery Note**
- **Cover Note for Return Delivery** with the following information
Cover note (<http://support.automation.siemens.com/WW/view/en/16604370>)
 - product (ordering number)
 - number of devices or spare parts returned
 - reason for the return
- **Declaration of Decontamination**
Declaration of Decontamination (http://pia.khe.siemens.com/efiles/feldg/files/Service/declaration_of_decontamination_en.pdf)
With this declaration you certify that the returned products/spare parts have been carefully cleaned and are free from any residues.
If the device has been operated together with toxic, caustic, flammable or water-damaging products, clean the device before return by rinsing or neutralizing. Ensure that all cavities are free from dangerous substances. Then, double-check the device to ensure the cleaning is completed.
We shall not service a device or spare part unless the declaration of decontamination confirms proper decontamination of the device or spare part. Shipments without a declaration of decontamination shall be cleaned professionally at your expense before further proceeding.

You can find the forms on the Internet and on the CD delivered with the device.

11.9.2 Device disposal



Devices identified by this symbol may not be disposed of in the municipal waste disposal services under observance of the Directive 2002/96/EC on waste electronic and electrical equipment (WEEE).

They can be returned to the supplier within the EC or to a locally approved disposal service. Observe the specific regulations valid in your country.

Troubleshooting/FAQs

12.1 Diagnosing with PDM

SIMATIC PDM is a suitable tool for diagnosing the device.

You can use SIMATIC PDM to read all available parameters to a table for analyzing offline, view online/actual process values and online/actual diagnostic information.

Requirements

The following procedure must be completed before diagnosing:

- Installation of PDM and PDM device driver
- Connection of HART interface.

Refer to "Commissioning with PDM" (Page 75).

Diagnosing with PDM

Online process values are available under menu "View->process values".

Online diagnostic information is available under menu "View->Device Status"

12.2 Troubleshooting sensor-related problems

Incorrect and unstable measurements, especially at low flows, are typically a result of an unstable zero point due to:

- Incorrect installation
- Air bubbles in the liquid
- Vibrations/Cross talk
- Solid particles in the liquid

In the following a 4-steps guide to troubleshooting is provided:

Step 1	Preliminary application inspection
Step 2	Zero point adjustment
Step 3	Measurement error calculation
Step 4	Application improvement

The guide will enable you to trace the reason for incorrect measurements and to improve the application.

12.2.1 Step 1: Inspecting the application

Ensure that:

1. The sensor is installed as described in "Installing/mounting" (Page 39).
2. The sensor is located in a vibration-free position. Vibrations can disturb the sensor and therefore cause measurement error.

Depending on application, you should furthermore ensure the following:

- Liquid application
Ensure that the sensor is filled with liquid and liquid only.
Air or gas bubbles in the liquid cause instability and can result in measurement errors.
Flush the pipe systems and the sensor for several minutes at maximum flowrate to remove any air bubbles which may be present.

Note

The liquid must be homogeneous in order to measure with high accuracy. If the liquid contains solid particles of greater density than the liquid, then these solids can settle, especially at low flow rates, which will cause instability in the sensor and lead to measurement errors.

- Gas application
Ensure that the gas pressure/temperature conditions contain sufficient superheat to prevent dewing or precipitation. If the gas contains vapor or droplets then these may precipitate, causing instability.

12.2.2 Step 2: Performing a zero point adjustment

The second step in the troubleshooting procedure is to zero point adjust the device. For further information on zero point adjustment, see "Commissioning" (Page 71).

12.2.3 Step 3: Calculating the measurement error

The result of the zero point adjustment will show you if the zero point was set under good and stable conditions.

The lower the obtained value of the parameter "Zero Point Standard Deviation", the lower is the achievable measuring error. For a well-installed flowmeter, the Zero Point Standard Deviation corresponds to the specified zero point stability for the sensor size, see "Performance (Page 176).

The parameter "Zero Point Standard Deviation" is located in the "Maintenance & Diagnostics" menu in the SIMATIC PDM.

Calculating the measurement error

Given the Zero Point Standard Deviation, the error expected for different flow rates can be calculated, without performing time-consuming measurements. So using this formula, one can

assess if the application can be used as-is, or whether to use more time improving the installation.

$$E = Z \times 100 \% / Q_m$$

Where:

E = measurement error in % of flowrate

Z = zero point standard deviation value in kg/h

Q_m = current flowrate in (kg/h)

Example 1: Low flow application

- DN 15 sensor. The sensor's nominal flowrate is specified to 3700 kg/h
- Zero point error (Zero Point Standard Deviation) value is specified as 0.2 kg/h
- Flow: Min. 10 kg/h - Max. 100 kg/h

After the zero point adjustment, the Zero Point Standard Deviation value 'Z' is read as 1 kg/h, that is 5 times greater than that specified for the sensor.

The error for a flowrate of 10 kg/h is estimated as:

- $E = 1 \text{ kg/h} \times 100\% / 10 \text{ kg/h} = 10\%$.

For a flowrate of 100 kg/h the error is estimated as:

- $E = 1 \text{ kg/h} \times 100\% / 100 \text{ kg/h} = 1\%$

For this application it is necessary to investigate more closely what the cause of the relatively high Zero Point Standard Deviation value is, in order to establish what needs to be done to improve the measurement accuracy.

Example 2 : High flow application

DN 15 sensor. The sensor flowrate is specified as max. 3700 kg/h

- The zero point error/ Zero Point Standard Deviation value is specified as 0.2 kg/h
- Flowrate: Min. 1000 kg/h - Max. 3000 kg/h

After the zero point adjustment, the Zero Point Standard Deviation value 'Z' is read as 1 kg/h, that is 5 times greater than specified for the sensor !

The error at a flowrate of 1000 kg/h is estimated as:

- $E = 1 \text{ kg/h} \times 100\% / 1000 \text{ kg/h} = 0.1\%$

At a flowrate of 3000 kg/h the error is estimated to be:

- $E = 1 \text{ kg/h} \times 100\% / 3000 \text{ kg/h} = 0.03\%$
Plus the linearity error of 0.1%

As can be seen, in this case it is not so important that the standard deviation is 1 kg/h. The error due to the zero point is only 0.1% for a flowrate of 1000 kg/h, and even less for a higher flowrate.

12.2 Troubleshooting sensor-related problems

So for this installation with the given flowrate and zero point error (Zero Point Standard Deviation value), you should typically choose not to spend more time finding ways to improve the application.

12.2.4 Step 4: Improving the application

In the following it is described how to find the causes of a high Zero Point Standard Deviation and how to improve the installation.

Setting Low Flow Cut-Off

In order to see if the zero point becomes more stable when making changes / adjustments, the Low Mass Flow Cut-Off (MassFlowCutOff) must be set to 0.0%.

When Low Flow Cut-Off has been set, it is possible to see the instability directly from the massflow in the online window ("View->Process variables")

This information can be used to troubleshoot. For example, tightening the brackets which hold the sensor, or turning off the pump to check if vibrations from the pump are disturbing the sensor, etc.

Incorrect installation of the sensor

- Has the sensor been correctly installed, that is fastened to the floor / wall or frame with good mounting brackets as shown in the instructions?

Especially for low flowrates, that is flowrates less than 10% of the maximum capacity of the flow meter, it is important that the sensor is correctly and stably installed.

If the sensor is not correctly fixed in place, the zero point of the sensor will change, leading to measuring errors.

Try to tighten up the sensor brackets to see whether the flow instability is reduced.

Vibrations and cross talk

Vibrations in the pipe system are normally generated by pumps.

Typically, cross talk is generated by two sensors positioned in close proximity in the same pipe, or installed upon the same rail or frame.

Vibrations / cross talk have a greater or lesser effect upon the zero point stability and therefore also the measurement accuracy.

1. Check whether there are vibrations.
Turn off the pump and check whether the zero point stability improves, that is if the flowrate fluctuation in kg/h is reduced.
If the sensor is disturbed by vibration from the pump, the installation should be improved or the pump should be exchanged, for example to another type.
2. Check for cross talk.
Turn off the power to the other flow meter(s) and wait approximately 2 minutes, so the vibrating tubes in the sensor have stopped vibrating. Then check if the zero point stability has improved, that is that the fluctuation in kg/h has been reduced. If this is the case, the sensors disturb one another and the installation should be improved.

Air in the liquid

When air is present in the liquid, the zero point becomes unstable, which leads to a poor measurement accuracy.

Checking for air:

- Check the Driver Current (View -> Device Status -> Amplitude / Frequency)
- Check if the Driver Current varies more than ± 1 mA. If this is the case, it is usually due to the presence of air or gas bubbles in the liquid.
- Increase the pressure in the sensor, creating a large back pressure upon the sensor by reducing the opening of the outlet valve or by increasing the pump pressure. Thereby the size of air bubbles inside the sensor will be minimized. If the value or the stability of Driver Current falls, it is proof that the liquid contains air or gas bubbles.

Typical causes of air in the liquid

- The entry pipe and sensor have not been properly filled with liquid. The pump cavitates, the rotary speed of the pump is too high in relation to the supply of liquid to the pump.
- The flow rate in the pipe is too high, so components sitting in front of the flowmeter can cause cavitation.
- If there is a filter installed before the flowmeter, it may be close to blocking, which also can cause cavitation.

Solid particles in the liquid

If the solid particles in a liquid have a density higher than that of the liquid, they can precipitate inside the sensor and cause instability which leads to a measurement error.

If solid particles are present in the liquid, they must be homogeneously distributed and have similar density as the liquid. Otherwise they can cause relatively large measurement errors.

It is important that the sensor is installed such that solid particles can easily run out of the sensor.

1. Ensure that the sensor is installed vertically with an upwards flow.
2. Check if solid particles are present in the liquid:
Take a sample of the liquid, fill a glass and see if the solids precipitate.

Technical data

13.1 Function and system design

Table 13-1 Designated use

Description	Specification
Measurement of process media	<ul style="list-style-type: none"> Fluid Group 1 (suitable for dangerous fluids) Aggregate state: Paste/light slurry, liquid and gas

Table 13-2 Function and system design

Description	Specification
Measuring principle	Coriolis
System architecture	<ul style="list-style-type: none"> Compact configuration Remote configuration (up to 225 m (738 ft))

13.2 SensorFlash

Table 13-3 SensorFlash

Description	Specification
Capacity	Standard: 1 GB Max. 2 GB
File system support	FAT32

13.3 Process variables

Table 13-4 Process variables

Description	Specification
Primary process variables	<ul style="list-style-type: none"> Massflow Density Process media temperature
Derived process variables	<ul style="list-style-type: none"> Volumeflow Corrected volumeflow Fraction A:B Fraction % A:B

Description	Specification			
Measurement range (water)	DN 15 (½")	DN 25 (1")	DN 50 (2")	DN 80 (3")
Massflow* kg/h (lb/h)	20 to 6400 (44 to 14 100)	200 to 17 700 (440 to 39 000)	750 to 70 700 (1650 to 156 000)	900 to 181 000 (1980 to 399 000)
Volume flow* m³/h (gpm)	0.02 to 6.4 (0.088 to 28.2)	0.2 to 17.7 (0.88 to 77.9)	0.75 to 70.7 (3.3 to 311)	0.9 to 181 (4.0 to 797)
Density	Up to 5000 kg/m³ (312 lb/ft³)			
Process media temperature	-50 to +200 °C (-58 to 392 °F)			
Pressure	1 to 100 bar depending on the connections			

*: Flowrates below minimum values in the table are measured and reported without accuracy guarantee being applied.

13.4 Bus communication

Table 13-5 HART communication

Description	Specification	More information
Manufacturer ID	42 (2A Hex)	Manufacturer ID parameter
Device ID	34 (22 Hex)	Device type parameter
HART protocol revision	7.2	HART protocol revision parameter
Device revision	1	Device revision parameter
Number of device variables	12	Number of process values, both measured and derived
Physical layers supported	FSK	Frequency Shift Keyed
Loop-powered	No	4-wire device
SIMATIC PDM EDD	1.00.00	Device driver version
SIMATIC PDM SW	6.0 SP2 and higher	Software version

13.5 Performance

Table 13-6 Reference conditions

Description	Specification
Flow conditions	Fully developed flow profile
Process media	Water
Process media temperature	20 °C (68 °F)
Ambient temperature]	25 °C (77 °F)

Description	Specification
Process media pressure	2 bar (29 psi)
Process media density	0.997 g/cm ³ (62.2 lb/ft ³)
Reference device orientation	Horizontal installation, tubes down, flow in direction of arrow on casing, see "Installing/Mounting" (Page 42).

Table 13-7 Massflow accuracy

Description	Specification			
	DN 15	DN 25	DN 50	DN 80
Sensor size				
Nominal flowrate [kg/h] (lb/h)	3700 (8157)	11 500 (25 353)	52 000 (114 640)	136 000 (299 828)
Max. zero point stability [kg/h]	±0.2	±2.0	±7.5	±9.0
Measuring accuracy [%]	±0.10			
Repeatability error [%]	±0.05			

Table 13-8 Density accuracy

Description	Specification
Density accuracy, standard calibration [kg/m ³]	±5
Density accuracy, extended calibration [kg/m ³]	±1
Density repeatability [kg/m ³]	±0.25
Density, media pressure effect [(kg/m ³)/Bar]	±0.5
Density, media temperature effect [(kg/h)/°C]	±0.1

Table 13-9 Media temperature accuracy

Description	Specification
Media temperature accuracy [°C]	±1
Media temperature repeatability [°C]	±0.25

Table 13-10 Additional error by deviations from reference conditions

Description	Specification			
	DN 15	DN 25	DN 50	DN 80
Sensor size				
Effect of process pressure [% of actual flowrate per bar]	±0.015	±0.015	±0.015	±0.015
Effect of process pressure at nominal flowrate [(kg/h) per bar]	0.75	1.7	7.8	27
Effect of ambient temperature [% / K actual flowrate]	< ±0.003	< ±0.003	< ±0.003	< ±0.003
Display/Frequency/Pulse output:				
Effect of power supply fluctuations	None	None	None	None
Effect of media temperature [(kg/h)/°C]	±0.0875	±0.175	±1.05	±3.15

13.6 Rated operating conditions

Table 13-11 Basic conditions

Description		Specification
Ambient temperature (°C[°F]) (Humidity max. 90 %)	Operation:	
	Transmitter without display	-40 to +60 [-40 to +140]
	Transmitter with display	-20 to +60 [0 to 140]
Ambient temperature (°C[°F]) (Humidity max. 90 %)	Storage:	
	Transmitter without display	-40 to +70 [-40 to +158]
	Transmitter with display	-40 to +70 [-40 to +158]
Climate class		DIN 60721-3-4
Altitude		Up to 2000 m (6560 ft)
Relative humidity [%]		95
Shock resistance		On request
Thermal shock		On request
Vibration resistance		On request
EMC performance	Emission	EN/IEC 62000-6-4 (Industry)
	Immunity	EN/IEC 62000-6-2 (Industry)

Table 13-12 Cleaning and sterilizing conditions

Description	Specification
Cleaning method	<ul style="list-style-type: none"> • CIP • SIP
Cleaning temperature	On request
Cleaning frequency	On request
Cleaning duration	On request

Table 13-13 Process media conditions

Description	Specification
Process media temperature (T_s) (min to max) [°C]	-50 to +200
Process media density (min to max) [kg/m ³]	1 to 5000
Process media gauge pressure (min to max) [bar]	0 to 100
Process media absolute pressure (min to max) [bar]	1 to 101
Process media viscosity	Gases and non-compressible liquids
Pressure drop	See "Pressure drop curves" (Page 179)
Pressure temperature ratings	See "Pressure - temperature ratings" (Page 179)

13.7 Pressure drop curves

The pressure drop is dimension dependent and influenced by process media viscosity and density.

Pressure drop information is available on request

13.8 Pressure - temperature ratings

Table 13-14 EN1092-1:2008-09

PN (bar)	Temperature TS (°C)					
	-50	0	50	100	150	200
16	16.0	16.0	16.0	15.2	13.8	12.7
40	40.0	40.0	40.0	37.9	34.5	31.8
63	63.0	63.0	63.0	59.7	54.3	50.1
100	100.0	100.0	100.0	94.8	86.2	79.5

Table 13-15 ISO228-G and ASME B1.20.1 NPT

PN (bar)	Temperature TS (°C)					
	-50	0	50	100	150	200
100	100.0	100.0	100.0	100.0	100.0	100.0

Table 13-16 ASME 16.5-2009

Class	Temperature TS (°C)					
	-50	0	50	100	150	200
150	15.8	15.8	15.3	13.3	12.1	11.1
300	41.3	41.3	39.8	34.8	31.4	29.0
600	82.6	82.6	79.7	69.6	62.9	58.1

Table 13-17 DIN 11851:1998

PN (bar)	Temperature TS (°C)					
	-50	0	50	100	140	
25	25	25	25	25	25	25
40	40	40	40	40	40	40

Table 13-18 DIN 32676:2009 & ISO 2852:1993

PN (bar)	Temperature TS (°C)					
	-50	0	50	100	140	
10	10	10	10	10	10	10
16	16	16	16	16	16	16
25	25	25	25	25	25	25

Table 13-19 DIN 11864:1998 & ISO 2853:1993

PN (bar)	Temperature TS (°C)				
	-50	0	50	100	140
25	25	25	25	25	25
40	40	40	40	40	40

Note

Test pressure

Maximum allowable test pressure (MATP) for the flowmeter and process connection is 1.5 times the nominal pressure.

13.9 Design

Sensor design

Table 13-20 Sensor design

Description	Specification
Dimension and weight	See "Dimensions and weight" (Page 197)
Process connectors	<ul style="list-style-type: none"> • EN1092-1 B1, PN40, PN100 • ISO 228-1 G • ASME B1 20.1 NPT • ASME B16.5-2009, CI 150, CI 600 • DIN 11851 • DIN 32676 • DIN 11864-1, DIN 11864-2 • ISO 2852 • ISO 2853
Electrical connection	<ul style="list-style-type: none"> • M12 connector with 4-wire cable • Standard cable with polymer / brass / stainless steel cable glands • Metric or NPT conduit entries
Material	
Measuring tubes	AISI 316L / W1.4435
Process connectors	<ul style="list-style-type: none"> • Standard: AISI 316L / W1.4435 • Hygienic: AISI 316L / W1.4435
Sensor enclosure	AISI 304 / W1.4301
DSL enclosure	Aluminum with corrosion-resistant coating

Description	Specification
Measuring tube design	Split flow through 2 parallel tubes with combined cross-section area 50% of the nominal pipe The measuring tubes are bent in a trapezoidal curve
Measuring tube surface roughness	<ul style="list-style-type: none"> • Standard: 1.6 µm • Hygienic: 0.8 µm
Self-draining design	Yes

Transmitter design

Table 13-21 Transmitter design

Description	Specification
Dimension and weight	See "Dimensions and weight" (Page 197)
Design	Compact or remote
Material	Aluminum with corrosion-resistant coating
Ingress protection	IP67/NEMA 4X to EN/IEC 60529 (1 mH ₂ O for 30 min.)
Mechanical load	18 to 1000 Hz random, 3.17 g RMS, in all directions, to IEC 68-2-36

13.10 Inputs and outputs

Table 13-22 Current output

Description	Channel 1		Channels 2 to 4	
	NAMUR:	US:	NAMUR:	US:
Signal range	4 to 20 mA		0/4 to 20 mA	
Load	< 500 Ω (HART ≥ 230 Ω)		< 500 Ω	
Time constant (adjustable)	0.0 to 100 s		0.0 to 100 s	
Fault current	NAMUR:	US:	NAMUR:	US:
Measurement range (mA)	3.8 to 20.5	4 to 20.8	3.8 to 20.5	4 to 20.8
Minimum alarm (mA)	3.5	3.75	3.5	3.75
Maximum alarm (mA)	22.6	22.6	22.6	22.6
Customized failsafe mode	N/A		<ul style="list-style-type: none"> • Last good value • User-specific 	
Galvanic isolation	Isolation voltage: 500 V		Isolation voltage: 500 V	

Technical data

13.10 Inputs and outputs

Description	Channel 1	Channels 2 to 4
Cable	Standard industrial signal cable with 1 screened pair can be connected between the transmitter and the control system	Standard industrial signal cable with up to 3 twisted pairs with overall screen can be connected between the transmitter and the control system
Maximum voltage	24 V DC (active) 30 V DC (passive)	24 V DC (active) 30 V DC (passive)

Table 13-23 Digital output

Description	Channels 2 to 4
Pulse	41.6 μ s to 5 s pulse duration
Frequency	0 to 10 kHz, 50 % duty cycle, 120 % overscale provision
Load	< 500 Ω
Time constant (adjustable)	0 to 100 s
Active	0 to 24 V DC, 110 mA, short-circuit-protected
Passive	3 to 30 V DC, 110 mA
Functions	<ul style="list-style-type: none"> • Pulse • Frequency • Alarm level • Alarm number • Valve dosing control

Table 13-24 Relay output

Description	Channels 3 to 4
Type	Change-over voltage-free relay contact
Load	30 V AC, 110 mA
Functions	<ul style="list-style-type: none"> • Alarm level • Alarm number • Valve dosing control

Table 13-25 Digital input

Description	Channels 3 to 4
Voltage	15 to 30 V DC, 2 to 15 mA
Functionality	<ul style="list-style-type: none"> • Start/stop/hold/continue dosing • Zero point adjustment • Reset totalizer 1, 2 or 3 • Reset all totalizers • Freeze output

13.11 Local User Interface

Table 13-26 LUI

Description	Specification
Display	Full graphical Resolution: 240 x 160 pixels Size: 60.0 x 41.4 mm (2.36" x 1.63")
Ambient temperature	Storage: -40 to +60 °C (-40 to +140 °F) Operation: -20 to +60 °C (-4 to +140 °F) The readability of the display may be impaired at temperatures outside the permitted operating temperature range

13.12 Power supply

Table 13-27 Power supply

Description	Specification
Supply Voltage [V]	<ul style="list-style-type: none"> • 100 to 240 V AC +10/-15%, 47 to 63 Hz • 24 to 90 V DC +20/-20%
Power consumption	15 VA/7.5 W
Fluctuation	<ul style="list-style-type: none"> • Transient overvoltages up to the levels of overvoltage category II • Temporary overvoltages occurring on mains supply only
Reverse polarity protection (y / n)	Yes
Galvanic isolation	500 V DC

13.13 Cables and cable entries

Table 13-28 Sensor cable, basic data

Description	Specification
Number of conductors	4
Square area [mm ²]	1.5
Screen	Yes
Outside color	Standard version: gray Ex version: light-blue
External diameter [mm]	7
Maximum length	150 m (492 ft.)
Installation environment	Industrial including chemical processing plants
Insulation material	On request

13.13 Cables and cable entries

Description	Specification
Halogen-free	Yes
RoHS compliant	Yes
Torsional strength	<ul style="list-style-type: none"> • 1 million cycles at ± 180° on 1 meter • Not adapted for garland mounting (festoon)
Permissible temperature range [°C (°F)]	-40to +80 (-40 to +176)
Min. bending radius allowed	Single 5 X ø

Table 13-29 Signal cable recommendations

Description	Specification
Loop resistance [Ohm/km]	≤ 120
Signal run time [ns/m]	≤ 4.7
Insulation resistance [MOhm*km]	≥ 500
Characteristic impedance 1 – 100 MHz [Ohm]	100 (±15)
Attenuation @ 1 Mhz	< 2.9 dB/100 m
Operating voltage (peak) [V]	≤ 100
Test voltage (wire/wire/screen rms 50 Hz 1 min) [V]	= 700

Electrical data at reference temperature (20 °C)

Table 13-30 Transmitter cable glands and entries

Description	Specification
Glands	<ul style="list-style-type: none"> • Material <ul style="list-style-type: none"> – Nylon¹⁾ – Brass/Ni plated – Stainless steel AISI 316/1.4404 • Cable cross section <ul style="list-style-type: none"> – Ø 8 to 17 mm (0.31" to 0.67") – Ø 5 to 13 mm (0.20" to 0.51")
Entries	1 x M25 (for current output/communication, channel 1) and 2 x M20 (for supply and channels 2 to 4) or 1 x ½" NPT (for current output/communication, channel 1) and 2 x ½" NPT (for supply and channels 2 to 4)

¹⁾: If operating temperature is below -20 °C (-4 °F), use Brass/Ni plated or stainless steel cable glands.

Note

For hygienic applications (3A & EHEDG) the cable glands and blind plugs must be made from corrosion resistant material like nickel brass, stainless steel or plastic, the exposed threads must be minimized when they are tightened up on the cable and they must have a seal (plastic or rubber) under the threads where they screw into the terminal housing or enclosure.

13.14 Installation torques

Table 13-31 Installation torques

Description	Torque (Nm)	
Pressure guard fittings	80	
Wall bracket screws	10	
Transmitter to wall bracket	25	
Transmitter pedestal lock screw	Compact version:	10
	Remote version:	6
Pedestal lock screw cap	10	
Cable gland to housing (metric)	10	
Cable gland to cable	Minimum 15	

13.15 Certificates and approvals HART

Table 13-32 Certificates and approvals

Description	Specification
ATEX	<p>FCT030 transmitter (can be installed in Zone 1 for gas and Zone 21 for dust): Certificate SIRA 11ATEX1342X: ⓧ II 2(1) GD Ex d e [ia Ga] IIC T6 Gb Ta = -40°C to +60°C Ex Tb [ia Da] IIIC T85°C Db</p> <p>FCS400 sensor + DSL (can be installed in Zone 1 for gas and Zone 20 for dust): ATEX Certificate: SIRA 11ATEX1341X ⓧ II 1/2 GD II 1D Ex d ia IIC T* Gb Ex Ta IIIC T135°C** Da Ta = -40°C to +60°C</p> <p>* Temperature class (dependent on the "Maximum Process Temperature", see "Special Conditions for Safe Use") ** See "Special Condition for Safe Use"</p> <p>FC430 compact system (can be installed in Zone 1 for gas and Zone 21 for dust): ATEX certificate SIRA 12ATEX1102X ⓧ II 1/2 GD Ex d e ia [ia GA] IIC T* Gb Ta = -40°C to ** °C Ex Tb [ia Da] IIIC T 85°C Db</p> <p>* Temperature class (dependent on the "Maximum Process Temperature") ** Upper ambient temperature (dependent on the "Maximum Process Temperature")</p>

Description	Specification
IECEX	<p>FCT030 transmitter (can be installed in Zone 1 for gas and Zone 21 for dust): Certificate: IECEX SIR 11.0150X Ex d e ia [ia Ga] IIC T6 Gb Ta = -40°C to +60°C. Ex tb [ia Da] IIIC T85°C Db</p> <p>FCS400 sensor + DSL (can be installed in Zone 1 for gas and Zone 20 for dust): Certificate: IECEX SIR 11.0149X Ex d ia IIC T* Gb Ex ta IIIC T135dgC** Da (Ta = -40°C to +60°C) * Temperature class (dependent on the "Maximum Process Temperature", see "Conditions of Certification") ** See "Conditions of Certification"</p> <p>FC430 compact system (can be installed in Zone 1 for gas and Zone 21 for dust): Certificate: IECEX SIR 12.0040X Ex d e ia [ia Da] IIC Gb Ta= -40 to ** °C Ex tb [ia Da] IIIC T 85°C Db * Temperature class (dependent on the "Maximum Process Temperature") ** Upper ambient temperature (dependent on the "Maximum Process Temperature")</p>
FM	<p>Transmitter (FCT030), Sensor with DSL (FCS400) and Compact (FC430):</p> <p>Class I Division 1 Groups A,B,C,D T* (XP, IS) Class II Divison 1 Groups E,F,G Class III Division 1 Group H (granulates) Class I Zone 1 and Zone 21 Class 1 Zone 1 and Zone 20 (FCS400 remote) *: Depends on media temperature, ambient temperature and configuration (compact or remote) (T6-T2)</p>
Custody Transfer	<p>FC430 compact and remote systems: OIML R 117-1 accuracy class 0.3 for liquids other than water 2004/22/EC MID 005. For information regarding tested liquids, contact Siemens</p>
Hygienic version	<p>3A EHEDG EC1935:2004 and 2023:2006 (food contact material: stainless steel)</p>
Pressure equipment	<p>97/23/EC Pressure Equipment Directive (PED) Canadian Registration Number (CRN)</p>

13.16 PED

The pressure equipment directive 97/23/EC applies to the alignment of the statutory orders of the European member states for pressure equipment. Such equipment in the sense of the directive includes vessels, pipelines and accessories with a maximum allowable pressure of more than 0.5 bar above atmospheric. Flowmeters are considered as piping.

A detailed risk analysis of the flowmeter has been performed in accordance with the PED 97/23/EC. All risks are assessed to be "none" provided that the procedures and standards referenced in these operating instructions are observed.

13.16.1 Division according to the danger potential

Flowmeters, which are categorized as piping, are divided into categories according to danger potential (medium, pressure, nominal diameter). The flowmeters fall into the categories I to III or they are manufactured according to Article 3 Paragraph 3 - Sound Engineering Practice (SEP).





The following criteria are decisive for assessment of the danger potential, and are also shown in Diagrams 6 to 9.



Fluid group	Group 1 or 2
• Aggregate state	Liquid or gaseous
• Type of pressurized equipment	
– Pipeline	Product of pressure and volume ($PS * V$ [barL])

The maximum allowable temperature for the used liquids or gases is the maximum process temperature which can occur, as defined by the user. This must be within the limits defined for the equipment.

13.16.2 Division of media (liquid/gaseous) into the fluid groups

Table 13-33 Fluids are divided according to Article 9 into the following fluid groups:

Group 1	
<p>Explosive R phrases: for example: 2, 3 (1, 4, 5, 6, 9, 16, 18, 19, 44)</p> 	<p>Very toxic R phrases: for example: 26, 27, 28, 39 (32)</p> 
<p>Extremely flammable R phrases: for example: 12 (17)</p> 	<p>Toxic R phrases: for example: 23, 24, 25 (29, 31)</p> 

Group 1	
<p>Highly flammable R phrases: for example: 11, 15, 17 (10, 30)</p> 	<p>Oxidizing R phrases: for example: 7, 8, 9 (14, 15, 19)</p> 
<p>Flammable R phrases: for example 11 (10)</p> 	
<p>Group 2</p> <p>All fluids not belonging to Group 1. Also applies to fluids which are for example dangerous to the environment, corrosive, dangerous to health, irritant or carcinogenic (if not highly toxic).</p>	

13.16.3 Conformity assesment

Flowmeters of categories I to III comply with the safety requirements of the directive. They are affixed with the CE mark and an EC declaration of conformity is provided.

The flowmeters are subjected to the conformity assessment procedure - Module H.

Flowmeters according to Article 3 Paragraph 3 are designed and manufactured in accordance with sound engineering practice in Denmark. PED conformity reference is not affixed to the CE mark.

13.16.4 Diagrams

- Gases of fluid group 1
- Pipelines according to Article 3 Number 1.3 Letter a) First dash
- Exception: unstable gases belonging to Categories I and II must be included in Category III.

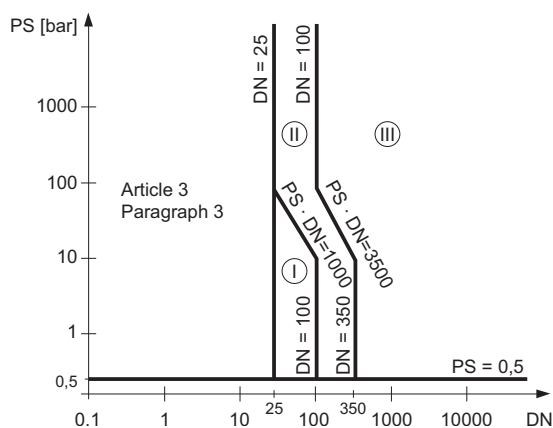

Figure 13-1 Diagram 6

- Gases of fluid group 2
- Pipelines according to Article 3 Number 1.3 Letter a) Second dash
- Exception: liquids at temperatures > 350 °C belonging to Category II must be included in Category III.

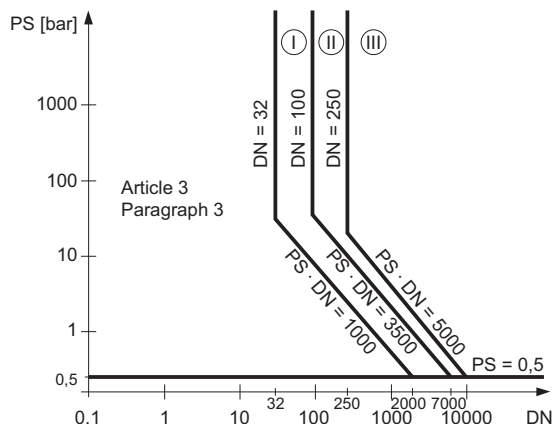

Figure 13-2 Diagram 7

- Liquids of fluid group 1
- Pipelines according to Article 3 Number 1.3 Letter b) First dash

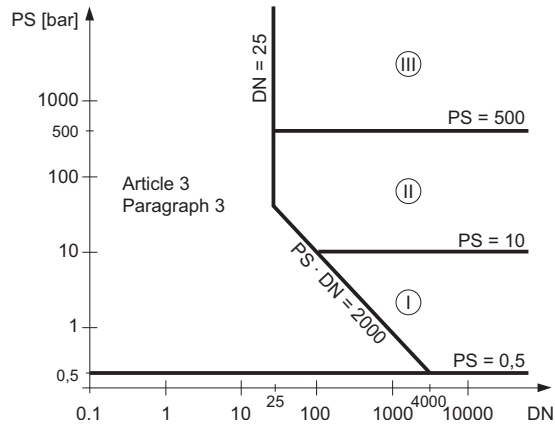

Figure 13-3 Diagram 8

- Liquids of fluid group 2
- Pipelines according to Article 3 Number 1.3 Letter b) Second dash

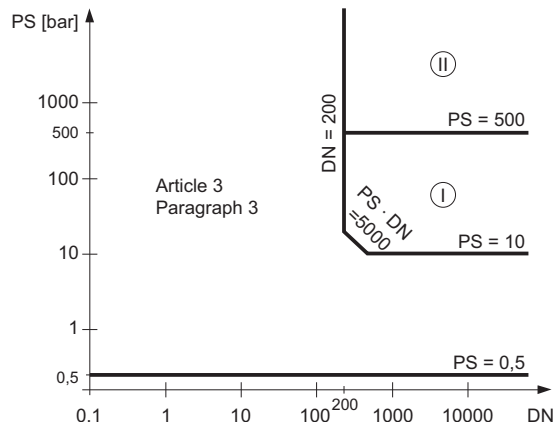

Figure 13-4 Diagram 9

Spare parts/Accessories

14.1 Ordering





In order to ensure that the ordering data you are using is not outdated, the latest ordering data is always available on the Internet: Catalog process instrumentation (<http://www.siemens.com/processinstrumentation/catalogs>)

⚠ WARNING
Repair of Ex-approved products
It is the customer's responsibility that repair of Ex-approved products fulfil national requirements.

14.2 Replaceable components

This table gives an overview of which components can be replaced.

Table 14-1 Overview of replaceable components

Component	Order number	Photo and position on exploded view	Hot swappable *
SITRANS FCT030 Display and keypad	A5E03548971	 ②	Yes
SITRANS FCT030 Compact Version sensor interface cassette	A5E03549142	 ②b	No
SITRANS FCT030 Remote Version sensor interface cassette	A5E03549098	 ②b	Yes
SITRANS FCT030 Display lid	A5E03549344	 ①	Yes Observe hazardous area access protocols!

Spare parts/Accessories

14.2 Replaceable components

Component	Order number	Photo and position on exploded view	Hot swappable *
SITRANS FCT030 Transmitter cassette HART (Active)	A5E03549357	⑨	No
SITRANS FCT030 Transmitter cassette HART (Passive)	A5E03549383	⑨	No
SITRANS FCT030 Bag of loose spare parts	A5E03549396		
SITRANS FCT030 Power supply 85-264 V AC (50/60 Hz) 18.5-100 V DC	A5E03549413		No
SITRANS FCT030 Blind lid large (122 mmø)	A5E03549429	⑮	Yes Observe hazardous area access protocols!
SITRANS FCT030 I/O Cassette (Quote FNN option from product code)	A5E03939114	⑰	No
SITRANS FCT030 SensorFlash 1 GB micro SD card	A5E03915258	④	Yes
SITRANS FCT030/DSL Blind lid small (85 mmø)	A5E03549295		Yes For DSL, observe hazardous area access protocols!
SITRANS FCS400 Remote version DSL cassette	A5E03549191		No

Component	Order number	Photo and position on exploded view	Hot swappable *
SITRANS FCS400 Remote version Sensor housing metric	A5E03549313	 ⑰	No
SITRANS FCS400 Remote version Sensor housing NPT	A5E03906080		No
SITRANS FCS400 Bag of loose parts for sensor	A5E03549324		
SITRANS FCT030 Remote version Mounting bracket Kit Wall and pipe mounting	A5E03906091		Yes
SITRANS FCS400 Remote version M12 option for DSL housing	A5E03906095		No
SITRANS FCT030 Remote version Socket, M12 pedestal	A5E03906104		No
SITRANS FCT030 Remote version Terminal house 1/2" NPT pedestal	A5E03906130		No

* Components may be replaced while power is on

Dimensions and weight

15.1 Sensor dimensions

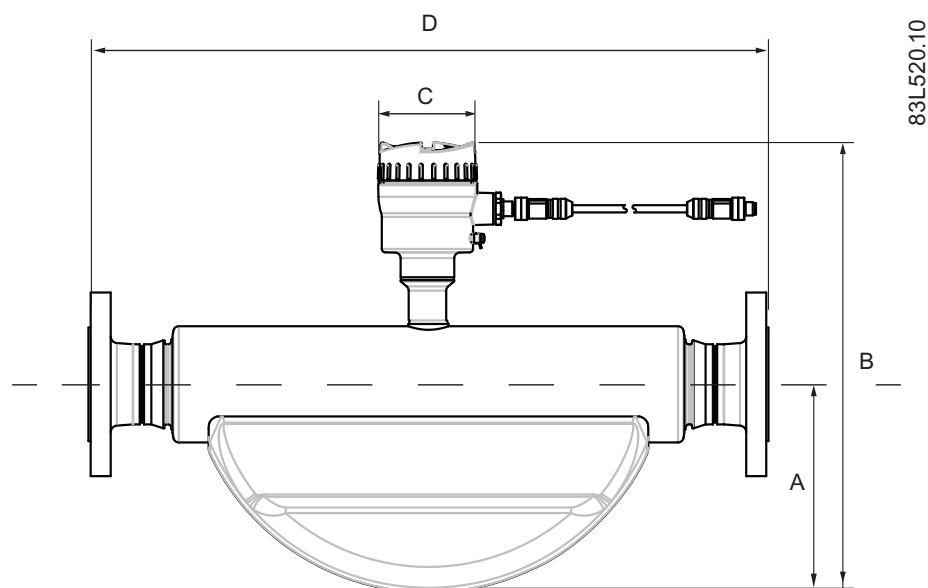

Table 15-1 Basic dimensions

Sensor DN	A in mm (inch)	B in mm (inch)	C in mm (inch)	Weight in kg (lb)
15 (½")	90 (3.54)	280 (11.0)	90 (3.54)	4.6 (10.1)
25 (1")	123 (4.84)	315 (12.4)	90 (3.54)	7.9 (17.4)
50 (2")	187 (7.36)	390 (15.4)	90 (3.54)	15 (33.1)
80 (3")	294 (11.6)	504 (19.8)	90 (3.54)	53 (117)

Note

The build in length (D) depends on the process connector.

15.2 Lengths matrix

316L stainless steel - standard

Table 15-2 7ME461 - sensor sizes DN15 and DN25

Sensor	DN15					DN25		
	DN6	DN10	DN15	DN20	DN25	DN25	DN32	DN40
EN1092-1 B1, PN16			265		265	360		365
EN1092-1 B1, PN40			265		265	360		365
EN1092-1 B1, PN63			265			360		
EN1092-1 B1, PN100			270		275	360		365
ANSI B16.5-2009, Class 150			270	270		360		365
ANSI B16.5-2009, Class 300			270	270		360		380
ANSI B16.5-2009, Class 600			270	285		360		380
ISO228-1 G parallel pipe thread	265		265			365		
ANSI B1.20.1 NPT pipe thread	265		270			365		
DIN 11851 Hygienic screwed		265	265			360	360	
DIN32676-C Hygienic clamp			265	265		360		360
DIN11864-1 Aseptic screwed			265			360		
DIN11864-2 Aseptic flanged			265			360		
ISO 2852 Hygienic clamped					265	360		
ISO 2853 Hygienic screwed					265	360		

Dimensions in mm

Table 15-3 7ME461 - sensor sizes DN50 and DN80

Sensor	DN50		DN80		
	DN40	DN50	DN65	DN80	DN100
EN1092-1 B1, PN16	610	610	915	840	840
EN1092-1 B1, PN40	610	610	915	840	840
EN1092-1 B1, PN63	610	610	915	915	915
EN1092-1 B1, PN100	610	610	915	915	915
ANSI B16.5-2009, Class 150		620	915	875	
ANSI B16.5-2009, Class 300		620	915	875	
ANSI B16.5-2009, Class 600		620	915	875	
ISO228-1 GH pipe thread		620			
ANSI B1.20.1 NPT pipe thread		620			
DIN 11851 Hygienic screwed	610	610	840	840	
DIN32676-C Hygienic clamp		610		875	
DIN11864-1 Aseptic screwed		610		875	
DIN11864-2 Aseptic flanged	620	610		875	

ISO 2852 Hygienic clamped	610	610		840	
ISO 2853 Hygienic screwed		610		860	

Dimensions in mm

316L stainless steel - NAMUR

Table 15-4 7ME471 - sensor sizes DN15 and DN25

Sensor	DN15					DN25		
	DN6	DN10	DN15	DN20	DN25	DN25	DN32	DN40
EN1092-1 B1, PN16			510		510	600		
EN1092-1 B1, PN40			510		510	600		
EN1092-1 B1, PN63			510			600		
EN1092-1 B1, PN100						600		
EN1092-1 D, PN40			510			600		
EN1092-1 D, PN63			510			600		
EN1092-1 D, PN100						600		
ANSI B16.5-2009, Class 150						600		
ANSI B16.5-2009, Class 300						600		
ANSI B16.5-2009, Class 600						600		
ISO228-1 GH pipe thread	510		510					
ANSI B1.20.1 NPT pipe thread	510							
DIN 11851 Hygienic screwed		510	510			600	600	
DIN32676 Hygienic clamp			510	510		600		600
DIN11864-1 Aseptic screwed			510			600		
DIN11864-2 Aseptic flanged								
ISO 2852 Hygienic clamp					510	600		
ISO 2853 Hygienic screwed					510	600		

Dimensions in mm

Table 15-5 7ME471 - sensor sizes DN50 and DN80

Sensor	DN50		DN80		
	DN40	DN50	DN65	DN80	DN100
EN1092-1 B1, PN16	715	715	915	915	915
EN1092-1 B1, PN40	715	715	915	915	915
EN1092-1 B1, PN63	715	715	915	915	915
EN1092-1 B1, PN100	715	715	915	915	915
EN1092-1 D, PN40	715	715		915	
EN1092-1 D, PN63	715	715		915	
EN1092-1 D, PN100	715	715		915	
ANSI B16.5-2009, Class 150			915		
ANSI B16.5-2009, Class 300			915		

Dimensions and weight

15.2 Lengths matrix

ANSI B16.5-2009, Class 600			915		
ISO228-1 GH pipe thread					
ANSI B1.20.1 NPT pipe thread					
DIN 11851 Hygienic screwed	715	715	915	915	
DIN32676 Hygienic clamp		715			
DIN11864-1 Aseptic screwed		715			
DIN11864-2 Aseptic flanged					
ISO 2852 Hygienic clamp	715	715		915	
ISO 2853 Hygienic screwed		715			

Dimensions in mm

316L stainless steel - hygienic version

Table 15-6 7ME462 - sensor sizes DN15 and DN25

Sensor	DN15				DN25		
	DN10	DN15	DN20	DN25	DN25	DN32	DN40
DIN 11851 hygienic screwed	265	265			360	360	
DIN32676 hygienic clamp		265	265		360		360
DIN11864-1 aseptic screwed		265			360		
DIN11864-2 aseptic flanged		265			360		
ISO 2852 hygienic clamp				265	360		
ISO 2853 hygienic screwed				265	360		

Dimensions in mm

Table 15-7 7ME462 - sensor sizes DN50 and DN80

Sensor	DN50		DN80	
	DN40	DN50	DN65	DN80
DIN 11851 hygienic screwed	610	610	840	840
DIN32676 hygienic clamp		610		875
DIN11864-1 aseptic screwed		610		875
DIN11864-2 aseptic flanged	620	610		875
ISO 2852 hygienic clamp	610	610		840
ISO 2853 hygienic screwed		610		860

Dimensions in mm

Note

3A

DIN 11851 and ISO 2853 are only 3A-approved if self-centring gaskets are used.

15.3 Transmitter dimensions

Compact version

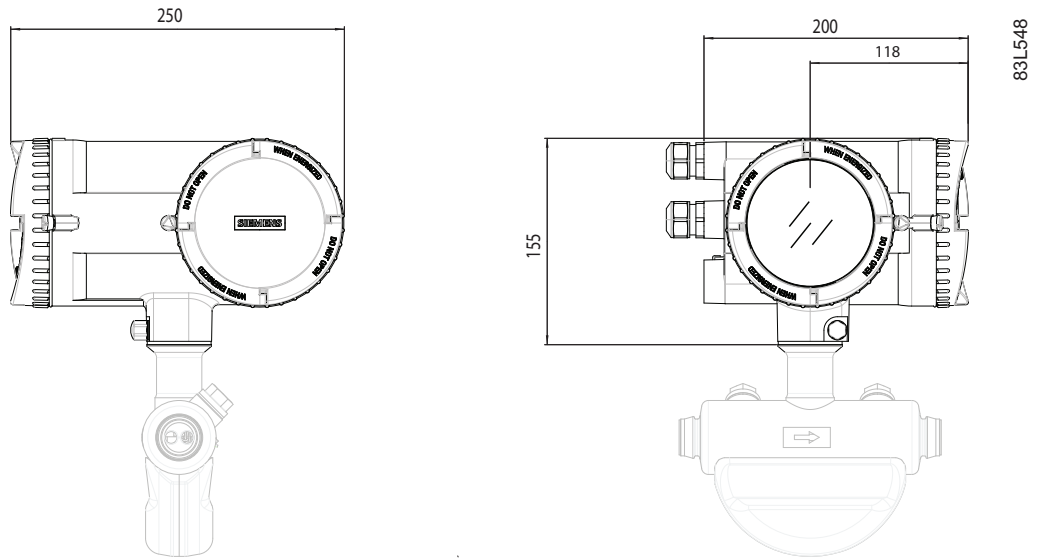

Remote version

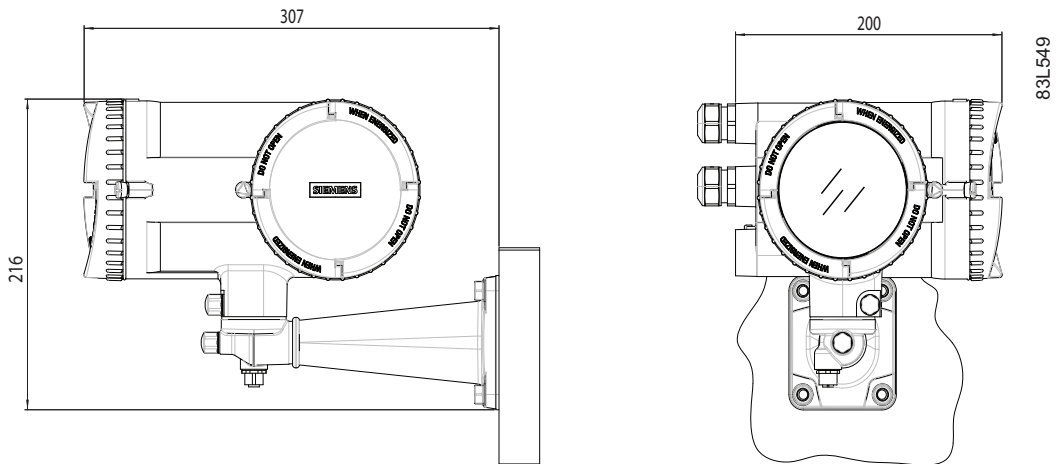

Weight: 4.8 kg (10.6 lbs)

15.4 Mounting bracket

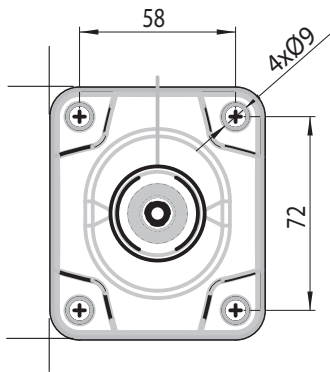

Figure 15-1 Mounting bracket dimensions

LUI menu structure

A.1 Menu structure overview

How to read the tables

In the following tables the menus are entered in **bold text** and the parameters in *italic*.

A.2 Main menu

In the following table only the menus and parameters of the first two levels of the LUI menu structure are listed.

Table A-1 Main menu

Level 1		Level 2		More information
No.	Name	No.	Name	
1	Quick Start	1.1	<i>Flow Direction</i>	
		1.2	<i>Process Noise Damping</i>	
		1.3	Massflow	Menu item 1.3: Massflow (Page 204)
		1.4	Volumeflow	Menu item 1.4: Volumeflow (Page 205)
		1.5	Density	Menu item 1.5: Density (Page 205)
		1.6	Fluid Temperature	Menu item 1.6: Fluid temperature (Page 205)
		1.7	Fraction	Menu item 1.7: Fraction (Page 205)
		1.8	Totalizer 1	Menu item 1.8: Totalizer 1 (Page 206)
		1.9	Totalizer 2	Menu item 1.9: Totalizer 2 (Page 206)
		1.10	Totalizer 3	Menu item 1.10: Totalizer 3 (Page 206)
		1.11	<i>Start Zero Point Adj.</i>	
2	Setup	2.1	Basic Settings	Menu item 2.1: Basic Settings (Page 207)
		2.2	Process Values	Menu item 2.2: Process Values (Page 207)
		2.3	Totalizer	Menu item 2.3: Totalizer (Page 209)
		2.4	Inputs/Outputs	Menu item 2.4: Inputs/Outputs (Page 210)
		2.5	Dosing	Menu item 2.5: Dosing (Page 214)
		2.6	Zero Point Adjustment	Menu item 2.6: Zero Point Adjustment (Page 217)
		2.7	Safe Operation	Menu item 2.7: Safe Operation (Page 217)

A.3 Menu item 1.3: Massflow

Level 1		Level 2		More information
No.	Name	No.	Name	
3	Maintenance & Diagnostics	2.8	Display	Menu item 2.8: Display (Page 218)
		3.1	Identification	Menu item 3.1: Identification (Page 219)
		3.2	Alarms	Menu item 3.2: Alarms (Page 220)
		3.3	Maintenance	Menu item 3.3: Maintenance (Page 220)
		3.4	Diagnostics	Menu item 3.4: Diagnostics (Page 221)
		3.5	Characteristics	Menu item 3.5: Characteristics (Page 221)
		3.6	SensorFlash	Menu item 3.6: SensorFlash (Page 222)
		3.7	Simulate	Menu item 3.7: Simulate (Page 222)
		3.8	Self Test	Menu item 3.8: Self Test (Page 224)
		3.9	Dosing Test	Menu item 3.9: Dosing Test (Page 224)
4	Communication	4.1	<i>Polling Address (SW)</i>	
		4.2	<i>Polling Address (HW)</i>	
		4.3	<i>TAG</i>	
		4.4	<i>HART Device Type</i>	
		4.5	<i>HART Revision</i>	
		4.6	Mapping of Variables	Menu item 4.6: Mapping of Variables (Page 224)
		4.7	HART Units	Menu item 4.7: HART Units (Page 225)
5	Security	5.1	Access Management	Menu item 5.1: Access Management (Page 225)
6	<i>Language</i>			

A.3 Menu item 1.3: Massflow

Table A-2 Massflow

Level 3		Level 4		Level 5	
No.	Name	No.	Name	No.	Name
1.3.1	<i>Unit</i>				
1.3.2	<i>Low Flow Cut-Off</i>				

A.4 Menu item 1.4: Volumeflow

Table A-3 Volumeflow

Level 3		Level 4		Level 5	
No.	Name	No.	Name	No.	Name
1.4.1	<i>Unit</i>				
1.4.2	<i>Low Flow Cut-Off</i>				

A.5 Menu item 1.5: Density

Table A-4 Density

Level 3		Level 4		Level 5	
No.	Name	No.	Name	No.	Name
1.5.1	<i>Unit</i>				
1.5.2	<i>Empty Tube Detection</i>				
1.5.3	<i>Empty Tube Limit</i>				

A.6 Menu item 1.6 Fluid temperature

Table A-5 Fluid Temperature

Level 3		Level 4		Level 5	
No.	Name	No.	Name	No.	Name
1.6.1	<i>Unit</i>				

A.7 Menu item 1.7: Fraction

Table A-6 Fraction

Level 3		Level 4		Level 5	
No.	Name	No.	Name	No.	Name
1.7.1	<i>Measurement Mode</i>				
1.7.2	<i>Unit</i>				
1.7.3	<i>Unit</i>				

A.8 Menu item 1.8: Totalizer 1

Table A-7 Totalizer 1

Level 3		Level 4		Level 5	
No.	Name	No.	Name	No.	Name
1.8.1	Process Value				
1.8.2	Unit				
1.8.3	Direction				
1.8.4	Fail Safe Mode				

A.9 Menu item 1.9: Totalizer 2

Table A-8 Totalizer 2

Level 3		Level 4		Level 5	
No.	Name	No.	Name	No.	Name
1.9.1	Process Value				
1.9.2	Unit				
1.9.3	Direction				
1.9.4	Fail Safe Mode				

A.10 Menu item 1.10: Totalizer 3

Table A-9 Totalizer 3

Level 3		Level 4		Level 5	
No.	Name	No.	Name	No.	Name
1.10.1	Process Value				
1.10.2	Unit				
1.10.3	Direction				
1.10.4	Fail Safe Mode				

A.11 Menu item 2.1: Basic settings

Table A-10 Basic settings

Level 3		Level 4		Level 5	
No.	Name	No.	Name	No.	Name
2.1.1	<i>Flow Direction</i>				
2.1.2	<i>Process Noise Damping</i>				

A.12 Menu item 2.2: Process values

Table A-11 Process values

Level 3		Level 4		Level 5	
No.	Name	No.	Name	No.	Name
2.2.1	Massflow	2.2.1.1	<i>Unit</i>		
		2.2.1.2	<i>Low Flow Cut-Off</i>		
		2.2.1.3	<i>Upper Limit Alarm</i>		
		2.2.1.4	<i>Upper Limit Warning</i>		
		2.2.1.5	<i>Lower Limit Warning</i>		
		2.2.1.6	<i>Lower Limit Alarm</i>		
		2.2.1.7	<i>Alarm Hysteresis</i>		
2.2.2	Volumeflow	2.2.2.1	<i>Unit</i>		
		2.2.2.2	<i>Low Flow Cut-Off</i>		
		2.2.2.3	<i>Upper Limit Alarm</i>		
		2.2.2.4	<i>Upper Limit Warning</i>		
		2.2.2.5	<i>Lower Limit Warning</i>		
		2.2.2.6	<i>Lower Limit Alarm</i>		
		2.2.2.7	<i>Alarm Hysteresis</i>		
2.2.3	Corrected Volumeflow	2.2.3.1	<i>Unit</i>		
		2.2.3.2	<i>Upper Limit Alarm</i>		
		2.2.3.3	<i>Upper Limit Warning</i>		
		2.2.3.4	<i>Lower Limit Warning</i>		
		2.2.3.5	<i>Lower Limit Alarm</i>		
		2.2.3.6	<i>Alarm Hysteresis</i>		
		2.2.3.7	Reference Density	2.2.3.7.1	<i>Unit</i>
				2.2.3.7.2	<i>Corrected Volumeflow Mode</i>
				2.2.3.7.3	<i>Fixed Reference Density</i>
				2.2.3.7.4	<i>Linear Expansion Coeff.</i>
				2.2.3.7.5	<i>Square Expansion Coeff.</i>
				2.2.3.7.6	<i>Reference Temperature</i>

LUI menu structure

A.12 Menu item 2.2: Process values

Level 3		Level 4		Level 5			
No.	Name	No.	Name	No.	Name		
				2.2.3.7.7	Upper Limit Alarm		
				2.2.3.7.8	Upper Limit Warning		
				2.2.3.7.9	Lower Limit Warning		
				2.2.3.7.10	Lower Limit Alarm		
				2.2.3.7.11	Alarm Hysteresis		
2.2.4	Flow Adjustment	2.2.4.1	Adjustment Factor				
2.2.5	Density	2.2.5.1	Unit				
		2.2.5.2	Empty Tube Detection				
		2.2.5.3	Empty Tube Limit				
		2.2.5.4	Upper Limit Alarm				
		2.2.5.5	Upper Limit Warning				
		2.2.5.6	Lower Limit Warning				
		2.2.5.7	Lower Limit Alarm				
		2.2.5.8	Alarm Hysteresis				
		2.2.5.9	Density Adjustment	2.2.5.9.1	Adjustment Factor		
				2.2.5.9.2	Adjustment Offset		
2.2.6	Fluid Temperature	2.2.6.1	Unit				
		2.2.6.2	Upper Limit Alarm				
		2.2.6.3	Upper Limit Warning				
		2.2.6.4	Lower Limit Warning				
		2.2.6.5	Lower Limit Alarm				
		2.2.6.6	Alarm Hysteresis				
2.2.7	Fraction	2.2.7.1	Measurement Mode				
		2.2.7.2	Unit				
		2.2.7.3	Fraction A	2.2.7.3.1	Fraction A Text		
				2.2.7.3.2	Upper Limit Alarm		
				2.2.7.3.3	Upper Limit Warning		
				2.2.7.3.4	Lower Limit Warning		
				2.2.7.3.5	Lower Limit Alarm		
				2.2.7.3.6	Alarm Hysteresis		
		2.2.7.4	Fraction B	2.2.7.4.1	Fraction B Text		
				2.2.7.4.2	Upper Limit Alarm		
				2.2.7.4.3	Upper Limit Warning		
				2.2.7.4.4	Lower Limit Warning		
				2.2.7.4.5	Lower Limit Alarm		
				2.2.7.4.6	Alarm Hysteresis		
		2.2.7.5	Fraction A %	2.2.7.5.1	Upper Limit Alarm		
2.2.7.5.2	Upper Limit Warning						
2.2.7.5.3	Lower Limit Warning						
2.2.7.5.4	Lower Limit Alarm						
2.2.7.5.5	Alarm Hysteresis						
2.2.7.6	Fraction B %	2.2.7.6.1	Upper Limit Alarm				

Level 3		Level 4		Level 5	
No.	Name	No.	Name	No.	Name
				2.2.7.6.2	Upper Limit Warning
				2.2.7.6.3	Lower Limit Warning
				2.2.7.6.4	Lower Limit Alarm
				2.2.7.6.5	Alarm Hysteresis
		2.2.7.7	Fraction Adjustment	2.2.7.7.1	Adjustment Factor
				2.2.7.7.2	Adjustment Offset

A.13 Menu item 2.3: Totalizer

Table A-12 Totalizers

Level 3		Level 4		Level 5	
No.	Name	No.	Name	No.	Name
2.3.1	Totalizer 1	2.3.1.1	Process Value		
		2.3.1.2	Unit		
		2.3.1.3	Direction		
		2.3.1.4	Fail Safe Mode		
		2.3.1.5	Upper Limit Alarm		
		2.3.1.6	Upper Limit Warning		
		2.3.1.7	Lower Limit Warning		
		2.3.1.8	Lower Limit Alarm		
		2.3.1.9	Alarm Hysteresis		
		2.3.1.10	Reset		
2.3.2	Totalizer 2	2.3.2.1	Process Value		
		2.3.2.2	Unit		
		2.3.2.3	Direction		
		2.3.2.4	Fail Safe Mode		
		2.3.2.5	Upper Limit Alarm		
		2.3.2.6	Upper Limit Warning		
		2.3.2.7	Lower Limit Warning		
		2.3.2.8	Lower Limit Alarm		
		2.3.2.9	Alarm Hysteresis		
		2.3.2.10	Reset		
2.3.3	Totalizer 3	2.3.3.1	Process Value		
		2.3.3.2	Unit		
		2.3.3.3	Direction		
		2.3.3.4	Fail Safe Mode		
		2.3.3.5	Upper Limit Alarm		
		2.3.3.6	Upper Limit Warning		

A.14 Menu item 2.4: Inputs/Outputs

Level 3		Level 4		Level 5	
No.	Name	No.	Name	No.	Name
		2.3.3.7	Lower Limit Warning		
		2.3.3.8	Lower Limit Alarm		
		2.3.3.9	Alarm Hysteresis		
		2.3.3.10	Reset		
2.3.4	Reset All Totalizers				

A.14 Menu item 2.4: Inputs/Outputs

Table A-13 Current output on channel 1

Level 3		Level 4		Level 5	
No.	Name	No.	Name	No.	Name
2.4.1	Current Output (1)	2.4.1.1	Process Value		
		2.4.1.2	HART Mode		
		2.4.1.3	Direction		
		2.4.1.4	Current Mode		
		2.4.1.5	Upper Scaling		
		2.4.1.6	Lower Scaling		
		2.4.1.7	Filter Time Constant		
		2.4.1.8	Fail Safe Mode		
		2.4.1.9	Fail Safe Value		

Table A-14 Signal output on channel 2

Level 3		Level 4		Level 5	
No.	Name	No.	Name	No.	Name
2.4.2	Signal Output (2)	2.4.2.1	Operation Mode		
		2.4.2.2	Process Value		
		2.4.2.3	Direction		
		2.4.2.4	Current Mode		
		2.4.2.5	Upper Scaling		
		2.4.2.6	Lower Scaling		
		2.4.2.7	Filter Time Constant		
		2.4.2.8	Fail Safe Mode		
		2.4.2.9	Fail Safe Value		
		2.4.2.10	Process Value		
		2.4.2.11	Direction		
		2.4.2.12	Frequency Value High		
		2.4.2.13	Frequency Value Low		
		2.4.2.14	Flow Value High		

Level 3		Level 4		Level 5	
No.	Name	No.	Name	No.	Name
		2.4.2.15	Flow Value Low		
		2.4.2.16	Filter Time Constant		
		2.4.2.17	Fail Safe Mode		
		2.4.2.18	Fail Safe Value		
		2.4.2.19	Process Value		
		2.4.2.20	Direction		
		2.4.2.21	Pulse Width		
		2.4.2.22	Pulse Unit		
		2.4.2.23	Amount Per Pulse		
		2.4.2.24	Polarity		
		2.4.2.25	Fail Safe Mode		
		2.4.2.26	Status Mode		
		2.4.2.27	Alarm		
		2.4.2.28	Alarm Class		
		2.4.2.29	Alarm Class		
		2.4.2.30	Polarity		
		2.4.2.31	On Delay		
		2.4.2.32	Off Delay		

Table A-15 Signal output on channel 3

Level 3		Level 4		Level 5	
No.	Name	No.	Name	No.	Name
2.4.3	Signal Output (3)	2.4.3.1	Operation Mode		
		2.4.3.2	Process Value		
		2.4.3.3	Direction		
		2.4.3.4	Current Mode		
		2.4.3.5	Upper Scaling		
		2.4.3.6	Lower Scaling		
		2.4.3.7	Filter Time Constant		
		2.4.3.8	Fail Safe Mode		
		2.4.3.9	Fail Safe Value		
		2.4.3.10	Redundancy Mode		
		2.4.3.11	Process Value		
		2.4.3.12	Direction		
		2.4.3.13	Frequency Value High		
		2.4.3.14	Frequency Value Low		
		2.4.3.15	Flow Value High		
		2.4.3.16	Flow Value Low		
		2.4.3.17	Filter Time Constant		
		2.4.3.18	Fail Safe Mode		
		2.4.3.19	Fail Safe Value		

LUI menu structure

A.14 Menu item 2.4: Inputs/Outputs

Level 3		Level 4		Level 5	
No.	Name	No.	Name	No.	Name
		2.4.3.20	Redundancy Mode		
		2.4.3.21	Process Value		
		2.4.3.22	Direction		
		2.4.3.23	Pulse Width		
		2.4.3.24	Pulse Unit		
		2.4.3.25	Amount Per Pulse		
		2.4.3.26	Polarity		
		2.4.3.27	Fail Safe Mode		
		2.4.3.28	Status Mode		
		2.4.3.29	Alarm		
		2.4.3.30	Alarm Class		
		2.4.3.31	Alarm Class		
		2.4.3.32	Polarity		
		2.4.3.33	On Delay		
		2.4.3.34	Off Delay		

Table A-16 Relay output on channel 3

Level 3		Level 4		Level 5	
No.	Name	No.	Name	No.	Name
2.4.4	Relay Output (3)	2.4.4.1	Status Mode		
		2.4.4.2	Alarm		
		2.4.4.3	Alarm Class		
		2.4.4.4	Alarm Class		
		2.4.4.5	Polarity		
		2.4.4.6	On Delay		
		2.4.4.7	Off Delay		

Table A-17 Signal Input on channel 3

Level 3		Level 4		Level 5	
No.	Name	No.	Name	No.	Name
2.4.5	Signal Input (3)	2.4.5.1	Operation Mode		
		2.4.5.2	Delay Time		
		2.4.5.3	Polarity		

Table A-18 Signal output on channel 4

Level 3		Level 4		Level 5	
No.	Name	No.	Name	No.	Name
2.4.6	Signal Output (4)	2.4.6.1	Operation Mode		
		2.4.6.2	Process Value		
		2.4.6.3	Direction		

Level 3		Level 4		Level 5	
No.	Name	No.	Name	No.	Name
		2.4.6.4	Current Mode		
		2.4.6.5	Upper Scaling		
		2.4.6.6	Lower Scaling		
		2.4.6.7	Filter Time Constant		
		2.4.6.8	Fail Safe Mode		
		2.4.6.9	Fail Safe Value		
		2.4.6.10	Process Value		
		2.4.6.11	Direction		
		2.4.6.12	Frequency Value High		
		2.4.6.13	Frequency Value Low		
		2.4.6.14	Flow Value High		
		2.4.6.15	Flow Value Low		
		2.4.6.16	Filter Time Constant		
		2.4.6.17	Fail Safe Mode		
		2.4.6.18	Fail Safe Value		
		2.4.6.19	Process Value		
		2.4.6.20	Direction		
		2.4.6.21	Pulse Width		
		2.4.6.22	Pulse Unit		
		2.4.6.23	Amount Per Pulse		
		2.4.6.24	Polarity		
		2.4.6.25	Fail Safe Mode		
		2.4.6.26	Status Mode		
		2.4.6.27	Alarm		
		2.4.6.28	Alarm Class		
		2.4.6.29	Alarm Class		
		2.4.6.30	Polarity		
		2.4.6.31	On Delay		
		2.4.6.32	Off Delay		

Table A-19 Relay output on channel 4

Level 3		Level 4		Level 5	
No.	Name	No.	Name	No.	Name
2.4.7	Relay Output (4)	2.4.7.1	Status Mode		
		2.4.7.2	Alarm		
		2.4.7.3	Alarm Class		
		2.4.7.4	Alarm Class		
		2.4.7.5	Polarity		
		2.4.7.6	On Delay		
		2.4.7.7	Off Delay		

A.15 Menu item 2.5: Dosing

Table A-20 Signal Input on channel 4

Level 3		Level 4		Level 5	
No.	Name	No.	Name	No.	Name
2.4.8	Signal Input (4)	2.4.8.1	Operation Mode		
		2.4.8.2	Delay Time		
		2.4.8.3	Polarity		

A.15 Menu item 2.5: Dosing

Table A-21 Dosing

Level 3		Level 4		Level 5	
No.	Name	No.	Name	No.	Name
2.5.1	Dosing Mode				
2.5.2	Process Value				
2.5.3	Active Recipe				

Table A-22 Recipe 1

Level 3		Level 4		Level 5			
No.	Name	No.	Name	No.	Name		
2.5.4	Recipe 1	2.5.4.1	Name				
		2.5.4.2	Unit				
		2.5.4.3	Amount				
		2.5.4.4	Fix Compensation				
		2.5.4.5	Valve Control	2.5.4.5.1	Stage Setup Format		
				2.5.4.5.2	Stage 1 Primary Open		
				2.5.4.5.3	Stage 1 Primary Close		
				2.5.4.5.4	Stage 2 Secondary Open		
				2.5.4.5.5	Stage 2 Secondary Close		
				2.5.4.5.6	Fully Closed Current Level		
				2.5.4.5.7	Partially Open Current Level		
				2.5.4.5.8	Fully Open Current Level		
				2.5.4.5.9	Fully Open		
				2.5.4.5.10	Partially Closed		
2.5.4.6	Fault Handling	2.5.4.6.1	Duration Mode				
		2.5.4.6.2	Duration Time				
		2.5.4.6.3	Overrun Mode				
		2.5.4.6.4	Overrun Value				

Table A-23 Recipe 2

Level 3		Level 4		Level 5			
No.	Name	No.	Name	No.	Name		
2.5.5	Recipe 2	2.5.5.1	Name				
		2.5.5.2	Unit				
		2.5.5.3	Amount				
		2.5.5.4	Fix Compensation				
		2.5.5.5	Valve Control	2.5.5.5.1	Stage Setup Format		
				2.5.5.5.2	Stage 1 Primary Open		
				2.5.5.5.3	Stage 1 Primary Close		
				2.5.5.5.4	Stage 2 Secondary Open		
				2.5.5.5.5	Stage 2 Secondary Close		
				2.5.5.5.6	Fully Closed Current Level		
				2.5.5.5.7	Partially Open Current Level		
				2.5.5.5.8	Fully Open Current Level		
				2.5.5.5.9	Fully Open		
				2.5.5.5.10	Partially Closed		
		2.5.5.6	Fault Handling	2.5.5.6.1	Duration Mode		
2.5.5.6.2	Duration Time						
2.5.5.6.3	Overrun Mode						
2.5.5.6.4	Overrun Value						

Table A-24 Recipe 3

Level 3		Level 4		Level 5			
No.	Name	No.	Name	No.	Name		
2.5.6	Recipe 3	2.5.6.1	Name				
		2.5.6.2	Unit				
		2.5.6.3	Amount				
		2.5.6.4	Fix Compensation				
		2.5.6.5	Valve Control	2.5.6.5.1	Stage Setup Format		
				2.5.6.5.2	Stage 1 Primary Open		
				2.5.6.5.3	Stage 1 Primary Close		
				2.5.6.5.4	Stage 2 Secondary Open		
				2.5.6.5.5	Stage 2 Secondary Close		
				2.5.6.5.6	Fully Closed Current Level		
				2.5.6.5.7	Partially Open Current Level		
				2.5.6.5.8	Fully Open Current Level		
				2.5.6.5.9	Fully Open		

LUI menu structure

A.15 Menu item 2.5: Dosing

Level 3		Level 4		Level 5	
No.	Name	No.	Name	No.	Name
				2.5.6.5.10	Partially Closed
		2.5.6.6	Fault Handling	2.5.6.6.1	Duration Mode
				2.5.6.6.2	Duration Time
				2.5.6.6.3	Overrun Mode
				2.5.6.6.4	Overrun Value

Table A-25 Recipe 4

Level 3		Level 4		Level 5	
No.	Name	No.	Name	No.	Name
2.5.7	Recipe 4	2.5.7.1	Name		
		2.5.7.2	Unit		
		2.5.7.3	Amount		
		2.5.7.4	Fix Compensation		
		2.5.7.5	Valve Control	2.5.7.5.1	Stage Setup Format
				2.5.7.5.2	Stage 1 Primary Open
				2.5.7.5.3	Stage 1 Primary Close
				2.5.7.5.4	Stage 2 Secondary Open
				2.5.7.5.5	Stage 2 Secondary Close
				2.5.7.5.6	Fully Closed Current Level
				2.5.7.5.7	Partially Open Current Level
				2.5.7.5.8	Fully Open Current Level
				2.5.7.5.9	Fully Open
				2.5.7.5.10	Partially Closed
		2.5.7.6	Fault Handling	2.5.7.6.1	Duration Mode
				2.5.7.6.2	Duration Time
				2.5.7.6.3	Overrun Mode
				2.5.7.6.4	Overrun Value

Table A-26 Recipe 5

Level 3		Level 4		Level 5	
No.	Name	No.	Name	No.	Name
2.5.8	Recipe 5	2.5.8.1	Name		
		2.5.8.2	Unit		
		2.5.8.3	Amount		
		2.5.8.4	Fix Compensation		
		2.5.8.5	Valve Control	2.5.8.5.1	Stage Setup Format
				2.5.8.5.2	Stage 1 Primary Open
				2.5.8.5.3	Stage 1 Primary Close

Level 3		Level 4		Level 5	
No.	Name	No.	Name	No.	Name
				2.5.8.5.4	Stage 2 Secondary Open
				2.5.8.5.5	Stage 2 Secondary Close
				2.5.8.5.6	Fully Closed Current Level
				2.5.8.5.7	Partially Open Current Level
				2.5.8.5.8	Fully Open Current Level
				2.5.8.5.9	Fully Open
				2.5.8.5.10	Partially Closed
		2.5.8.6	Fault Handling	2.5.8.6.1	Duration Mode
				2.5.8.6.2	Duration Time
				2.5.8.6.3	Overrun Mode
				2.5.8.6.4	Overrun Value

A.16 Menu item 2.6: Zero point adjustment

Table A-27 Zero point adjustment

Level 3		Level 4		Level 5	
No.	Name	No.	Name	No.	Name
2.5.1	Select Zero Point Adj.				
2.5.2	Start Zero Point Adj.				
2.5.3	Duration				
2.5.4	Standard Deviation Limit				
2.5.5	Standard Deviation				
2.5.6	Offset Limit				
2.5.7	Offset				
2.5.8	Offset				

A.17 Menu item 2.7: Safe operation

Table A-28 Safe Operation

Level 3		Level 4		Level 5	
No.	Name	No.	Name	No.	Name
2.7.1	SIL Operation Mode				
2.7.2	Enter Safe Configuration				

A.18 Menu item 2.8: Display

Level 3		Level 4		Level 5	
No.	Name	No.	Name	No.	Name
2.7.3	Start Safety Validation				
2.7.4	Safety Validation				
2.7.5	Confirm Safety Validation				
2.7.6	Modify Safe Configuration				
2.7.7	Enter Non-Safe Operation				
2.7.8	Acknowledge Safety Alarms				

A.18 Menu item 2.8: Display

Table A-29 Display

Level 3		Level 4		Level 5	
No.	Name	No.	Name	No.	Name
2.8.1	Backlight				
2.8.2	Contrast				
2.8.3	View 1	2.8.3.1	View		
		2.8.3.2	1st Process Value		
		2.8.3.3	2nd Process Value		
		2.8.3.4	3rd Process Value		
		2.8.3.5	4th Process Value		
		2.8.3.6	5th Process Value		
		2.8.3.7	6th Process Value		
2.8.4	View 2	2.8.4.1	Enable or disable		
		2.8.4.2	View		
		2.8.4.3	1st Process Value		
		2.8.4.4	2nd Process Value		
		2.8.4.5	3rd Process Value		
		2.8.4.6	4th Process Value		
		2.8.4.7	5th Process Value		
		2.8.4.8	6th Process Value		
2.8.5	View 3	2.8.5.1	Enable or disable		
		2.8.5.2	View		
		2.8.5.3	1st Process Value		
		2.8.5.4	2nd Process Value		
		2.8.5.5	3rd Process Value		
		2.8.5.6	4th Process Value		
		2.8.5.7	5th Process Value		
		2.8.5.8	6th Process Value		
2.8.6	View 4	2.8.6.1	Enable or disable		

Level 3		Level 4		Level 5	
No.	Name	No.	Name	No.	Name
		2.8.6.2	View		
		2.8.6.3	1st Process Value		
		2.8.6.4	2nd Process Value		
		2.8.6.5	3rd Process Value		
		2.8.6.6	4th Process Value		
		2.8.6.7	5th Process Value		
		2.8.6.8	6th Process Value		
2.8.7	View 5	2.8.7.1	Enable or disable		
		2.8.7.2	View		
		2.8.7.3	1st Process Value		
		2.8.7.4	2nd Process Value		
		2.8.7.5	3rd Process Value		
		2.8.7.6	4th Process Value		
		2.8.7.7	5th Process Value		
		2.8.7.8	6th Process Value		
2.8.8	View 6	2.8.8.1	Enable or disable		
		2.8.8.2	View		
		2.8.8.3	1st Process Value		
		2.8.8.4	2nd Process Value		
		2.8.8.5	3rd Process Value		
		2.8.8.6	4th Process Value		
		2.8.8.7	5th Process Value		
		2.8.8.8	6th Process Value		

A.19 Menu item 3.1: Identification

Table A-30 Identification

Level 3		Level 4		Level 5	
No.	Name	No.	Name	No.	Name
3.1.1	Long TAG				
3.1.2	Descriptor				
3.1.3	Message				
3.1.4	Location				
3.1.5	Date				
3.1.6	Manufacturer				
3.1.7	Product Name				
3.1.8	Version				
3.1.9	System Order Number				

LUI menu structure

A.21 Menu item 3.3: Maintenance

Level 3		Level 4		Level 5	
No.	Name	No.	Name	No.	Name
3.1.10	System Firmware Revision				
3.1.11	Final Assembly Number				
3.1.12	Transmitter	3.1.12.1	Order Number		
		3.1.12.2	Serial Number		
		3.1.12.3	Firmware Revision		
		3.1.12.4	Hardware Revision		
		3.1.12.5	LUI Firmware Revision		
		3.1.12.6	LUI Hardware Revision		
3.1.13	Sensor	3.1.13.1	Type		
		3.1.13.2	Size		
		3.1.13.3	Order Number		
		3.1.13.4	Serial Number		
		3.1.13.5	Firmware Revision		
		3.1.13.6	Hardware Revision		

A.20 Menu item 3.2: Alarms

Table A-31 Alarms

Level 3		Level 4		Level 5	
No.	Name	No.	Name	No.	Name
3.2.1	Alarm Mode				
3.2.2	Alarm				
3.2.3	Alarm History Log				
3.2.4	Reset History				

A.21 Menu item 3.3: Maintenance

Table A-32 Maintenance

Level 3		Level 4		Level 5	
No.	Name	No.	Name	No.	Name
3.3.1	Current Date and Time				
3.3.2	Set Date and Time				
3.3.3	Set To Default				
3.3.4	Restart Device				
3.3.5	Transmitter	3.3.5.1	Operating Time Total		

Level 3		Level 4		Level 5	
No.	Name	No.	Name	No.	Name
		3.3.5.2	<i>Operating Time</i>		
3.3.6	Sensor	3.3.6.1	<i>Operating Time Total</i>		
		3.3.6.2	<i>Operating Time</i>		

A.22 Menu item 3.4: Diagnostics

Table A-33 Diagnostics

Level 3		Level 4		Level 5	
No.	Name	No.	Name	No.	Name
3.4.1	<i>Current Output Value (1)</i>				
3.4.2	<i>Driver Current</i>				
3.4.3	<i>Driver Gain</i>				
3.4.4	<i>Pickup S1 Amplitude</i>				
3.4.5	<i>Pickup S2 Amplitude</i>				
3.4.6	<i>Sensor Frequency</i>				
3.4.7	<i>Fluid Temperature</i>				
3.4.8	<i>Frame Temperature</i>				
3.4.9	<i>Transm. Internal Temp.</i>				
3.4.10	<i>Offset</i>				
3.4.11	<i>Offset</i>				

A.23 Menu item 3.5: Characteristics

Table A-34 Characteristics

Level 3		Level 4		Level 5	
No.	Name	No.	Name	No.	Name
3.5.1	Transmitter	3.5.1.1	<i>Design</i>		
		3.5.1.2	<i>Hazardous Area Approval</i>		
3.5.2	Sensor	3.5.2.1	<i>Hazardous Area Approval</i>		
		3.5.2.2	<i>Maximum Massflow Capacity</i>		
		3.5.2.3	<i>Calibration Factor</i>		
		3.5.2.4	<i>Density Calibration Offset</i>		
		3.5.2.5	<i>Density Calibration Factor</i>		
		3.5.2.6	<i>Dens. Comp. Tube Temp.</i>		

A.25 Menu item 3.7: Simulate

Level 3		Level 4		Level 5	
No.	Name	No.	Name	No.	Name
		3.5.2.7	Dens. Comp. Frame Temp.		
		3.5.2.8	Wetted Materials		

A.24 Menu item 3.6: SensorFlash

Table A-35 SensorFlash

Level 3		Level 4		Level 5	
No.	Name	No.	Name	No.	Name
3.6.1	Installed				
3.6.2	Capacity Total				
3.6.3	Capacity Available				

A.25 Menu item 3.7: Simulate

Table A-36 Input/Outputs

Level 3		Level 4		Level 5	
No.	Name	No.	Name	No.	Name
3.7.1	Simulate Input/Outputs	3.7.1.1	Current Output (1)	3.7.1.1.1	Simulation
				3.7.1.1.2	Simulated Value
				3.7.1.1.3	Simulation
		3.7.1.2	Signal Output (2)	3.7.1.2.1	Simulation
				3.7.1.2.2	Simulated Value
				3.7.1.2.3	Simulation
				3.7.1.2.4	Simulated Value
				3.7.1.2.5	Simulation
				3.7.1.2.6	Simulated Value
				3.7.1.2.7	Simulation
				3.7.1.2.8	Simulated Value
		3.7.1.3	Signal Output (3)	3.7.1.3.1	Simulation
				3.7.1.3.2	Simulated Value
				3.7.1.3.3	Simulation
				3.7.1.3.4	Simulated Value
3.7.1.3.5	Simulation				
3.7.1.3.6	Simulated Value				
3.7.1.3.7	Simulation				
3.7.1.3.8	Simulated Value				

Level 3		Level 4		Level 5	
No.	Name	No.	Name	No.	Name
		3.7.1.4	Relay Output (3)	3.7.1.4.1	<i>Simulation</i>
				3.7.1.4.2	<i>Simulated Value</i>
		3.7.1.5	Signal Input (3)	3.7.1.5.1	<i>Simulation</i>
				3.7.1.5.2	<i>Simulated Value</i>
		3.7.1.6	Signal Output (4)	3.7.1.6.1	<i>Simulation</i>
				3.7.1.6.2	<i>Simulated Value</i>
				3.7.1.6.3	<i>Simulation</i>
				3.7.1.6.4	<i>Simulated Value</i>
				3.7.1.6.5	<i>Simulation</i>
				3.7.1.6.6	<i>Simulated Value</i>
				3.7.1.6.7	<i>Simulation</i>
				3.7.1.6.8	<i>Simulated Value</i>
		3.7.1.7	Relay Output (4)	3.7.1.7.1	<i>Simulation</i>
				3.7.1.7.2	<i>Simulated Value</i>
		3.7.1.8	Signal Input (4)	3.7.1.8.1	<i>Simulation</i>
				3.7.1.8.2	<i>Simulated Value</i>

Table A-37 Process Values

Level 3		Level 4		Level 5	
No.	Name	No.	Name	No.	Name
3.7.2	Simulation Process Values	3.7.2.1	Massflow	3.7.2.1.1	<i>Simulation</i>
				3.7.2.1.2	<i>Massflow Value</i>
		3.7.2.2	Volumeflow	3.7.2.2.1	<i>Simulation</i>
				3.7.2.2.2	<i>Volumeflow Value</i>
		3.7.2.3	Corrected Volumeflow	3.7.2.3.1	<i>Simulation</i>
				3.7.2.3.2	<i>Corrected Volumeflow Value</i>
		3.7.2.4	Density	3.7.2.4.1	<i>Simulation</i>
				3.7.2.4.2	<i>Density Value</i>
		3.7.2.5	Fluid Temperature	3.7.2.5.1	<i>Simulation</i>
				3.7.2.5.2	<i>Fluid Temperature Value</i>
		3.7.2.6	Frame Temperature	3.7.2.6.1	<i>Simulation</i>
				3.7.2.6.2	<i>Frame Temperature Value</i>
		3.7.2.7	Fraction	3.7.2.7.1	<i>Simulation</i>
				3.7.2.7.2	<i>Fraction A % Value</i>
				3.7.2.7.3	<i>Fraction B % Value</i>

A.28 Menu item 4.6: Mapping of variables

Table A-38 Alarm

Level 3		Level 4		Level 5	
No.	Name	No.	Name	No.	Name
3.7.3	Simulate Alarm	3.7.3.1	Simulation		
		3.7.3.3	Alarm Class		
		3.7.3.4	Alarm Class		

A.26 Menu item 3.8: Self test

Table A-39 Self Test

Level 3		Level 4		Level 5	
No.	Name	No.	Name	No.	Name
3.9.1	Display Test				

A.27 Menu item 3.9: Dosing test

Table A-40 Dosing test

Level 3		Level 4		Level 5	
No.	Name	No.	Name	No.	Name
3.10.1	Control Dosing				
3.10.2	Dosing Status				

A.28 Menu item 4.6: Mapping of variables

Table A-41 Mapping of Variables

Level 3		Level 4		Level 5	
No.	Name	No.	Name	No.	Name
4.6.1	SV Process Value				
4.6.2	TV Process Value				
4.6.3	QV Process Value				

A.29 Menu item 4.7: HART units

Table A-42 HART Units

Level 3		Level 4		Level 5	
No.	Name	No.	Name	No.	Name
4.7.1	<i>Massflow Unit</i>				
4.7.2	<i>Volumeflow Unit</i>				
4.7.3	<i>Corr. Volumeflow Unit</i>				
4.7.4	<i>Density Unit</i>				
4.7.5	<i>Fluid Temperature Unit</i>				
4.7.6	<i>Fraction Unit</i>				
4.7.7	<i>Fraction Unit</i>				
4.7.8	<i>Totalizer 1 Unit</i>				
4.7.9	<i>Totalizer 2 Unit</i>				
4.7.10	<i>Totalizer 3 Unit</i>				

A.30 Menu item 5.1: Access management

Table A-43 Access Management

Level 3		Level 4		Level 5	
No.	Name	No.	Name	No.	Name
5.1.1	<i>Change User PIN Code</i>				
5.1.2	<i>Change Expert PIN Code</i>				
5.1.3	<i>Reset PINs</i>				
5.1.4	<i>PUK</i>				

HART commands

B.1 Universal commands

The device supports the following universal commands:

Table B-1 Universal commands

Command number	Function
0	Read unique identifier
1	Read primary variable (PV)
2	Read current and range
3	Read current four variables
6	Write polling address
11	Read unique id byte with tag
12	Read message
13	Read tag, descriptor and date
14	Read PV sensor number
15	Read PV output information
16	Read final assembly number
17	Write message
18	Write tag, descriptor and date
19	Write final assembly number
20	Read long tag
21	Read unique identifier associated with long tag
22	Write long tag
38	Reset configuration changed flag
48	Read additional device status

B.2 Common practice commands

The device supports the following common practice commands:

Table B-2 Common practice commands

Command number	Function
33	Read device variables
34	Write damping value
35	Write range values
36	Set primary variable upper range value
37	Set primary variable lower range value
40	Enter/exit fixed current mode

HART commands

B.2 Common practice commands

Command number	Function
42	Perform device reset
43	Set (trim) PV zero
44	Write PV units
45	Trim DAC zero
46	Trim DAC gain
50	Read dynamic variable assignment
51	Write dynamic variable assignment
53	Write device variables unit
54	Read device variables information
59	Write number of response preambles
60	Read analog channel in percent of range
63	Read analog channel information
70	Read analog channel endpoint values

Zero point adjustment

In the following the automatic zero point adjustment function is described in detail.

Note

Preconditions

Before a zero point adjustment is initiated, the pipe must be flushed, filled and at an absolute flowrate of zero preferably also at operating pressure and temperature. Refer to "Zero point adjustment" via LUI (Page 74) or PDM (Page 89) for more details.

Note

Change of parameters during zero point adjustment

Do not change any other parameter during the zero point adjustment procedure.

Automatic zero point adjustment

SITRANS FC430 measures and calculates the correct zero point automatically.

The automatic zero point adjustment of the flowmeter is set by the following parameters:

- Zero Point Adjustment Period
- Start Zero Point Adjustment

When zero adjust is initiated by selecting "Start Zero Point Adjustment", the massflow values are acquired and totalized for the configured period (Zero Point Adjustment Period). The default zero point adjustment period (30 s.) is normally sufficient for a stable zero point measurement.

Note

Extremely low flow quantity

If the flow quantity is extremely small, extremely precise measurement is necessary. In this case, a long zero point adjustment period can be selected for improved zero point adjustment.

Zero point calculation

During zero point adjustment, an average value is automatically calculated using the following formula:

Zero Point Offset Value

Average of N flow values

$$\bar{x} \equiv \frac{\sum_{i=1}^N x_i}{N}$$

x_i is an instantaneous flow value sampled in the time domain

N = Number of samples during zero point adjustment

The offset value must be within the determined "Offset Limit" (menu item number 2.6.6).

Note

Exceeded zero point offset limit

If the offset value is greater than the configured limit, proceed as follows:

- Check that the tube is completely filled and that the flowrate is absolute zero.
 - Check the validity of the configured zero point offset limit.
 - Repeat the zero point adjustment.
-

Zero point standard deviation

After completion of the procedure, the standard deviation is calculated in accordance with the following formula:

Zero Point Standard Deviation

Standard deviation of N values

$$s \equiv \sqrt{\frac{\sum_{i=1}^N (x_i - \bar{x})^2}{N - 1}} = \sqrt{\frac{-N\bar{x}^2 + \sum_{i=1}^N x_i^2}{N - 1}}$$

The standard deviation contains important feedback on the homogeneity of the fluid, for example on the presence of bubbles or particles.

The standard deviation must be within the determined "Zero Point Standard Deviation Limit" (menu item number 2.6.4).

Note

Exceeded standard deviation limit

If the standard deviation is greater than the configured limit, proceed as follows:

- Check that the tube is completely filled and that the flow rate is absolute zero.
 - Check that the installation is vibration-free.
 - Check the validity of the configured standard deviation limit in parameter 2.6.4 "Standard deviation limit".
 - Repeat the zero point adjustment.
-

Successful automatic zero point adjustment

If the new zero point offset value is valid, it is automatically stored as the new zero point for the sensor. It remains stored in the case of a power failure.

Glossary

BRIX

Degrees Brix (symbol °Brix) is a measurement of the mass ratio of dissolved sugar to water in a liquid. A 25 °Bx solution is 25% (w/w), with 25 grams of sugar per 100 grams of solution.

Coriolis

The Coriolis effect is an apparent deflection of moving objects from a straight path when they are viewed from a rotating frame of reference. The effect is named after Gaspard-Gustave Coriolis, a French scientist who described it in 1835. The Coriolis effect is caused by the Coriolis force, which appears in the equation of motion of an object in a rotating frame of reference.

EHEDG

European Hygienic Engineering & Design Group was founded in 1989 to promote hygienic engineering in the European food industry. EHEDG provides practical guidance on hygienic engineering aspects of manufacturing safe and wholesome foods.

EMC

Electromagnetic compatibility (EMC) is the branch of electrical sciences which studies the unintentional generation, propagation and reception of electromagnetic energy with reference to the unwanted effects (Electromagnetic Interference, or EMI) that such energy may induce. The goal of EMC is the correct operation, in the same electromagnetic environment, of different equipment which use electromagnetic phenomena, and the avoidance of any interference effects.

Fraction

Fraction designates a proportional relation between an object part and the object whole. For example, the fraction $\frac{3}{4}$ represents three equal parts of a whole object, divided into four equal parts.

IP

An IP (Ingress Protection) number is used to specify the environmental protection rating of enclosures around electronic equipment. These ratings are determined by specific tests. The IP number is composed of two numbers, the first referring to the protection against solid objects and the second against liquids. The higher the number, the better the protection. For example, in IP67 the first Number (6) means that the device is totally protected against dust, and the second (7) that it is protected against the effect of immersion between 15cm and 1m

NAMUR

Normenarbeitsgemeinschaft für Meß- und Regeltechnik in der Chemischen Industrie (NAMUR). NAMUR is a group representing the interests of the chemical industry which create standards for instrumentation and electrical devices used in industrial plants.

PED

The Pressure Equipment Directive (97/23/EC) is the legislative framework on European level for equipment subject to a pressure hazard. It was adopted by the European Parliament and the European Council in May 1997 and has been obligatory throughout the European Union since May 2002.

Plato

Plato is a measure of the weight of sucrose dissolved in water. It is expressed in degrees (% by mass).

Zero point adjustment

In order to measure accurately with a measuring instrument it is important that zero and gain have been calibrated. All Coriolis sensors are calibrated before they are sent out to customers. However, Coriolis sensors are very sensitive, and several factors might move the zero point, e.g installation, pressure, temperature and even very small vibrations coming from the process. All these factors are customer specific and can't be simulated at the factory. Therefore Siemens recommends to carry out a zero point adjustment before use.

Index

A

- Access Management, 225
- Accuracy
 - Density, 177
 - Massflow, 177
 - Temperature, 177
- Alarms, 220
- Approval nameplate
 - Sensor, 15
 - Transmitter, 17

B

- Basic settings, 207

C

- Cable specifications, 54, 183
- CE mark, 20
- Certificates, 19
- Certificates and approvals, 186
- Characteristics, 221
- Commissioning
 - LUI, 72
 - Safety, 71
 - Steps, 72
- Compliance
 - European directives, 20
- Coriolis
 - Applications, 25
 - Measurement principle, 37
- Correct usage, (See improper device modifications)
- Cross talk, 46, 172
- Current output, 210
- Customer Support Hotline, 162

D

- Decontamination, 166
- Density, 205
- Design, 29
- Design, sensor, 180
- Design, transmitter, 181
- Designated use, 175

Device

- Description, 27
 - Design, 27
 - Identification, 12, 14, 15, 16, 17
- ## Diagnose
- with SIMATIC PDM, 169
- ## Diagnostics, 221
- ## Dimensions and weight, 197
- ## Display, 218
- ## Document history, 9
- ## Dosing, 214
- ## Dosing test, 224

E

- ## Electrical connection
- Cable specifications, 54
 - In hazardous area, 54
 - Safety, 53
 - Safety instructions, 53
- ## Empty tube monitoring, 116

F

- Flow direction, 42
- Fluid temperature, 205
- Fraction, 205

H

- Handling, 45
- HART
 - Modem, 36
 - Slave address switch, 34
- HART communication, 176
- HART Units, 225
- Hazardous area
 - Electrical connection, 54
 - Laws and directives, 19
- Hazardous locations
 - Approvals, 21
- Hot swappable, 195
- Hotline, 162

I

- Identification, 219

Identification nameplate

- Sensor, 12
- Transmitter, 16

Improper device modifications, 20

Installation

- Drop line, 44
- Gas, 42
- Incorrect, 172
- Indoor/outdoor, 39
- Inlet / Outlet conditions, 41
- Liquid, 42
- Location in the system, 41
- Mounting of sensor, 45
- Orienting the sensor, 43
- Pressure guard, 46
- Rotate transmitter, 50
- Safety instructions, 39
- Transmitter, 48
- Transmitter mounting, 50
- Upstream / Downstream, 41

Installation torques, 185

Internet

- Contact person, 162
- Support, 162

Items supplied, 10

L

Local display

- Turning, 52

Local user interface, 93

Low flow cut-off, 116, 172

M

Main menu, 203

Mains supply, 53

Maintenance, 161, 220

Mapping of Variables, 224

Massflow, 204

Mounting, (See Installation)

N

Navigation view, 104

O

Operation, 93

P

Parameter view, 110

PDM

- Zero point adjustment, 74, 89

Performance, 176

Power supply, 183

Pressure

- Pressure drop, 179
- Safety instructions, 39

Process noise damping, 117

Process values, 207

Process variables, 175

R

Rated operating conditions, 178

Recalibration, 161

Recipe 1, 214

Recipe 2, 215

Recipe 3, 215

Recipe 4, 216

Recipe 5, 216

Reference conditions, 176

Relay output, 212, 213

Repair, 165

Return procedures, 166

S

Safe Operation, 217

Safety

- Sensor installation, 39

Safety instructions

- Electrical connection, 53

Scope of delivery, 11

Self test, 224

Sensor orientation, (See Installation)

SensorFlash, 175, 222

Service, 162, 165

Service information, 161

Signal Input, 212, 214

Signal output, 210, 211, 212

Signal processing, 37

Simulate

- Alarm, 224
- Input/Outputs, 222
- Process Values, 223

Simulation, 139

Specification nameplate
 Sensor, 14
 Transmitter, 17
Support, 162
Symbols, (Refer to warning symbols)
System design, 175

T

Technical data, 175
Temperature specifications, 22
Test certificates, 19
Totalizer 1, 206
Totalizer 2, 206
Totalizer 3, 206
Totalizers, 209
Transmitter
 Mounting, 50
 Pipe mounting, 49
 Rotate transmitter, 50
 Wall mounting, 49

V

Vibrations, 45, 172
Volume flow, 205

W

Warning symbols, 19
Wire insulation, 53
Wiring, (See Electrical connection)

Z

Zero point adjustment, 75, 89, 115, 217, 229
 Automatic, 115, 229
 via PDM, 74, 89

For more information

www.siemens.com/flow

Siemens A/S
Flow Instruments
Nordborgvej 81
DK-6430 Nordborg

Subject to change without prior notice
Order No.: A5E03361511
Lit. No.: A5E03361511-03
© Siemens AG 06.2012

www.siemens.com/processautomation