

SIEMENS



SITRANS F

Coriolis flowmeters
SITRANS FC410

Operating Instructions

Edition

12/2013

Answers for industry.

SIEMENS

SITRANS F

Coriolis Flowmeters SITRANS FC410 with Modbus

Operating Instructions

Introduction	1
Safety notes	2
Description	3
Installing/Mounting	4
Connecting	5
Commissioning	6
Functions	7
Alarms and system messages	8
Service and maintenance	9
Troubleshooting/FAQs	10
Technical data	11
Spare parts and accessories	12
Dimensions and weight	13
Modbus holding registers	A
Sensor dimension dependent default settings	B
Zero point adjustment	C
CRC calculation	D
Exception codes	E
Float definition	F

These Operating Instructions apply to Siemens product SITRANS FC410 with order codes commencing 7ME4611, 7ME4621 and 7ME4711.

Legal information

Warning notice system

This manual contains notices you have to observe in order to ensure your personal safety, as well as to prevent damage to property. The notices referring to your personal safety are highlighted in the manual by a safety alert symbol, notices referring only to property damage have no safety alert symbol. These notices shown below are graded according to the degree of danger.

 DANGER
indicates that death or severe personal injury will result if proper precautions are not taken.

 WARNING
indicates that death or severe personal injury may result if proper precautions are not taken.

 CAUTION
indicates that minor personal injury can result if proper precautions are not taken.

NOTICE
indicates that property damage can result if proper precautions are not taken.

If more than one degree of danger is present, the warning notice representing the highest degree of danger will be used. A notice warning of injury to persons with a safety alert symbol may also include a warning relating to property damage.

Qualified Personnel

The product/system described in this documentation may be operated only by **personnel qualified** for the specific task in accordance with the relevant documentation, in particular its warning notices and safety instructions. Qualified personnel are those who, based on their training and experience, are capable of identifying risks and avoiding potential hazards when working with these products/systems.

Proper use of Siemens products

Note the following:

 WARNING
Siemens products may only be used for the applications described in the catalog and in the relevant technical documentation. If products and components from other manufacturers are used, these must be recommended or approved by Siemens. Proper transport, storage, installation, assembly, commissioning, operation and maintenance are required to ensure that the products operate safely and without any problems. The permissible ambient conditions must be complied with. The information in the relevant documentation must be observed.

Trademarks

All names identified by ® are registered trademarks of Siemens AG. The remaining trademarks in this publication may be trademarks whose use by third parties for their own purposes could violate the rights of the owner.

Disclaimer of Liability

We have reviewed the contents of this publication to ensure consistency with the hardware and software described. Since variance cannot be precluded entirely, we cannot guarantee full consistency. However, the information in this publication is reviewed regularly and any necessary corrections are included in subsequent editions.

Table of contents

1	Introduction	7
1.1	History	7
1.2	Items supplied	7
1.3	Checking the consignment.....	8
1.4	Device identification	9
1.5	Further Information	14
2	Safety notes	15
2.1	Laws and directives	15
2.2	CE declaration.....	16
2.3	Installation in hazardous locations	16
2.4	Certificates	19
3	Description	21
3.1	Design	22
3.2	System integration	23
3.3	Modbus RTU technology	23
3.4	Features	25
3.5	Theory of operation	25
4	Installing/Mounting	27
4.1	Introduction	27
4.2	Flowmeter installation	27
4.2.1	Installation safety precautions.....	27
4.2.2	Determining a location	29
4.2.3	Orientation of the device	30
4.2.4	Mounting the flowmeter.....	33
4.2.5	Hydrostatic testing	35
4.2.6	Mounting a pressure guard	35
5	Connecting	39
5.1	Wiring in hazardous locations	39
5.2	Cable requirements.....	39
5.3	Safety notes for connecting	40
5.4	Connecting the FC410	41
5.4.1	M12 version.....	41
5.4.2	Cable termination version	42
5.4.3	Setting the EOL termination DIP switches	44

5.5	Integrating the FC410 with Modbus system.....	45
5.5.1	System configurations.....	45
5.5.2	Wiring FC410 to the Modbus system.....	49
6	Commissioning	51
6.1	General requirements	51
6.2	Warnings	51
6.3	Operating via SIMATIC PDM	51
6.4	Functions in SIMATIC PDM	52
6.5	Commissioning steps	52
6.6	Initial setup	52
6.7	Adding device to communication network.....	54
6.8	Configuring a new device.....	55
6.9	Wizard - Quick Start via PDM	56
6.10	Wizard - Zero Point adjustment.....	62
6.11	Changing parameter settings using SIMATIC PDM	63
6.12	Parameters accessed via drop-down menus.....	64
6.13	Zero point adjustment	65
6.14	Process variables	67
7	Functions.....	69
7.1	Process values	69
7.2	Zero point adjustment	69
7.3	Low flow cut-off	72
7.4	Empty tube monitoring	72
7.5	Process noise damping.....	73
7.6	Totalizer.....	76
7.7	Access management.....	77
7.8	Simulation.....	77
7.9	Changing Modbus communication settings	78
7.10	Float transmission	78
8	Alarms and system messages.....	81
8.1	Alarm messages	81
9	Service and maintenance.....	83
9.1	Maintenance.....	83
9.2	Maintenance information parameters	83
9.3	Service information	83
9.4	Recalibration	84

9.5	Technical support.....	84
9.6	Transportation and storage.....	85
9.7	Device disposal.....	86
9.8	Maintenance work.....	86
10	Troubleshooting/FAQs	89
10.1	Diagnosing with PDM.....	89
10.2	Troubleshooting	89
10.2.1	Step 1: Inspecting the application	90
10.2.2	Step 2: Performing a zero point adjustment	90
10.2.3	Step 3: Calculating the measurement error	90
10.2.4	Step 4: Improving the application.....	92
11	Technical data	95
11.1	Function and system design	95
11.2	Process variables.....	95
11.3	Modbus Communication Specification.....	96
11.4	Performance.....	97
11.5	Rated operating conditions	98
11.6	Pressure drop curves.....	99
11.7	Pressure - temperature ratings	100
11.7.1	Stainless steel sensors	100
11.7.2	Hastelloy sensors.....	102
11.8	Design	103
11.9	Power supply.....	104
11.10	Cables and cable entries	104
11.11	Installation torques.....	105
11.12	Certificates and approvals	106
11.13	PED.....	106
11.13.1	Division according to the danger potential.....	107
11.13.2	Division of media (liquid/gaseous) into the fluid groups	108
11.13.3	Conformity assessment	109
11.13.4	Diagrams.....	110
12	Spare parts and accessories	113
12.1	Ordering	113
12.2	Ex approved products	113
12.3	Replaceable components	114
13	Dimensions and weight	115
13.1	Sensor dimensions	115
13.2	Length matrix	116

13.3	316L stainless steel - NAMUR	118
13.4	Hygienic versions	120
A	Modbus holding registers	121
A.1	Modbus addressing model	121
A.2	Modbus function codes	121
A.3	Modbus holding registers tables	126
A.3.1	Process values	127
A.3.2	Identification	127
A.3.3	Setup	129
A.3.4	Totalizer.....	131
A.3.5	Maintenance & Diagnostics.....	132
A.3.6	Communication	136
A.3.7	Characteristics	137
A.3.8	Simulation.....	139
A.3.9	Alarms	140
B	Sensor dimension dependent default settings	143
C	Zero point adjustment	145
D	CRC calculation	149
E	Exception codes	153
E.1	Exception handling.....	153
F	Float definition	155
F.1	Float definition.....	155
	Glossary	157
	Index	159

Introduction

These instructions contain all information required to commission and use the device. It is your responsibility to read the instructions carefully prior to installation and commissioning. In order to use the device correctly, first review its principle of operation.

The instructions are aimed at persons mechanically installing the device, connecting it electronically, configuring the parameters and commissioning it, as well as service and maintenance engineers.

The contents of this manual shall not become part of or modify any prior or existing agreement, commitment or legal relationship. The sales contract contains all obligations on the part of Siemens as well as the complete and solely applicable warranty conditions. Any statements regarding device versions described in the manual do not create new warranties or modify the existing warranty.

The content reflects the technical status at the time of publishing. Siemens reserves the right to make technical changes in the course of further development.

1.1 History

The following table shows major changes in the documentation compared to the previous edition.

Edition	Remarks	SW version	FW revision
12/2013	<ul style="list-style-type: none"> First edition 	<ul style="list-style-type: none"> SIMATIC PDM driver 1.00.01-01 	2.03.02-01

1.2 Items supplied

With M12 plug connection

- SITRANS FC410 flowmeter
- Sensor cable with M12 connector
- SD card with production certificates
- Quick Start guide
- CD containing software, certificates and device manuals

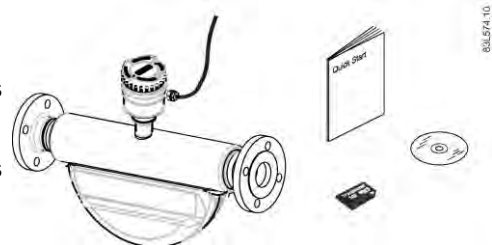

With sensor terminal housing

- SITRANS FC410 flowmeter
- Sensor cable
- Packet of cable glands
- SD card with production certificates
- Quick Start guide
- CD containing software, certificates and device manuals

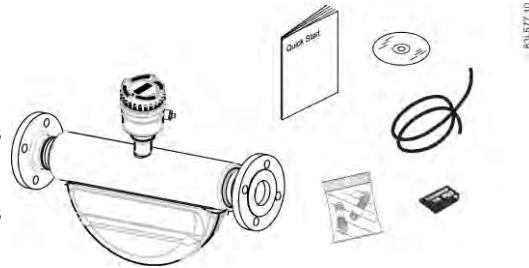

Note

Supplementary information

Supplementary product and production specific certificates are included on the SensorFlash® SD card.

Note

Scope of delivery may vary, depending on version and add-ons. Make sure the scope of delivery and the information on the nameplate correspond to your order and the delivery note.

1.3 Checking the consignment

1. Check the packaging and the device for visible damage caused by inappropriate handling during shipping.
2. Report any claims for damages immediately to the shipping company.
3. Retain damaged parts for clarification.
4. Check the scope of delivery by comparing your order to the shipping documents for correctness and completeness.

 WARNING
Using a damaged or incomplete device
Danger of explosion in hazardous areas.
<ul style="list-style-type: none">• Do not use damaged or incomplete devices.

1.4 Device identification

Each part of the FC410 Coriolis flowmeter has three nameplate types showing the following information:

- product identification
- product specifications
- certificates and approvals

Note Identification

Identify your device by comparing your ordering data with the information on the product and specification nameplates.

FC410 sensor identification nameplate

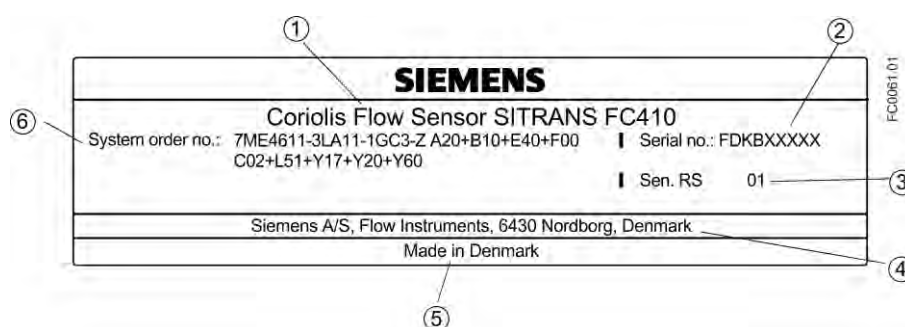

- | | | |
|---|------------------|-------------------------------------|
| ① | Product name | Sensor product name |
| ② | Serial no. | Flowmeter serial number |
| ③ | Sen. RS | Mechanical sensor version number |
| ④ | Manufacturer | Manufacturer name and location |
| ⑤ | Country | Manufacturing country |
| ⑥ | System order no. | Device-specific system order number |

Figure 1-1 FC410 identification nameplate example

Flowmeter serial number construction

The flowmeter serial number is constructed as follows:

PPPYMDDxxxxxx

where

PPP = Production factory (Siemens Flow Instruments: FDK)

Y = Production year (for encryption, see below)

M = Production month (for encryption, see below)

DD = Production date (for encryption, see below)

xxxxxx = Sequential number

Encryption:

Calendar year (Y)	Code
1950, 1970, 1990, 2010	A
1951, 1971, 1991, 2011	B
1952, 1972, 1992, 2012	C
1953, 1973, 1993, 2013	D
1954, 1974, 1994, 2014	E
1955, 1975, 1995, 2015	F
1956, 1976, 1996, 2016	H (G)
1957, 1977, 1997, 2017	J
1958, 1978, 1998, 2018	K
1959, 1979, 1999, 2019	L
1960, 1980, 2000, 2020	M
1961, 1981, 2001, 2021	N
1962, 1982, 2002, 2022	P
1963, 1983, 2003, 2023	R
1964, 1984, 2004, 2024	S
1965, 1985, 2005, 2025	T
1966, 1986, 2006, 2026	U
1967, 1987, 2007, 2027	V
1968, 1988, 2008, 2028	W
1969, 1989, 2009, 2029	X
Month (M)	Code
January	1
February	2
March	3
April	4
May	5
June	6
July	7
August	8
September	9
October	O
November	N
December	D
Date (DD)	Code
Day 1 to 31	01 to 31 (corresponding to the actual date)

FC410 sensor specification nameplate

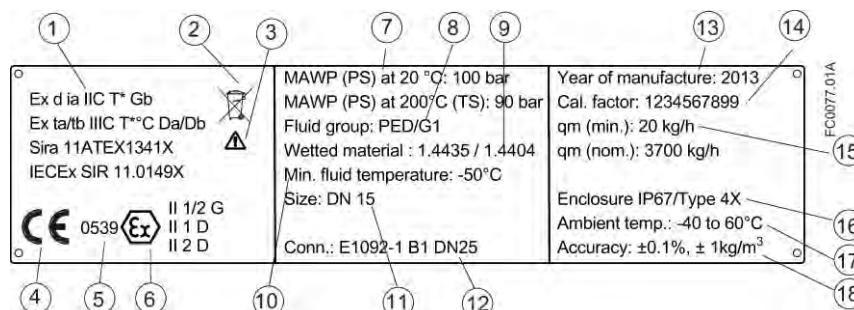

- | | | |
|---|------------------------|--|
| ① | EX approvals | Ex approval specifications for the sensor (ATEX example) |
| ② | | WEEE Device disposal |
| ③ | | Consult the operating instructions |
| ④ | CE | CE mark |
| ⑤ | 0539 | Notified Body ID (ATEX) |
| ⑥ | Ex | Ex mark |
| ⑦ | MAWP | Maximum allowable working pressures at 20 °C (68 °F) and 200 °C (392 °F) (max. temperature) |
| ⑧ | Fluid group | Fluid group statement required by PED |
| ⑨ | Wetted material | Tube/process connection materials |
| ⑩ | Min. fluid temperature | Minimum fluid temperature |
| ⑪ | Size DN | Nominal size |
| ⑫ | Conn. | Process connection type and size |
| ⑬ | Year of Manufacture | Manufacturing year
More detailed manufacturing date information is given in the serial number found on the identification nameplate |
| ⑭ | Cal. Factor | Calibration factor |
| ⑮ | Qm (min)
Qm (nom) | Minimum and nominal flows with water at 20 °C (68 °F) |
| ⑯ | Enclosure IP | Degree of protection |
| ⑰ | Ambient Temp. | Ambient temperature range |
| ⑱ | Accuracy | Accuracy for massflow and density |

Figure 1-2 FC410 specification nameplate example

FC410 Mini Flow Link (MFL) identification nameplate

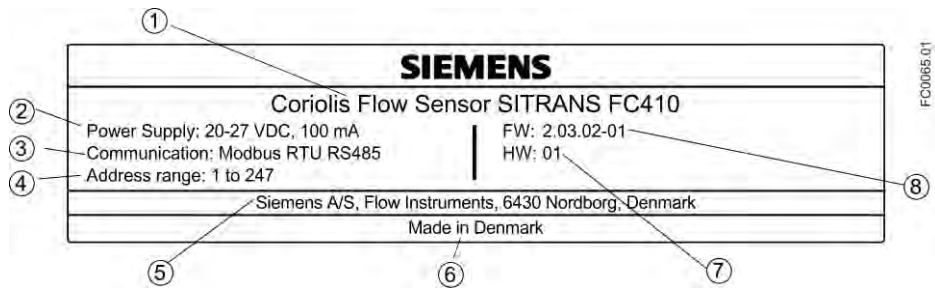

- | | | |
|---|---------------|---|
| ① | Product name | Name of device |
| ② | Power supply | Power supply |
| ③ | Communication | Communication: Modbus Master/Slave RTU technology |
| ④ | Address range | Modbus device address range |
| ⑤ | Manufacturer | Manufacturer name and location |
| ⑥ | Country | Manufacturing country |
| ⑦ | HW | Hardware version |
| ⑧ | FW | Firmware version |

Figure 1-3 FC410 Mini Flow Link identification nameplate

Note

Approval identifications

Approval certificates and notified body identifications are available for download at siemens.com

FC410 sensor approval nameplate

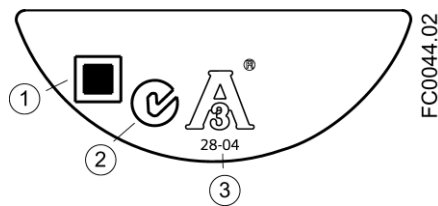

- | | | |
|---|---------|--------------------------|
| ① | QR code | Product-specific QR code |
| ② | C✓ | C-tick logo |
| ③ | 3A | 3A logo |

Figure 1-4 FC410 approval nameplate example

Note**Logos and warnings**

Logos and warnings are only shown on the product where applicable. The combination shown in the example above is relevant for a hygienic sensor.

The Australian C-tick mark is mandatory on all products.

FC410 EHEDG nameplate

Figure 1-5 EHEDG nameplate

This nameplate appears on all Hygienic sensors 7ME462.

Other label

Figure 1-6 How to install

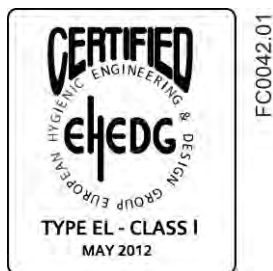
The QR code provides direct internet connection to

- The product support portal, which includes access to the "How to Install" YouTube video. (This example provides that function.)
- Product and production-specific documentation maintained in the production database.

See also

Device disposal (Page 86)

1.5 Further Information

Product information on the Internet

The Operating Instructions are available on the CD-ROM shipped with the device, and on the Internet on the Siemens homepage, where further information on the range of SITRANS F flowmeters may also be found:

Product information on the internet (<http://www.siemens.com/flow>)

Worldwide contact person

If you need more information or have particular problems not covered sufficiently by these Operating Instructions, get in touch with your contact person. You can find contact information for your local contact person on the Internet:

Local contact person (<http://www.automation.siemens.com/partner>)

Safety notes

This device left the factory in good working condition. In order to maintain this status and to ensure safe operation of the device, observe these instructions and all the specifications relevant to safety.

Observe the information and symbols on the device. Do not remove any information or symbols from the device. Always keep the information and symbols in a completely legible state.

Symbol	Explanation
	Consult operating instructions

2.1 Laws and directives

Observe the test certification, provisions and laws applicable in your country during connection, assembly and operation. These include, for example:

- National Electrical Code (NEC - NFPA 70) (USA)
- Canadian Electrical Code (CEC) (Canada)

Further provisions for hazardous area applications are for example:

- IEC 60079-14 (international)
- EN 60079-14 (EC)

Conformity with European directives

The CE marking on the device symbolizes the conformity with the following European directives:

Electromagnetic compatibility EMC
2004/108/EC

Directive of the European Parliament and of the Council on the approximation of the laws of the Member States relating to electromagnetic compatibility and repealing Directive 89/336/EEC.

Low voltage directive LVD
2006/95/EC

Directive of the European Parliament and of the Council on the harmonisation of the laws of Member States relating to electrical equipment designed for use within certain voltage limits.

2.2 CE declaration

Atmosphère explosible
ATEX
94/9/EC

Directive of the European Parliament and the Council on the approximation of the laws of the Member States concerning equipment and protective systems intended for use in potentially explosive atmospheres.

Pressure equipment
directive PED
97/23/EC

Directive of the European Parliament and of the Council on the approximation of the laws of the Member States concerning pressure equipment.

The applicable directives can be found in the EC conformity declaration of the specific device. Further country or region-specific code conformity information is available on request.

 **WARNING**

Improper device modifications

Danger to personnel, system and environment can result from modifications to the device, particularly in hazardous areas.

- Only carry out modifications that are described in the instructions for the device. Failure to observe this requirement cancels the manufacturer's warranty and the product approvals.

2.2 CE declaration

Note

CE declaration

The CE declaration certificate is required to be included with each flowmeter. The certificate is therefore available on the SensorFlash SD card delivered with the device.

2.3 Installation in hazardous locations

 **WARNING**

Equipment used in hazardous locations

Equipment used in hazardous locations must be Ex-approved for the region of installation and marked accordingly. It is required that the special conditions for safe use provided in the manual and in the Ex certificate are followed!

Hazardous area approvals

The device is approved for use in hazardous area and has the approvals listed below. Special conditions for safe installation and operation specified by each approval authority are included in the relevant certificate.

ATEX:

FC410 flowmeter (can be installed in Zone 1 for gas and Zone 20 for dust):

ATEX Certificate: SIRA 11ATEX1341X

 II 1/2 GD

Ex d ia IIC T* Gb

Ex ta/tb IIIC T*°C Da/Db

Ta = -40°C to +60°C

* Temperature class (dependent on the "Maximum Process Temperature", see "Special Conditions for Safe Use")

IECEX:

FC410 flowmeter (can be installed in Zone 1 for gas and Zone 20 for dust):

Certificate: IECEX SIR 11.0149X

Ex d ia IIC T* Gb

Ex ta/tb IIIC T*°C Da/Db

(Ta = -40°C to +60°C)

* Temperature class (dependent on the "Maximum Process Temperature", see "Conditions of Certification")

FM:

Sensor with Mini Flow Link (MFL) (FC410):

Class I Division 1 Groups A,B,C,D T* (XP, IS)

Class II Division 1 Groups E,F,G

Class III Division 1 Group H (granulates)

Class I Zone 1 and Zone 20/21

*: Depends on media temperature and ambient temperature (T6-T2)

Maximum temperature specifications for Ex use

Device temperature classification with and without dust is related to the process temperature and ambient temperature as listed below.

The maximum allowable process fluid temperatures with respect to temperature class for the device when used with potentially explosive gases in a maximum ambient temperature of +60°C are:

2.3 Installation in hazardous locations

Ta (°C)	Maximum Process Temperature per Temperature Class (°C)			
	T6	T5	T4	T3
60	70	70	70	70
55	85	100	100	100
50	85	100	130	130
45	85	100	135	160
40	85	100	135	190
35	85	100	135	200
30	85	100	135	200

If the equipment is placed in a "tb" environment (Zone 21), the maximum process temperatures shall be as follows:

Ta (°C)	Maximum Process Temperature per Temperature Class (°C)
60	70
55	100
50	130
45	160
40	190
35	200
30	200

Additionally, the maximum surface temperature of the overall device shall be:

- If $T_{process} \leq 85^{\circ}C$, maximum surface temperature = $85^{\circ}C$.
- If $T_{process} > 85^{\circ}C$, maximum surface temperature = process temperature.

If the equipment is placed in a "ta" environment (Zone 20), the maximum process temperature shall be as follows:

Ta (°C)	Maximum Process Temperature per Temperature Class (°C)
60	-40
55	-10
50	20
45	50
40	80
35	110
30	140

Special conditions for safe use

In general, it is required that:

- The equipment shall not be opened when energized and when an explosive gas or dust atmosphere may be present..
- Appropriate cable connectors are used.
- Sensor is connected to the potential equalization throughout the hazardous area.
- EN/IEC 60079-14 is considered for installation in hazardous areas.

Further information and instructions including approval-specific special conditions for safe use in Ex applications can be found in the certificates on the accompanying literature CD and at www.siemens.com/FC410 (www.siemens.com/FC410).

 WARNING
Laying of cables Explosion hazard
Cable for use in hazardous locations must satisfy the requirements for having a proof voltage of at least 500 V AC applied between the conductor/ground, conductor/shield and shield/ground.
Connect the devices that are operated in hazardous areas as per the stipulations applicable in the country of operation.

 WARNING
Field wiring installation
Ensure that the national requirements of the country in which the devices are installed are met.

2.4 Certificates

Certificates are posted on the Internet and on the documentation CD-ROM shipped with the device.

See also

Certificates on the Internet (<http://www.siemens.com/processinstrumentation/certificates>)

Certification documents including calibration report are supplied with each sensor included on the SensorFlash. Material, pressure test, and factory conformance certificates are optional at ordering.

Description

Measurement of liquids and gases

SITRANS F C Coriolis mass flowmeters are designed for measurement of a variety of liquids and gases. The flowmeters are multi-parameter devices offering accurate measurement of massflow, volumeflow, density, temperature and, depending on product variants, fraction, including industry-specific fractions.

Main applications

The main applications of the Coriolis flowmeter can be found in all industries, such as:

- Chemical & Pharma: detergents, bulk chemicals, acids, alkalis, pharmaceuticals, blood products, vaccines, insulin production
- Food & Beverage: dairy products, beer, wine, soft drinks, °Brix/°Plato, fruit juices and pulps, bottling, CO₂ dosing, CIP/SIP-liquids, mixture recipe control
- Automotive: fuel injection nozzle & pump testing, filling of AC units, engine consumption, paint robots
- Oil & Gas: filling of gas bottles, furnace control, test separators, bore-hole plasticizer dosing, water-cut metering
- Water & Waste Water: dosing of chemicals for water treatment

Note

Use in a domestic environment

This is a Class A Group 1 equipment intended for use in industrial areas.

In a domestic environment this device may cause radio interference.

3.1 Design

The SITRANS FC410 flowmeter uses the Coriolis principle to measure flow. The device is a one channel flowmeter with Modbus RTU RS 485 output.

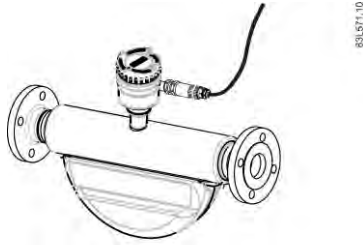

Figure 3-1 Flowmeter - M12 connection

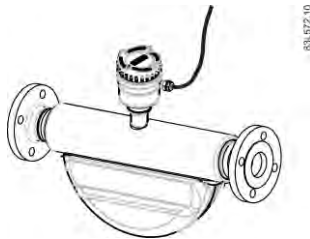

Figure 3-2 Flowmeter – terminated cable

Flowmeter design

All primary process measurement of massflow, volumeflow, density and process temperature are made in the MFL/sensor front end.

The sensor comprises two parallel bent tubes welded directly to the process connections at each end via a manifold.

The sensors are available in AISI 316L stainless steel and Hastelloy C22. The enclosure is made of AISI 304 stainless steel which has a pressure rating of 20 bar (290 psi) for DN 15 to DN 50 and 17 bar (247 psi) for DN 80. The burst pressure for all sizes is in excess of 160 bar.

The sensor enclosure can be equipped with a pressure guard or flushed with dry inert gas at the threaded ports for non-hazardous applications only.

Note

Ex certification requires that the threaded ports always remain closed.

The Mini Flow Link is available in an aluminum enclosure with an ingress protection grade of IP67/NEMA 4X. It has a 4-wire M12 cable or terminated cable connection for communication and power supply.

Flowmeter overview

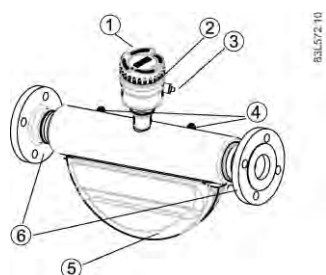

- ① Mini Flow Link (MFL)
- ② Lid-lock
- ③ Cable feed-through (M12 socket or gland)
- ④ Plug and threaded port for example for pressure guard
- ⑤ Sensor enclosure
- ⑥ Process connections

Figure 3-3 Overview of FC410 flowmeter

3.2 System integration

The FC410 flowmeter functions as a Modbus RTU slave with standard Modbus commands implemented. Setup parameters, process values, diagnostics, and status information are mapped as Modbus registers.

The device can be connected point-to-point or in a multidrop network in non-hazardous or hazardous locations. It can be connected to different hosts for example a PLC system or a PC used as service tool or configuration tool.

Note

Multidrop installations in hazardous locations

Multidrop installations in hazardous locations require flameproof conduit seals for each device, see illustrations in System configurations (Page 45)

3.3 Modbus RTU technology

Modbus RTU is an open, serial protocol based on master/slave architecture. The protocol interconnects field equipment such as sensors, actuators, and controllers and is widely used in both process and manufacturing automation. The fieldbus environment is the base level group of digital networks in the hierarchy of plant networks.

Features

The SITRANS F Modbus RTU communication complies with the Modbus Serial Line Protocol. Among other things this implies a master / slave protocol at level 2 of the OSI model. A node (the master) issues explicit commands to one of the slave nodes and processes responses. Slave nodes will not transmit data without a request from the master node, and do not communicate with other slaves.

Modbus is a mono master system, which means that only one master at a time can be connected.

Unicast communication mode

In unicast mode (master/slave mode) the master sends a request to a specific slave device and waits a specified time for a response.

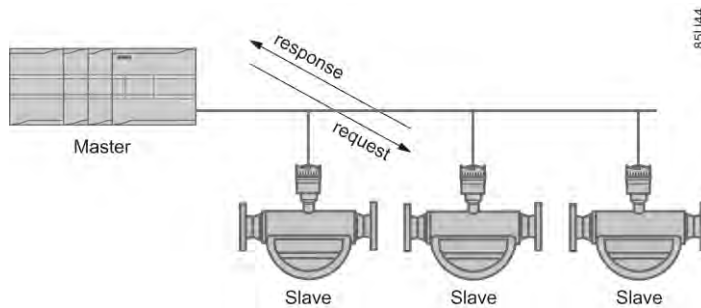

Figure 3-4 Unicast Mode

Modbus Frame

The Modbus frame is shown below and is valid for both requests and responses.

Table 3- 1 Modbus Frame

SLAVE ADDRESS	FUNCTION MODE	DATA	CRC
1 Byte	1 Byte	0 to 252 Bytes	2 Bytes

References

For further information, please refer to the following specification and guidelines available at the Modbus Organization (<http://www.modbus.org/>) website

1. Serial Line Specification & Implementation guide
2. Application Protocol Specification

3.4 Features

- The SITRANS FC410 can be used as Modbus slave in stand-alone or parallel operation on Modbus or third party automation systems
- Compact sensor design
- NAMUR conforming sensor built-in lengths (on request)
- High immunity against process noise
- Fast response to step changes in flow
- High update rate (100 Hz) on all process values
- Measurement of:
 - Massflow
 - Volumeflow
 - Density
 - Process media temperature
- Independent low flow cut-off settings for massflow and volumeflow
- Automatic zero-point adjustment (initiated by host system)
- Process noise damping using digital signal processing (DSP).
- One totalizer for summation of massflow. The totalizer is reset on loss of power.
- Empty pipe monitoring
- Simulation of process values:
 - Massflow
 - Volumeflow
 - Density
 - Process media temperature
- Troubleshooting and sensor checking
- Use in hazardous locations according to specification

3.5 Theory of operation

The Coriolis principle of measurement

The flow measurement is based on the Coriolis law of motion. Particles moving in a rotating / oscillating system will resist imposed oscillations in a manner consistent with their mass and velocity (momentum). Oscillation produced by a Coriolis flowmeter where the process media is accelerated around bends results in phase distortions of the measuring tubes.

The SITRANS F C sensors are energized by an electromagnetic (voice coil) driver circuit which oscillates the pipes at their resonant frequency. Two pickups are placed symmetrically on either side of the driver to provide position signals for digital processing.

When the media flows through the sensor, Coriolis force will act on the measuring tubes and cause deflection which can be measured as a phase shift between Pickup 1 and Pickup 2. The phase shift is proportional to the mass flowrate.

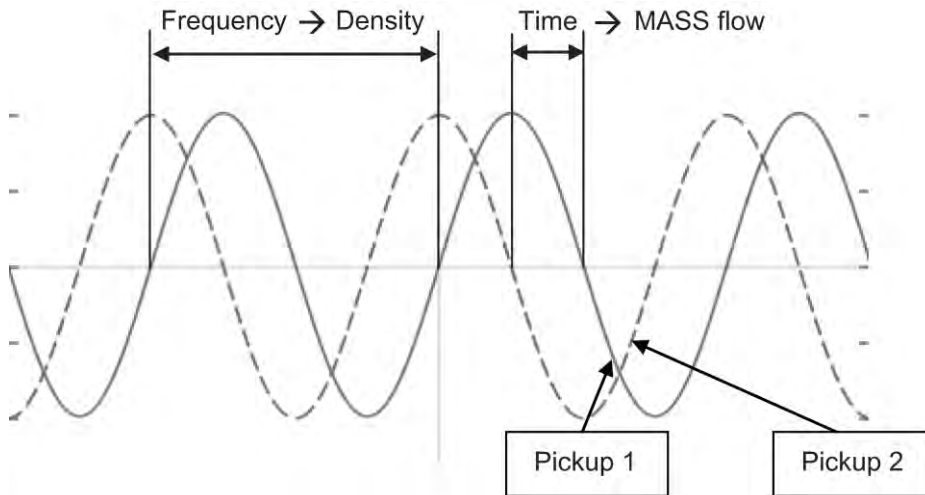

The frequency (or period) of the vibration is a direct function of the process media density.

The frequency and amplitude of the driver is regulated to ensure a stable output from the 2 pickups. The temperature of the sensor tubes is measured to provide accurate compensation for changes in the material stiffness. As a result the process media temperature is also accurately measured.

The flow proportional phase signal from the pickups, the temperature measurement and the driver frequency enable calculation and reporting of mass, density, volume, and temperature.

Digital signal processing (DSP)

The analog to digital conversion takes place in an ultra low noise sigma delta converter with high signal resolution. With fast digital signal processing massflow and density values are calculated using a patented DFT technology (Discrete Fourier Transformation). The combination of this patented DFT technology and the fast DSP enables short response time (< 10 ms) to changes in the measured values.

The built-in noise filter is configurable and can be used for improving the performance of the flowmeter, in case the installation and application conditions are not ideal. Typical process noise such as gas bubbles (two-phase-flow) can be reduced through the filter functions.

Installing/Mounting

4.1 Introduction



SITRANS F flowmeters with minimum IP67/NEMA 4X enclosure rating are suitable for indoor and outdoor installations.

- Make sure that specifications for rated process pressure (PS) and media temperature (TS) plus ambient temperature that are indicated on the device nameplate / label will not be exceeded.

 WARNING
Installation in hazardous location
Special requirements apply to the location and installation of the device. See Installation in hazardous locations (Page 16).

4.2 Flowmeter installation

4.2.1 Installation safety precautions

 WARNING
High pressure hazard
In applications with working pressures/media that can be dangerous to people, surroundings, equipment or others in case of pipe fracture, we recommend that special precautions such as special placement, shielding or installation of a pressure guard or a safety valve are taken when the flowmeter is mounted.

 WARNING
Exceeded maximum permissible operating pressure Danger of injury or poisoning. The maximum permissible operating pressure depends on the device version. The device can be damaged if the operating pressure is exceeded. Hot, toxic and corrosive process media could be released. <ul style="list-style-type: none">• Make sure that the device is suitable for the maximum permissible operating pressure of your system. Refer to the information on the nameplate and/or in "Rated operating conditions (Page 98)".

 CAUTION
Hot surfaces resulting from hot process media Danger of burns resulting from surface temperatures above 70 °C (155 °F). <ul style="list-style-type: none">• Take appropriate protective measures, for example contact protection.• Make sure that protective measures do not cause the maximum permissible ambient temperature to be exceeded. Refer to the information in Chapter "Rated operating conditions (Page 98)".

 CAUTION
External stresses and loads Damage to device by severe external stresses and loads (e.g. thermal expansion or pipe tension). Process media can be released. <ul style="list-style-type: none">• Prevent severe external stresses and loads from acting on the device.

 WARNING
Wetted parts unsuitable for the process media Danger of injury or damage to device. Hot, toxic and corrosive media could be released if the process medium is unsuitable for the wetted parts. <ul style="list-style-type: none">• Ensure that the material of the device parts wetted by the process medium is suitable for the medium. Refer to the information in "Technical data" (Page 103).

Note

Material compatibility

Siemens can provide you with support concerning selection of sensor components wetted by process media. However, you are responsible for the selection of components. Siemens accepts no liability for faults or failures resulting from incompatible materials.

4.2.2 Determining a location

 CAUTION
Electromagnetic fields
Do not install the flowmeter in the vicinity of strong electromagnetic fields, for example near motors, variable frequency drives, transformers etc.

Upstream / downstream

- No pipe run requirements, that is straight inlet/outlet sections are not necessary.
- Avoid long drop lines downstream from the sensor to prevent process media separation causing air / vapour bubbles in the tube (min. back pressure: 0.2 Bar).
- Avoid installing the flowmeter immediately upstream of a free discharge in a drop line.

Location in the system

The optimum location in the system depends on the application:

- Liquid applications
Gas or vapor bubbles in the fluid may result in erroneous measurements, particularly in the density measurement.
 - Do not install the flowmeter at the highest point in the system, where bubbles will be trapped.
 - Install the flowmeter in low pipeline sections, at the bottom of a U-section in the pipeline.

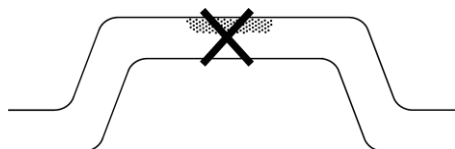

Figure 4-1 Liquid applications, wrong location with trapped air/gas

- Gas applications
Vapor condensation or oil traces in the gas may result in erroneous measurements.
 - Do not install the flowmeter at the lowest point of the system.
 - Install a filter.

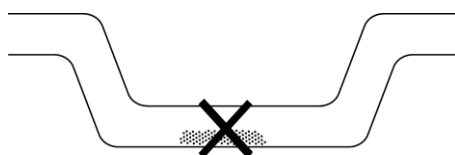

Figure 4-2 Gas applications, wrong location with trapped oil

4.2.3 Orientation of the device

Flow direction

The calibrated flow direction is indicated by the arrow on the sensor. Flow in this direction will be indicated as positive by default. The sensitivity and the accuracy of the sensor do not change with reverse flow.

The indicated flow direction (positive/negative) is configurable.

 CAUTION
Accurate measurement
The sensor must always be completely filled with process media in order to measure accurately.

Orienting the sensor

The sensor operates in any orientation. The optimal orientation depends on the process fluid and the process conditions. Siemens recommends orienting the sensor in one of the following ways:

1. Vertical installation with an upwards flow (self-draining)

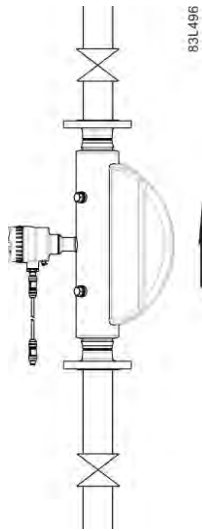

Figure 4-3 Vertical orientation, upwards flow

2. Horizontal installation, tubes down (recommended for liquid applications)

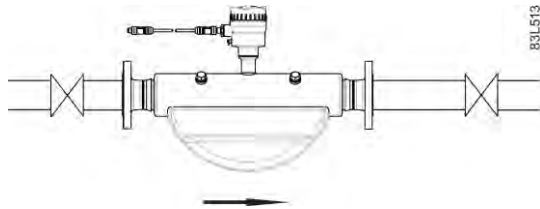

Figure 4-4 Horizontal orientation, tubes down

3. Horizontal installation, tubes up (recommended for gas applications)

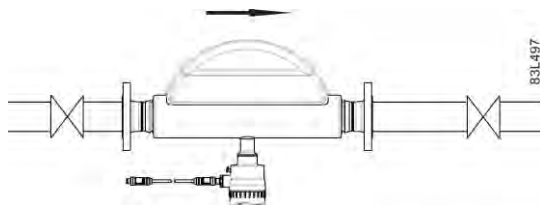

Figure 4-5 Horizontal orientation; tubes up

Note

Hygienic applications

In 3A and EHEDG certified hygienic applications the flowmeter must be installed vertically as shown in 1 above.

Installation in a drop line

Installation in a drop line is only recommended if a pipeline reduction or orifice with a smaller cross-section can be installed to create back-pressure and prevent the sensor from being partially drained while measuring.

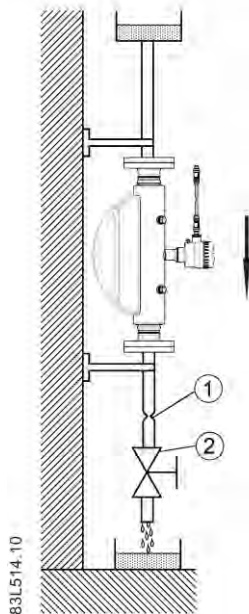

- ① Back pressure orifice
- ② On / off valve

Figure 4-6 Installation in drop line

4.2.4 Mounting the flowmeter

NOTICE

Incorrect mounting

The device can be damaged, destroyed, or its functionality impaired through improper mounting.

- Before installing ensure there is no visible damage to the device.
- Make sure that process connectors are clean, and suitable gaskets and glands are used.
- Mount the device using suitable tools. Refer to the information in Chapter "Technical data (Page 95)", for example installation torques requirements.



WARNING

Unsuitable connecting parts

Danger of injury or poisoning.

In case of improper mounting hot, toxic and corrosive process media could be released at the connections.

- Ensure that connecting parts (such as flange gaskets and bolts) are suitable for connection and process media.

- Install the flowmeter in well-supported pipelines in order to support the weight of the device.
- Center the connecting pipelines axially in order to assure a stress-free installation. The flowmeter must not be used to bring the rest of the pipework into line; make sure the pipework is correctly aligned before inserting the flowmeter.
- Install two supports or hangers symmetrically and stress-free on the pipeline in close proximity to the process connections.

Note

Handling

Never lift the flowmeter using the housing, that is, always lift the sensor body.

Avoid vibrations

- Make sure that no valves or pumps upstream of the flowmeter cavitates or sends vibration into the sensor.
- Decouple vibrating pipeline from the flowmeter using flexible tube or couplings

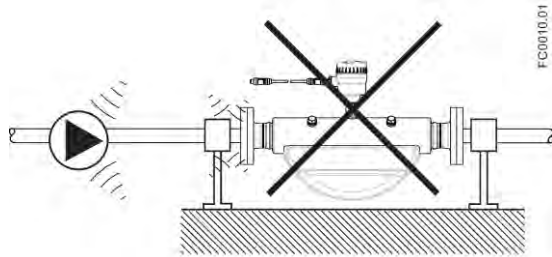

Figure 4-7 Non-flexible pipes not recommended in vibrating environment

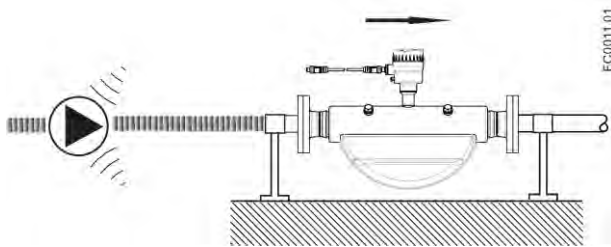

Figure 4-8 Flexible pipes recommended in vibrating environment

Avoid cross talk

If operating more than one flowmeter in one or multiple interconnected pipelines there is a risk of cross talk.

Prevent cross talk in one of the following ways:

- Mount sensors on separate frames
- Decouple the pipeline using flexible tube or couplings

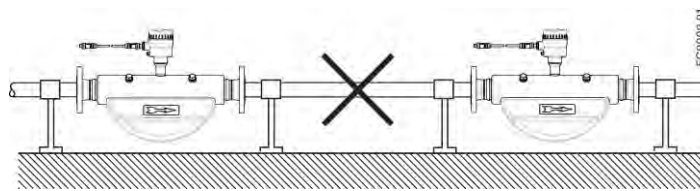

Figure 4-9 High risk of cross talk when using non-flexible pipes

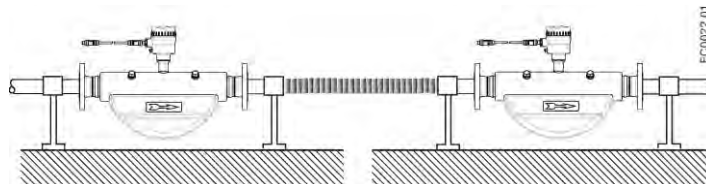



Figure 4-10 Low risk of cross talk when using flexible pipes

4.2.5 Hydrostatic testing

The flowmeter is pressure-tested before delivery to 1.5 times the rated working pressure of the sensor.

- In the case of process connections pressure-rated less than 100 bar, the connection is the limiting component.
- In the cases of stainless steel sensors with process connections pressure-rated above 100 bar, the sensor is the limiting component.

In all cases the maximum allowed hydrostatic test pressure (MATP) of the flowmeter is 1.5 times the marked MAWP (PS) at 20 °C.

 WARNING
Risk of equipment damage Never pressure test a completed flow system with piping and other components at pressures higher than 1.5 times the marked MAWP (PS) at 20 °C of the lowest rated component in the system.

4.2.6 Mounting a pressure guard

The sensor enclosure is supplied with two G $\frac{1}{2}$ " (parallel thread) purge ports. These ports can for example be used for a pressure guard, which can be connected to an automatic shut off valve to stop the flow in case of sensor pipe fracture.

Note

Non-hazardous locations only

A pressure guard can be applied only in non-hazardous locations.

Note

Avoid opening purge ports

Opening either of the purge ports will void any Ex rating for the sensor.

The AISI 304 / EN 1.4301 exterior enclosure is rated to approximately 20 bar static pressure to contain spilt process media in the event of a tube break. However it is not intended to contain high pressure or corrosive fluids and precautions must be taken in applications where vibrating tube failure is probable and may cause damage.

Pressure guard selection

Siemens does not supply the components of the pressure guard solution because the arrangement and components are closely related to individual safety and protection practices in each place.

The selection of pressure guard solution is the responsibility of the user, however Siemens recommends the following forms of pressure guard:

4.2 Flowmeter installation

- A pressure switch screwed directly or piped into one of the purge ports and connected to an automatic shut-off valve will disable pressurized supply to the meter.
- A relief valve or bursting disc screwed directly or piped to one of the purge ports to carry any spilt fluid to drain after opening.

The pressure switch and relief valve set point should be 2-3 bar gauge. The pressure switch should be rated to withstand the full process pressure and temperature for a short time without rupture.

 CAUTION
Drain flow Ensure the drain flow is safely contained away from personnel and other plant or equipment.

Mounting of pressure guard

 CAUTION
Moisture, liquids or particles getting into the sensor enclosure All sensors are filled with argon to avoid condensation. Ingress of moisture, liquids or particles into the sensor may influence the measurement and in worst case inhibit the measuring function. <ul style="list-style-type: none">• Avoid moisture, liquids or particles getting into the sensor enclosure

Install a pressure guard as follows:

1. Place the sensor in a dry, clean place and leave it to acclimatize until it reaches ambient temperature, preferred 20°C (68°F) with low humidity (at least below 50% RH).
2. Orient the sensor with the purge ports uppermost to minimize loss of the argon gas filling.
3. Carefully remove the plug and mount the pressure guard.
Use replacement soft metal sealing rings for proper sealing.

 CAUTION
Lack of proper sealing Soft metal sealing rings only maintain a hermetic seal within the enclosure with single use. <ul style="list-style-type: none">• Ensure that soft metal sealing rings are not reused.

4. Make sure that the pressure guard does NOT touch any of the parts inside the sensor. Maximum of 20 mm (0.79") insertion can be accommodated.
5. Check that the pressure guard has been correctly mounted and thoroughly tightened (torque: 80 Nm).

 WARNING
Operation in proximity with pressure guards
Prevent personal injuries by assuring that operation in close proximity with pressure guards cannot take place.

Connecting

This chapter describes how the device is connected and integrated into a Modbus network in a point-to-point or multidrop configuration.

5.1 Wiring in hazardous locations

Hazardous area applications

Special requirements apply to the location and interconnection of flowmeter and flameproof conduit seals. Two conduit seals per device must be installed; one at the device in the hazardous location and one in the non-hazardous location.

 WARNING
--

MFL housing

Before opening the MFL housing check that:
--

- | |
|--|
| <ul style="list-style-type: none">• No explosion hazard exists• All connection leads are potential free |
|--|

Note**Output cables**

If long cables are used in noisy environments, it is recommended to use screened cables.

5.2 Cable requirements

Cable specifications

- Only use cables with at least the same degree of protection as the sensor to install the sensor. It is recommended to use cables supplied by Siemens A/S, Flow Instruments.
- Siemens supplied cables can be ordered with M12 plug on both ends or without plug.
- To guarantee the IP67 degree of protection, ensure that both ends of the cables are given equivalent protection from ingress of moisture.
- For further information on Siemens-supplied cables, see Technical Data (Page 104).

See also specifications of cable lengths in Wiring FC410 to the Modbus system (Page 49).

 WARNING
Cable requirements Cables must be suitable for the temperature (at least 70 °C) and be flammability-rated to at least V-2.

 WARNING
Unprotected cable ends Danger of explosion through unprotected cable ends in hazardous areas. <ul style="list-style-type: none">• Protect unused cable ends in accordance with IEC/EN 60079-14.

5.3 Safety notes for connecting

 WARNING
Skills Only qualified personnel may carry out work on the electrical connections.

Use in hazardous locations

Before accessing the sensor terminal space and application terminal space check that:

- No explosion hazard exists
- A safe access permission certificate has been issued by plant operations management
- All connection leads are potential free

 WARNING
Commissioning Only commission the device after the device has been properly connected and closed.

5.4 Connecting the FC410

Note

End Of Line (EOL) termination

The FC410 EOL termination DIP switch is default set to EOL active. To change termination setting see Setting the EOL termination DIP switches (Page 44).

5.4.1 M12 version

The sensor is provided with a preformed cable terminated with M12 style stainless steel weather-proof plugs.

The cable screen is physically and electrically terminated within the body of the plug.

Take care when handling the cable and passing it through cable ducting that the plug is not subjected to excessive tension (pulling) as the internal connections may be disengaged.

Note

Never pull the cable by the plug - only by the cable itself.

1. Connect the sensor using the supplied 4-wire cable with M12 connectors.

Note

Grounding

The sensor cable screen is mechanically connected to the grounding terminal (PE), only when the M12 plug is correctly tightened.

Terminal number	Description	Wire color (Siemens cable)
1	24 VDC	Orange
2	0 VDC	Yellow
3	B	White
4	A	Blue

5.4.2 Cable termination version

A: Prepare the cable by stripping it at both ends.

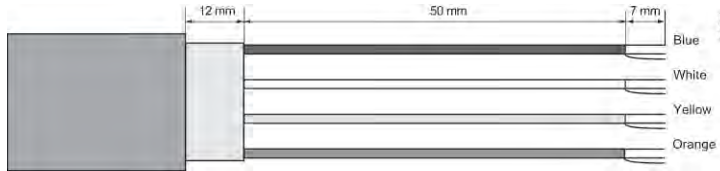

Figure 5-1 Cable end

B: Connect wires within the sensor terminal space

1. Remove the lock screw and remove the lid.
2. Undo the flexible strap.
3. Disconnect the sensor connection (white plug) from the electronic.
4. Loosen the mounting screw using a TX10 Torx driver and remove the electronic from the housing.
5. Remove the cap and the ferrule from the cable gland and slide onto the cable.
6. Push the cable through the open gland, anchor the cable shield and the wires with the clamp bar.
7. Remove the terminal block from the electronic.
8. Connect the wires to the terminals according to the list below and the label on the DSL lid.

Terminal number	Description	Wire color (Siemens cable)
1	24 VDC	Orange
2	0 VDC	Yellow
3	B	White
4	A	Blue

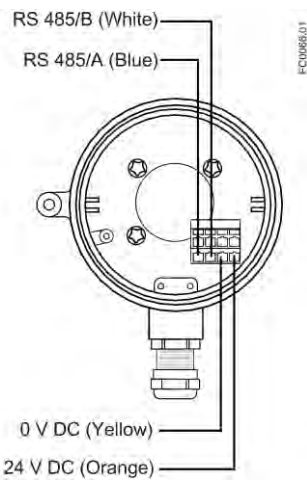

Figure 5-2 Sensor terminal space



Figure 5-3 Terminal 2

1. Reinstall the electronic including the mounting screw.
2. Connect the sensor connection and the sensor cable.
3. Restore the flexible strap around all wires.

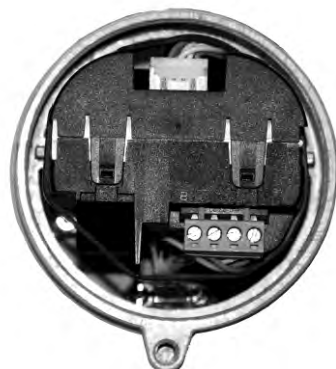

Figure 5-4 Terminal 1

4. Assemble and tighten the cable gland.

5. Remove the O-ring from lid.
6. Reinstall the lid and screw in until the mechanical stop. Wind back the lid by one turn.
7. Mount the O-ring by pulling it over the lid and tighten the lid until you feel friction from the O-ring on both sides. Wind the lid by one quarter of a turn to seal on the O-ring.
8. Reinstall and tighten the lid lock screw.

5.4.3 Setting the EOL termination DIP switches

It is important to terminate the Modbus RS 485 line correctly at the start and end of the bus segment since impedance mismatch results in reflections on the line which can cause faulty communication transmission.

If the device is at the end of the bus segment, it is recommended to terminate the device as shown in System configurations (Page 45). The table below shows the relation between the DIP switch settings and the permissible communication interface set-ups. Default configuration is EOL active.

Location of DIP switch

The DIP switch is located in the electronic as shown below.

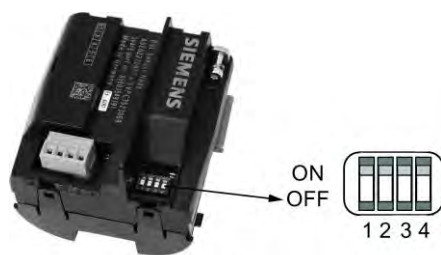

Figure 5-5 DIP switch location (all set to ON)

DIP switch settings for communication set-up

DIP switch Communication set-up	Switch 1	Switch 2	Switch 3	Switch 4
EOL not active	On	On	Off	Off
EOL active	On	On	On	On

NOTICE

Avoid DIP switch settings not mentioned in the table!

DIP switch settings not mentioned in the table above are not allowed and will cause a risk of reduction in communication interface reliability.

See also

System integration (Page 23)

5.5 Integrating the FC410 with Modbus system

This chapter provides information on how to integrate the flowmeter in a point-to-point or multidrop Modbus RTU network in non-hazardous or hazardous locations. Many details of network design are beyond the scope of these operating instructions. The points below provide an overview of the major design criteria. For further details contact Siemens.

If the device is integrated in a hazardous location, two flameproof conduit seals per device must be installed; one at the device in the hazardous location and one in the non-hazardous location, see System configurations (Page 45).

5.5.1 System configurations

Non-hazardous locations

The following figures show examples of installations in point-to-point and multidrop configurations in non-hazardous locations.

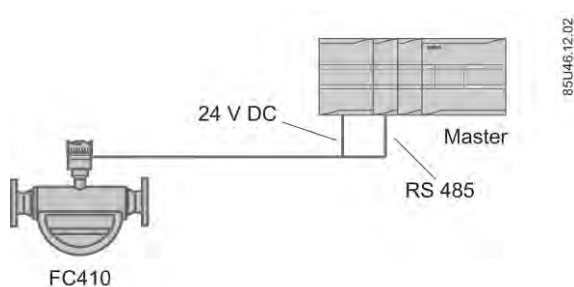

Figure 5-6 Point-to-point configuration in non-hazardous location

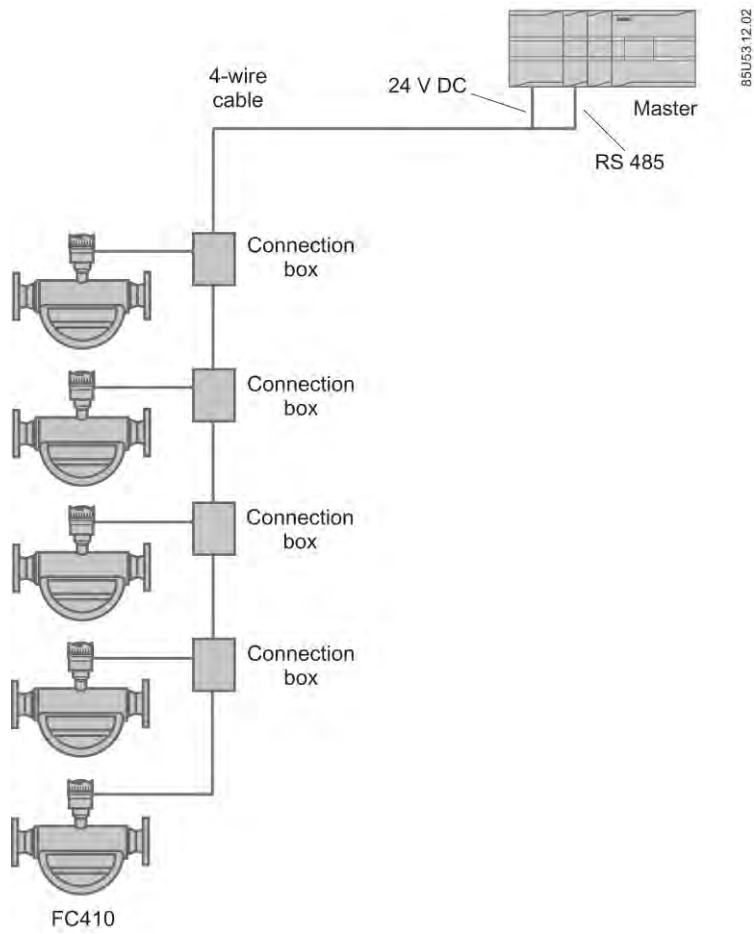

Figure 5-7 Multidrop configuration (branch) in non-hazardous location

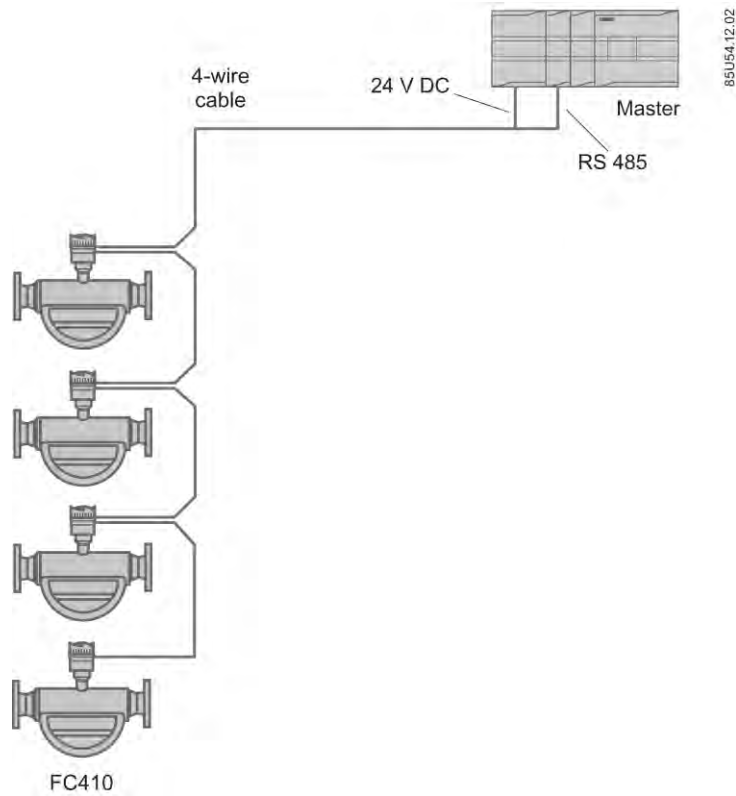

Figure 5-8 Multidrop configuration (Daisy chain) in non-hazardous location

Hazardous locations

The following figures show examples of installations in point-to-point and multidrop configurations in hazardous locations.

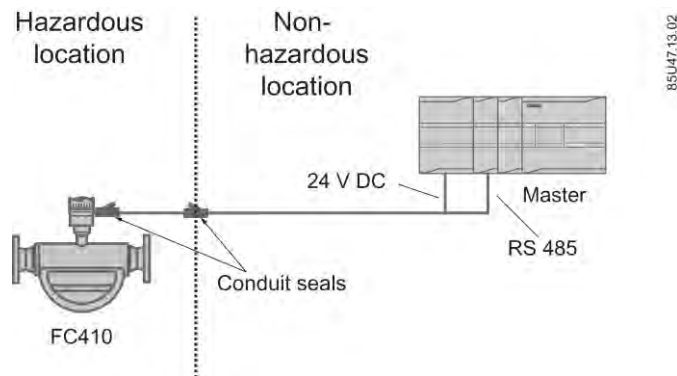

Figure 5-9 Point-to-point configuration in hazardous location

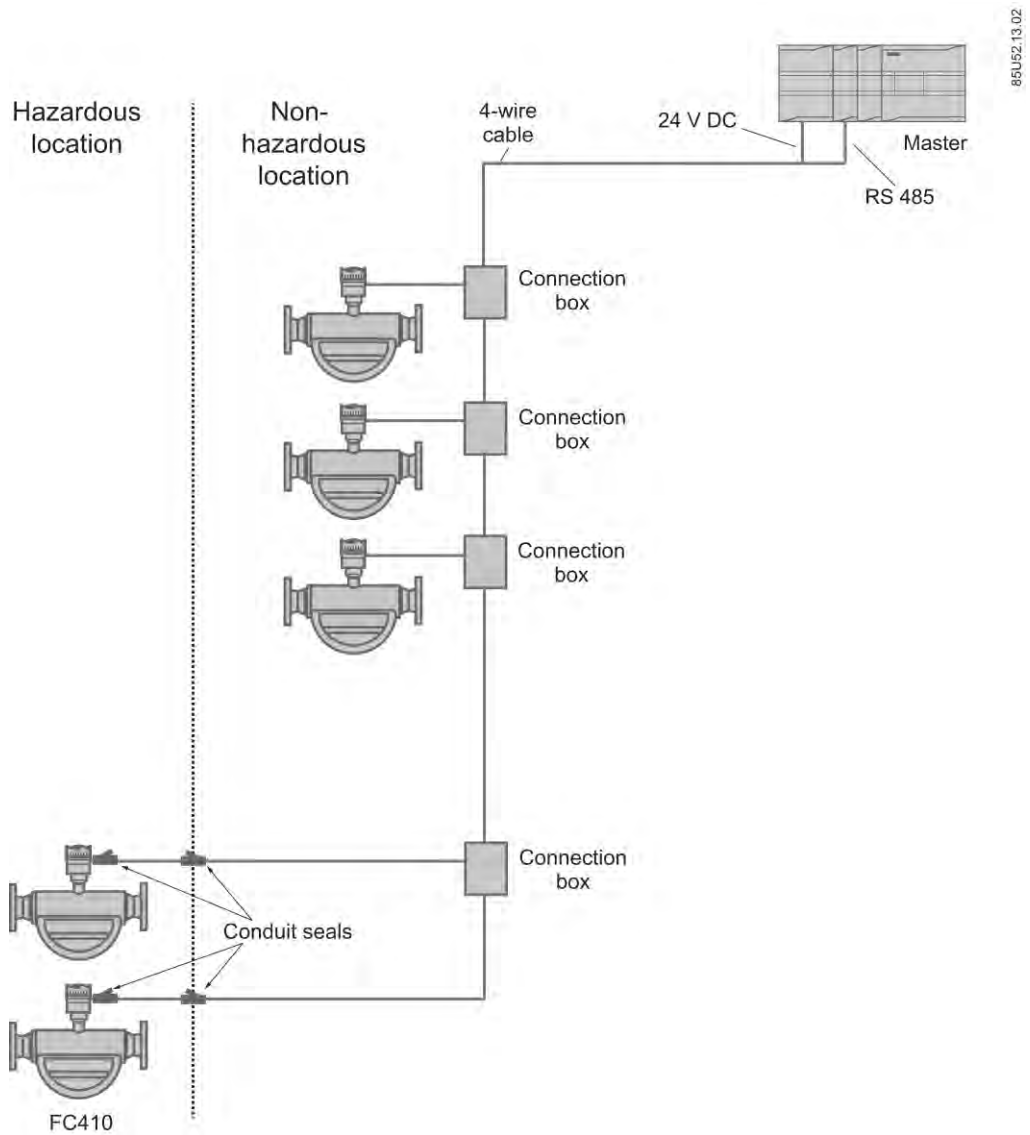

Figure 5-10 Multidrop configuration in hazardous location

NOTICE

Flameproof conduit seals

Two flameproof conduit seals are required for each device in hazardous area installations.

NOTICE

Equipment approved for hazardous locations

Ensure that the equipment is approved for installation in hazardous locations.

5.5.2 Wiring FC410 to the Modbus system

FC410 is slave in a 2-wire Modbus RTU RS 485 bus system where transmitter A must be connected to receiver A and transmitter B must be connected to receiver B. This corresponds to a half duplex communication where the slave will only reply to a request from the master.

Note

When joining the cables by short branch cables in a multidrop configuration, it is recommended to use EMC shielded enclosure to ensure proper signal installation.

- This example shows an EMC shielded enclosure for multidrop installation where the connection includes signal and power. Signal cable screen should be connected according to national requirements.

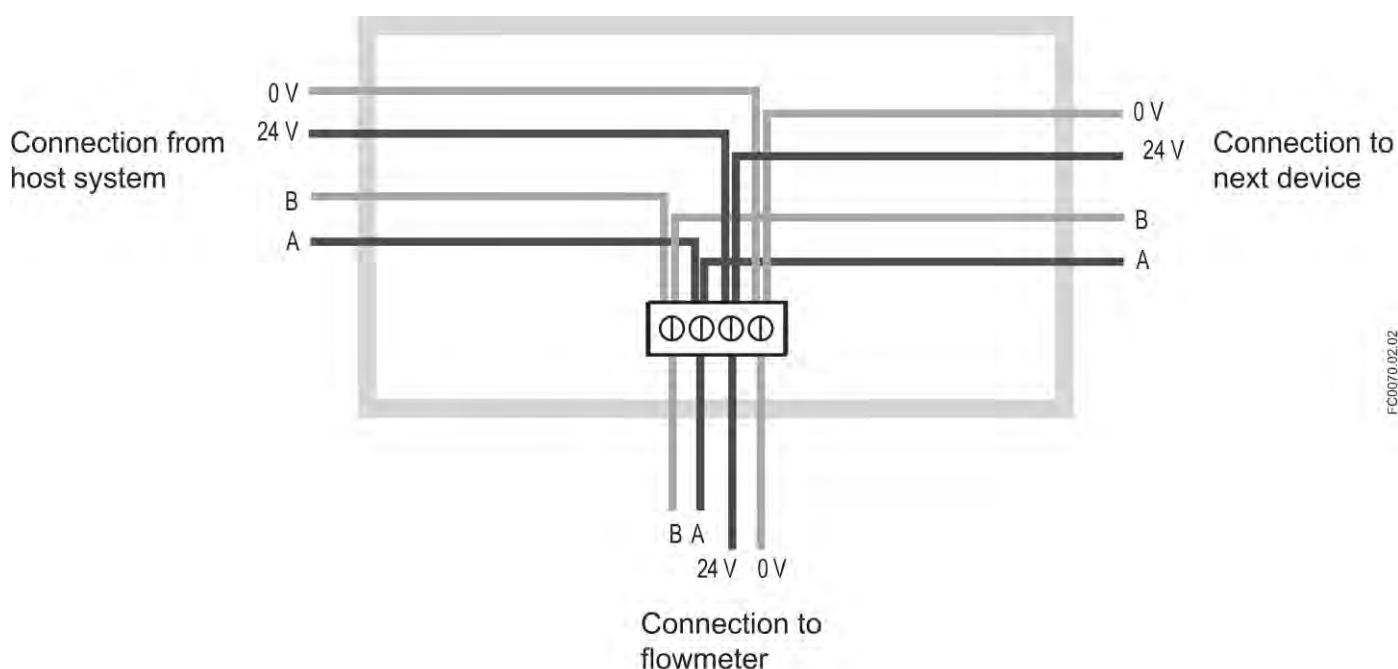

Siemens can supply suitable cable (gray) for non-hazardous area installations in required lengths to be ordered with the system. The cables can be ordered with M12 plugs on both ends or without plug.

Topology

FC410 supports a two-wire electrical interface in accordance with EIA/TIA-485 standard.

An RS485 Modbus configuration without repeater has one trunk cable, along which devices are connected, directly (daisy chaining) or by short branch cables.

Note

Multidrop examples in this document show a trunk cable with short branch cables.

Maximum cable lengths

The end to end length of the trunk cable must be limited. The maximum length depends on the baud rate, the cable (gauge, capacitance or characteristic Impedance), the number and types of loads on the daisy chain, and the network configuration.

Note

Maximum branch cable length

Branch cables must be short, never more than 20 m.

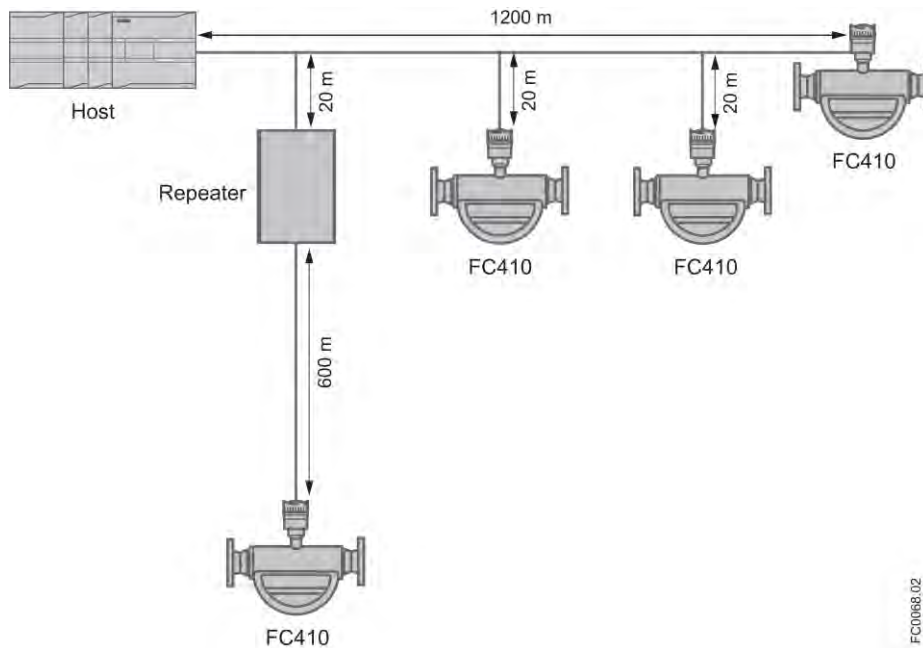

Figure 5-11 Maximum cable lengths in multidrop configuration

Commissioning

6.1 General requirements

Before commissioning it must be checked that:

- The device has been installed and connected in accordance with the guidelines provided in Installing/Mounting (Page 27) and Connecting (Page 39).
- Device installed in hazardous area meets the requirements described in Installation in hazardous locations (Page 16).

6.2 Warnings

 WARNING
<p>Improper handling</p> <p>The sensor connected to this device can be operated with high pressure and corrosive media. Therefore improper handling of the device can lead to serious injuries and/or considerable material damage.</p>

 WARNING
<p>Commissioning and operation with pending error</p> <p>If an error message appears, correct operation in the process is no longer guaranteed.</p> <ul style="list-style-type: none"> • Check the gravity of the error. • Correct the error. • If the error still exists: <ul style="list-style-type: none"> – Take the device out of operation. – Prevent renewed commissioning.

6.3 Operating via SIMATIC PDM

SIMATIC PDM is a software package used to commission and maintain process devices. Further information can be found at: www.siemens.com/simatic-pdm (www.siemens.com/simatic-pdm).

6.4 Functions in SIMATIC PDM

SIMATIC PDM monitors the process values, alarms and status signals of the device. It allows you to display, compare, adjust, verify, and simulate process device data; also to set schedules for calibration and maintenance.

Parameters are identified by name and organized into function groups. See Modbus addressing model (Page 121) for a table and Changing parameter settings using SIMATIC PDM (Page 63) for more details.

See Parameters accessed via drop-down menus (Page 64) for parameters that do not appear in the menu structure in SIMATIC PDM.

Note

Supported SIMATIC PDM versions

The EDD supporting this product is compatible with SIMATIC PDM v. 6.0 + SP5 + HF5 through 8.0 + SP2.

6.5 Commissioning steps

In the following it is described how to commission the device with SIMATIC PDM.

The steps are divided into the following sections:

1. Initial setup (Page 52)
2. Adding device to the communication network (Page 54)
3. Configuring a new device (Page 55).
4. Wizard - Quick start with PDM (Page 56)
5. Wizard - Zero point adjustment (Page 62)

6.6 Initial setup

To ensure that SIMATIC PDM connects properly, please complete the two processes outlined below:

1. Deactivating buffers
2. Updating the Electronic Device Description (EDD)

Deactivating buffers for RS 485 com port

This deactivation is required to align SIMATIC PDM with the Modbus modem for Windows® operating systems.

Note

Support for Windows operating systems can be found here:
support.automation.siemens.com (<http://support.automation.siemens.com>)

1. Click "Start/Settings/Control Panel" to begin configuration.
2. Double click "System", select the "Hardware" tab, and click the "Device Manager" button.
3. Open "Ports" folder and double click the COM Port used by the system to open the "Communications Port Properties" window.
4. Select the "Port Settings" tab and double click the "Advanced" button.
5. If the "Use FIFO buffers" check box is selected, click to deselect.

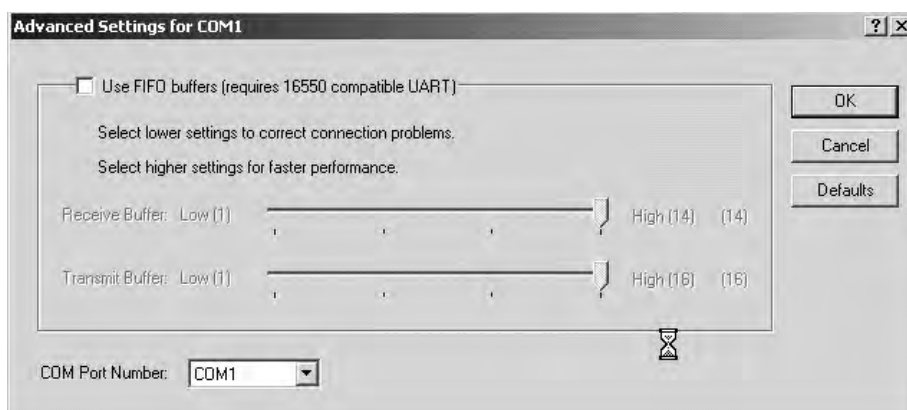

6. Click "OK" to close out. Close all screens and then reboot.

Updating the Electronic Device Description (EDD)

You can locate the EDD in Device Catalog, under "Sensors/Flow/Coriolis/Siemens AG/SITRANS FC410". Check the product page of our website at: www.siemens.com/FC410, under Downloads, to make sure you have the latest version of SIMATIC PDM, the most recent Service Pack (SP) and the most recent hot fix (HF).

Installing a new EDD:

1. Download the EDD from the product page of our website at: www.siemens.com/FC410 and save the files to your computer.
2. Extract the zipped file to an easily accessed location.
3. Launch "SIMATIC PDM – Manage Device Catalog", browse to the unzipped EDD file and select it.

6.7 Adding device to communication network

Before setting the parameters, it is necessary to configure the FC410 project in PDM.

1. Add the device to SIMATIC Modbus network:
 - Select "File"->"New"
Type in a project name, for example FC410 commissioning.
 - Right click on "Net" and select "Insert New Object"->"Modbus Net".
Your PC is now added to the Modbus Net.
 - Right click on "Modbus Net" and select "Insert New Object"->"Modbus Device".
 - Click on "Assign", assign the Modbus device to FC410 (Sensors->Flow->Coriolis->SIEMENS AG->SITRANS FC410) and click "OK".

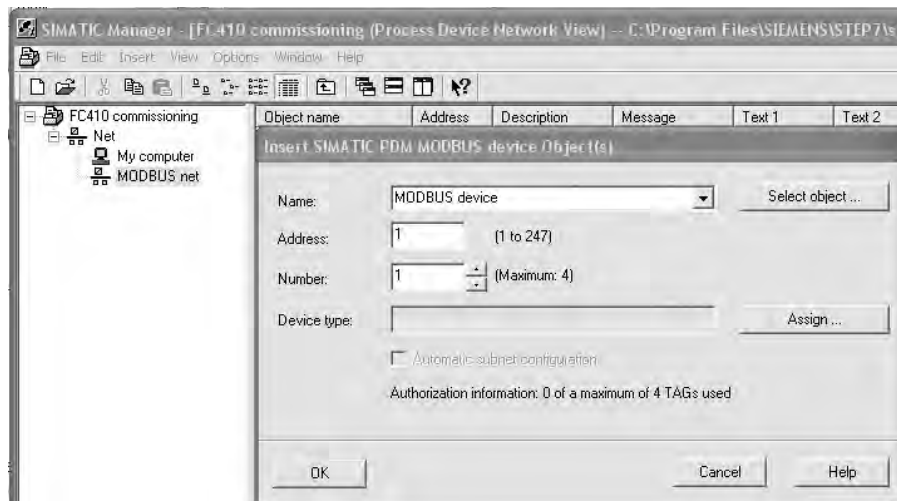

Figure 6-1 Assigning Modbus device to network

2. Set up the communication parameters for SIMATIC Modbus network:
 - Select "Net"->"Modbus net", right click on "Modbus net" and select "Object Properties"
 - Select "Connection" and configure the communication parameters. FC410 default settings are:
 - Data transmission rate: 19200 baud
 - Vertical parity position: 0 - even

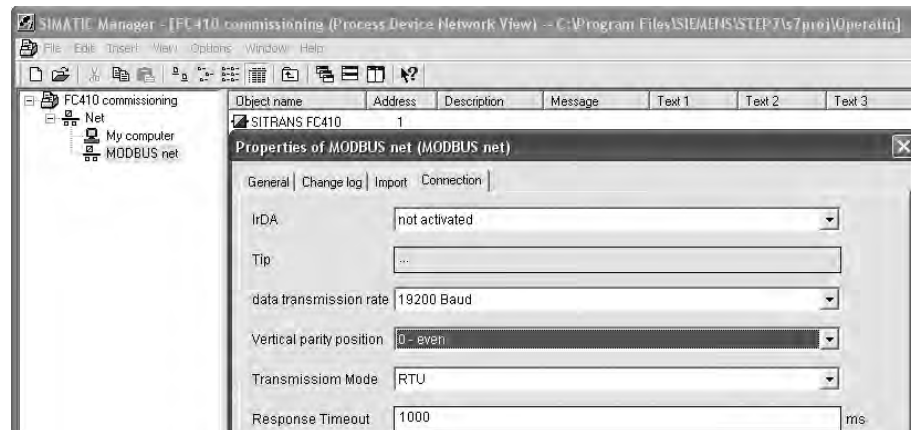

Figure 6-2 Modbus net object properties

3. Set up the COM interface:

- Select "Net" → and double-click on the computer name, for example "My computer".
- Right-click on "COM interface" and select "Object Properties"
- Select "Network" and ensure it is set to "MODBUS net".
- Select "Connection" and configure the COM port.

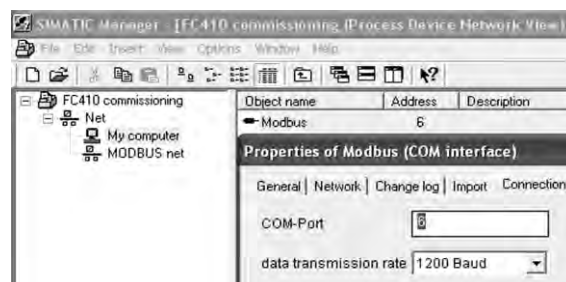

Figure 6-3 Set the com port

6.8 Configuring a new device

Note

Clicking on "Cancel" during an upload from device to SIMATIC PDM will result in some parameters NOT being updated.

1. Check that you have the most recent EDD, and if necessary update it, see Updating the Electronic Device Description (EDD) in Initial setup (Page 52).
2. Launch "SIMATIC PDM – Manager Device Catalog", browse to the unzipped EDD file and select it.
3. Launch SIMATIC Manager and create a new project for FC410.
4. After the reset is complete, upload parameters to the PC/PG.

- 5. Enter user PIN code, see Access level control (Page 56).
- 6. Configure the device via the Wizard Quick Start.

6.9 Wizard - Quick Start via PDM

The graphic Quick Start Wizard provides an easy 5-step procedure that configures the device for a simple application.

Please consult the SIMATIC PDM operating instructions or online help for details on using SIMATIC PDM.

- 1. If you have not already done so, check that you have the most up-to-date Electronic Device Description (EDD) for your instrument, see Configuring a new device (Page 55).
- 2. Launch SIMATIC Manager and create a new project for FC410. (Application Guides for setting up Modbus devices with SIMATIC PDM can be downloaded from the product page of our website at: www.siemens.com/FC410).

Access level control

The parameters are protected against changes by access level control. To gain access, select "Access Management" from the device menu, select "User" and enter the PIN code.

The default user PIN code is "2457".

Quick start

Note

- The Quick Start wizard settings are inter-related and changes apply only after you click on "Apply and Transfer" at the end of step 5 to save settings offline and transfer them to the device.
- Do not use the Quick Start Wizard to modify individual parameters.
- Click on "Back" to return and revise settings or "Cancel" to exit the Quick Start.

Launch SIMATIC PDM, open the menu "Device – Wizard - Quick Start", and follow steps 1 to 5.

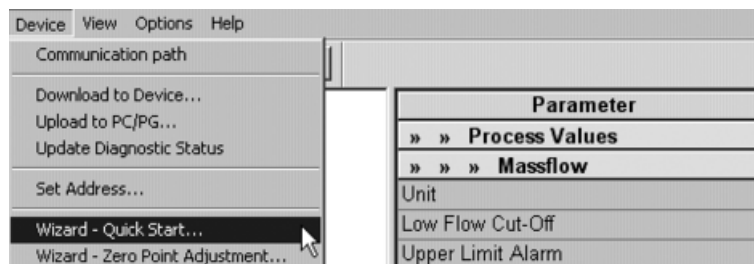

Step 1 - Identification

Note

The layout of the dialog boxes shown may vary according to the resolution setting for your computer monitor. The recommended resolution is 1280 x 960.

1. Click on "Read Data from Device" to upload Quick Start parameter settings from the device to the PC/PG and ensure PDM is synchronized with the device.
2. If required, change the language for the local user interface.
3. Click on "Next" to accept the default values. ("Descriptor", "Message", and "Date" fields can be left blank.)

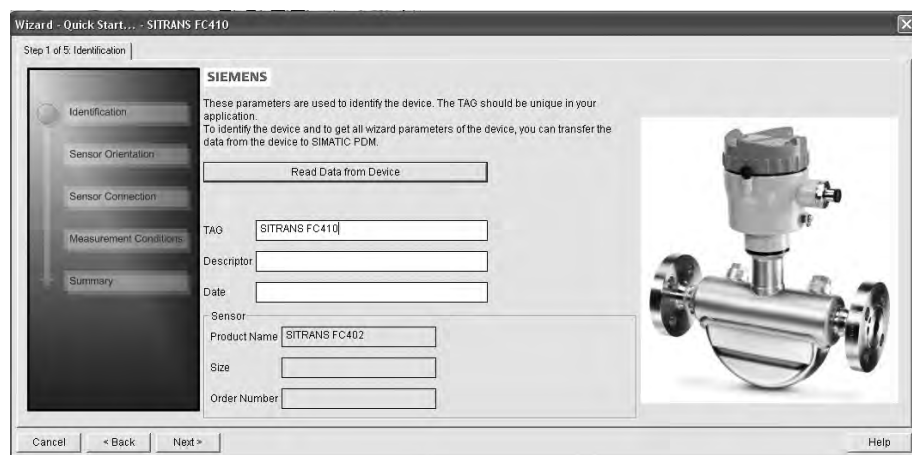

Figure 6-4 Quick start step 1

Step 2 - Sensor orientation

Select the application type (gas or liquid) and sensor orientation, then click on "Next".

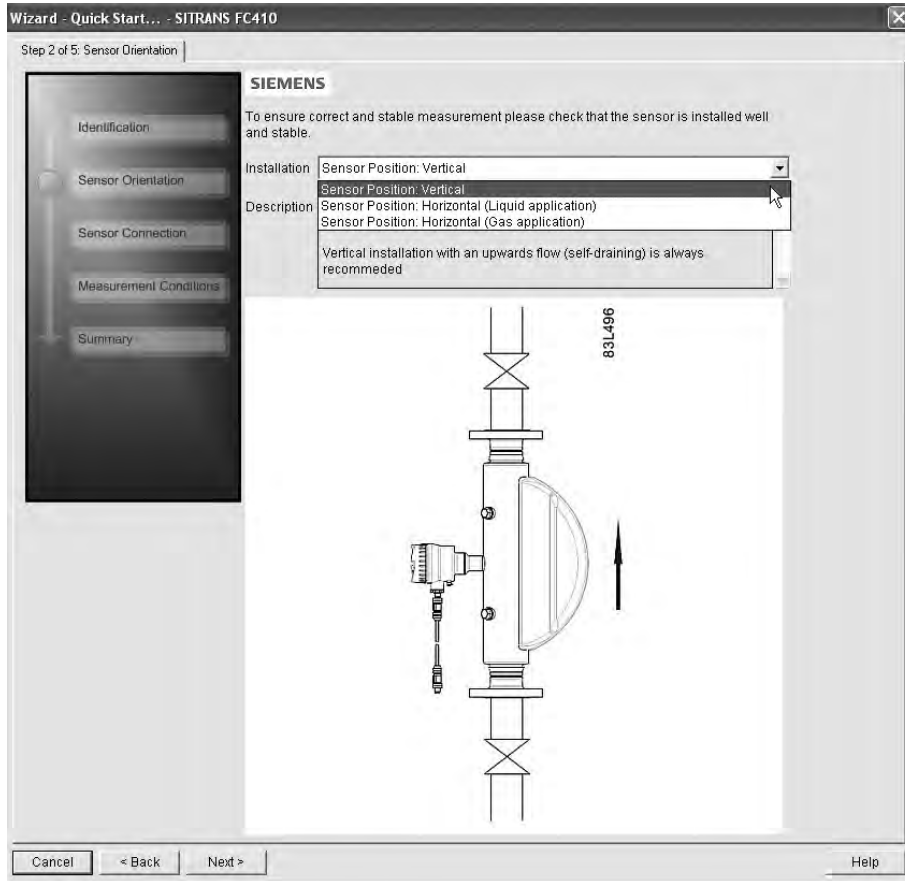

Figure 6-5 Quick start step 2

Step 3 - Sensor connection

An FC410 can be ordered with M12 connection or with terminated cable (for example conduit connections)

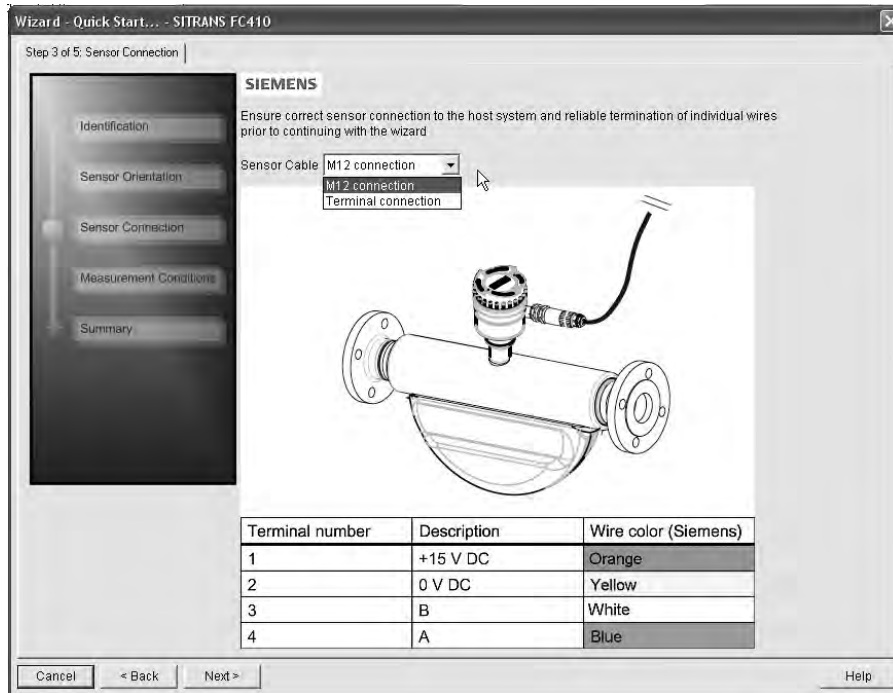

Figure 6-6 Quick start step 3

Step 4 - Measurement conditions

Configure the measurement conditions for the selected process variables. Change "Flow Direction" if necessary.

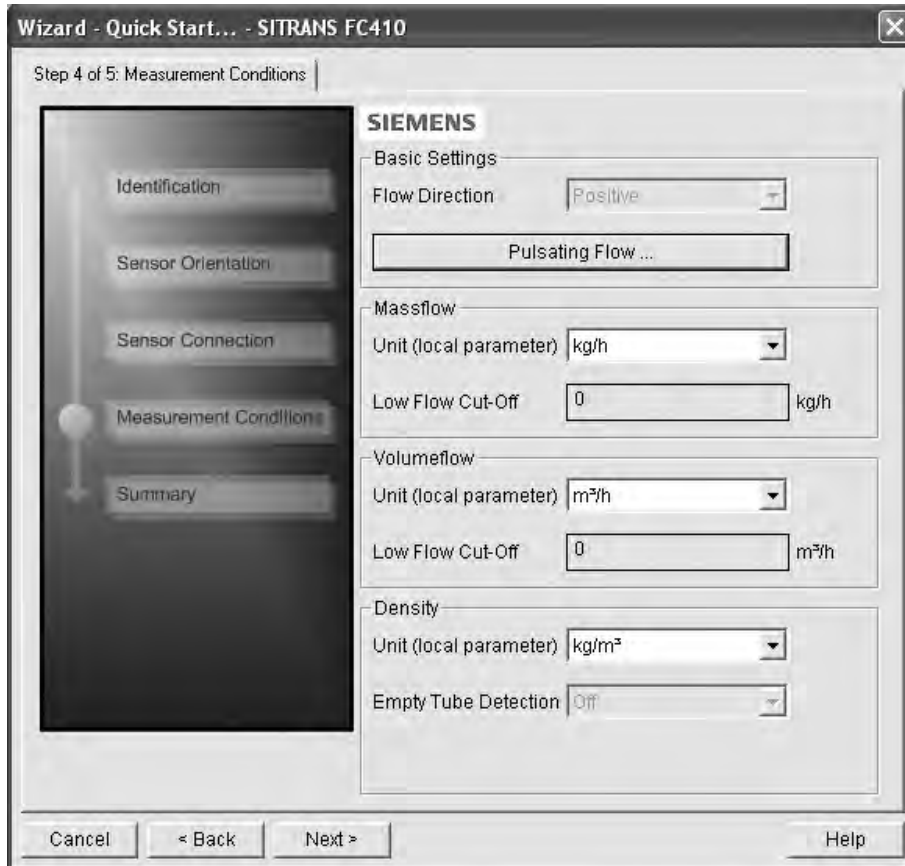

Figure 6-7 Quick start step 4

Reduce the sensitivity of the flow measurement signal by clicking on the "Pulsating Flow" button and selecting the appropriate filter.

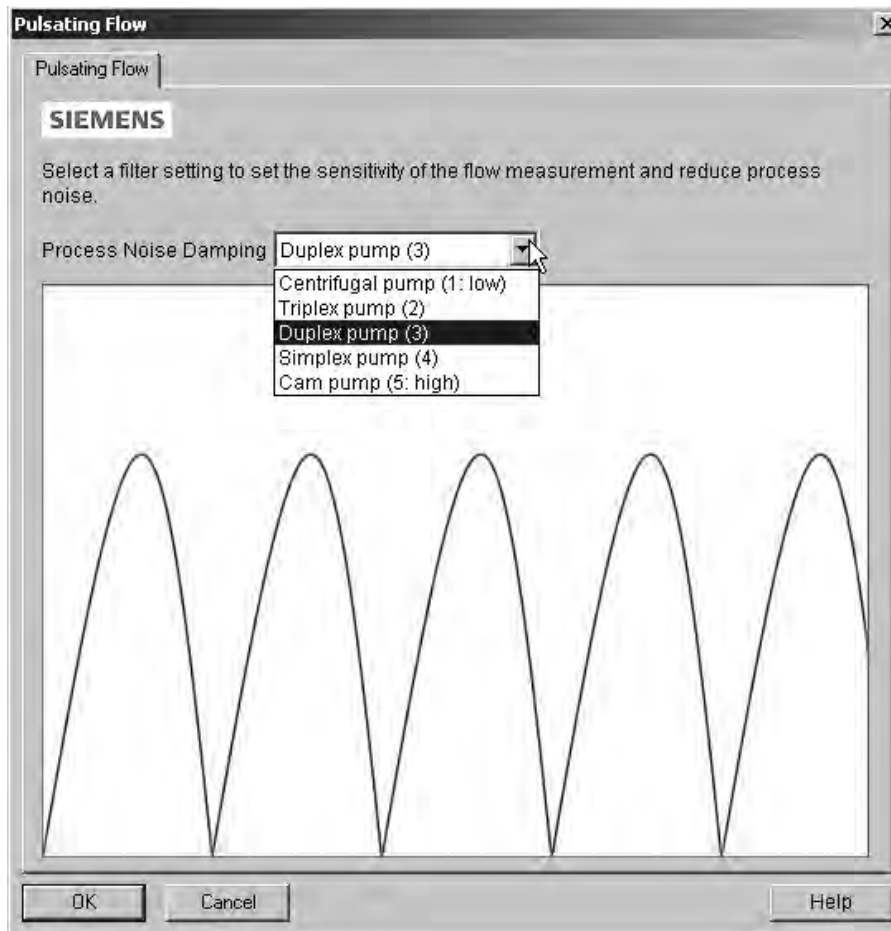

Figure 6-8 Filter setting selection

Step 5 - Summary

Check parameter settings, and click on "Back" to return and revise values, "Apply" to save settings offline, or "Apply and Transfer" to save settings offline and transfer them to the device.

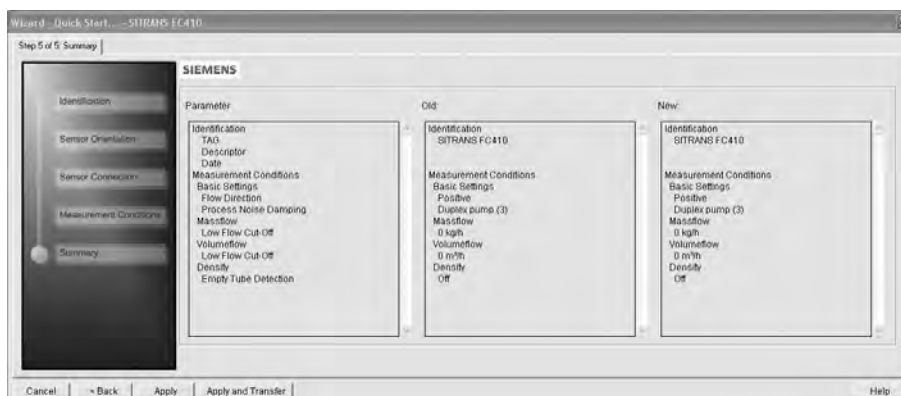
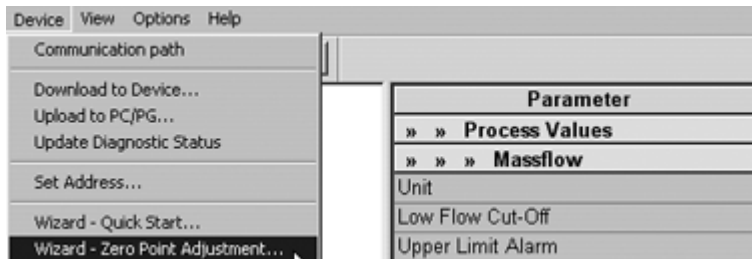

Figure 6-9 Quick start step 5

The message "Quick Start was successful" will appear. Click on "OK".

6.10 Wizard - Zero Point adjustment

Open the menu Device – Wizard - Zero Point Adjustment.



Select "Auto". Click on "Next".

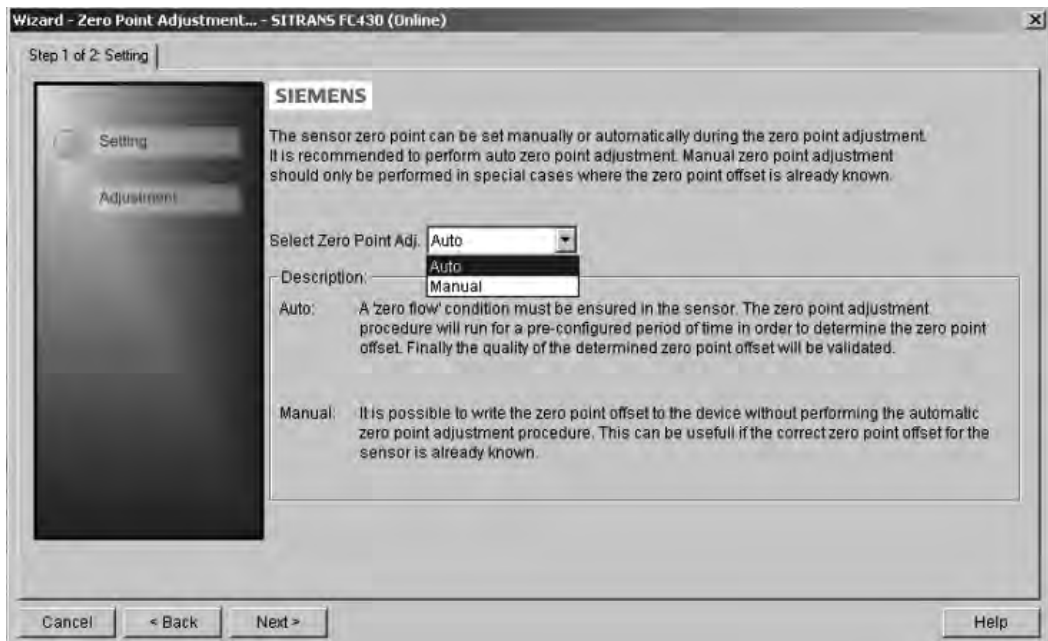

It is recommended to use the default settings. Change the "Zero Point Adjustments Settings", if necessary.

Click on "Auto Zero Point Adjustment".

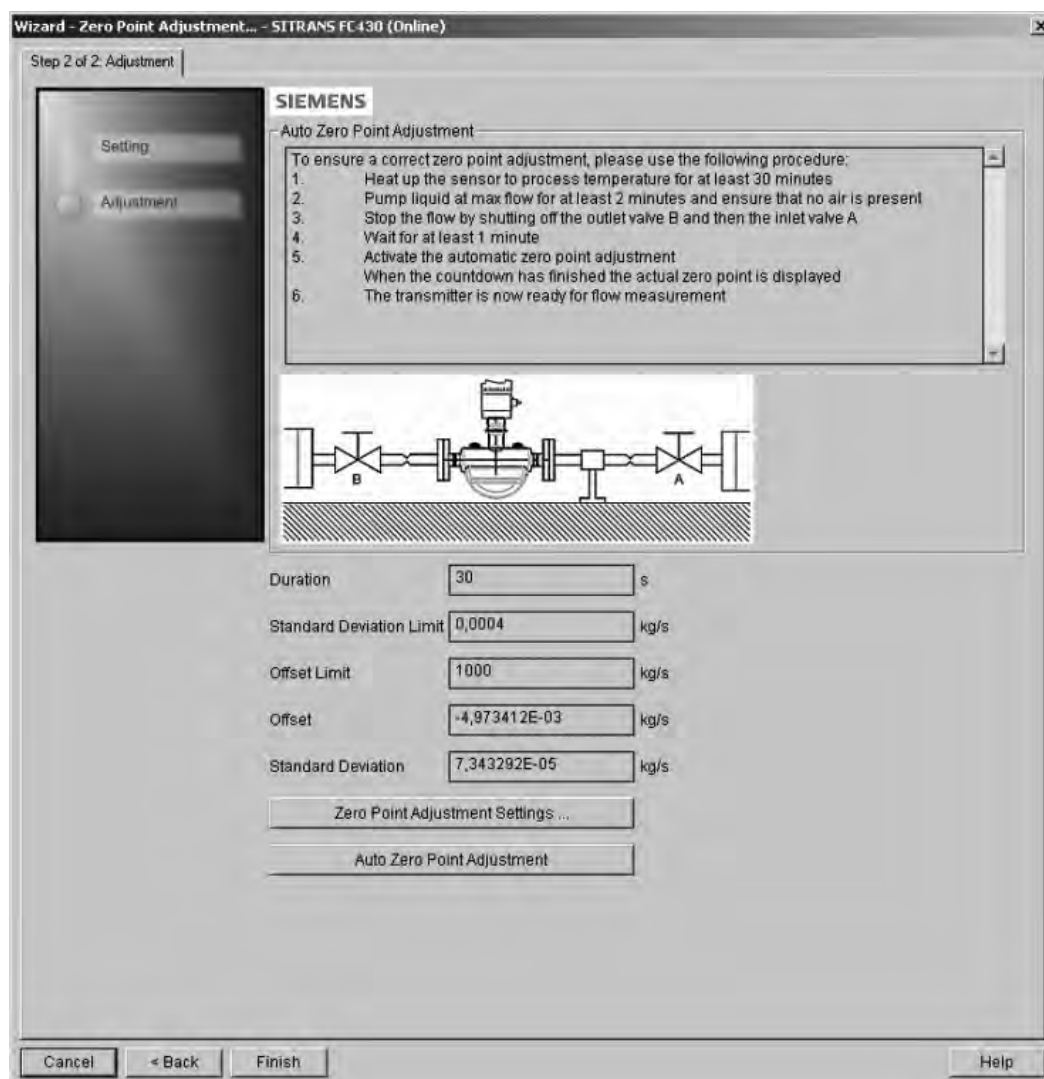

6.11 Changing parameter settings using SIMATIC PDM

Note

For a complete list of parameters, see the Modbus addressing model (Page 121).

Clicking on "Cancel" during an upload from device to SIMATIC PDM will result in some parameters NOT being updated.

Many parameters are accessed via the online menus in PDM, see Parameters accessed via drop-down menus (Page 64) for the others.

6.12 Parameters accessed via drop-down menus

1. Launch SIMATIC PDM, connect to the appropriate device and upload data.
2. Adjust parameter values in the parameter value field then click on "Enter". The status fields read "Changed".
3. Open the "Device" menu, click on "Download to device", then use "File – Save" to save settings offline. The status fields are cleared.

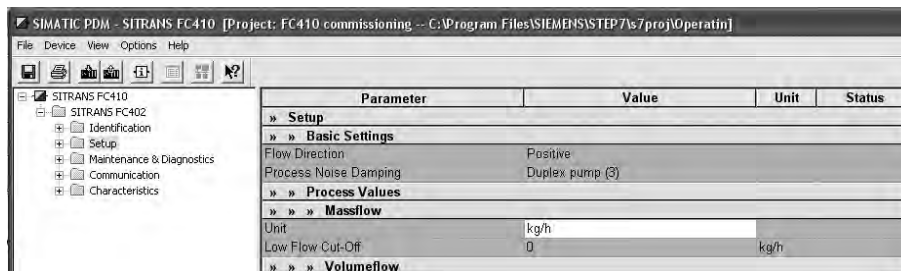

6.12 Parameters accessed via drop-down menus

Click on "Device" or "View" to open the associated drop-down menus.

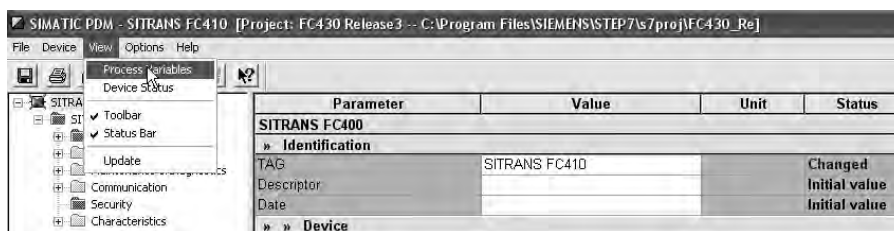

Drop-down menus

Table 6- 1 Device menus

Device menus	Description
Communication Path	Shows the communication interface (Modbus RTU)
Download to Device	Downloads all writable parameters to the device
Upload to PC/PG	Uploads all parameters from the device to the parameter table
Update Diagnostic Status	Reads current diagnostic status from the device and updates the diagnostic status icon
Communication	Sets communication parameters, for example baud rate
Wizard - Quick Start	Guide for a quick commissioning
Wizard - Zero Point Adjustment	Guide for zero point adjustment (automatic and manual)
Totalizer (online dialog)	Controlling massflow totalizer
Maintenance (online dialog)	Setup of maintenance functions
Simulation (online dialog)	Simulation of process values
Access Management	Possibility to upgrade access level from "user" to "expert" and to change PIN code for "expert" level

Table 6- 2 View menus

View menus	Description
Process Variables (online dialog)	Shows all process values
Device Diagnostic (online dialog)	Shows all diagnostics information (alarms and diagnostics parameters)
Toolbar (online dialog)	Shows/hides the toolbar
Status Bar	Shows/hides the status bar
Update	Updates the content of the active window

6.13 Zero point adjustment

The flowmeter system is optimized through a zero point adjustment.

Performing a zero point adjustment

Note

Preconditions

Before a zero point adjustment is initiated, the pipe must be flushed, filled and at an absolute flowrate of zero preferably also at operating pressure and temperature.

6.13 Zero point adjustment

1. Flush out any gases and obtain stable temperature conditions by running flow at operational conditions for minimum 30 minutes.

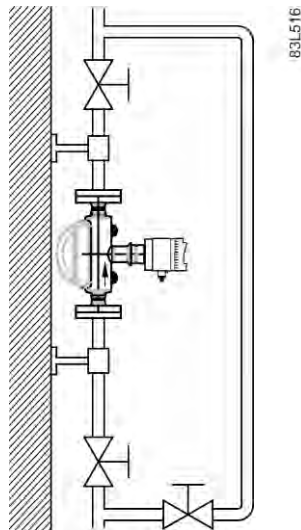
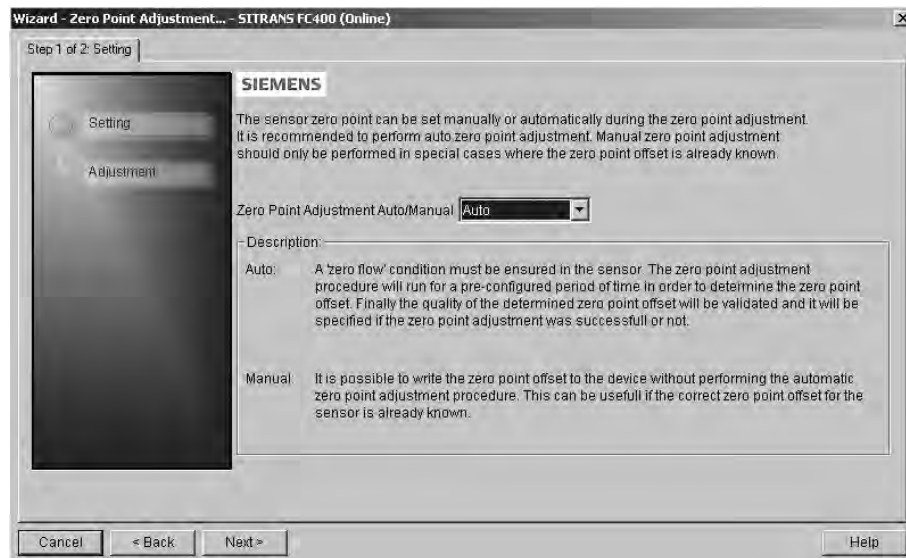

Figure 6-10 Best practice zero point adjustment with a by-pass line and two shut-off devices

2. Close the outlet shut-off valve while maintaining the system pressure. If bypass flow is necessary, open the bypass valve. If the pressure can be increased by 1 to 2 bars with stopped flow, this should be applied.
3. Wait 1 to 2 minutes, for the system to settle, and then perform zero adjustment. Waiting longer can change the temperature.
4. Select "Device->Wizard - Zero Point Adjustment" from the main menu of SIMATIC PDM to perform an automatic zero point adjustment.



5. Click "Next" and then "Auto Zero Point Adjust".

6. During the process a progress bar is visible.
7. At the end of the zero adjustment, the outcome is displayed as an offset and a standard deviation.

Note

If zero point adjustment cannot be successfully performed, an alarm message will be reported in PDM. Improve your zero point adjustment and repeat the procedure.

The system is now ready for normal operation.

6.14 Process variables

1. To compare outputs in real time select "View->Process variables" to see all process values, totalizers and loop current.
2. Verify that the process values show the expected values.

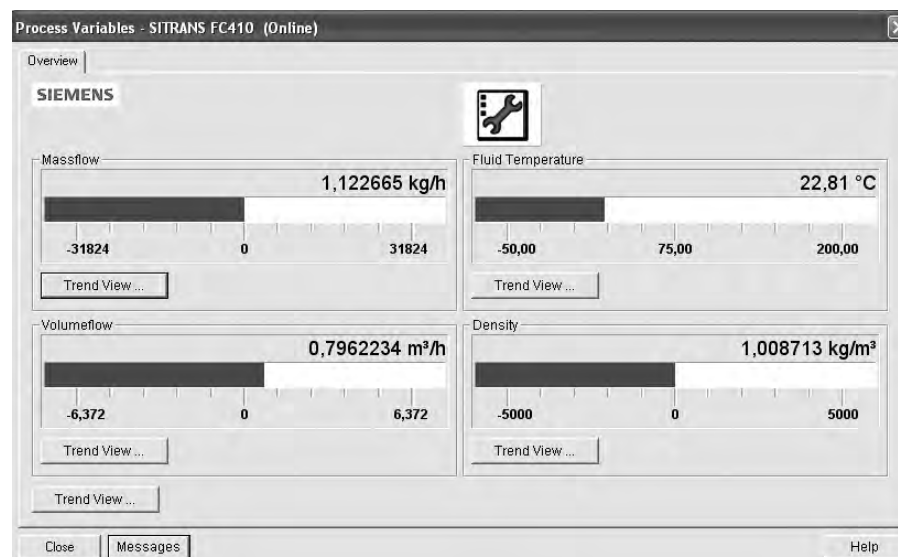

Figure 6-11 Process variables

Trend view

Open the menu "View->Process variables" and click on a "Trend view" button to monitor the trend of one or all process values available at each tab.

In the following the main functionalities of the device are described in detail.

For overview of all functions and parameters, refer to Modbus holding registers (Page 121).

7.1 Process values

According to standard practice with serial communication the Modbus RTU signal reports primary process values and error status strictly with SI units¹⁾ – kilogram, meter, second and degree Celsius.

¹⁾ 1 kg/s of water flow equals 0.001 m³/s of volume flow, and 3600 kg/h.

The process values are updated every 10 ms (100 Hz update rate) synchronous with the DSP update cycle.

Process value parameters

The process values are:

- Massflow (MassflowValue) [kg/s]
- Volumeflow (VolumeflowValue) [m³/s]
- Density (Density) [kg/m³]
- Process media temperature (FlowMediaTemp) [°C]

7.2 Zero point adjustment

In the following the automatic zero point adjustment function is described. For further details, see Zero point adjustment (Page 65).

Note

Preconditions

Before a zero point adjustment is initiated, the pipe must be flushed, filled and at an absolute flowrate of zero preferably also at operating pressure and temperature. Refer to Zero point adjustment (Page 145) for more details.

Note

Change of parameters during zero point adjustment

Do not change any other parameter during the zero point adjustment procedure.

Automatic zero point adjustment

The device measures and calculates the correct zero point automatically.

The automatic zero point adjustment of the flowmeter is set by the following parameters:

- Duration (Modbus address 2135)
- Start Zero Point Adjustment (Modbus address 2180)

When zero adjust is initiated by selecting "Start Zero Point Adjustment", the massflow values are acquired and totalized for the configured period (Duration). The default zero point adjustment period (30 s.) is normally sufficient for a stable zero point measurement.

Note

Extremely low flow quantity

If the flow quantity is extremely small, extremely precise measurement is necessary. In this case, a long zero point adjustment period can be selected for improved zero point adjustment.

Zero point calculation

During zero point adjustment, an average value is automatically calculated using the following formula:

Zero Point Offset Value

Average of N flow values

$$\bar{x} \equiv \frac{\sum_{i=1}^N x_i}{N}$$

x_i is an instantaneous flow value sampled in the time domain

N = Number of samples during zero point adjustment

The offset value must be within the determined "Zero Point Offset Limit" (Modbus address 2140).

Note

Exceeded zero point offset limit

If the offset value is greater than the configured limit, proceed as follows:

- Check that the tube is completely filled and that the flowrate is absolute zero.
 - Check the validity of the configured zero point offset limit.
 - Repeat the zero point adjustment.
-

Zero point standard deviation

After completion of the procedure, the standard deviation is calculated in accordance with the following formula:

Zero Point Standard Deviation

Standard deviation of N values

$$s \equiv \sqrt{\frac{\sum_{i=1}^N (x_i - \bar{x})^2}{N-1}} = \sqrt{\frac{-N\bar{x}^2 + \sum_{i=1}^N x_i^2}{N-1}}$$

The standard deviation contains important feedback on the homogeneity of the fluid, for example on the presence of bubbles or particles.

The standard deviation must be within the determined "Standard Deviation Limit" (Modbus address 2138).

Note

Exceeded standard deviation limit

If the standard deviation is greater than the configured limit, proceed as follows:

- Check that the tube is completely filled and that the flow rate is absolute zero.
 - Check that the installation is vibration-free.
 - Check the validity of the configured standard deviation limit in parameter 2.6.4 "Standard deviation limit".
 - Repeat the zero point adjustment.
-

Successful automatic zero point adjustment

If the new zero point offset value is valid, it is automatically stored as the new zero point for the sensor. It remains stored in the case of a power failure.

Manual zero point adjustment

In case an automatic zero point adjustment cannot be performed, it is possible to do a manual zero point adjustment by entering the zero point offset value.

1. Select Modbus address 2132 "Zero Point Adjustment" and set the value to 1 = "Manual Zero Point Adjustment".
2. Select Modbus address 2133 "Manual Zero Point Offset" and enter the desired offset value.

7.3 Low flow cut-off

In certain applications, as for instance batching applications, no flow signals under a certain flow level are desired. In these applications, the flow signal can be forced to zero, when the flow is lower than a predefined flow value (Low Flow Cut-Off).

SITRANS FC410 provides two parameters for setting the low flow cut-off:

- Low Mass Flow Cut-Off (Modbus address 2125)
- Low Volume Flow Cut-Off (Modbus address 2170)

7.4 Empty tube monitoring

The empty tube monitoring function uses the process density for detecting an empty tube. Use of this function is recommended for all standard applications.

Note

Gas applications

Deactivate the empty tube monitoring function.

Empty tube monitoring parameters

Two parameters for setting the empty tube monitoring function are available:

- Empty Tube Detection (Modbus address 2129)
- Empty Tube Limit (Modbus address 2127)

The empty tube monitoring is activated via the Empty Tube Detection parameter. When the empty tube monitoring function is on, the massflow / volumeflow value is forced to zero if the tube is empty.

The tube is defined as empty, if the measured density value is lower than the value defined via the Empty Tube Limit parameter.

Note

Process media density

Risk of unintentionally forcing flow values to zero, if the difference between the empty tube limit density value and the density of the process media is not sufficient.

- Ensure sufficient difference between the empty tube limit density value and the process media density
-

7.5 Process noise damping

Noise damping function

The dynamic sensitivity of the flow measurement signal to rapid changes in process flows can be reduced by use of the process noise damping function. The function is typically used in environment with:

- Strongly pulsating flow
- Changing pump speeds
- Large pressure variations

Process noise damping settings

Reduce interfering process noise by increasing the setting of the parameter "Process Noise Damping" (Modbus address 2130).

- Centrifugal pump (1: low)
- Triplex pump (2)
- Duplex pump (3)
- Simplex pump (4)
- Cam pump (5: high)

The default value is "Duplex pump". The damping affects all functions and outputs of the sensor.

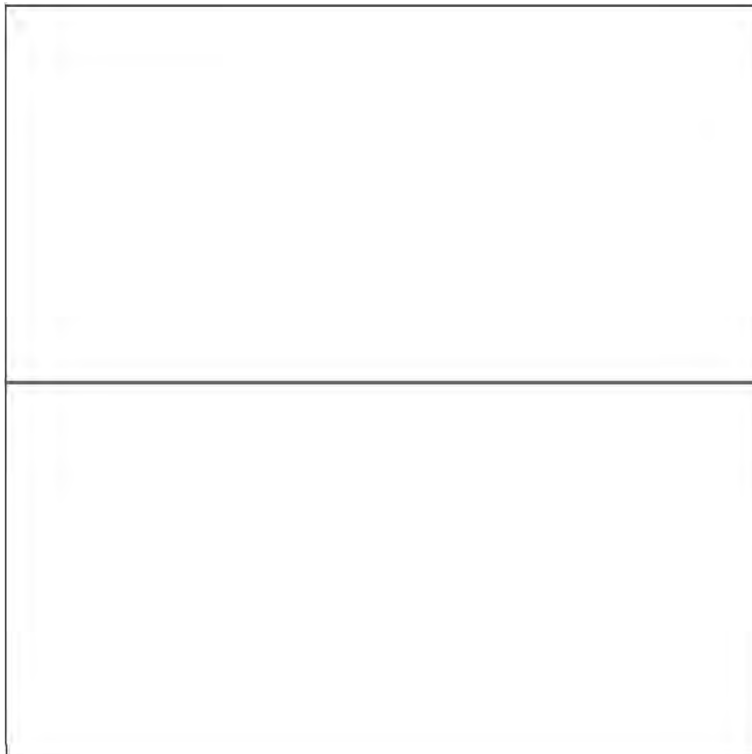

Figure 7-1 Centrifugal pump (1: low)

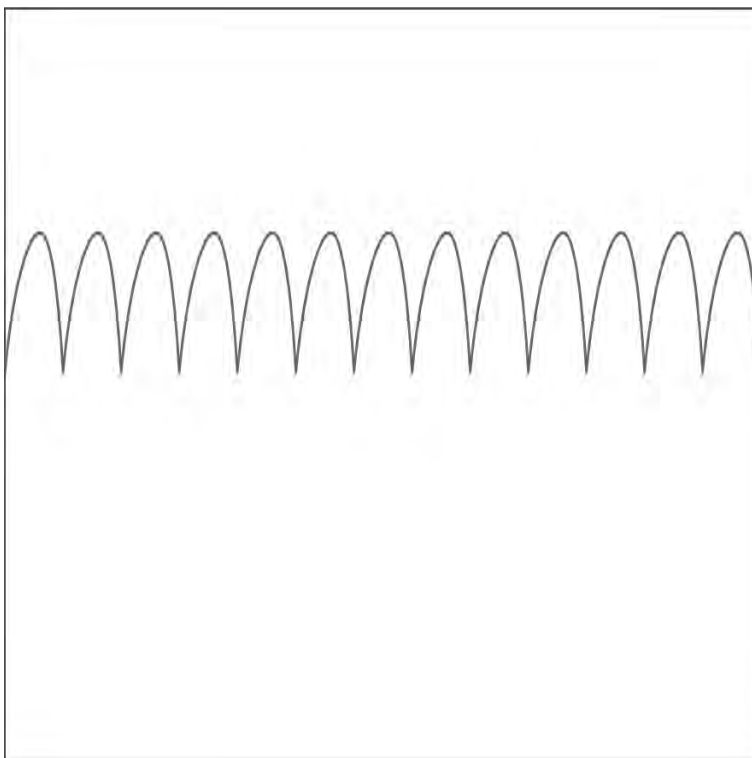

Figure 7-2 Triplex pump (2)

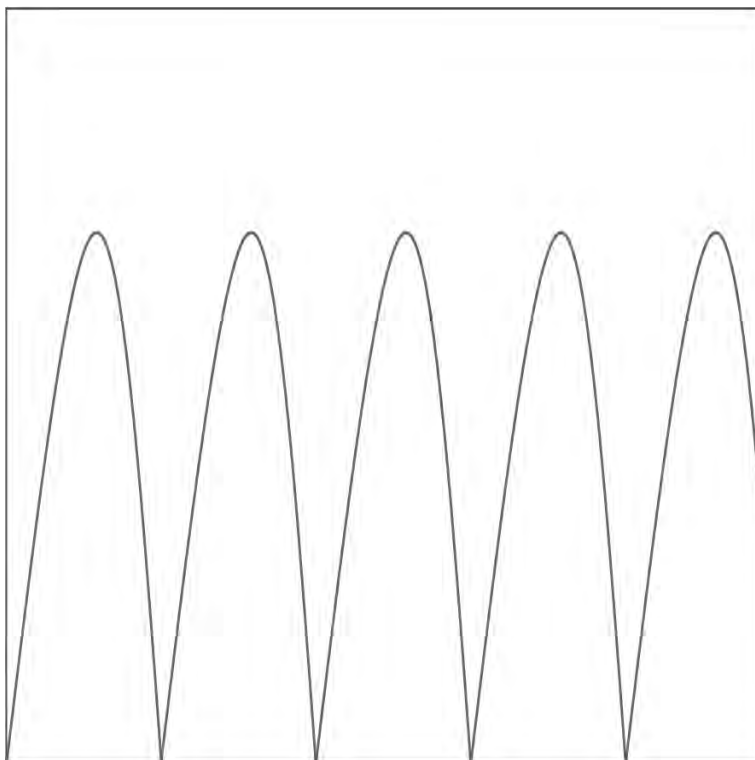

Figure 7-3 Duplex pump (3; default setting)

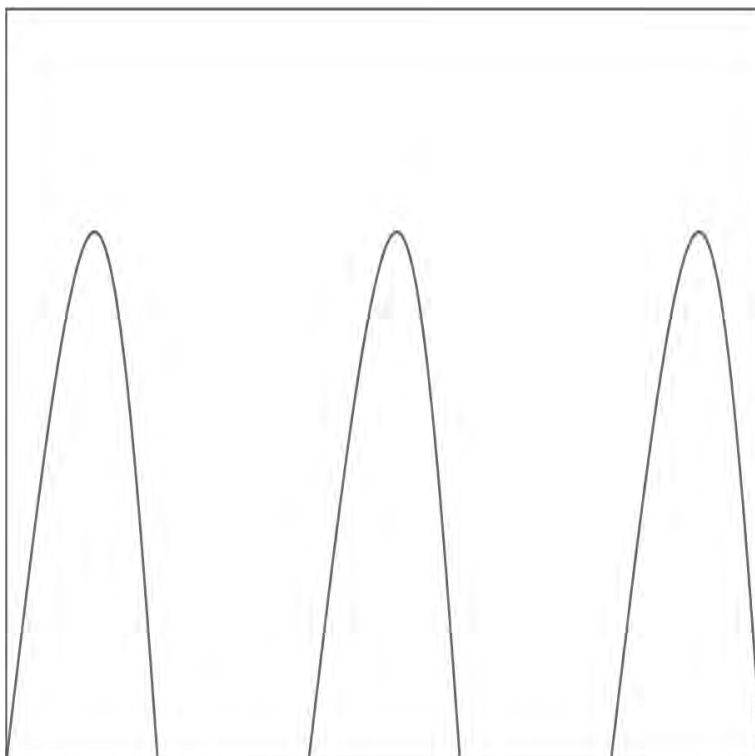

Figure 7-4 Simplex pump (4)

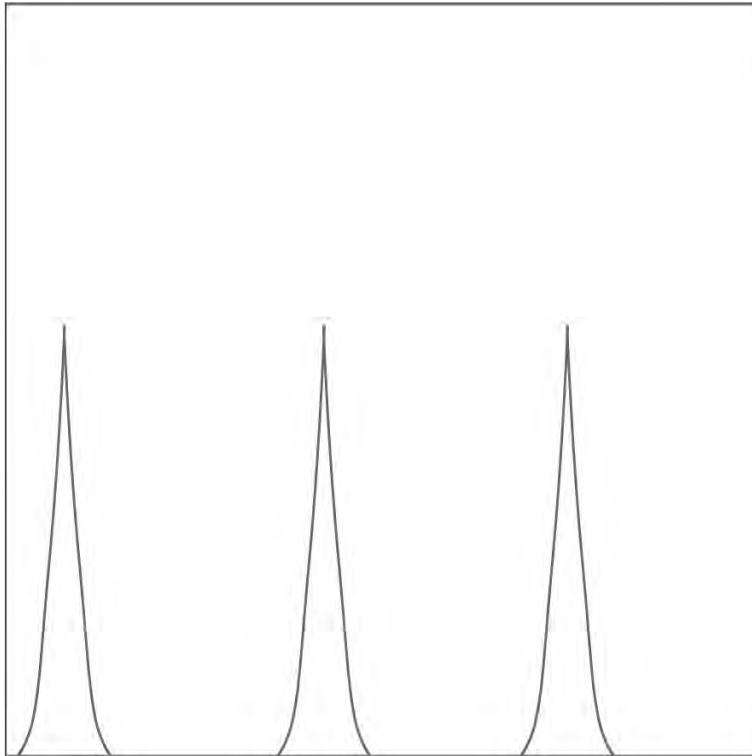

Figure 7-5 Cam pump (5: high)

Note

Increased reaction time

The reaction time of the sensor increases when the process noise is damped.

7.6 Totalizer

Totalizer function

The device has one totalizer function that can be used to totalize the massflow process value.

The totalizer may be paused, resumed or reset:

- Pause (Modbus address 2613): the totalizer holds the last value before the failure occurred
- Resume (Modbus address 2614): the totalizer continues counting the actual measured value
- Reset (Modbus address 2612): the totalizer continues counting based on the last input value (for example massflow) before the failure occurred.

7.7 Access management

All parameters may be viewed, but some are protected against changes by access level control.

The Access Management menu makes it possible to gain access to PIN code protected parameters and to change PIN codes.

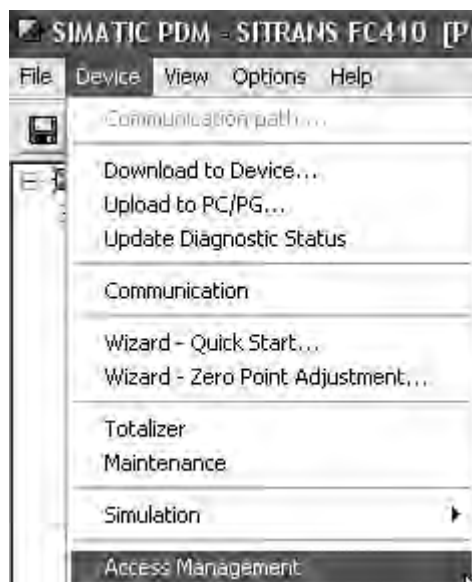

Figure 7-6 Access Management menu

The access levels are:

- Read Only
Allows no configuration. The user is only able to view the parameter values. No PIN code is required.
- User
Allows configuration and service of all parameters except calibration parameters. Default PIN code is 2457.

Note

Auto Log Off function

If no parameter has been written for ten minutes or the device is restarted, the access level is reset to Read Only

7.8 Simulation

Simulation is used for testing purposes, typically for checking that the readings of the control system are correct.

Process value simulation

The following process values can be simulated:

- Massflow (Modbus address 2764)
- Density (Modbus address 2766)
- Process Media Temperature (Modbus address 2768)
- Frame Temperature (Modbus address 2770)
- Volumeflow (Modbus address 2772)

The simulation can be activated through SIMATIC PDM in the menu "Device → Simulation → Process variables".

7.9 Changing Modbus communication settings

Changing communication parameters, for example "Baud Rate", "Modbus Parity Framing" or "Bus Address" effects the Modbus communication as follows:

- The new settings have effect only after a reset, either by restarting the device or writing the value 1 to Modbus address 600 "Restart communication".
- The new settings will not have effect until the Modbus driver has responded to any ongoing Modbus request.

NOTICE
Setting addresses in a multidrop network
It is recommended NOT to use the default address in a multi-drop network. When setting device addresses, make sure that each device has a unique address. Replication of addresses may cause abnormal behavior of the entire serial bus and make the master unable to communicate with all slaves on the bus.

7.10 Float transmission

The Float Byte Order function ensures that the master and slave use the same sequence of the bytes when transmitting float values. This enables the user to configure the FC410 using the configuration tool, SIMATIC PDM, and operate the device with all types of PLCs without reprogramming the PLC. The transmission order is configured by setting the parameter "Byte Order" in the submenu "Device" > "Communication".

Note

The command "Restart Communication" must be executed to activate the new byte order setting.

This table shows the different options for setting the transmission method:

Selection	Sequence			
	1st	2nd	3rd	4th
1 - 0 - 3 - 2	Byte 1 (MMMMMMMM)	Byte 0 (MMMMMMMM)	Byte 3 (SEEEEEEE)	Byte 2 (EMMMMMMM)
0 - 1 - 2 - 3	Byte 0 (MMMMMMMM)	Byte 1 (MMMMMMMM)	Byte 2 (EMMMMMMM)	Byte 3 (SEEEEEEE)
2 - 3 - 0 - 1	Byte 2 (EMMMMMMM)	Byte 3 (SEEEEEEE)	Byte 0 (MMMMMMMM)	Byte 1 (MMMMMMMM)
3 - 2 - 1 - 0 *	Byte 3 (SEEEEEEE)	Byte 2 (EMMMMMMM)	Byte 1 (MMMMMMMM)	Byte 0 (MMMMMMMM)

* = Factory setting
 S = Sign
 E = Exponent
 M = Mantissa

NOTICE
Change of float byte order
If the float byte order is changed by use of PDM to anything other than default, all float values shown in PDM are wrong.

Alarms and system messages

8.1 Alarm messages

In the following tables the bits for alarm group 1 and alarm group 2 can be found along with possible causes and directions for corrective action.

Alarm group 1 (Modbus address 3012)

Bit	Diagnostic	Action
4 5	Sensor supply volt. out of range	Contact Siemens customer support
6 7 8 9	Temperature measurement fault	Contact Siemens customer support
10 11 12 13	Flow values not valid	Can be due to problems with measured fluid or hardware malfunction. If the failure continues then contact Siemens customer support
14	Invalid calibration data	Contact Siemens customer support for recalibration
15	Invalid compensation data	Contact Siemens customer support
17 18	Malfunction in Pickup Amplitude	Contact Siemens customer support
23 24 25	Malfunction in sensor driver	Contact Siemens customer support
26	Unstable driver oscillation	Contact Siemens customer support
27	Massflow out of specification	Reduce the flow. If the failure continues then contact Siemens customer support
28	Volume flow out of specification	Reduce the flow. If the failure continues then contact Siemens customer support
29	Density out of specification	Contact Siemens customer support
30	Fluid temp. below limit	Increase the fluid temperature. If the failure continues then contact Siemens customer support
31	Fluid temp. above limit	Reduce the fluid temperature. If the failure continues then contact Siemens customer support

Alarm group 2 (Modbus address 3014)

Bit	Diagnostic	Action
0	Frame temp. below limit	Increase fluid temperature and check that ambient temperature is within specified limits. If the failure continues then contact Siemens customer support
1	Frame temp. above limit	Reduce fluid temperature and check that ambient temperature is within specified limits. If the failure continues then contact Siemens customer support
2	"Standard Deviation" above limit (shown for only 2 seconds)	Measurement continues with values from last successful zero point adjustment. Improve conditions for automatic zero point adjustment and repeat adjustment.
3	"Zero Point Offset" above limit (shown for only 2 seconds)	Measurement continues with values from last successful zero point adjustment. Improve conditions for automatic zero point adjustment and repeat adjustment.
4	Zero point adjustment failed (shown for only 2 seconds)	Measurement continues with values from last successful zero point adjustment. Improve conditions for automatic zero point adjustment and repeat adjustment.
5	"Empty Tube Limit" exceeded	Make sure that the sensor is filled with liquid and that the liquid density is within the specified "Empty Tube Limit"
6	Too little fluid in tube	Make sure that the sensor is filled with liquid
7	Parameter storage malfunction	Turn off the power, wait 5 seconds and turn on the power again. If the failure continues then contact Siemens customer support
8 9 10 11 12 13	Internal error in sensor	Contact Siemens customer support
14	Unstable measurement condition	Check if air is present in the liquid and that the flowmeter is operated within its specifications
15	Auto filtering	Check that the flowmeter is operated within its specifications. Check other alarms to rule out HW malfunction
23	The sensor is stabilizing	Turn off the power, wait 5 seconds and turn on the power again. If the failure continues then contact Siemens customer support.

Service and maintenance

9.1 Maintenance

The device is maintenance-free. However, a periodic inspection according to pertinent directives and regulations must be carried out.

An inspection can include check of:

- Ambient conditions
- Seal integrity of the process connections, cable entries, and cover screws
- Reliability of power supply, lightning protection, and grounds

NOTICE
Repair and service must be carried out by Siemens authorized personnel only.

Note

Siemens defines flow sensors as non-repairable products.

9.2 Maintenance information parameters

The basic maintenance parameters are:

- Operating Time Total (Since first power-up)
- Operating Time Since Power Up (Since latest power-up)

9.3 Service information

Service information is information about the condition of the device used for diagnostics and service purposes.

Service information parameters

The basic service information parameters are:

- Driver Current
- Pickup 1 Amplitude
- Pickup 2 Amplitude
- Sensor Frequency
- Frame Temperature

9.4 Recalibration

- Process Media Temperature
- Zero Point Adjustment Auto/Manual
- Zero Point Offset Value
- Manual Zero Point
- Zero Point Standard Deviation

9.4 Recalibration

Siemens A/S, Flow Instruments offers to recalibrate the sensor at our works in Denmark. The following calibration types are offered as standard according to configuration (standard, density, °Brix/°Plato, fraction):

- Standard calibration
- Customer specified calibration
- Accredited Siemens ISO/IEC 17025 calibration
- Density calibration (incl. fraction setup if requested)
- Witness calibration

Note

SensorFlash

For sensor recalibration the SensorFlash memory unit must always be returned with the sensor.

9.5 Technical support

If you have any technical questions about the device described in these Operating Instructions and do not find the right answers, you can contact Customer Support:

- Via the Internet using the **Support Request:**
Support request (<http://www.siemens.com/automation/support-request>)
- Via Phone:
 - Europe: +49 (0)911 895 7222
 - America: +1 423 262 5710
 - Asia-Pacific: +86 10 6475 7575

Further information about our technical support is available on the Internet at Technical support (<http://support.automation.siemens.com/WW/view/en/16604318>)

Service & Support on the Internet

In addition to our documentation, we offer a comprehensive knowledge base online on the Internet at:

Service and support (<http://www.siemens.com/automation/service&support>)

There you will find:

- The latest product information, FAQs, downloads, tips and tricks.
- Our newsletter, providing you with the latest information about your products.
- Our bulletin board, where users and specialists share their knowledge worldwide.
- You can find your local contact partner for Industry Automation and Drives Technologies in our partner database.
- Information about field service, repairs, spare parts and lots more under "Services."

Additional Support

Please contact your local Siemens representative and offices if you have additional questions about the device.

Find your local contact partner at: <http://www.automation.siemens.com/partner>
(<http://www.automation.siemens.com/partner>)

9.6 Transportation and storage

To guarantee sufficient protection during transport and storage, observe the following:

- Keep the original packaging for subsequent transportation.
- Devices/replacement parts should be returned in their original packaging.
- If the original packaging is no longer available, ensure that all shipments are properly packaged to provide sufficient protection during transport. Siemens cannot assume liability for any costs associated with transportation damages.

 CAUTION
--

Insufficient protection during storage

The packaging only provides limited protection against moisture and infiltration.

- | |
|--|
| <ul style="list-style-type: none">• Provide additional packaging as necessary. |
|--|

Special conditions for storage and transportation of the device are listed in "Technical data" (Page 95).

9.7 Device disposal





Devices identified by this symbol may not be disposed of in the municipal waste disposal services under observance of the Directive 2002/96/EC on waste electronic and electrical equipment (WEEE).

They can be returned to the supplier within the EC or to a locally approved disposal service. Observe the specific regulations valid in your country.

9.8 Maintenance work

 CAUTION
Hot surfaces Danger of burns during maintenance work on parts having surface temperatures exceeding 70 °C (158 °F). <ul style="list-style-type: none">• Take corresponding protective measures, for example by wearing protective gloves.• After carrying out maintenance, remount touch protection measures.

 WARNING
Humid environment Danger of electric shock. <ul style="list-style-type: none">• Avoid working on the device when it is energized.• If working on an energized device is necessary, ensure that the environment is dry.• Make sure when carrying out cleaning and maintenance work that no moisture penetrates the inside of the device.

 CAUTION
Dangerous voltage at open device Danger of electric shock when the enclosure is opened or enclosure parts are removed. <ul style="list-style-type: none">• Before you open the enclosure or remove enclosure parts, de-energize the device.• If maintenance measures in an energized state are necessary, observe the particular precautionary measures. Have maintenance work carried out by qualified personnel.

 **WARNING**

Hot, toxic or corrosive process media

Danger of injury during maintenance work.

When working on the process connection, hot, toxic or corrosive process media could be released.

- As long as the device is under pressure, do not loosen process connections and do not remove any parts that are pressurized.
- Before opening or removing the device ensure that process media cannot be released.

Troubleshooting/FAQs

10.1 Diagnosing with PDM

SIMATIC PDM is a suitable tool for diagnosing the device.

You can use SIMATIC PDM to read all available parameters to a table for analyzing offline, view online/actual process values and online/actual diagnostic information.

Requirements

The following procedure must be completed before diagnosing:

- Installation of PDM and PDM device driver
- Connection of Modbus interface.

Refer to Commissioning (Page 51).

Diagnosing with PDM

Online process values are available under menu "View->process values".

Online diagnostic information is available under menu "View->Device Status"

10.2 Troubleshooting

Incorrect and unstable measurements, especially at low flows, are typically a result of an unstable zero point due to:

- Incorrect installation
- Bubbles in the liquid
- Vibrations/Cross talk
- Solid particles settling in the liquid

In the following a 4-step guide to troubleshooting is provided:

- | | |
|--------|------------------------------------|
| Step 1 | Preliminary application inspection |
| Step 2 | Zero point adjustment |
| Step 3 | Measurement error calculation |
| Step 4 | Application improvement |

The guide will enable you to trace the reason for incorrect measurements and to improve the application.

10.2.1 Step 1: Inspecting the application

Ensure that:

1. The sensor is installed as described in "Installing/mounting" (Page 27).
2. The sensor is located in a vibration-free position. Vibrations can disturb the sensor and therefore cause measurement error.

Depending on application, you should furthermore ensure the following:

- Liquid application
Ensure that the sensor is filled with liquid and liquid only.
Air or gas bubbles in the liquid cause instability and can result in measurement errors.
Flush the pipe systems and the sensor for several minutes at maximum flowrate to remove any air bubbles which may be present.

Note

The liquid must be homogeneous in order to measure with high accuracy. If the liquid contains solid particles of greater density than the liquid, then these solids can settle, especially at low flow rates, which will cause instability in the sensor and lead to measurement errors.

For pastes or process fluids with suspended solids always orient the sensor vertically with flow in upward direction to maintain solids suspension.

- Gas application
Ensure that the gas pressure/temperature conditions contain sufficient superheat to prevent dewing or precipitation. If the gas contains vapor or droplets then these may precipitate, causing instability.

10.2.2 Step 2: Performing a zero point adjustment

The second step in the troubleshooting procedure is to zero point adjust the device. For further information on zero point adjustment, see "Commissioning" (Page 51).

10.2.3 Step 3: Calculating the measurement error

The result of the zero point adjustment will show you if the zero point was set under good and stable conditions.

The lower the obtained value of the parameter "Zero Point Standard Deviation", the lower is the achievable measuring error. For a well-installed flowmeter, the Zero Point Standard Deviation corresponds to the specified zero point stability for the sensor size, see "Performance (Page 97)".

The parameter "Zero Point Standard Deviation" is located in the "Maintenance & Diagnostics" menu in the SIMATIC PDM.

Calculating the measurement error

Given the Zero Point Standard Deviation, the error expected for different flow rates can be calculated, without performing time-consuming measurements. So using this formula, one can assess if the application can be used as-is, or whether to use more time improving the installation.

$$E = Z \times 100 \% / Q_m$$

Where:

E = measurement error in % of flowrate

Z = zero point standard deviation value in kg/h

Q_m = current flowrate in (kg/h)

Example 1: Low flow application

- DN 15 sensor. The sensor's nominal flowrate is specified to 3700 kg/h
- Zero point error (Zero Point Standard Deviation) value is specified as 0.2 kg/h
- Flow: Min. 10 kg/h - Max. 100 kg/h

After the zero point adjustment, the Zero Point Standard Deviation value 'Z' is read as 1 kg/h, that is 5 times greater than that specified for the sensor.

The error for a flowrate of 10 kg/h is estimated as:

- $E = 1 \text{ kg/h} \times 100\% / 10 \text{ kg/h} = 10\%$.

For a flowrate of 100 kg/h the error is estimated as:

- $E = 1 \text{ kg/h} \times 100\% / 100 \text{ kg/h} = 1\%$

For this application it is necessary to investigate more closely what the cause of the relatively high Zero Point Standard Deviation value is, in order to establish what needs to be done to improve the measurement accuracy.

Example 2 : High flow application

DN 15 sensor. The sensor flowrate is specified as max. 3700 kg/h

- The zero point error/ Zero Point Standard Deviation value is specified as 0.2 kg/h
- Flowrate: Min. 1000 kg/h - Max. 3000 kg/h

After the zero point adjustment, the Zero Point Standard Deviation value 'Z' is read as 1 kg/h, that is 5 times greater than specified for the sensor !

The error at a flowrate of 1000 kg/h is estimated as:

- $E = 1 \text{ kg/h} \times 100\% / 1000 \text{ kg/h} = 0.1\%$

At a flowrate of 3000 kg/h the error is estimated to be:

- $E = 1 \text{ kg/h} \times 100\% / 3000 \text{ kg/h} = 0.03\%$
Plus the linearity error of 0.1%

As can be seen, in this case it is not so important that the standard deviation is 1 kg/h. The error due to the zero point is only 0.1% for a flowrate of 1000 kg/h, and even less for a higher flowrate.

So for this installation with the given flowrate and zero point error (Zero Point Standard Deviation value), you should typically choose not to spend more time finding ways to improve the application.

See also

Maintenance & Diagnostics (Page 132)

10.2.4 Step 4: Improving the application

In the following it is described how to find the causes of a high Zero Point Standard Deviation and how to improve the installation.

Setting Low Flow Cut-Off

In order to see if the zero point becomes more stable when making changes / adjustments, the Low Mass Flow Cut-Off (MassFlowCutOff) must be set to 0.0%.

When Low Flow Cut-Off has been set, it is possible to see the instability directly from the massflow in the online window ("View → Process variables")

This information can be used to troubleshoot. For example, tightening the brackets which hold the sensor, or turning off the pump to check if vibrations from the pump are disturbing the sensor, etc.

Incorrect installation of the sensor

- Has the sensor been correctly installed, that is fastened to the floor / wall or frame with good mounting brackets as shown in the instructions?

Especially for low flowrates, that is flowrates less than 10% of the maximum capacity of the flow meter, it is important that the sensor is correctly and stably installed.

If the sensor is not correctly fixed in place, the zero point of the sensor will change, leading to measuring errors.

Try to tighten up the sensor brackets to see whether the flow instability is reduced.

Vibrations and cross talk

Vibrations in the pipe system are normally generated by pumps.

Typically, cross talk is generated by two sensors positioned in close proximity in the same pipe, or installed upon the same rail or frame.

Vibrations / cross talk have a greater or lesser effect upon the zero point stability and therefore also the measurement accuracy.

1. Check whether there are vibrations.
Turn off the pump and check whether the zero point stability improves, that is if the flowrate fluctuation in kg/h is reduced.
If the sensor is disturbed by vibration from the pump, the installation should be improved or the pump should be exchanged, for example to another type.
2. Check for cross talk.
Turn off the power to the other flow meter(s) and wait approximately 2 minutes, so the vibrating tubes in the sensor have stopped vibrating. Then check if the zero point stability has improved, that is that the fluctuation in kg/h has been reduced. If this is the case, the sensors disturb one another and the installation should be improved.

Air in the liquid

When air is present in the liquid, the zero point becomes unstable, which leads to a poor measurement accuracy.

Checking for air:

- Check the Driver Current (View → Device Diagnostics → Advanced Diagnostic)
- Check if the Driver Current varies more than ± 1 mA. If this is the case, it is usually due to the presence of air or gas bubbles in the liquid.
- Increase the pressure in the sensor, creating a large back pressure upon the sensor by reducing the opening of the outlet valve or by increasing the pump pressure. Thereby the size of air bubbles inside the sensor will be minimized. If the value or the stability of Driver Current falls, it is proof that the liquid contains air or gas bubbles.

Typical causes of air in the liquid

- The entry pipe and sensor have not been properly filled with liquid.
- The pump cavitates, the rotary speed of the pump is too high in relation to the supply of liquid to the pump.
- The flow rate in the pipe is too high, so components sitting in front of the flowmeter can cause cavitation.
- If there is a filter installed before the flowmeter, it may be close to blocking, which also can cause cavitation.
- Liquid flashes to vapor bubbles while passing through partially open valves or orifices.

Solid particles in the liquid

If the solid particles in a liquid have a density higher than that of the liquid, they can precipitate inside the sensor and cause instability which leads to a measurement error.

If solid particles are present in the liquid, they must be homogeneously distributed and have similar density as the liquid. Otherwise they can cause relatively large measurement errors.

It is important that the sensor is installed such that solid particles can easily run out of the sensor.

1. Ensure that the sensor is installed vertically with an upwards flow.
2. Check if solid particles are present in the liquid:
Take a sample of the liquid, fill a glass and see if the solids precipitate.

Technical data

11.1 Function and system design

Table 11- 1 Designated use

Description	Specification
Measurement of process media	<ul style="list-style-type: none"> Fluid Group 1 (suitable for dangerous fluids) Aggregate state: Paste/light slurry, liquid and gas

Table 11- 2 Function and system design

Description	Specification
Measuring principle	Coriolis
System architecture	<ul style="list-style-type: none"> Point-to-point (1 Modbus RTU master - 1 FC410 slave) Multidrop (1 Modbus RTU master - up to 31 FC410 slaves)

11.2 Process variables

Table 11- 3 Process variables

Description	Specification			
Primary process variables	<ul style="list-style-type: none"> Massflow Density Fluid temperature 			
Derived process variable	<ul style="list-style-type: none"> Volumeflow 			
Measurement range (water)	DN 15 (½")	DN 25 (1")	DN 50 (2")	DN 80 (3")
Massflow* kg/h (lb/h)	±20 to ±6400 (±44 to ±14 100)	±200 to ±17 700 (±440 to ±39 000)	±750 to ±70 700 (±1650 to ±156 000)	±900 to ±181 000 (±1980 to ±399 000)

11.3 Modbus Communication Specification

Description	Specification
Volumeflow* m ³ /h (gpm)	±0.02 to ±6.4 (±0.088 to ±28.2) ±0.2 to ±17.7 (±0.88 to ±77.9) ±0.75 to ±70.7 (±3.3 to ±311) ±0.9 to ±181 (±4.0 to ±797)
Density	Up to 5000 kg/m ³ (312 lb/ft ³)
Process media temperature	-50 to +200 °C (-58 to 392 °F)
Pressure	1 to 160 bar depending on the connections, sensor material, pressure approval and process temperature

*: Flowrates below minimum values in the table are measured and reported without accuracy guarantee being applied.

11.3 Modbus Communication Specification

Table 11- 4 Modbus communication specification

Description	Specification
Device type	Slave
Baud rates	<ul style="list-style-type: none"> • 9600 • 19 200 (Factory setting) • 38 400 • 57 600 • 76 800 • 115 200
Number of stations	Recommended: max. 31 per segment without repeaters
Device address range	1 to 247
Protocol	Modbus RTU
Electrical interface	RS 485, 2-wire
Connector type	M12 / Cable termination
Supported function codes	<ul style="list-style-type: none"> • 3: read holding registers • 16: write multiple registers • 8: diagnostics
Broadcast	No ¹⁾
Maximum cable length [m]	600 meters (@ 115 200 bits/sec)
Standard	Modbus over serial line v 1.0 ²⁾
Certification	None
Device Profile	None

1): Standard restriction. The standard requires a LED indicator for visual diagnosis. This device does not support a LED indicator. Instead comprehensive display information is available. This device does not react to any Broadcast commands.

2): According to the Specification & Implementation guide v. 1.0 available at the Modbus Organization website

Note

Storage location

All Modbus settings of the device are stored in a non-volatile memory.

11.4 Performance

Table 11- 5 Reference conditions

Description	Specification
Process media	Water
Process media temperature	20 °C (68 °F)
Ambient temperature	25 °C (77 °F)
Process media pressure	2 bar (29 psi)
Process media density	0.997 g/cm ³ (62.2 lb/ft ³)
Reference device orientation	Horizontal installation, tubes down, flow in direction of arrow on casing, see "Installing/Mounting" (Page 27).

Table 11- 6 Massflow accuracy

Description	Specification			
	DN 15	DN 25	DN 50	DN 80
Sensor size				
Nominal flowrate [kg/h] (lb/h)	3700 (8157)	11 500 (25 353)	52 000 (114 640)	136 000 (299 828)
Max. zero point stability [kg/h]	±0.2	±2.0	±7.5	±9.0
Measuring accuracy [%]	±0.10 or ±0.15 (as option)			
Repeatability error [%]	±0.05			

Table 11- 7 Density accuracy

Description	Specification
Density accuracy, standard calibration [kg/m ³]	±5
Density accuracy, extended calibration [kg/m ³]	±1
Density repeatability [kg/m ³]	±0.25
Density, media pressure effect [(kg/m ³)/Bar]	±0.5
Density, media temperature effect [(kg/m ³)/°C]	±0.1

11.5 Rated operating conditions

Table 11- 8 Media temperature accuracy

Description	Specification
Media temperature accuracy [°C]	±1
Media temperature repeatability [°C]	±0.25

Table 11- 9 Additional error by deviations from reference conditions

Description	Specification			
	DN 15	DN 25	DN 50	DN 80
Sensor size				
Effect of process pressure [% of actual flowrate per bar]	±0.015	±0.015	±0.015	±0.015
Effect of process pressure at nominal flowrate [(kg/h) per bar]	0.56	1.73	7.8	20.4
Effect of ambient temperature [% / K actual flowrate]	< ±0.003	< ±0.003	< ±0.003	< ±0.003
Display/Frequency/Pulse output:				
Effect of power supply fluctuations	None	None	None	None
Effect of media temperature [(kg/h)/°C]	±0.0875	±0.175	±1.05	±3.15

11.5 Rated operating conditions

Table 11- 10 Basic conditions

Description	Specification
Ambient temperature (°C[°F]) Operation (Humidity max. 90 %)	-40 to +60 [-40 to +140]
Ambient temperature (°C[°F]) Storage (Humidity max. 90 %)	-40 to +70 [-40 to +158]
Climate class	DIN 60721-3-4
Altitude	Up to 2000 m (6560 ft)
Relative humidity [%]	95
Bump resistance	On request
Shock resistance	On request
Thermal shock	On request
Vibration resistance	On request
EMC performance	Emission Immunity
	EN 55011 / CISPR-11 EN/IEC 61326-1 (Industry)

Table 11- 11 Cleaning and sterilizing conditions

Description	Specification
Cleaning method	<ul style="list-style-type: none"> • CIP • SIP
Cleaning temperature	On request
Cleaning frequency	On request
Cleaning duration	On request

Table 11- 12 Process media conditions

Description	Specification
Process media temperature (T_s) (min to max) [°C (F)]	-50 to +200 (-58 to 492)
Process media density (min to max) [kg/m ³ (lb/ft ³)]	1 to 5000 (0.06 to 312)
Process media gauge pressure (min to max) [bar (psi)]	0 to 160 (0 to 2321)
Process media absolute pressure (min to max) [bar (psi)]	Stainless steel: 1 to 101 (14.5 to 1465) Hastelloy: 1 to 161 (14.5 to 2335)
Process media viscosity	Gases and non-compressible liquids
Pressure drop	See Pressure drop curves (Page 99)
Pressure temperature ratings	See Pressure - temperature ratings (Page 100)

11.6 Pressure drop curves

The pressure drop is dimension-dependent and influenced by process media viscosity and density. Sensors with undersized process connections experience higher pressure drop due to reduction in inlet/outlet dimensions.

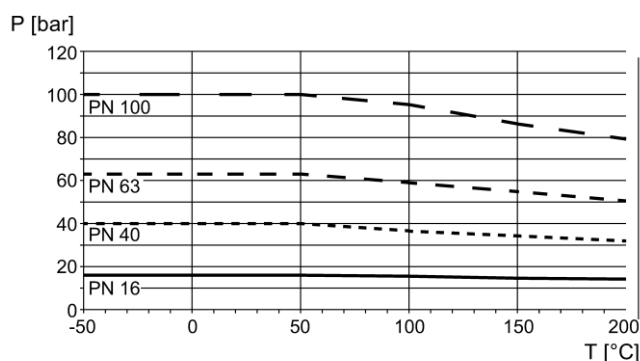

Figure 11-1 Metric flange ratings, EN 1092-1 (P: Process pressure; T: Process temperature)

11.7 Pressure - temperature ratings

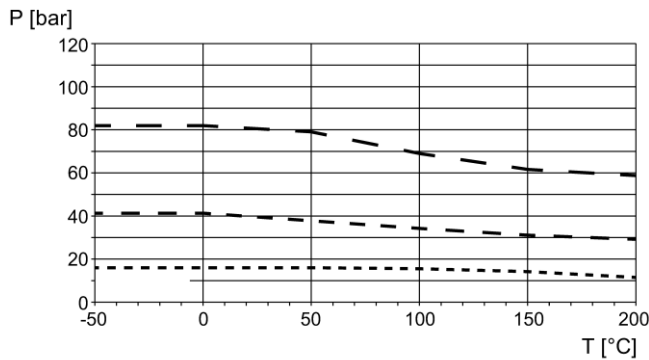

Figure 11-2 ANSI flange ratings, ASME B16.5 (P: Process pressure; T: Process temperature)

11.7 Pressure - temperature ratings

Pressure - temperature ratings are determined by process connection material and applicable standards. The tables below detail the allowed maximum process pressure for sensor variants with stainless steel and Hastelloy measuring tubes.

With two major exceptions, the pressure rating of the flow sensors is independent of the process medium temperature. Design rules for flange connections in both the EN1092-1 and ASME B16.5 standards dictate pressure derating with increasing temperature. The charts below show the effect of process medium temperature on the pressure ratings for the flanges within the product program.

11.7.1 Stainless steel sensors

Table 11- 13 EN1092-1 [bar]

PN (bar)	Temperature TS (°C)					
	-50	0	50	100	150	200
16	16.0	16.0	16.0	15.2	13.8	12.7
40	40.0	40.0	40.0	37.9	34.5	31.8
63	63.0	63.0	63.0	59.7	54.3	50.1
100	100.0	100.0	100.0	94.8	86.2	79.5
160	100.0	100.0	100.0	100.0	100.0	100.0

Table 11- 14 ISO228-G and ASME B1.20.1 NPT [bar]

PN (bar)	Temperature TS (°C)					
	-50	0	50	100	150	200
100	100.0	100.0	100.0	100.0	100.0	100.0

Table 11- 15 ASME B16.5 [bar]

Class / Group	Temperature TS (°C)					
	-50	0	50	100	150	200
150 / 2.3	15.8	15.8	15.3	13.3	12.1	11.1
300 / 2.3	41.3	41.3	39.8	34.8	31.4	29.0
600 / 2.3	82.6	82.6	79.7	69.6	62.9	58.1
900 / 2.3	100	100	100	100	94.2	87.5

Table 11- 16 JIS [bar]

PN (bar)	Temperature TS (°C)					
	-50	0	50	120	150	200
10K	14	14	14	14	13.4	12.4
20K	34	34	34	34	33.1	31.6
40K	68	68	68	68	66.2	63.2
63K	100	100	100	100	100	99

Table 11- 17 DIN 11851 [bar]

PN (bar) / DN	Temperature TS (°C)				
	-50	0	50	100	140
25 / 50-100	25	25	25	25	25
40 / 10-40	40	40	40	40	40

Table 11- 18 DIN 32676 & ISO 2852 [bar]

PN (bar) / DN	Temperature TS (°C)				
	-50	0	50	100	140
10 / 85-219.1	10	10	10	10	10
16 / 48.3-76.2	16	16	16	16	16
25 / 6.35-42.4	25	25	25	25	25

Table 11- 19 DIN 11864 & ISO 2853 [bar]

PN (bar) / DN	Temperature TS (°C)				
	-50	0	50	100	140
25 / 50-100	25	25	25	25	25
40 / 10-40	40	40	40	40	40

Table 11- 20 Swagelok SS-12-VCO-3 socket weld with SS-12-VCO-4 nut [bar]

PN (bar)	Temperature TS (°C)					
	-50	0	50	100	150	200
100	100.0	100.0	100.0	100.0	100.0	100.0

Note

Test pressure

Maximum allowable test pressure (MATP) for the flowmeter and process connection is 1.5 times the nominal pressure up to 150 bar (2176 psi).

11.7.2 Hastelloy sensors

Table 11- 21 EN1092-1 [bar]

PN (bar)	Temperature TS (°C)					
	-50	0	50	100	150	200
16	16.0	16.0	16.0	16.0	16.0	16.0
40	40.0	40.0	40.0	40.0	40.0	40.0
63	63.0	63.0	63.0	63.0	63.0	63.0
100	100.0	100.0	100.0	100.0	100.0	100.0
160	160.0	160.0	153.0	145.0	134.0	125.0

Table 11- 22 ISO228-G and ASME B1.20.1 NPT [bar]

PN (bar)	Temperature TS (°C)					
	-50	0	50	100	150	200
100	100.0	100.0	100.0	100.0	100.0	100.0
160	160.0	160.0	153.0	145.0	134.0	125.0

Table 11- 23 ASME B16.5 [bar]

Class	Temperature TS (°C)					
	-50	0	50	100	150	200
150	20.0	20..	19.5	17.7	15.8	13.8
300	51.7	51.7	51.7	51.5	50.3	48.6
600	103.4	103.4	103.4	103.0	100.3	97.2
900	155.1	155.1	153.0	145.0	134.0	125.0

Table 11- 24 DIN 11851 [bar]

PN (bar) / DN	Temperature TS (°C)				
	-50	0	50	100	140
25 / 50-100	25	25	25	25	25
40 / 10-40	40	40	40	40	40

11.8 Design

Table 11- 25 Design

Description	Specification
Dimension and weight	See "Dimensions and weight" (Page 115)
Process connectors	<ul style="list-style-type: none"> • EN1092-1 B1, PN16, PN40, PN63, PN100, PN160 • EN1092-1 D (gasket groove), PN40, PN63, PN100, PN160 • ISO 228-1 G * • ASME B1.20.1 NPT * • ASME B16.5, CI 150, CI 300, CI 600, CI 900 • DIN 11851 ** • DIN 32676 * • DIN 11864-1A **, DIN 11864-2C (inch) **, DIN 11864-3A ** • ISO 2852 ** • ISO 2853 ** • JIS B 2220, 10K, 20K, 40K, 62K
Electrical connection	<ul style="list-style-type: none"> • M12 connector with 4-wire cable • Standard cable with polymer / brass / stainless steel cable glands (metric or NPT) • Armored cable with stainless steel armored cable glands (metric or NPT) • Conduit entries (metric or NPT)
Material	
Measuring tubes	<ul style="list-style-type: none"> • AISI 316L / W1.4404 • Hastelloy C22 / UNS N06022
Process connectors	<ul style="list-style-type: none"> • Standard: <ul style="list-style-type: none"> – AISI 316L / W1.4435 or W1.4404 – Hastelloy C22 / UNS N06022 • Hygienic: <ul style="list-style-type: none"> – AISI 316L / W1.4435
Sensor enclosure	AISI 304 / W1.4301
Transmitter enclosure	Aluminum with corrosion-resistant coating
Measuring tube design	<p>Split flow through 2 parallel tubes with combined cross-section area 50% of the nominal pipe</p> <p>The measuring tubes are bent in a trapezoidal curve</p>

11.9 Power supply

Description	Specification
Measuring tube surface roughness	<ul style="list-style-type: none"> Standard: 1.6 µm Hygienic: 0.8 µm
Self-draining design	Yes, when mounted vertically

*: Pressure ratings depend on sensor material

** : Pressure ratings depend on process connection dimension

11.9 Power supply

Table 11- 26 Power supply

Description	Specification
Supply Voltage [V]	24 VDC +/- 20% (DC supply)
Reverse polarity protection (Y/N)	Y

11.10 Cables and cable entries

The following information applies to cables and cable glands supplied as accessories to the device.

Table 11- 27 Power and signal cable, basic data

Description	Specification
Number of conductors	4
Square area [mm ²]	0.326 (AWG 22/7)
Screen	Yes
Outside color	Gray (RAL 7001)
External diameter [mm]	6.5
Maximum length	300 m (984 ft.)
Installation environment	Industrial including chemical processing plants
Insulation material	Special polyolefin
Halogen-free	Yes
RoHS compliant	Yes
Torsional strength	<ul style="list-style-type: none"> >3 million cycles at ± 180° on 200 mm Not adapted for garland mounting (festoon)
Permissible temperature range [°C (°F)]	-40 to +80 (-40 to +176)
Min. bending radius allowed	Single 5 X ø

Table 11- 28 Cable glands and entries

Description	Specification
Glands	<ul style="list-style-type: none"> • Material <ul style="list-style-type: none"> – Nylon¹⁾ – Brass/Ni plated – Stainless steel AISI 316/1.4404 • Cable cross section <ul style="list-style-type: none"> – Ø 5 to 10 mm (0.20" to 0.39")
Entry	<ul style="list-style-type: none"> • 1 x M20 or 1 X NPT ½" for communication

¹⁾: If operating temperature is below -20 °C (-4 °F), use Brass/Ni plated or stainless steel cable glands.

Note

For hygienic applications (3A & EHEDG) the cable glands and blind plugs must be made from corrosion resistant material like nickel brass, stainless steel or plastic. The exposed threads must be minimized when they are tightened up on the cable and they must have a seal (plastic or rubber) under the threads where they screw into the terminal housing or enclosure.

11.11 Installation torques

Table 11- 29 Installation torques

Description	Torque (Nm)
Pressure guard fittings	80
Pedestal lock screw cap	10
Cable gland to housing (Siemens supplied, metric)	10

Note

NPT glands

When using NPT glands, user must take care when packing threads and installing cables that sufficient tightness is obtained to prevent ingress of moisture.

11.12 Certificates and approvals

Table 11- 30 Certificates and approvals

Description	Specification
ATEX	FC410 flowmeter (can be installed in Zone 1 for gas and Zone 20/21 for dust): ATEX Certificate: SIRA 11ATEX1341X Ⓜ II 1/2 G II 1/2D Ex d ia IIC T* Gb Ex ta/tb IIIC T*°C Da/Db Ta = -40°C to +60°C * Temperature class (dependent on the "Maximum Process Temperature", see Special Conditions for Safe Use)
IECEX	FC410 flowmeter (can be installed in Zone 1 for gas and Zone 20/21 for dust): Certificate: IECEX SIR 11.0149X Ex d ia IIC T* Gb Ex ta IIIC T*dgC Da/Db (Ta = -40°C to +60°C) * Temperature class (dependent on the "Maximum Process Temperature", see Conditions of Certification)
FM	Class I Division 1 Groups A,B,C,D T* (XP, IS) Class II Division 1 Groups E,F,G Class III Division 1 Group H (granulates) Class I Zone 1 and Zone 20/21 *: Depends on media temperature, ambient temperature and configuration (compact or remote) (T6-T2)
Hygienic version	3A EHEDG EC1935:2004 and 2023:2006 (food contact material: stainless steel)
Pressure equipment	97/23/EC Pressure Equipment Directive (PED) Canadian Registration Number (CRN)

11.13 PED

The pressure equipment directive 97/23/EC applies to the alignment of the statutory orders of the European member states for pressure equipment. Such equipment in the sense of the directive includes vessels, pipelines and accessories with a maximum allowable pressure of more than 0.5 bar above atmospheric. Flowmeters are considered as piping.

A detailed risk analysis of the flowmeter has been performed in accordance with the PED 97/23/EC. All risks are assessed to be "none" provided that the procedures and standards referenced in these operating instructions are observed.

11.13.1 Division according to the danger potential

Flowmeters, which are categorized as piping, are divided into categories according to danger potential (medium, pressure, nominal diameter). The flowmeters fall into the categories I to III or they are manufactured according to Article 3 Paragraph 3 - Sound Engineering Practice (SEP).





The following criteria are decisive for assessment of the danger potential, and are also shown in Diagrams 6 to 9.



Fluid group	Group 1 or 2
• Aggregate state	Liquid or gaseous
• Type of pressurized equipment	
– Pipeline	Product of pressure and volume (PS * V [barL])

The maximum allowable temperature for the used liquids or gases is the maximum process temperature which can occur, as defined by the user. This must be within the limits defined for the equipment.

11.13.2 Division of media (liquid/gaseous) into the fluid groups

Table 11- 31 Fluids are divided according to Article 9 into the following fluid groups:

Group 1	
<p>Explosive R phrases: for example: 2, 3 (1, 4, 5, 6, 9, 16, 18, 19, 44)</p> 	<p>Very toxic R phrases: for example: 26, 27, 28, 39 (32)</p> 
<p>Extremely flammable R phrases: for example: 12 (17)</p> 	<p>Toxic R phrases: for example: 23, 24, 25 (29, 31)</p> 

<p>Group 1</p>	
<p>Highly flammable R phrases: for example: 11, 15, 17 (10, 30)</p> 	<p>Oxidizing R phrases: for example: 7, 8, 9 (14, 15, 19)</p> 
<p>Flammable R phrases: for example 11 (10)</p> 	
<p>Group 2</p> <p>All fluids not belonging to Group 1. Also applies to fluids which are for example dangerous to the environment, corrosive, dangerous to health, irritant or carcinogenic (if not highly toxic).</p>	

11.13.3 Conformity assessment

Flowmeters of categories I to III comply with the safety requirements of the directive. They are affixed with the CE mark and an EC declaration of conformity is provided.

The flowmeters are subjected to the conformity assessment procedure - Module H.

Flowmeters according to Article 3 Paragraph 3 are designed and manufactured in accordance with sound engineering practice in Denmark. PED conformity reference is not affixed to the CE mark.

11.13.4 Diagrams

- Gases of fluid group 1
- Pipelines according to Article 3 Number 1.3 Letter a) First dash
- Exception: unstable gases belonging to Categories I and II must be included in Category III.

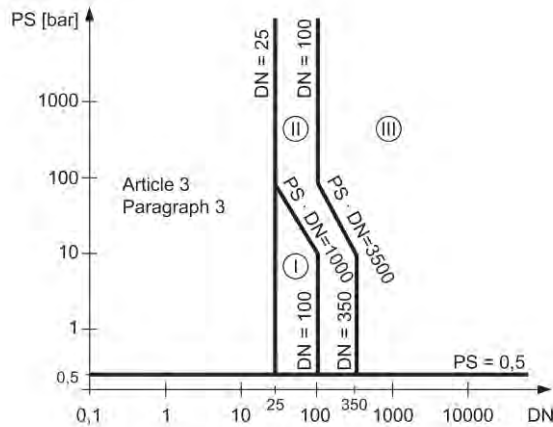

Figure 11-3 Diagram 6

- Gases of fluid group 2
- Pipelines according to Article 3 Number 1.3 Letter a) Second dash
- Exception: liquids at temperatures > 350 °C belonging to Category II must be included in Category III.

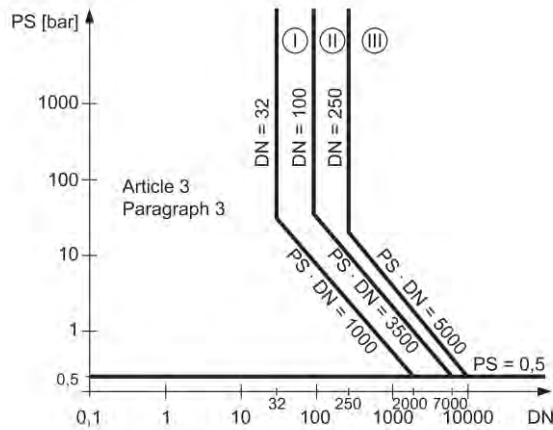

Figure 11-4 Diagram 7

- Liquids of fluid group 1
- Pipelines according to Article 3 Number 1.3 Letter b) First dash

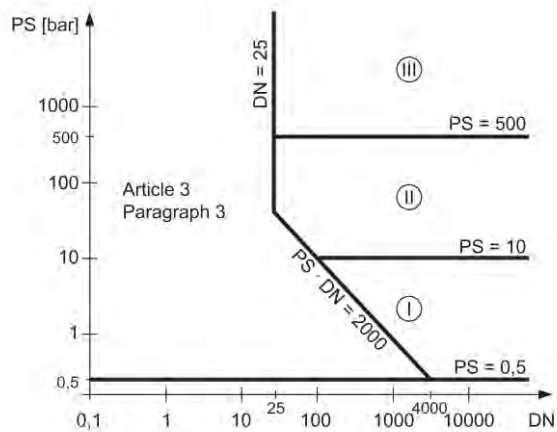

Figure 11-5 Diagram 8

- Liquids of fluid group 2
- Pipelines according to Article 3 Number 1.3 Letter b) Second dash

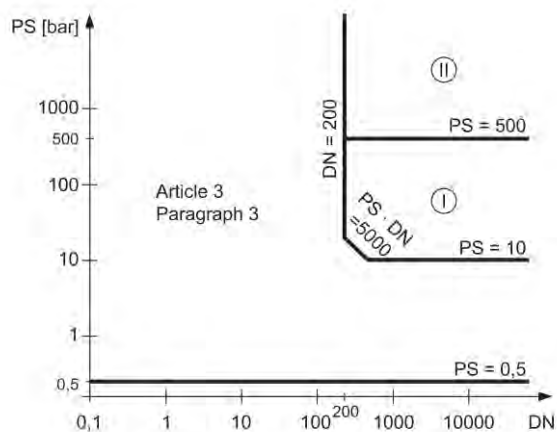



Figure 11-6 Diagram 9

Spare parts and accessories

12.1 Ordering

In order to ensure that the ordering data you are using is not outdated, the latest ordering data is always available on the Internet: Catalog process instrumentation (<http://www.siemens.com/processinstrumentation/catalogs>)





12.2 Ex approved products

 WARNING
Repair of Ex-approved products It is the customer's responsibility that repair of Ex-approved products fulfill national requirements.

12.3 Replaceable components

This table gives an overview of which components can be replaced.

Table 12- 1 Overview of replaceable components

Component	Order number	Photo and position on illustration in Design (Page 22)	Hot swappable *
SITRANS FC410 Blind lid small (Ø85 mm)	A5E03549295		Yes Observe hazardous area access protocol
SITRANS FC410 electronic	A5E03549191		No
SITRANS FC410 Housing metric	A5E03549313		No
SITRANS FCS410 Housing NPT	A5E03906080		No
SITRANS FC410 Bag of loose parts for sensor	A5E03549324	Contents: Screws, O-rings, cable clamp parts	
SITRANS FC410 M12 option for FC410 housing	A5E03906095		No

* Components may be replaced while power is on in non-hazardous locations only.

Dimensions and weight

13.1 Sensor dimensions

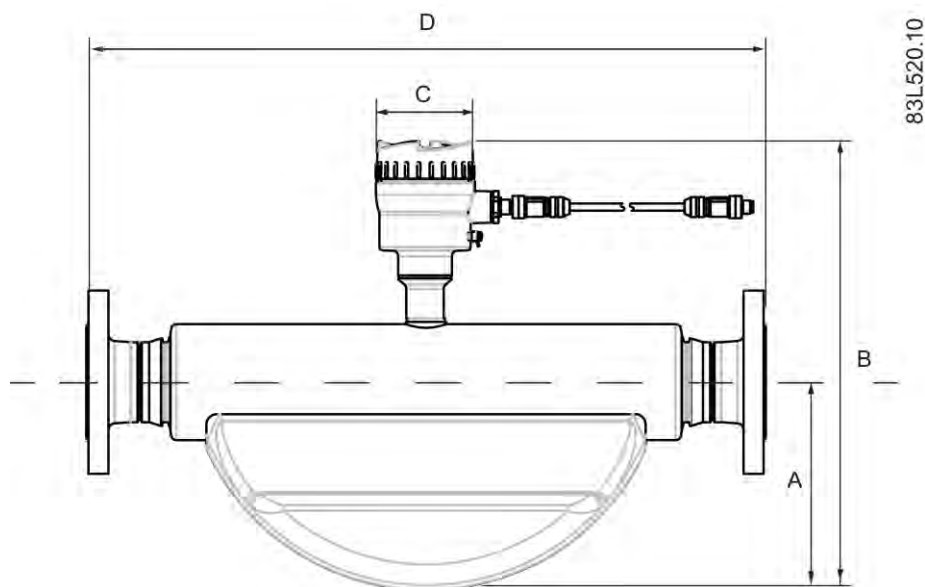

Table 13- 1 Basic dimensions

Sensor DN	A in mm (inch)	B in mm (inch)	C in mm (inch)	Weight in kg (lb)
15 (½")	90 (3.54)	280 (11.0)	90 (3.54)	4.6 (10.1)
25 (1")	123 (4.84)	315 (12.4)	90 (3.54)	7.9 (17.4)
50 (2")	187 (7.36)	390 (15.4)	90 (3.54)	25.7 (56.7)
80 (3")	294 (11.6)	504 (19.8)	90 (3.54)	66.5 (147)

Note

The build in length (D) depends on the process connector.

13.2 Length matrix

316L stainless steel or Hastelloy - standard

Table 13- 2 7ME461 - sensor sizes DN15 and DN25

Sensor	DN15					DN25		
	DN6	DN10	DN15	DN20	DN25	DN25	DN32	DN40
EN1092-1 B1, PN16			265 (10.4)		265 (10.4)	360 (14.2)		365 (14.4)
EN1092-1 B1, PN40			265 (10.4)		265 (10.4)	360 (14.2)		365 (14.4)
EN1092-1 B1, PN63			265 (10.4)			360 (14.2)		
EN1092-1 B1, PN100			270 (10.6)		275 (10.8)	360 (14.2)		365 (14.4)
EN1092-1 B1, PN160			270 (10.6)			360 (14.2)		
EN1092-1 D, PN40			265 (10.4)			360 (14.2)		
EN1092-1 D, PN63			265 (10.4)			360 (14.2)		
EN1092-1 D, PN100			270 (10.6)			360 (14.2)		
EN1092-1 D, PN160			270 (10.6)			360 (14.2)		
ANSI B16.5, Class 150			270 (10.6)	270 (10.6)		360 (14.2)		365 (14.4)
ANSI B16.5, Class 300			270 (10.6)	270 (10.6)		360 (14.2)		380 (15.0)
ANSI B16.5, Class 600			270 (10.6)	285 (11.2)		360 (14.2)		380 (15.0)
ANSI B16.5, Class 900			290 (11.4)			385 (15.2)		
ISO 228-1 G Pipe thread	265 (10.4)		265 (10.4)			365 (14.4)		
ANSI B1.20.1 NPT Pipe thread	265 (10.4)		270 (10.6)			365 (14.4)		
DIN 11851 Hygienic screwed		265 (10.4)	265 (10.4)		270 (10.6)	360 (14.2)	360 (14.2)	
DIN 32676-C Hygienic clamp			265 (10.4)	265 (10.4)		360 (14.2)		360 (14.2)
DIN 11864-1 Aseptic screwed			265 (10.4)			360 (14.2)		
DIN 11864-2A Aseptic flanged			265 (10.4)			360 (14.2)		
DIN 11864-3A Aseptic clamp			265 (10.4)			360 (14.2)		

ISO 2852 Hygienic clamp					265 (10.4)	360 (14.2)		360 (14.2)
ISO 2853 Hygienic screwed					265 (10.4)	360 (14.2)		360 (14.2)
SMS 1145 Hygienic screwed					265 (10.4)	360 (14.2)		
12-VCO-4 Quick connect			285 (11.2)					
JIS B2220 10K			265 (10.4)			360 (14.2)		
JIS B2220 20K			265 (10.4)			360 (14.2)		
JIS B2220 40K			270 (10.6)			360 (14.2)		
JIS B2220 63K			275 (10.8)			370 (14.6)		

Dimensions in mm (inch)

Table 13- 3 7ME461 - sensor sizes DN50 and DN80

Sensor	DN50		DN80		
	DN40	DN50	DN65	DN80	DN100
EN1092-1 B1, PN16	610 (24.0)	610 (24.0)	915 (36.0)	840 (33.1)	840 (33.1)
EN1092-1 B1, PN40	610 (24.0)	610 (24.0)	915 (36.0)	840 (33.1)	840 (33.1)
EN1092-1 B1, PN63	610 (24.0)	610 (24.0)	915 (36.0)	915 (36.0)	915 (36.0)
EN1092-1 B1, PN100	610 (24.0)	610 (24.0)	915 (36.0)	915 (36.0)	915 (36.0)
EN1092-1 B1, PN160		620 (24.4)		915 (36.0)	
EN1092-1 D, PN40	610 (24.0)	610 (24.0)		840 (33.1)	
EN1092-1 D, PN63	610 (24.0)	610 (24.0)		915 (36.0)	
EN1092-1 D, PN100	610 (24.0)	610 (24.0)		915 (36.0)	
EN1092-1 D, PN160		620 (24.4)		915 (36.0)	
ANSI B16.5, Class 150		620 (24.4)	915 (36.0)	875 (34.4)	
ANSI B16.5, Class 300		620 (24.4)	915 (36.0)	875 (34.4)	
ANSI B16.5, Class 600		620 (24.4)	915 (36.0)	875 (34.4)	
ANSI B16.5, Class 900		620 (24.4)		875 (34.4)	
ISO 228-1 G Pipe thread		620 (24.4)			
ANSI B1.20.1 NPT pipe thread		620 (24.4)			
DIN 11851 Hygienic screwed	610 (24.0)	610 (24.0)	840 (33.1)	840 (33.1)	
DIN 32676-C Hygienic clamp		610 (24.0)		875 (34.4)	
DIN 11864-1 Aseptic screwed	610 (24.0)	610 (24.0)		875 (34.4)	
DIN 11864-2A Aseptic flanged	620 (24.4)	610 (24.0)		875 (34.4)	
DIN 11864-3A Aseptic clamp	610 (24.0)	610 (24.0)		840 (33.1)	
ISO 2852 Hygienic clamp	610 (24.0)	610 (24.0)		840 (33.1)	
ISO 2853 Hygienic screwed	630 (24.8)	610 (24.0)		860 (33.9)	

Dimensions and weight

13.3 316L stainless steel - NAMUR

SMS 1145 Hygienic screwed	610 (24.0)	610 (24.0)		875 (34.4)	
12-VCO-4 Quick connect					
JIS B2220 10K	620 (24.4)	610 (24.0)		840 (33.1)	
JIS B2220 20K	620 (24.4)	610 (24.0)		860 (33.9)	
JIS B2220 40K	620 (24.4)	610 (24.0)		875 (34.4)	
JIS B2220 63K		620 (24.4)		875 (34.4)	

Dimensions in mm (inch)

13.3 316L stainless steel - NAMUR

316L stainless steel - NAMUR

Table 13- 4 7ME471 - sensor sizes DN15 and DN25

Sensor	DN15					DN25		
	DN6	DN10	DN15	DN20	DN25	DN25	DN32	DN40
EN1092-1 B1, PN16			510 (20.1)		510 (20.1)	600 (23.6)		605 (23.8)
EN1092-1 B1, PN40			510 (20.1)		510 (20.1)	600 (23.6)		605 (23.8)
EN1092-1 B1, PN63			510 (20.1)			600 (23.6)		
EN1092-1 B1, PN100			515 (20.3)		520 (20.5)	600 (23.6)		605 (23.8)
EN1092-1 B1, PN160			515 (20.3)			600 (23.6)		
EN1092-1 D, PN40			510 (20.1)			600 (23.6)		
EN1092-1 D, PN63			510 (20.1)			600 (23.6)		
EN1092-1 D, PN100			515 (20.3)			600 (23.6)		
EN1092-1 D, PN160			515 (20.3)			600 (23.6)		
ANSI B16.5, Class 150			515 (20.3)	515 (20.3)		600 (23.6)		605 (23.8)
ANSI B16.5, Class 300			515 (20.3)	515 (20.3)		600 (23.6)		620 (24.4)
ANSI B16.5, Class 600			515 (20.3)	530 (20.9)		600 (23.6)		620 (24.4)
ANSI B16.5, Class 900			535 (21.1)			625 (24.6)		
ISO228-1 G Pipe thread	510 (20.1)		510 (20.1)			605 (23.8)		

ANSI B1.20.1 NPT Pipe thread	510 (20.1)		515 (20.3)			605 (23.8)		
DIN 11851 Hygienic screwed		510 (20.1)	510 (20.1)		515 (20.3)	600 (23.6)	600 (23.6)	
DIN 32676-C Hygienic clamp			510 (20.1)	510 (20.1)		600 (23.6)		600 (23.6)
DIN 11864-1 Aseptic screwed			510 (20.1)			600 (23.6)		
DIN 11864-2A Aseptic flanged			510 (20.1)			600 (23.6)		
DIN 11864-3A Aseptic clamp			510 (20.1)			600 (23.6)		
ISO 2852 Hygienic clamp					510 (20.1)	600 (23.6)		600 (23.6)
ISO 2853 Hygienic screwed					510 (20.1)	600 (23.6)		600 (23.6)

Dimensions in mm (inch)

Table 13- 5 7ME471 - sensor sizes DN50 and DN80

Sensor	DN50		DN80		
	DN40	DN50	DN65	DN80	DN100
EN1092-1 B1, PN16	715 (28.1)	715 (28.12)	915 (36.0)	915 (36.0)	915 (36.0)
EN1092-1 B1, PN40	715 (28.1)	715 (28.1)	915 (36.0)	915 (36.0)	915 (36.0)
EN1092-1 B1, PN63	715 (28.1)	715 (28.1)	915 (36.0)	915 (36.0)	915 (36.0)
EN1092-1 B1, PN100	715 (28.1)	715 (28.1)	915 (36.0)	915 (36.0)	915 (36.0)
EN1092-1 B1, PN160		725 (28.5)		915 (36.0)	
EN1092-1 D, PN40	715 (28.1)	715 (28.1)		915 (36.0)	
EN1092-1 D, PN63	715 (28.1)	715 (28.1)		915 (36.0)	
EN1092-1 D, PN100	715 (28.1)	715 (28.1)		915 (36.0)	
EN1092-1 D, PN160		725 (28.5)		915 (36.0)	
ANSI B16.5-2009, Class 150		725 (28.5)	915 (36.0)	950 (37.4)	
ANSI B16.5-2009, Class 300		725 (28.5)	915 (36.0)	950 (37.4)	
ANSI B16.5-2009, Class 600		725 (28.5)	915 (36.0)	950 (37.4)	
ANSI B16.5-2009, Class 900		725 (28.5)		950 (37.4)	
ISO228-1 G pipe thread		725 (28.5)			
ANSI B1.20.1 NPT pipe thread		725 (28.5)			
DIN 11851 Hygienic screwed	715 (28.1)	715 (28.1)	915 (36.0)	915 (36.0)	
DIN 32676-C Hygienic clamp		715 (28.1)		950 (37.4)	
DIN 11864-1 Aseptic screwed	715 (28.1)	715 (28.1)		950 (37.4)	
DIN 11864-2A Aseptic flanged	725 (28.5)	715 (28.1)		950 (37.4)	
DIN 11864-3A Aseptic clamp	715 (28.1)	715 (28.1)		915 (36.0)	
ISO 2852 Hygienic clamp	715 (28.1)	715 (28.1)		915 (36.0)	
ISO 2853 Hygienic screwed	735 (28.9)	715 (28.1)		860 (33.9)	

Dimensions in mm (inch)

13.4 Hygienic versions

316L stainless steel - hygienic version

Table 13- 6 7ME462 - sensor sizes DN15 and DN25

Sensor	DN15					DN25		
	DN6	DN10	DN15	DN20	DN25	DN25	DN32	DN40
DIN 11851 Hygienic screwed		265 (10.4)	265 (10.4)		270 (10.6)	360 (14.2)	360 (14.2)	
DIN 32676-C Hygienic clamp			265 (10.4)	265 (10.4)		360 (14.2)		360 (14.2)
DIN 11864-1 Aseptic screwed			265 (10.4)			360 (14.2)		
DIN 11864-2A Aseptic flanged			265 (10.4)			360 (14.2)		
DIN 11864-3A Aseptic clamp			265 (10.4)			360 (14.2)		
ISO 2852 Hygienic clamp					265 (10.4)	360 (14.2)		360 (14.2)
ISO 2853 Hygienic screwed					265 (10.4)	360 (14.2)		360 (14.2)
SMS 1145 Hygienic screwed					265 (10.4)	360 (14.2)		

Dimensions in mm (inch)

Table 13- 7 7ME462 - sensor sizes DN50 and DN80

Sensor	DN50			DN80	
	DN40	DN50	DN65	DN80	
DIN 11851 Hygienic screwed	610 (24.0)	610 (24.0)	840 (33.1)	840 (33.1)	
DIN 32676-C Hygienic clamp		610 (24.0)		875 (34.4)	
DIN 11864-1 Aseptic screwed	610 (24.0)	610 (24.0)		875 (34.4)	
DIN 11864-2A Aseptic flanged	620 (24.4)	610 (24.0)		875 (34.4)	
DIN 11864-3A Aseptic clamp	610 (24.0)	610 (24.0)		840 (33.1)	
ISO 2852 Hygienic clamp	610 (24.0)	610 (24.0)		840 (33.1)	
ISO 2853 Hygienic screwed	630 (24.8)	610 (24.0)		860 (33.9)	
SMS 1145 Hygienic screwed	610 (24.0)	610 (24.0)		875 (34.4)	

Dimensions in mm (inch)

Note

3A

DIN 11851 and ISO 2853 are only 3A-approved if self-centring gaskets are used.

Modbus holding registers

A.1 Modbus addressing model

The device allows read/write access to the following standard Modbus RTU data holding register blocks:

- Holding registers (ref. 4x address range)

The minimum value of a writable "**holding register**" can be read by adding 10000 to the Modbus address of the register.

The maximum value of a writable "**holding register**" can be read by adding 20000 to the Modbus address of the register.

The default value of a writable "**holding register**" can be read by adding 30000 to the Modbus address of the register.

A.2 Modbus function codes

This device supports following function codes: 3, 8 and 16.

Function codes 3 and 16 are used for accessing registers, max. 16 registers per read/write request is accepted.

Function code 8 is used for reading Modbus communication diagnostic information.

Below the various function code are described.

Function code 3 (Read holding registers)

General exceptions:

- Requesting less than 1 or more than 16 registers => Exception 3 (Illegal data value)
- Requesting invalid start address or start address with invalid quantity => Exception 2 (Illegal data address)

Application exceptions:

- Application errors; min/max limit of parameter exceeded; or parameter write-protected => Exception 4 (Slave device error)

Holes/register alignment:

- The read command always returns data if no exception is given.
- Holes in the holding register map return value zero in all bytes. E.g. reading 2 registers starting at 4:0004 above will result in 2 bytes of "float B" followed by 2 zeroes.

Function code 3 example

Query

Slave address	1 byte
Function	1 byte
Starting Address Hi	1 byte
Starting Address Lo	1 byte
Quantity of Registers Hi	1 byte
Quantity of Registers Lo	1 byte
CRC	2 bytes

Response

Slave address	1 byte
Function	1 byte
Byte count	1 byte
Register Value Hi	1 byte
Register Value Lo	1 byte
:	:
Register Value Hi	1 byte
Register Value Lo	1 byte
CRC	2 bytes

Example: Read absolute massflow (address 3000)

Query: 1,3,11,184,0,2,70,10

Slave address = 1 (0x01)
 Function = 3 (0x03)
 Starting Address Hi, Lo = 11, 184 (0x0B,0xB8)
 Quantity of Registers Hi, Lo = 0, 2 (0x00,0x02)
 CRC = 70,10 (0x46, 0x0A)

Starting address 0x0BB8 = 3000
 Quantity of registers = 0x0002 = 2

Response: 1,3,4,64,195,82,139,98,200

Slave address = 1 (0x01)
 Function = 3 (0x03)
 Byte Count = 4 (0x04)
 Register 1 - Register Value Hi, Lo = 64, 195 (0x40, 0xC3)
 Register 2 - Register Value Hi, Lo = 82, 139 (0x52, 0x93)
 CRC = 98,200 (0x62, 0xC8)

Absolute mass flow = 0x40C35293 = 6.10383 kg/sec

Function code 16 (Write multiple registers)

General exceptions

- Writing less than 1 or more than 16 registers => Exception 3 (Illegal data value)
- If ByteCount is not exactly 2 times NoOfRegisters => Exception 3 (Illegal data value)
- Requesting invalid start address or start address with invalid quantity => Exception 2 (Illegal data address)

Application exceptions:

- Application errors; min/max limit of parameter exceeded; or parameter write-protected => Exception 4 (Slave device error)
- Application errors include writing to ReadOnly holding registers

Holes/register alignment:

- If start-address is not the start of a mapped holding register => Exception 2 (Illegal data address)
- Writing to holes is allowed (ie ignored - and no exception occurs) - except for the condition described above
- If the end address is only part of a mapped holding register item (e.g. one half of a float value), the action depends on the data type. Writing parts of all data types => Exception 4 (Slave device error)

Function code 16 example

Query

Slave address	1 byte
Function	1 byte
Starting Address Hi	1 byte
Starting Address Lo	1 byte
Quantity of Registers Hi	1 byte
Quantity of Registers Lo	1 byte
Byte Count	1 byte
Registers Value Hi	1 byte
Registers Value Lo	1 byte
:	:
Registers Value Hi	1 byte
Registers Value Lo	1 byte
CRC	2 bytes

Response

Slave address	1 byte
Function	1 byte
Starting Address Hi	1 byte
Starting Address Lo	1 byte
Quantity of Registers Hi	1 byte
Quantity of Registers Lo	1 byte
CRC	2 bytes

Example: Set baud rate to 115200 baud (address 529)

Query: 1,16,2,17,0,1,2,0,5,70,210

Slave address = 1 (0x01)
 Function = 16 (0x10)
 Starting Address Hi, Lo = 2, 17 (0x02,0x11)
 Quantity of Registers Hi, Lo = 0, 1 (0x00,0x01)
 Byte Count = 2 (0x02)
 Registers Value Hi, Lo = 0, 5 (0x00,0x05)
 CRC = 70,10 (0x46, 0x0A)

Starting address 0x0211 = 529
 Number of registers = 0x0001 = 1
 Data 0x0005 = (115200 = value 5)

Response: 1,16,2,17,0,1,80,116

Slave address = 1 (0x01)
 Function = 16 (0x10)
 Starting Address Hi, Lo = 2, 17 (0x02,0x11)
 Quantity of Registers Hi, Lo = 0, 1 (0x00,0x01)
 CRC = 80,116 (0x50, 0x74)

Function code 8 (Diagnostics)

Modbus function code 8 provides a series of tests for checking the communication system between a client (Master) device and a server (Slave).

The following diagnostics functions are supported:

Sub-function code (Dec)	Name	Description
00	Return Query Data	The data passed in the request data field is to be returned (looped back) in the response.
10	Clear Counters and Diagnostic Register	Clears all counters and the diagnostic register. Counters are also cleared upon power-up.
11	Return Bus Message Count	The response data field returns the quantity of messages that the remote device has detected on the communications system since its last restart, clear counters execution, or power-up.

Sub-function code (Dec)	Name	Description
12	Return Bus Communication Error Count	The response data field returns the quantity of CRC errors encountered by the remote device since its last restart, clear counters execution, or power-up.
13	Return Bus Exception Error Count	The response data field returns the quantity of MODBUS exception responses returned by the remote device since its last restart, clear counters execution, or power-up.
14	Return Slave Message Count	The response data field returns the quantity of messages broadcast or addressed to the remote device that the remote device has processed since its last restart, clear counters execution, or power-up.
15	Return Slave No Response Count	The response data field returns the quantity of messages addressed to the remote device for which it has returned no response (neither a normal response nor an exception response), since its last restart, clear counters execution, or power-up.
16	Return Slave NAK Count	The response data field returns the quantity of messages addressed to the remote device for which it returned a Negative Acknowledge (NAK) exception response, since its last restart, clear counters execution, or power-up.
17	Return Slave Busy Count	The response data field returns the quantity of messages addressed to the remote device for which it returned a Slave Device Busy exception response, since its last restart, clear counters execution, or power-up.
18	Return Bus Character Overrun Count	The response data field returns the quantity of messages addressed to the remote device that it could not handle due to a character overrun condition, since its last restart, clear counters execution, or power-up.
20	Clear Overrun Counter and Flag	Clears the overrun error counter and resets the error flag.

Function code 8 example

Query

Slave address	1 byte
Function	1 byte
Sub-function Hi	1 byte
Sub-function Lo	1 byte
Data Hi	1 byte
Data Lo	1 byte
:	:
Data Hi	1 byte
Data Lo	1 byte
CRC	2 bytes

Response

Slave address	1 byte
Function	1 byte
Sub-function Hi	1 byte
Sub-function Lo	1 byte
Data Hi	1 byte
Data Lo	1 byte
:	:
Data Hi	1 byte
Data Lo	1 byte
CRC	2 bytes

Example: Read Return Slave Message Count (address 529)

Query: 1,8,0,14,0,0,129,200

Slave address = 1 (0x01)
Function = 8 (0x08)
Sub-function Hi, Lo = 0, 14 (0x00,0x0E)
Data Hi, Lo = 0, 0 (0x00,0x00)
CRC = 129,200 (0x81, 0xC8)

Sub-function 0x000E = 14 = Read Return Slave Message Count

Response: 1,8,0,14,0,97,64,32

Slave address = 1 (0x01)
Function = 8 (0x08)
Sub-function Hi, Lo = 0, 14 (0x00,0x0E)
Data Hi, Lo = 0, 97 (0x00,0x65)
CRC = 64,32 (0x41, 0xE3)

Read Return Slave Message Count = 0x0065 = 97 message received

A.3 Modbus holding registers tables

In the following the Modbus RTU holding registers available for FC410 are described.

Note

All Write parameters require password access.

A.3.1 Process values

Table A- 1 Process values

Modbus address	Data type / Size [bytes]	Parameter	Description	Default value [unit]	Value range	Access level
247 / 2007 / 3000	float / 4	Massflow	Measured massflow	- [kg/s]	-	Read Only
253 / 2009 / 3002	float / 4	Volumeflow	Measured volumeflow	- [m ³ /s]	-	Read Only
249 / 2013 / 3004	float / 4	Density	Measured density	- [kg/m ³]	-	Read Only
251 / 2017 / 3010	float / 4	Temperature	Measured temperature of the process media	- [°C]	-	Read Only
3023	float / 4	Frame Temperature	Measured temperature of the sensor frame	- [°C]	-	Read Only

A.3.2 Identification

Table A- 2 FC410

Modbus address	Data type / Size (bytes)	Parameter	Description	Default value (unit)	Value range	Access level
4000	String / 20	Manufacturer	Device manufacturer	Siemens	-	Read Only
4020	String / 10	Sensor Firmware Revision	Sensor firmware version	-	-	Read Only
4025	String / 16	SensorType	Sensor type. Also shown on the device nameplate	SITRANS FCS400	-	Read Only
4033	String / 20	Sensor Serial Number	Unique sensor serial number. Also shown on the device nameplate	-	-	Read Only
4095	String / 10	Sensor Hardware Revision	Sensor hardware version	-	-	Read Only
4100	String / 10	Sensor Frontend Type	Sensor hardware variant	-	-	Read Only
4121	String / 20	Sensor Order Number	Sensor order number part 1 (MLFB). Also shown on the device nameplate	-	-	Read Only
4131	String / 32	Sensor Order Number	Sensor order number part 2 (MLFB). Also shown on the device nameplate	-	-	Read Only

Modbus holding registers

A.3 Modbus holding registers tables

Modbus address	Data type / Size (bytes)	Parameter	Description	Default value (unit)	Value range	Access level
4147	String / 32	Sensor Order Number	Sensor order number part 3 (MLFB). Also shown on the device nameplate	-	-	Read Only
4164	String / 32	Long TAG	Enter a unique TAG name for the device (up to 32 characters)			
4180	String / 16	Descriptor	Enter a unique description for the measurement point (up to 16 characters)			
4188	String / 16	Startup Date	Enter the installation date of the device			

A.3.3 Setup

Table A- 3 Operating conditions

Modbus address	Data type / Size [bytes]	Parameter	Description	Default value [unit]	Value range	Access level
2100	Unsigned / 2	Flow Direction	<p>Define positive and negative flow direction.</p> <p>Default positive flow direction is indicated by the arrow on the sensor.</p> <p>Possible selections:</p> <ul style="list-style-type: none"> • 0: Negative: The flow is measured '+' in default negative direction and '-' in default positive direction. • 1: Positive: The flow is measured '+' in default positive direction and '-' in default negative direction 	1	<ul style="list-style-type: none"> • 0 • 1 	Read / Write
2130	Unsigned / 2	Process Noise Damping	<p>Select process noise damping level:</p> <p>0: 55 ms filtering (Centrifugal Pump)</p> <p>1: 110 ms filtering (Triplex Pump)</p> <p>2: 220 ms filtering (Duplex Pump)</p> <p>3: 400 ms filtering (Simplex Pump)</p> <p>4: 800 ms filtering (Cam Pump)</p>	2	<ul style="list-style-type: none"> • 0: Low • 1 • 2 • 3 • 4: High 	Read / Write

A.3 Modbus holding registers tables

Table A- 4 Massflow

Modbus address	Data type / Size [bytes]	Parameter	Description	Default value [unit]	Value range	Access level
2125	Float / 4	Low Massflow Cut-Off	Set massflow limit for low flow cut-off. Below this limit massflow output is forced to zero. If Low Flow Cut-Off is set to 0, the cut-off functionality is disabled. Notice: It is recommended to set a lower value for gas applications.	Sensor size specific [kg/s] ¹⁾	0 to 1023	Read / Write
2426	Float / 4	Massflow Correction Factor	Specify correction factor for use in the massflow calculation	1	-1.999 to +1.999	Read / Write

¹⁾: See Sensor dimension dependent default settings (Page 143)

Table A- 5 Volume flow

Modbus address	Data type / Size [bytes]	Parameter	Description	Default value [unit]	Value range	Access level
2170	Float / 4	Low Volumeflow Cut Off	Define the numerical volumeflow value below which the volume flow output is forced to zero.	Sensor size specific [m ³ /s] ¹⁾	0 to 0.177	Read / Write

¹⁾: See Sensor dimension dependent default settings (Page 143)

Table A- 6 Density

Mdbus address	Data type / Size [bytes]	Parameter	Description	Default value [unit]	Value range	Access level
2127	Float / 4	Empty Tube Limit	Define threshold value of empty tube	500 [kg/m ³]	-14 000 to +14 000	Read / Write
2129	Unsigned / 2	Empty Tube Detection	Set automatic detection of Empty Tube On/Off 0 = off (Empty tube is off). 1 = on (a density value below Empty Tube Limit triggers an alarm. All flow rate values are forced to zero %).	0	<ul style="list-style-type: none"> • 0 • 1 	Read / Write

Mdbus address	Data type / Size [bytes]	Parameter	Description	Default value [unit]	Value range	Access level
2442	Float / 4	Density Correction Factor	Set density compensation value (gain) in order to make a density correction (scale factor). To increase the displayed density value with +0.5 %, set the density factor to 1.005. The displayed density value will now be 0.5 % higher than before	1	-1.999 to +1.999	Read / Write
2444	Float / 4	Density Correction Offset	Set density compensation value (offset) in order to make an offset on the measured density. To make the flowmeter show + 2 kg/m ³ , change the density offset to 2.000 kg/m ³ in the 'Sensor' menu	0 [kg/m ³]	-1 400 to +1 400	Read / Write

A.3.4 Totalizer

Table A- 7 Totalizer

Modbus address	Data type / Size [bytes]	Parameter	Description	Default value [unit]	Value range	Access level
2609	unsigned / 2	Totalizer State	Totalizer state <ul style="list-style-type: none"> 0 = paused 1 = running 	1	<ul style="list-style-type: none"> 0 1 	Read only
2610	float / 4	Totalizer Value	The totalized MASS value in kg	0 [kg/s]	Min. - 1.70E+38 Max. 1.70E+38	Read Only
2612	unsigned / 2	Reset totalizer	Reset totalizer Value	-	Enter "1" to reset	Read / Write
2613	unsigned / 2	Pause totalizer	Pause totalizer Totalizer can only be paused when running	-	Enter "1" to pause	Read / Write
2614	unsigned / 2	Resume totalizer	Resume totalizer Totalizer can only be resumed when paused	-	Enter "1" to pause	Read / Write

A.3.5 Maintenance & Diagnostics

Table A- 8 Access level

Modbus address	Data type / Size [bytes]	Parameter	Description	Default value [unit]	Value range	Access level
404	Unsigned / 4	Access level	Access level to enable writing commands	-	32 (logged in) 4 (logged out)	Read / Write

Table A- 9 Maintenance

Modbus address	Data type / Size [bytes]	Parameter	Description	Default value [unit]	Value range	Access level
700	Unsigned / 2	Set To Default	Reset all parameters to factory settings	-	Enter "1" to reset	Write
2700	Unsigned / 4	Operating Time Total	Total operating time since first power up	0 [h]	-	Read Only
2702	Unsigned / 4	Operating Time	Operating time since last power up	0 [h]	-	Read Only
4088	String / 14	Firmware Time Stamp	Firmware time stamp specifies the date and time when the sensor firmware was built	-	-	Read Only
4105	String / 32	Sensor PCBA Serial Number	Serial number of the sensor electronic	-	-	Read only

Table A- 10 Device diagnostics

Modbus address	Data type / Size [bytes]	Parameter	Description	Default value [unit]	Value range	Access level
2756	Float / 4	Driver Current	Actual sensor driver current. The actual driver current is viscosity and sensor size dependent	- [A]	0 to 0.124	Read Only
2758	Float / 4	Pick-up Amplitude 1	Actual pick-up 1 amplitude	- [V]	0 to 0 9999	Read Only
2760	Float / 4	Pick-up Amplitude 2	Actual pick-up 2 amplitude	- [V]	0 to 0 9999	Read Only
2762	Float / 4	Sensor Frequency	Actual sensor frequency	- [Hz]	0 to 1 023	Read Only
3032	Float / 4	PCB Temperature	Actual sensor electronic temperature	- [C°]	-50 to 200	Read Only

Table A- 11 Aerated flow

Modbus address	Data type / Size [bytes]	Parameter	Description	Default value [unit]	Value range	Access level
2200	Unsigned / 2	Aerated Flow Alarm Limit	Alarm limit calculated in per cent of accepted bad measurements.	80 [%]	0 to 99	Read / Write
2201	Unsigned / 2	Aerated Flow Warning Limit	Warning limit calculated in per cent of accepted bad measurements	0 [%]	0 to 99	Read / Write
2202	Unsigned / 2	Measurement Sample Time	The time period over which the actual percentage of bad measurements is calculated	5 [s]	1 to 10	Read / Write
2203	Unsigned / 2	Aerated Flow Filter	Aerated flow filter 0: Disabled 1: Enabled 2: Auto Auto means that filtering starts automatically when aerated flow is measured.	2	<ul style="list-style-type: none"> • 0 • 1 • 2 	Read / Write
2204	Unsigned / 2	Filter Time Constant	PV Filter Time Constant 0 = 0 seconds 1 = 1 second 2 = 2 seconds 3 = 5 seconds 4 = 10 second	4	<ul style="list-style-type: none"> • 0 • 1 • 2 • 3 • 4 	Read / Write
2205	Float / 4	Filter Start Hysteresis	The filter is active when the hysteresis value is exceeded.	0.015 [V]	0 to 0.124	Read / Write
2207	Unsigned / 2	Minimum Filtering Time	The filtering time is reset each time hysteresis band is exceeded	100 [ms cycles]	0 to 65535	Read / Write
2214	Unsigned / 2	Pickup Amplitude Filter	Enable/disable pickup amplitude filter. 0 = Disable 1 = Enable	1	<ul style="list-style-type: none"> • 0 • 1 	Read / Write

A.3 Modbus holding registers tables

Table A- 12 Zero point adjustment

Modbus address	Data type / Size [bytes]	Parameter	Description	Default value [unit]	Value range	Access level
2132	Unsigned / 2	Zero Point Adjustment	Select zero-point adjustment method. Automatic zero point adjustment is recommended. <ul style="list-style-type: none"> • 0 = Auto • 1 = Manual 	0	<ul style="list-style-type: none"> • 0 • 1 	Read / Write
2133	Float / 4	Manual Zero Point Offset	Enter agreed zero point offset value for manual zero point adjustment mode.	0 [kg/s]	0 to 1023	Read / Write
2135	Unsigned / 2	Zero Point Duration	Define duration of zero point adjustment.	30 [s]	1 to 999	Read / Write
2136	Float / 4	Standard Deviation	Standard deviation during auto zero point adjustment	0 [kg/s]	-1023 to +1023	Read only
2138	Float / 4	Standard Deviation Limit	Set limit for zero point adjustment "Standard Deviation" value. If the "Standard Deviation" exceeds the "Standard Deviation" limit, the auto zero point adjustment is aborted.	Sensor size specific [kg/s] 1)	0 to +1023	Read / Write
2140	Float / 4	Zero Point Offset Limit	Set limit for zero point offset. If the zero point offset exceeds the zero point offset limit, the zero point offset cannot be stored	Sensor size specific [kg/s] 1)	-1023 to +1023	Read / Write
2142	Float / 4	Zero Point Offset Value	Default zero point offset based on factory calibration of sensor. A Zero point offset compensates for sensor variations due to process conditions.	0 [kg/s]	-1023 to +1023	Read only
2144	Unsigned / 2	Zero Point Adjust Progress	Shows the progress of the currently running Zero Point adjustment in percentage	0 [%]	0 to 100	Read Only

Modbus address	Data type / Size [bytes]	Parameter	Description	Default value [unit]	Value range	Access level
2145	Unsigned / 2	Zero Point Adjust Status	<p>Status of the last zero point adjustment performed Every high bit ('1') represents an error occurred in the last zero point adjustment performed.</p> <p>No high bits equals ok. Bit 1 = Zero sigma limit exceeded Bit 2 = Zero offset limit exceeded Bit 4 = Quality of zero point conditions</p>	-	<ul style="list-style-type: none"> • Bit 1 • Bit 2 • Bit 4 	Read Only
2180	Unsigned / 2	Start Zero Point Adjustment	<p>Start automatic zero point adjustment.</p> <p>The automatic zero point adjustment determines the application specific zero point offset automatically.</p> <p>Possible selections:</p> <ul style="list-style-type: none"> • 0: Idle • 1: Running • 2: Start 	0	<ul style="list-style-type: none"> • 0 • 1 • 2 	Read / Write

¹⁾: See Sensor dimension dependent default settings (Page 143)

A.3.6 Communication

Table A- 13 Modbus

Modbus address	Data type / Size [bytes]	Parameter	Description	Default value [unit]	Value range	Access level
527	Unsigned / 2	Float byte order	<p>The float byte order used in Modbus messages.</p> <p>Selection 0: Byte order: 1-0-3-2 Selection 1: Byte order: 0-1-2-3 Selection 2: Byte order: 2-3-0-1 Selection 3: Byte order: 3-2-1-0</p> <p>The first mentioned byte is the first byte sent. Byte 3 corresponds to the left-most byte (MSB) of a 32 bit float in big endian format, byte 0 corresponds to the right-most byte (LSB).</p>	3	<ul style="list-style-type: none"> • 0 • 1 • 2 • 3 	Read / Write
528	Unsigned / 2	Modbus Address	Set Modbus Device Address	1	1 to 247	Read / Write
529	Unsigned / 2	Baudrate	<p>Set communication baudrate.</p> <p>Following baud rates are available:</p> <ul style="list-style-type: none"> • 0 = 9 600 • 1 = 19 200 (Default) • 2 = 38 400 • 3 = 57 600 • 4 = 76 800 • 5 = 115 200 	1	<ul style="list-style-type: none"> • 0 • 1 • 2 • 3 • 4 • 5 	Read / Write

Modbus address	Data type / Size [bytes]	Parameter	Description	Default value [unit]	Value range	Access level
530	Unsigned / 2	Modbus Parity Framing	RS 485 parity and framing 8 databits are always used 0 = even parity, 1 stopbit 1 = odd parity, 1 stopbit 2 = no parity, 2 stopbits	0	0 to 2	Read / Write
600	Unsigned / 2	Restart communication	Restart Modbus communication Write: <ul style="list-style-type: none"> • 0 = No effect • 1 = Restart Read: <ul style="list-style-type: none"> • Always 0 	-	<ul style="list-style-type: none"> • 0 • 1 	Write

A.3.7 Characteristics

Table A- 14 Sensor

Modbus address	Data type / Size [bytes]	Parameter	Description	Default value [unit]	Value range	Access level
2113	Float / 4	Minimum Frame Temperature	Lower limit of the frame temperature	-50 [°C]		Read only
2115	Float / 4	Maximum Frame Temperature	Lower limit of the frame temperature	200 [°C]		Read only
4043	String / 16	Sensor size	Nominal sensor diameter (DN)	-	-	Read only
4053	String / 16	Hazardous area approval	Hazardous area approval of the sensor	-	-	Read only
4078	String / 16	Wetted materials	Sensor enclosure material	-	-	Read Only

Table A- 15 Volumeflow calibration

Modbus address	Data type / Size [bytes]	Parameter	Description	Default value [unit]	Value range	Access level
2103	Float / 4	Maximum Volumeflow Capacity	Maximum volumeflow measurement capacity of the sensor	Sensor size specific [m ³ /s] 1)	0 to 0.177	Read only

1): See Sensor dimension dependent default settings (Page 143).

A.3 Modbus holding registers tables

Table A- 16 Massflow calibration

Modbus address	Data type / Size [bytes]	Parameter	Description	Default value [unit]	Value range	Access level
2101	Float / 4	Maximum Massflow Capacity	Maximum massflow measurement capacity of the sensor	Sensor size specific [kg/s] 1)	0 to 1023	Read only
2402	Float / 4	Calibration Factor	Factory-set sensor-specific calibration factor. The calibration factor is shown on the sensor nameplate	-	Min: 5.00E+07 Max: 4.29E+09	Read only

1): See Sensor dimension dependent default settings (Page 143).

Table A- 17 Density calibration

Modbus address	Data type / Size [bytes]	Parameter	Description	Default value [unit]	Value range	Access level
2428	Float / 4	Density Calibration Offset	Specify an offset in the density flow calculation	-	-14 000 to +14 000	Read only
2430	Float / 4	Density Calibration Factor	Specify gain factor in the density flow calculation	-	-1.999 to +1.999	Read only
2432	Float / 4	Dens. Comp. Tube Temp.	Specifies a tube temperature coefficient in the density calculation	-	-0.001953 to +0.001953	Read only
2434	Float / 4	Dens. Comp. Frame Temp.	Specifies a frame temperature coefficient in the density calculation	-	-0.001953 to +0.001953	Read only

A.3.8 Simulation

Table A- 18 Simulation

Modbus address	Data type / Size [bytes]	Parameter	Description	Default value [unit]	Value range	Access level
2764	Float / 4	Massflow Simulation Value	Set massflow simulation value. The massflow will be set to this value on all outputs, if "Simulation Mass Flow" is enabled	0 [kg/s]	-1023 to +1023	Read / Write
2766	Float / 4	Density Simulation Value	Set density simulation value. The density will be set to this value on all outputs, if "Simulation Density" is enabled	1000 [kg/m ³]	-20000 to +20000	Read / Write
2768	Float / 4	Tube Temperature Simulation Value	Set tube temperature simulation value. The tube temperature will be set to this value on all outputs if "Simulation Tube Temperature" is enabled	0 [°C]	-50 to +200	Read / Write
2770	Float / 4	Frame Temperature Simulation Value	Set frame temperature simulation value. The frame temperature will be set to this value on all outputs if "Simulation Frame Temperature" is enabled	0 [°C]	-50 to +200	Read / Write
2772	Float / 4	Volumeflow Simulation Value	Set volume flow simulation value. The volume flow will be set to this value on all outputs, if "Simulation Volume Flow" is enabled	m ³ /s	-65 to +65	Read / Write
2780	Unsigned / 2	Enable Simulation	Activate simulation. Select one of the following values: <ul style="list-style-type: none"> • Bit 0: Massflow • Bit 1: Density • Bit 2: Volumeflow • Bit 3: Tube temperature • Bit 4: Frame temperature 	0	0 to 63	Read / Write

A.3.9 Alarms

Table A- 19 Alarms

Modbus address	Data type / Size [bytes]	Parameter	Description	Default value [unit]	Value range	Access level
3012	Unsigned / 4	Alarm Group 1	<p>The following bit is set in case of active alarm:</p> <ul style="list-style-type: none"> • Bit 4: Power Supply Malfunction • Bit 6: Temperature Circuit Malfunction • Bit 10: Measurement Out Of Range • Bit 14: Calibration Malfunction • Bit 15: Compensation Out Of Range • Bit 17: Pickup Malfunction • Bit 23: Driver Malfunction • Bit 26: Measurement Out Of Range • Bit 27: Mass Flow Max Limit Exceeded • Bit 28: Volume Flow Max Limit Exceeded • Bit 29: Density Max Limit Exceeded • Bit 30: Min Tube Temp Exceeded • Bit 31: Max Tube Temp Exceeded 	-	-	Read Only

Modbus address	Data type / Size [bytes]	Parameter	Description	Default value [unit]	Value range	Access level
3014	Unsigned / 4	Alarm Group 2	<p>The following bit is set in case of active alarm:</p> <ul style="list-style-type: none"> • Bit 0: Min Frame Temp Exceeded • Bit 1: Max Frame Temp Exceeded • Bit 2: Zero Sigma Limit Exceeded • Bit 3: Zero Offset Limit Exceeded • Bit 4: Quality Of Zero Point Conditions • Bit 5: Empty Pipe • Bit 6: Incomplete Filling • Bit 7: Storage Malfunction • Bit 8: System Internal • Bit 14: Unstable Measurement Conditions • Bit 15: Auto-filtering enabled • Bit 23: Sensor Startup 	-	-	Read Only

Sensor dimension dependent default settings

Massflow

Sensor dimension	Default value	Unit	Range
Low Flow Cut-Off			
DN 15	0.00884	kg/s	0 to +8.84
DN 25	0.0245	kg/s	0 to +24.5
DN 50	0.0982	kg/s	0 to +98.2
DN 80	0.251	kg/s	0 to +351

Volumeflow

Sensor dimension	Default value	Unit	Range
Low Flow Cut-Off			
DN 15	0.00000884	m ³ /s	0 to +0.00884
DN 25	0.0000245	m ³ /s	0 to +0.0245
DN 50	0.0000982	m ³ /s	0 to +0.0982
DN 80	0.000251	m ³ /s	0 to +0.251

Zero Point Adjustment

Sensor dimension	Default value	Unit	Range
Standard Deviation Limit			
DN 15	0.0004	kg/s	
DN 25	0.004	kg/s	
DN 50	0.015	kg/s	
DN 80	0.019	kg/s	
Offset Limit			
DN 15	0.031944444	kg/s	
DN 25	0.010277778	kg/s	
DN 50	0.144444444	kg/s	
DN 80	0.377777778	kg/s	

Zero point adjustment

In the following the automatic zero point adjustment function is described. For further details, see Zero point adjustment (Page 145).

Note

Preconditions

Before a zero point adjustment is initiated, the pipe must be flushed, filled and at an absolute flowrate of zero preferably also at operating pressure and temperature. Refer to Zero point adjustment (Page 65) for more details.

Note

Change of parameters during zero point adjustment

Do not change any other parameter during the zero point adjustment procedure.

Automatic zero point adjustment

The device measures and calculates the correct zero point automatically.

The automatic zero point adjustment of the flowmeter is set by the following parameters:

- Duration (Modbus address 2135)
- Start Zero Point Adjustment (Modbus address 2180)

When zero adjust is initiated by selecting "Start Zero Point Adjustment", the massflow values are acquired and totalized for the configured period (Duration). The default zero point adjustment period (30 s.) is normally sufficient for a stable zero point measurement.

Note

Extremely low flow quantity

If the flow quantity is extremely small, extremely precise measurement is necessary. In this case, a long zero point adjustment period can be selected for improved zero point adjustment.

Zero point calculation

During zero point adjustment, an average value is automatically calculated using the following formula:

Zero Point Offset Value		
Average of N flow values	$\bar{x} \equiv \frac{\sum_{i=1}^N x_i}{N}$	x_i is an instantaneous flow value sampled in the time domain N = Number of samples during zero point adjustment

The offset value must be within the determined "Zero Point Offset Limit" (Modbus address 2140).

Note

Exceeded zero point offset limit

If the offset value is greater than the configured limit, proceed as follows:

- Check that the tube is completely filled and that the flowrate is absolute zero.
 - Check the validity of the configured zero point offset limit.
 - Repeat the zero point adjustment.
-

Zero point standard deviation

After completion of the procedure, the standard deviation is calculated in accordance with the following formula:

Zero Point Standard Deviation	
Standard deviation of N values	$s \equiv \sqrt{\frac{\sum_{i=1}^N (x_i - \bar{x})^2}{N-1}} = \sqrt{\frac{-N\bar{x}^2 + \sum_{i=1}^N x_i^2}{N-1}}$

The standard deviation contains important feedback on the homogeneity of the fluid, for example on the presence of bubbles or particles.

The standard deviation must be within the determined "Standard Deviation Limit" (Modbus address 2138).

Note

Exceeded standard deviation limit

If the standard deviation is greater than the configured limit, proceed as follows:

- Check that the tube is completely filled and that the flow rate is absolute zero.
 - Check that the installation is vibration-free.
 - Check the validity of the configured standard deviation limit in parameter 2.6.4 "Standard deviation limit".
 - Repeat the zero point adjustment.
-

Successful automatic zero point adjustment

If the new zero point offset value is valid, it is automatically stored as the new zero point for the sensor. It remains stored in the case of a power failure.

Manual zero point adjustment

In case an automatic zero point adjustment cannot be performed, it is possible to do a manual zero point adjustment by entering the zero point offset value.

1. Select Modbus address 2132 "Zero Point Adjustment" and set the value to 1 = "Manual Zero Point Adjustment".
2. Select Modbus address 2133 "Manual Zero Point Offset" and enter the desired offset value.

CRC calculation

The Cyclical Redundancy Checking (CRC) field is two bytes, containing a 16-bit binary value. The CRC value is first generated by the transmitting device, which appends the CRC to the message. The receiving device recalculates a CRC during receipt of the message, and compares the calculated value to the actual value it received in the CRC field. If the two values are not equal an error occurs.

In the following a short text description of how the CRC is calculated is provided. This description is then followed by a C programming example.

CRC calculation

1. Load a 16-bit register with FFFF hex (all 1's). Call this the CRC register.
2. Exclusive OR the first 8-bit byte of the message with the low-order byte of the 16-bit CRC register, putting the result in the CRC register.
3. Shift the CRC register one bit to the right (toward the LSB), zero-filling the MSB. Extract and examine the LSB.
4. (If the LSB was 0): Repeat Step 3 (another shift). (If the LSB was 1): Exclusive OR the CRC register with the polynomial value 0xA001 (1010 0000 0000 0001).
5. Repeat Steps 3 and 4 until 8 shifts have been performed. When this is done, a complete 8-bit byte will have been processed.
6. Repeat Steps 2 through 5 for the next 8-bit byte of the message. Continue doing this until all bytes have been processed.
7. The final content of the CRC register is the CRC value.
8. When the CRC is placed into the message, its upper and lower bytes must be swapped as described below.

Placing the CRC into the Message

When the 16-bit CRC (two 8-bit bytes) is transmitted in the message, the low-order byte will be transmitted first, followed by the high-order byte.

For example, if the CRC value is 1241 hex (0001 0010 0100 0001):

Addr	Func	Data count	Data n	Data n+1	Data n+2	Data n+x	CRC LO	CRC HI
							0x41	0x12

CRC programming example

```
/* Table of CRC values for high-order byte */
static __flash unsigned char auchCRCHi[] = {
0x00, 0xC1, 0x81, 0x40, 0x01, 0xC0, 0x80, 0x41, 0x01, 0xC0, 0x80,
0x41, 0x00, 0xC1, 0x81,
```

```

0x40, 0x01, 0xC0, 0x80, 0x41, 0x00, 0xC1, 0x81, 0x40, 0x00, 0xC1,
0x81, 0x40, 0x01, 0xC0,
0x80, 0x41, 0x01, 0xC0, 0x80, 0x41, 0x00, 0xC1, 0x81, 0x40, 0x00,
0xC1, 0x81, 0x40, 0x01,
0xC0, 0x80, 0x41, 0x00, 0xC1, 0x81, 0x40, 0x01, 0xC0, 0x80, 0x41,
0x01, 0xC0, 0x80, 0x41,
0x00, 0xC1, 0x81, 0x40, 0x01, 0xC0, 0x80, 0x41, 0x00, 0xC1, 0x81,
0x40, 0x00, 0xC1, 0x81,
0x40, 0x01, 0xC0, 0x80, 0x41, 0x00, 0xC1, 0x81, 0x40, 0x01, 0xC0,
0x80, 0x41, 0x01, 0xC0,
0x80, 0x41, 0x00, 0xC1, 0x81, 0x40, 0x00, 0xC1, 0x81, 0x40, 0x01,
0xC0, 0x80, 0x41, 0x01,
0xC0, 0x80, 0x41, 0x00, 0xC1, 0x81, 0x40, 0x01, 0xC0, 0x80, 0x41,
0x00, 0xC1, 0x81, 0x40,
0x00, 0xC1, 0x81, 0x40, 0x01, 0xC0, 0x80, 0x41, 0x01, 0xC0, 0x80,
0x41, 0x00, 0xC1, 0x81,
0x40, 0x00, 0xC1, 0x81, 0x40, 0x01, 0xC0, 0x80, 0x41, 0x00, 0xC1,
0x81, 0x40, 0x01, 0xC0,
0x80, 0x41, 0x01, 0xC0, 0x80, 0x41, 0x00, 0xC1, 0x81, 0x40, 0x00,
0xC1, 0x81, 0x40, 0x01,
0xC0, 0x80, 0x41, 0x01, 0xC0, 0x80, 0x41, 0x00, 0xC1, 0x81, 0x40,
0x01, 0xC0, 0x80, 0x41,
0x00, 0xC1, 0x81, 0x40, 0x00, 0xC1, 0x81, 0x40, 0x01, 0xC0, 0x80,
0x41, 0x00, 0xC1, 0x81,
0x40, 0x01, 0xC0, 0x80, 0x41, 0x01, 0xC0, 0x80, 0x41, 0x00, 0xC1,
0x81, 0x40, 0x01, 0xC0,
0x80, 0x41, 0x00, 0xC1, 0x81, 0x40, 0x00, 0xC1, 0x81, 0x40, 0x01,
0xC0, 0x80, 0x41, 0x01,
0xC0, 0x80, 0x41, 0x00, 0xC1, 0x81, 0x40, 0x00, 0xC1, 0x81, 0x40,
0x01, 0xC0, 0x80, 0x41,
0x00, 0xC1, 0x81, 0x40, 0x01, 0xC0, 0x80, 0x41, 0x01, 0xC0, 0x80,
0x41, 0x00, 0xC1, 0x81,
0x40
} ;

```

```

/* Table of CRC values for low-order byte */
static __flash char auchCRCLo[] = {
0x00, 0xC0, 0xC1, 0x01, 0xC3, 0x03, 0x02, 0xC2, 0xC6, 0x06, 0x07,
0xC7, 0x05, 0xC5, 0xC4,
0x04, 0xCC, 0x0C, 0x0D, 0xCD, 0x0F, 0xCF, 0xCE, 0x0E, 0x0A, 0xCA,
0xCB, 0x0B, 0xC9, 0x09,
0x08, 0xC8, 0xD8, 0x18, 0x19, 0xD9, 0x1B, 0xDB, 0xDA, 0x1A, 0x1E,
0xDE, 0xDF, 0x1F, 0xDD,
0x1D, 0x1C, 0xDC, 0x14, 0xD4, 0xD5, 0x15, 0xD7, 0x17, 0x16, 0xD6,
0xD2, 0x12, 0x13, 0xD3,
0x11, 0xD1, 0xD0, 0x10, 0xF0, 0x30, 0x31, 0xF1, 0x33, 0xF3, 0xF2,
0x32, 0x36, 0xF6, 0xF7,
0x37, 0xF5, 0x35, 0x34, 0xF4, 0x3C, 0xFC, 0xFD, 0x3D, 0xFF, 0x3F,
0x3E, 0xFE, 0xFA, 0x3A,
0x3B, 0xFB, 0x39, 0xF9, 0xF8, 0x38, 0x28, 0xE8, 0xE9, 0x29, 0xEB,
0x2B, 0x2A, 0xEA, 0xEE,
0x2E, 0x2F, 0xEF, 0x2D, 0xED, 0xEC, 0x2C, 0xE4, 0x24, 0x25, 0xE5,
0x27, 0xE7, 0xE6, 0x26,
0x22, 0xE2, 0xE3, 0x23, 0xE1, 0x21, 0x20, 0xE0, 0xA0, 0x60, 0x61,
0xA1, 0x63, 0xA3, 0xA2,

```



```

0x62, 0x66, 0xA6, 0xA7, 0x67, 0xA5, 0x65, 0x64, 0xA4, 0x6C, 0xAC,
0xAD, 0x6D, 0xAF, 0x6F,
0x6E, 0xAE, 0xAA, 0x6A, 0x6B, 0xAB, 0x69, 0xA9, 0xA8, 0x68, 0x78,
0xB8, 0xB9, 0x79, 0xBB,
0x7B, 0x7A, 0xBA, 0xBE, 0x7E, 0x7F, 0xBF, 0x7D, 0xBD, 0xBC, 0x7C,
0xB4, 0x74, 0x75, 0xB5,
0x77, 0xB7, 0xB6, 0x76, 0x72, 0xB2, 0xB3, 0x73, 0xB1, 0x71, 0x70,
0xB0, 0x50, 0x90, 0x91,
0x51, 0x93, 0x53, 0x52, 0x92, 0x96, 0x56, 0x57, 0x97, 0x55, 0x95,
0x94, 0x54, 0x9C, 0x5C,
0x5D, 0x9D, 0x5F, 0x9F, 0x9E, 0x5E, 0x5A, 0x9A, 0x9B, 0x5B, 0x99,
0x59, 0x58, 0x98, 0x88,
0x48, 0x49, 0x89, 0x4B, 0x8B, 0x8A, 0x4A, 0x4E, 0x8E, 0x8F, 0x4F,
0x8D, 0x4D, 0x4C, 0x8C,
0x44, 0x84, 0x85, 0x45, 0x87, 0x47, 0x46, 0x86, 0x82, 0x42, 0x43,
0x83, 0x41, 0x81, 0x80,
0x40
} ;

unsigned short int CRC16(unsigned char *puchMsg, unsigned short int
usDataLen)
{
    unsigned char uchCRCHi = 0xFF; /* high byte of CRC initialized */
    unsigned char uchCRCLo = 0xFF; /* low byte of CRC initialized */
    unsigned uIndex ;             /* will index into CRC lookup
table */
    while(usDataLen--)           /* pass through message buffer */
    {
        uIndex = uchCRCHi ^ *puchMsg++ ; /* calculate the CRC */
        uchCRCHi = uchCRCLo ^ auchCRCHi[uIndex] ;
        uchCRCLo = auchCRCLo[uIndex] ;
    }
#ifdef INTEL_LIKE_PROCESSOR
    return (unsigned short int)((uchCRCLo << 8) | uchCRCHi);
#else
    return (unsigned short int)((uchCRCHi << 8) | uchCRCLo);
#endif
}

```

See also

There are many ways of calculating a CRC checksum. For further information, please refer to the Modbus Organisation Website (<http://www.modbus.org>), where detailed descriptions and programming examples are available.

Exception codes

E.1 Exception handling

There is a defined set of exception codes to be returned by slaves in the event of problems. All exceptions are signalled in the response from the slave by adding 80 hex to the function code of the request and following this byte by an exception code.

Table E- 1 Exception codes

Exception code (dec)	Exception text	Description
01	Illegal function	The function code received in the query is not an allowable action for the slave
02	Illegal data address	The data address received in the query is not an allowable address for the slave.
03	Illegal data value	A value contained in the query data field is not an allowable value for the addressed location. This may indicate a fault in the structure of the remainder of a complex request, such that the implied length is incorrect or the number of registers is too high.
04	Slave device failure	The request is for some other reason not acceptable. It may e.g. indicate that the data value to write is evaluated to be beyond limits.

Float definition

F.1 Float definition

Stuffing of multi-byte numbers into multiple Modbus RTU registers differs among Modbus devices. "Big Endian" and "Little Endian" describe the order or sequence in which multi-byte data is stored in memory. This device uses (IEEE 741) a "Big-Endian" representation for addresses and data items as default. This means that when a numerical quantity larger than a single byte is transmitted, the MOST significant byte is sent first.

Float transmission order can be changed as described in Float transmission (Page 78).

Following example describes the Big-Endian representing of float IEEE741.

Value (decimal)	IEEE FP B MSB LSB	Register N		Register N + 1	
		high	low	high	low
100.0	42C80000h	42h	C8h	00h	00h
55.32	425D47AEh	42h	5Dh	47h	AEh
2.0	40000000h	40h	00h	00h	00h
1.0	3F800000h	3Fh	80h	00h	00h
-1.0	BF800000h	bFh	80h	00h	00h

Read absolute massflow (4.03001)

Query: 01,03,0B,B8,00,02,46,0A
 Response: 01,03,04,40,C3,52,93,62,C8
 Absolute massflow = 6.10383 kg/s

Glossary

Coriolis

The Coriolis effect is an apparent deflection of moving objects from a straight path when they are viewed from a rotating frame of reference. The effect is named after Gaspard-Gustave Coriolis, a French scientist who described it in 1835. The Coriolis effect is caused by the Coriolis force, which appears in the equation of motion of an object in a rotating frame of reference.

CRC Cyclic Redundancy Check

Cyclic Redundancy Check is used for error checking in Modbus RTU.

EHDG

European Hygienic Engineering & Design Group was founded in 1989 to promote hygienic engineering in the European food industry. EHEDG provides practical guidance on hygienic engineering aspects of manufacturing safe and wholesome foods.

EMC

Electromagnetic compatibility (EMC) is the branch of electrical sciences which studies the unintentional generation, propagation and reception of electromagnetic energy with reference to the unwanted effects (Electromagnetic Interference, or EMI) that such energy may induce. The goal of EMC is the correct operation, in the same electromagnetic environment, of different equipment which use electromagnetic phenomena, and the avoidance of any interference effects.

IP

An IP (Ingress Protection) number is used to specify the environmental protection of enclosures around electronic equipment. These ratings are determined by specific tests. The IP number is composed of two numbers, the first referring to the protection against solid objects and the second against liquids. The higher the number, the better the protection. For example, in IP67 the first Number (6) means that the device is totally protected against dust, and the second (7) that it is protected against the effect of immersion between 15cm and 1m

Modbus

Modbus is a serial communications protocol intended for use with programmable logic controllers (PLCs). Modbus allows for communication between many devices connected to the same network, for example a system that measures temperature and humidity and communicates the results to a computer. Modbus is often used to connect a supervisory computer with a remote terminal unit (RTU) in supervisory control and data acquisition systems.

Modbus address

Throughout this document the following notation is used to address Modbus RTU registers:

4: 1234: Holding register 1234 (addressed in messages by 1233)

4: 54321: Holding register 54321 (addressed in messages by 54320)

34567: The address of a holding register as specified in a message

Modbus master

A Modbus master is a Modbus device which is able to access data in one or more connected Modbus slaves.

Modbus slave

A Modbus slave is a Modbus device which is able to respond to requests from a single Modbus master.

NAMUR

Normenarbeitsgemeinschaft für Meß- und Regeltechnik in der Chemischen Industrie (NAMUR). NAMUR is a group representing the interests of the chemical industry which create standards for instrumentation and electrical devices used in industrial plants.

PED

The Pressure Equipment Directive (97/23/EC) is the legislative framework on European level for equipment subject to a pressure hazard. It was adopted by the European Parliament and the European Council in May 1997 and has been obligatory throughout the European Union since May 2002.

Zero point adjustment

In order to measure accurately with a measuring instrument it is important that zero and gain have been calibrated. All Coriolis sensors are calibrated before they are sent out to customers. However, Coriolis sensors are very sensitive, and several factors might move the zero point, for example installation, pressure, temperature and even very small vibrations coming from the process. All these factors are customer specific and can't be simulated at the factory. Therefore Siemens recommends to carry out a zero point adjustment before use.

Index

A

- Accuracy
 - Density, 97
 - Massflow, 97
 - Temperature, 98
- Approval nameplate
 - Sensor, 12

C

- Cable specifications, 39, 104
- CE mark, 15
- Certificates, 15
- Certificates and approvals, 106
- Characteristics
 - Density calibration, 138
 - Massflow calibration, 138
 - Sensor, 137
 - Volumeflow calibration, 137
- Commissioning
 - Steps, 52
- Communication
 - Modbus, 136
- Communication parameters
 - Setup, 54
- Compliance
 - European directives, 15
- Contact person, 14
- Coriolis
 - Applications, 21
 - Measurement principle, 25
- Correct usage, (See improper device modifications)
- Cross talk, 34, 92
- Customer Support Hotline, 84

D

- Design, 22
- Design, sensor, 103
- Designated use, 95
- Device
 - Identification, 9, 11, 12
- Diagnose
 - with SIMATIC PDM, 89
- Dimensions and weight, 115

Document history, 7

E

- Electrical connection
 - Cable specifications, 39
 - In hazardous area, 39
- Empty tube monitoring, 72
- Exception codes, 153

F

Flow direction, 30

H

- Handling, 33
- Hazardous area
 - Electrical connection, 39
 - Laws and directives, 15
- Hazardous locations
 - Approvals, 17
- Hot swapable, 114
- Hotline, 84

I

- Identification
 - Sensor, 127
- Identification nameplate
 - Sensor, 9
- Improper device modifications, 16
- Installation
 - Drop line, 32
 - Gas, 29
 - Incorrect, 92
 - Indoor/outdoor, 27
 - Inlet / Outlet conditions, 29
 - Liquid, 29
 - Location in the system, 29
 - Mounting of sensor, 33
 - Orienting the sensor, 31
 - Pressure guard, 35
 - Safety instructions, 27
 - Upstream / Downstream, 29
- Installation torques, 105

Internet

- Contact person, 14, 85
- Flow documentation, 14
- Modbus Organisation, 24
- Support, 85

L

- Low flow cut-off, 72, 92
- Low Mass Flow Cut-Off, 72
- Low Volume Flow Cut-Off, 72

M

- Maintenance, 83
- Maintenance and Diagnostics
 - Access level, 132
 - Aerated flow, 133
 - Device diagnostics, 132
 - Maintenance, 132
 - Zero point adjustment, 134
- Modbus
 - Features, 23
 - Frame, 24
 - Network, 54
 - Organisation Website, 24
 - Technical data, 96
 - Technology, 24
- Modbus holding registers
 - Alarms, 140
 - Characteristics, 137
 - Communication, 136
 - Identification, 127
 - Maintenance & Diagnostics, 132
 - Process values, 127
 - Setup, 129
 - Simulation, 139
 - Totalizer, 131
- Mounting, (See Installation)

P

- PDM
 - Commissioning steps, 52
 - Zero point adjustment, 65
- Performance, 97
- Power supply, 104
- Pressure
 - Safety instructions, 27
- Process noise damping, 73
- Process values, 69, 127

- Process variables, 95

R

- Rated operating conditions, 98
- Recalibration, 84
- Reference conditions, 97
- Repair, 83

S

- Safety
 - Sensor installation, 27
- Scope of delivery, 8
- Sensor orientation, (See Installation)
- Service, 83, 85
- Service information, 83
- Setup
 - Density, 130
 - Massflow, 130
 - Operating conditions, 129
 - Volume flow, 130
- Signal processing, 26
- Simulation, 78, 139
- Specification nameplate
 - Sensor, 11
- Support, 85
- Symbols, (Refer to warning symbols)
- System design, 95
- System integration, 23, 45

T

- Technical data, 95
- Temperature specifications, 17
- Termination DIP switches, 44
- Test certificates, 15
- Totalizer, 131

U

- Unicast communication mode, 24

V

- Vibrations, 34, 92

W

Warning symbols, 15

Z

Zero point adjustment, 65, 70, 145
 Automatic, 70, 145
 via PDM, 65

For more information

www.siemens.com/flow

Siemens A/S
Flow Instruments
Nordborgvej 81
DK-6430 Nordborg

Subject to change without prior notice
Order No.: A5E33120874
Lit. No.: A5E33120874-001
© Siemens AG 12.2013



A5E33120874

www.siemens.com/processautomation