

DIGITAL METERS

Frequency/Pulse Input Meter
Rate/Totalizer/Batch Controller

Model PD693 Instruction Manual



- Pulse, Open Collector, NPN, PNP, TTL, Switch, or Square Wave Inputs
- Full Six Digit Display for Total, 4½ Digit + Extra Zero for Rate
- Display in Engineering Units; Rate per Second, Minute, or Hour
- K-Factor, Internal, or External Calibration
- Scale Without a Calibrator or Calibrate with a Signal Source
- 11-Point Linearization for Non-Linear Inputs
- Low-Flow Cutoff
- NEMA 4X, IP65 Front Panel
- 12 or 24 VDC Field Selectable Sensor Supply Standard on AC Models
- 115 VAC, 230 VAC, or 24 VDC Power Options
- Quick Preset Change Feature for Batch Control
- 2 or 4 Relays +/- 4-20 mA Output Options

PRECISION DIGITAL CORPORATION
19 Strathmore Road • Natick MA 01760 USA
Tel (800) 610-5239 • Fax (508) 655-8990



www.predig.com

Table of Contents

INTRODUCTION	6
Features	6
Ordering Information	7
Specifications	9
Basic Rate Meter	9
Rate/Totalizer/Batch Controller Features	12
Options	13
Display Functions and Messages	16
SETUP AND PROGRAMMING	18
Overview	18
Jumpers and Switch Configuration	19
Overview	19
Jumper Arrays & Switch Function	19
Connections	21
Overview	21
Wiring Instructions	21
AC Power and Signal Connector	22
DC Model Power and Signal Connector	22
Power Connections	23
Signal Connections	24
Acknowledgement, Reset Total Connections	26
Optional Relays and 4-20 mA Output Terminals	27
Isolated 4-20 mA Output Option Connections	28
Programming	29
Overview	29
General Programming Description	29
ENTER and ACK Functionality	29
Five Basic Digit/Display Setting Instructions	30
Basic Meter Programming	32
Overview	32
Quit Menu Scroll, Diagnostic, and Calibration	32
Minimum Input Span (<i>Error</i> Message)	32
Select Input Signal	33
Select K-Factor, Calibration, or Scaling Method	34
Set Rate and Total Decimal Point	35
Scale or Calibrate the Meter	36
Scale Using K-Factor (<i>F_RC_TO_R</i>)	36
Scale Using Internal Calibration (<i>I-ϵRL</i>)	36
Calibration Error (<i>Error</i>)	37
Calibrate Using External Calibration (<i>E-ϵRL</i>)	39

Gate Function (GATE)-----	40
Programming the Gate (GATE)-----	40
Contact De-Bounce Filter (FILTERR)-----	41
Gate and Filter Settings-----	41
Rate Meter Setup-----	42
Overview-----	42
Set Display to Rate (dSPY r)-----	42
Low-Flow Cutoff Programming (LOWOFF)-----	43
Totalizer Programming-----	44
Overview-----	44
Set Display for Total (dSPY t)-----	44
Set Rate Time Base (tBASE)-----	45
Set Totalizer Conversion Factor (tOLF)-----	45
Set Totalizer Decimal Point-----	47
Set Alternating Total/Rate Display-----	48
Parameter Combinations Resulting in Error 1 Message-----	48
Set Point Setup and Programming-----	49
Overview-----	49
Set Relays for Manual or Automatic Reset-----	50
Set Relays for Fail-Safe Operation-----	50
Assigning Set Points to Rate or Total (SETP)-----	51
Rate or Total, Latching or Non-Latching Relays (SETUP)-----	52
Programming Internal Total Reset and Delay (dELRY)-----	55
Programming Alarm Points and Presets (SETPES)-----	56
Overview-----	56
Set and Reset Points for Rate Alarms-----	56
Preset Values for Total Set Points-----	56
Preset Offset Values for Total Set Points (OFFSET)-----	56
Programming Alarm and Preset Values (SETPES)-----	57
Isolated 4-20 mA Output Programming (OUTPUT)-----	60
4-20 mA Output Programming Confirmation-----	60
Lockout and Display Selection Programming-----	61
Overview-----	61
Lockout-----	61
Display Selection (dSPLY)-----	62
Include or Exclude Menu Titles from Menu Scroll-----	64
Alternating Display-----	65
OPERATION-----	66
Overview-----	66
Two Types of Display: Rate and Total-----	67
Basic Meter Operation-----	68
Overview-----	68

ENTER and ACK Button Operation-----	68
Display Peak & Reset Peak Operation (<i>d5PY P & r5Et P</i>) -----	69
Rate Meter Operation-----	70
Overview-----	70
Display Rate (<i>d5PY r</i>)-----	70
Low-Flow Cutoff (<i>LtOFF</i>)-----	70
Totalizer Operation-----	71
Overview-----	71
Display Total (<i>d5PY t</i>)-----	71
Total Conversion Factor (<i>tot CF</i>) and Time Base (<i>t bASE</i>)-----	71
Applications Using Conversion Factor and Time Base-----	72
Totalizer Reset -----	73
Resetting Total Using the ENTER Button-----	73
Resetting Total via External Contact Closure-----	73
Resetting Total Automatically via User Selectable Preset-----	73
Relays Operation -----	74
Overview-----	74
Relays Auto Initialization-----	74
Fail-Safe Operation -----	74
Front Panel LEDs-----	75
Latching and Non-Latching Relay Operation-----	75
Acknowledging Relays -----	78
Delay on Release (<i>dELRY</i>)-----	78
Priority Batch Programming or Quick Presets-----	78
Switching Inductive Loads-----	79
Switching AC and DC Loads-----	79
Switching Low Voltage DC Loads -----	79
RC Networks Available from Precision Digital-----	79
Lockout and Display Selection Operation -----	80
Overview-----	80
Low Voltage Detector -----	80
Diagnostic (<i>d I99</i>) Feature -----	80
Overview-----	80
Operation-----	80
Reset Meter to Factory Defaults-----	80
OPTIONS CARD REMOVAL & INSTALLATION-----	81
PROGRAMMED PARAMETER SETTINGS -----	83
MOUNTING DIMENSIONS-----	86
OTHER PRECISION DIGITAL PRODUCTS-----	87

List of Figures

Figure 1.	Input Signal Selection & Lockout	19
Figure 2.	Relay Acknowledge Enable & Fail-Safe Jumper.....	20
Figure 3.	AC Power & Signal Connector Diagram	22
Figure 4.	DC Power & Signal Connector Diagram	22
Figure 5.	Input Power Connections	23
Figure 6.	Flowmeter Powered by Internal Power Supply	24
Figure 7.	Flowmeter Powered by External Supply	24
Figure 8.	Self-Powered Magnetic Pickup Flowmeter.....	25
Figure 9.	Open Collector Transistor Output	25
Figure 10.	Switch Contact Closure	26
Figure 11.	External Control Connections.....	26
Figure 12.	Connectors Location - Rear View of Meter	27
Figure 13.	Output Loop Powered by Meter	28
Figure 14.	Output Loop Powered from External Supply	28
Figure 15.	K-Factor Scaling Flowchart.....	31
Figure 16.	Input Signal Selection & Lockout	33
Figure 17.	Functions Locked Out with Lockout Jumper.....	61
Figure 18.	Menu Titles Excluded with <i>d5PLAY</i> Menu	63
Figure 19.	Meter Displaying Process/Rate	67
Figure 20.	Meter Displaying Total	67
Figure 21.	AC and DC Loads Protection	79
Figure 22.	Low Voltage DC Loads Protection.....	79
Figure 23.	Front Cover Removal	81
Figure 24.	Options Card Installation.....	82
Figure 25.	Mounting Dimensions.....	86
Figure 26.	Panel Cutout Dimensions	86

INTRODUCTION

This instrument is a frequency/pulse input meter with flow rate, totalizer, and batch control capabilities housed in a 1/8 DIN high-impact plastic enclosure with a NEMA 4X front. It accepts pulse (± 125 mV to ± 12 V), square wave (0-5 V, 0-12 V, or 0-24 V), open collector (NPN or PNP), TTL, or switch contact closure signals; and displays these signals in engineering units on a 0.56" high 4½ digit LED display. The meter also provides one isolated 12 VDC or 24 VDC power supply to drive either the input or output loops. Options include up to 4 relays for alarms or batch controlling as well as an isolated 4-20 mA transmitter output.

Features

Precision Digital is committed to improving its products and this model contains several features of interest:

- Relay Fail-Safe Jumper Easily Accessible on Display Board
- Programmable Set Points for Latching and Non-latching Operation
- Any Set Point Programmable for Rate or Total
- Quit Main Menu Scroll, Diagnostic, and Calibration with ACK Button
- Programmable Gate Function for Slow Pulse Rates
- Programmable Contact De-Bounce Filter for Noisy Contacts
- Diagnostic Menu for Troubleshooting Programmed Parameters

Ordering Information

115 VAC Model	230 VAC Model	24 VDC Model	Options Installed	Option Card*
PD693-3-N	PD693-4-N	PD693-2-N	No Options	
PD693-3-14	PD693-4-14	PD693-2-14	2 Relays	PD174
PD693-3-15	PD693-4-15	PD693-2-15	4-20 mA Out	PD175
PD693-3-16	PD693-4-16	PD693-2-16	2 Relays + 4-20 mA Out	PD176
PD693-3-17	PD693-4-17	PD693-2-17	4 Relays	PD177
PD693-3-18	PD693-4-18	PD693-2-18	4 Relays + 4-20 mA Out	PD178

Ordering example: PD693-3-14, frequency/pulse input meter powered from 115 VAC (-3) with 2 relays (-14).

* Part numbers for option cards when purchased separately.

Safety Notice



CAUTION: Read complete instructions prior to installation and operation of the meter.



WARNING: Risk of electric shock.



Observe all safety regulations. Electrical wiring should be performed in accordance with all applicable national, state and local codes to prevent damage to the meter and ensure personnel safety.

Do not use this meter to directly drive heavy equipment such as pumps, motors, valves, etc.



It is recommended to use this meter in a fail-safe system that accommodates the possibility of meter failure or power failure.



WARNING

Hazardous voltages exist within enclosure. Installation and service should be performed only by trained service personnel.



AVERTISSEMENT

Les pièces à l'intérieur du boîtier portent des tensions dangereuses. Seules des personnes qualifiées et bien entraînées devraient entreprendre l'opération et la maintenance.

Disclaimer

The information contained in this document is subject to change without notice. Precision Digital makes no representations or warranties with respect to the contents hereof, and specifically disclaims any implied warranties of merchantability or fitness for a particular purpose.

Specifications

Except where noted all specifications apply to operation at +25°C.

Basic Rate Meter

INPUTS	Field selectable: Pulse or square wave 0-5 V, 0-12 V, or 0-24 V @ 30 kHz; TTL; open collector 4.7 k Ω pull-up to 12 V @ 30 kHz; NPN or PNP transistor, switch contact 4.7 k Ω pull-up to 12 V @ 40 Hz.
LOW VOLTAGE MAG PICKUP (Isolated)	Sensitivity: 125 mVp-p Hysteresis: 30 mV
MINIMUM INPUT FREQUENCY	0.0101 Hz Minimum frequency is dependent on high gate setting.
MAXIMUM INPUT FREQUENCY	30,000 Hz
INPUT IMPEDANCE	Pulse input: Greater than 300 k Ω @ 1 kHz. Open collector/switch input: 4.7 k Ω pull-up to 12 V.
DISPLAY	Six digit, 0.56" (14.2 mm) red seven-segment LED Rate: -19999(0) to 29,999(0) with selectable extra zero Total: 0 to 999,999; automatic lead zero blanking
DECIMAL POINT	Rate: 2.9999, 29.999, 299.99, 2999.9, or extra zero may be turned on 299990 Total: 9.99999, 99.9999, 999.999, 9999.99, 99999.9 Rate and total decimal points are independent of each other.
CALIBRATION	May be calibrated using K-factor, internal calibration, or by applying an external calibration signal.
K-FACTOR	Field programmable K-factor converts input pulses to rate in engineering units. May be programmed from 0.00001 to 999,999 pulses/unit.
MULTI-POINT LINEARIZATION	2 to 11 points Meter may be calibrated or scaled using up to 11 points.
CALIBRATION RANGE	Input 1 signal may be set anywhere in the range of the meter; input 2 signal may be set anywhere above or below input 1 setting. An <i>Error</i> message will appear if input 1 and input 2 signals are too close together. Minimum input span between any two inputs is 3 Hz.

FILTER	Programmable contact de-bounce filter: 40 to 950 Hz maximum input frequency allowed (Low speed filter).
TIME BASE	Seconds, minutes, or hours
GATE	Low gate: 1-98 seconds High gate: 2-99.9 seconds
OUTPUT POWER	Isolated power supply field selectable, 12 VDC @ 50 mA for sensor or 24 VDC \pm 5% @ 20 mA for output transmitter, regulated. Maximum loop resistance is 1200 Ω (AC powered units only).
ACCURACY	\pm 0.1% FS
ALARM POINTS	Four, any combination of high or low alarms
ALARM POINT DEADBAND	0-100% FS, user selectable
ALARM STATUS INDICATION	Front panel LED
PEAK HOLD (MAX DISPLAY)	Captures the peak rate and displays it via the front panel ENTER button (dSPY P)
PEAK HOLD INDICATION	Front panel flashing R LED
LOCKOUT	Jumper JP2 restricts modification of calibration values.
NON-VOLATILE MEMORY	All programming and totalizer values are stored in non-volatile memory for a minimum of ten years if power is lost.
POWER OPTIONS	AC power: 115 or 230 VAC \pm 10%, 50/60 Hz, 12 VA DC power: 22-28 VDC, 6 watts maximum
ISOLATION	AC powered: 1500 VAC; DC powered: 500 VDC
ENVIRONMENTAL	Operational ambient temperature range: 0 to +60°C Storage temperature range: -40 to +85°C Relative humidity: 0 to 90% non-condensing
ENCLOSURE	1/8 DIN, high impact plastic, UL 94V-0
FRONT PANEL	Type 4X, NEMA 4X, IP65; panel gasket provided. Some applications require the use of silicone RTV to ensure a Type 4X seal (PDX690 Kit provided).
MOUNTING	1/8 DIN panel cutout required. Two panel mounting brackets provided.

OVERALL DIMENSIONS	2.30 x 4.25 x 5.30 in (58 x 108 x 135 mm)
WEIGHT	19.7 oz (559 g) (including options)
CONNECTIONS	Removable screw terminal blocks, accept 12 to 22 AWG wire
WARRANTY	2 years parts & labor
EXTENDED WARRANTY	1 or 2 years, refer to the Price List for details.

UL FILE NUMBER	E160849; 508 Industrial Control Equipment. (AC powered models only)
-----------------------	--

Rate/Totalizer/Batch Controller Features

RATE DISPLAY INDICATION	LED labeled R on right illuminates when meter is displaying rate input.
LOW-FLOW CUTOFF	<p>Any input below the low-flow cutoff value will result in a display of zero. May be set from 1 count to 100% F.S., user selectable. To disable low-flow cutoff, program cutoff value to zero.</p> <p>In multi-point calibration/scaling, the total is based on the rate display; so, inputs below the low-flow cutoff value will not affect the totalizer.</p> <p>In K-factor scaling, the totalizer ignores the low-flow cutoff; the totalizer counts every incoming pulse regardless of the rate display.</p>
ALTERNATING DISPLAY	Display may be programmed to alternate between rate and total every 10 seconds.
TOTAL DISPLAY	0 to 999,999; automatic lead zero blanking
TOTAL DECIMAL POINT	<p>May be set in any of the following positions: 9.99999, 99.9999, 999.999, 9999.99, or 99999.9</p> <p>Total and rate decimal points are independent.</p>
TOTAL CONVERSION FACTOR	<p>Programmable from 0.00001 to 59999.</p> <p>This is a multiplier applied to the rate display to obtain the total in any engineering units.</p>
TOTALIZER	<p>In multi-point calibration/scaling, the meter calculates the total based on rate display and field programmable total conversion factor to display total in engineering units. Time base must be selected according to time units in which rate is displayed.</p> <p>In K-factor scaling, the meter calculates the total based on the input pulses, K-factor value, and total conversion factor.</p>
TOTALIZER ROLLOVER	Totalizer rolls over when display exceeds 999,999. Relay status reflects the display.
TOTALIZER PRESETS	Up to four, user selectable under setup menu SEtUP . Any set point can be assigned to total and may be programmed anywhere in the range of the meter.
PRESET OFFSET	Relays assigned to total can be programmed to trip at any point below the next relay's preset value.

PROGRAMMABLE DELAY ON RELEASE	If the meter is programmed to reset total to zero automatically when the highest preset is reached, then a delay will occur before the total relays reset. This delay can be programmed anywhere between 1 and 999 seconds.
PRIORITY BATCH PROGRAMMING	This feature allows the user to quickly change preset values without going into the main menu by holding the ENTER button for more than 3 seconds.
TOTAL RESET	Via front panel ENTER button, external contact closure, or automatically via user selectable preset.
TOTAL RESET LOCKOUT	Meter may be programmed so total cannot be reset from the front panel.

Options

Relays

RATING	2 or 4 SPDT (Form C); rated 2 A @ 30 VDC or 2 A @ 250 VAC resistive load; $\frac{1}{14}$ HP @ 125/250 VAC for inductive loads
ASSIGNED TO RATE OR TOTAL	Any relay may be assigned to rate or total.
ELECTRICAL NOISE SUPPRESSION	A suppressor (RC network) to prolong the life of the relays should be connected to each relay contact switching inductive loads. The suppressor provides a degree of protection against electrical noise caused by inductive loads. Recommended suppressor value, 0.01 μ F/470 Ω , 250 VAC. See page 79.
DEADBAND	0-100% FS, user selectable
HIGH OR LOW ALARM	User may program any alarm for a high or low trip point.
RELAY OPERATION	Latching or non-latching, field selectable
FAIL-SAFE OPERATION	Relay coils are energized in non-alarm condition. In case of power failure, relays will go to alarm state. Fail-safe operation may be disabled, by removing jumper JP6 located on the Display Board.
AUTO INITIALIZATION	When power is applied to the meter, relays assigned to total will reflect the state of the accumulated total value in memory. Relays assigned to rate will reflect the state of the input to the meter.

RELAYS RESET	User select via JP3 jumper array and 5E <u>u</u> P menu
Total relays reset	<p>When total is reset to zero, if set up for external total reset</p> <p>After delay has elapsed, if set up for internal total reset</p> <p>Manual any time, if set up for external total reset (via user supplied external contact closure at terminals AK and CM or front panel ACK button)</p> <p>Manual reset resets all manually resettable relays.</p>
Rate relays reset	<p>Automatic reset only</p> <p>Manual reset only, at any time</p> <p>Automatic plus manual reset at any time</p> <p>Manual reset only after alarm condition has been corrected</p> <p>Automatic reset: Relays will automatically reset when the input passes the reset point.</p> <p>Manual reset: Performed via user supplied external contact closure at terminals AK and CM or front panel ACK button. Manual reset resets all manually resettable relays.</p>

Isolated 4-20 mA Transmitter Output

CALIBRATION RANGE

The transmitter output can be calibrated so that a 4 mA output is produced for any rate measured by the meter. The 20 mA output may correspond to any rate that is at least 501 counts greater or smaller than the rate corresponding to 4 mA. (Ex. 4 mA = 0, 20 mA = 501) If the span between 4 and 20 mA is less than 501 counts, an *Error* message will appear.

NO EQUIPMENT NEEDED

The 4-20 mA output from the meter is calibrated without the use of a calibrator.

OUTPUT LOOP POWER

24 VDC \pm 5% @ 20 mA, regulated
Maximum loop resistance is 1200 Ω . Output loop is isolated from input.

ACCURACY

\pm 0.1% FS \pm 0.004 mA

ISOLATION

500 VDC or peak AC, input-to-output or input/output-to-24 VDC supply

EXTERNAL LOOP-POWER SUPPLY

35 VDC max

OUTPUT LOOP RESISTANCE

Power supply	Minimum	Maximum
24 VDC	10 Ω	600 Ω
35 VDC (external)	600 Ω	1000 Ω

Display Functions and Messages

The meter displays various functions and messages during operation and programming. The following table shows the various displayed functions and messages with their description.

Display	Parameter	Description/Comments
18888L	Low Voltage	Indicates an input voltage below specifications during power up.
- 19999	Underrange	Indicates the input signal is below the negative range of the meter.
2 PLS	2 Points	Indicates number of calibration points selected (2 to 11 points can be selected).
29999	Overrange	Indicates the input signal exceeds the full-scale range of the meter.
CAL 1b	External Calibration	Calibrates meter using a calibrated signal source.
Cutoff	Low-Flow Cutoff	Sets meter to display zero below programmed cutoff point.
dECPt	Decimal Point	Sets the decimal position for total and rate
dELAY	Delay	Sets delay on release between 1 and 999 seconds for internal total reset.
dIAG	Diagnostic	Displays parameter settings one at a time for diagnostic purposes. Setting cannot be changed under this function.
dSPLAY	Display	Sets menu title scroll, selections are activated with lockout jumper installed.
dSPY 1	Display 1	Value displayed at input 1.
dSPY 2	Display 2	Value displayed at input 2.
dSPY P	Display Peak	Displays the highest rate value captured.
dSPY r	Display Rate	Sets rate as default display.
dSPY t	Display Total	Sets total as default display.
E rSt	External Total Reset	Indicates total does not reset to zero when preset value is reached.
E-CAL	External Calibration	Sets meter to be calibrated using a calibrated signal source.
Error	Error	Indicates calibration was not successful.
Error 1	Error 1	Indicates a combination of parameters that exceeds the totalizer capabilities.
FActoR	K-factor Scaling	Programs unit to convert input pulse to rate in engineering units.
F ILtEr	Filter	Sets filter value from 2 to 50. Maximum frequency is 950 to 40 Hz respectively.
GAte	Gate	Sets low and high gate values to allow rate display of slow pulse rates.

Display	Parameter	Description/Comments
Hour	Hour	Sets time base to display rate in units per hour.
H I	High Gate	Sets high gate value from 2.0 to 99.9
H I SPd	High Speed Filter	Sets meter to high speed filter. Maximum frequency is 30,000 Hz.
I or E	Internal or External	Sets operation of total reset; internal or external.
I rSEt	Internal Total Reset	Indicates total will reset to zero when highest preset value is reached.
I-CAL	Internal Calibration	Sets meter for internal calibration to scale meter without applying an input signal.
InPt 1	Input 1	Sets Input 1 value.
InPt 2	Input 2	Sets Input 2 value.
LATCH	Latch	Sets rate set points for latching or non-latching relay operation.
LO	Low Gate	Sets low gate value from 1.0 to 98.9
LO SPd	Low Speed Filter	Sets meter for low speed filter. Maximum frequency is 950 Hz.
rr in	Minute	Sets time base to display rate in units per minute.
no Pts	Number of Points	Sets meter for 2 to 11 calibration points.
OFFSEt	Preset Offset	Sets preset offset value (relay n trips at a point below relay n+1 preset value).
outPut	Output	Sets the optional 4-20 mA output values.
Pts	Multi-Point Calibration	Selects internal or external, multi-point calibration. Power up meter with ENTER button pressed.
r or t	Rate or Total	Assigns relay set points to rate or total.
rALE	Rate	Sets rate decimal point, or it Indicates set point was assigned to rate.
rSEt P	Reset Peak	Erases peak value from memory and captures a new peak reading.
rSEt t	Reset Total	Resets the totalizer to zero.
SCALE	Scale	Scales meter using internal calibration for desired display (signal source not required).
SEC	Second	Sets time base to display rate in units per second.
SEt 1	Set Point 1	Sets operation and value for set point 1.
SEt 2	Set Point 2	Sets operation and value for set point 2.
SEt 3	Set Point 3	Sets operation and value for set point 3.
SEt 4	Set Point 4	Sets operation and value for set point 4.

Display	Parameter	Description/Comments
SETPES	Set Points	Sets alarm set /reset points and total presets.
SEtUP	Setup	Sets operation of set points for rate or total, latching or non-latching, etc.
t bASE	Time Base	Sets meter with correct time unit factor (seconds, minutes, or hours).
tot CF	Totalizer Conversion Factor	Sets multiplier factor to display total in any engineering unit.
totAL	Total	Sets total decimal point, or it indicates set point was assigned to total.
Y or n	Yes or No	Sets selection or de-selection of various functions.

SETUP AND PROGRAMMING

Overview

Setting up and programming the meter involves three basic steps:

1. Jumper Configuration (Page 19)
 - a. Input selection and lockout jumpers
 - b. Relay acknowledge enable
 - c. Fail-safe operation of relays
2. Connections (Page 20)
 - a. Power
 - b. Input signal
 - c. Acknowledgement and reset total
 - d. Relays
 - e. 4-20 mA output
3. Programming (Page 29)
 - a. Basic meter
 - b. Rate meter
 - c. Totalizer
 - d. Batch controller
 - e. Relays
 - f. 4-20 mA output
 - g. Lockout and display selection

Programmed Parameter Settings

To simplify programming, write down the desired programming settings prior to attempting to program the meter. The **Programmed Parameter Settings** form located on page 83 provides a convenient method to record the user settings; it also provides the factory settings for most of the programmable parameters.

Jumpers and Switch Configuration

Overview

Before programming the meter, it is necessary to configure three jumper arrays and switch S1. The jumper arrays and switch S1 are used for setting the type of input signal; excitation voltage, enable relay acknowledgement (ACK), and setting relay fail-safe operation. Removing the lockout jumper enables the programming functions.

Jumper Arrays & Switch Function

Function	Label	Location	Diagram
Input Signal	JP5, JP7, S1	Main Board	Figure 1
Excitation	JP1		
Lockout	JP2		
Relay ACK Enable	JP3	Display Board	Figure 2
Fail-Safe	JP6	Display Board	Figure 2

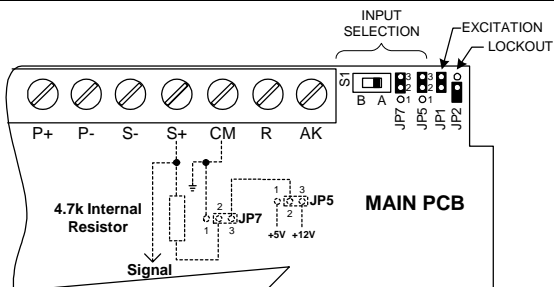

Figure 1. Input Signal Selection & Lockout

Function	JP5 (1-2)	JP5 (2-3)	JP7 (1-2)	JP7 (2-3)	Switch S1	JP1	JP2
± 125 mV to ± 12 V Pulse Input	Off	On	Off	On	B		
0-5 V Pulse Input	On	Off	Off	On	A		
0-24 V Pulse Input	Off	On	Off	On	A		
NPN Input	Off	On	Off	On	A		
PNP Input	Off	On	On	Off	A		
12 VDC (P+, P-) Excitation						On	
24 VDC (P+, P-) Excitation						Off	
Lockout							On

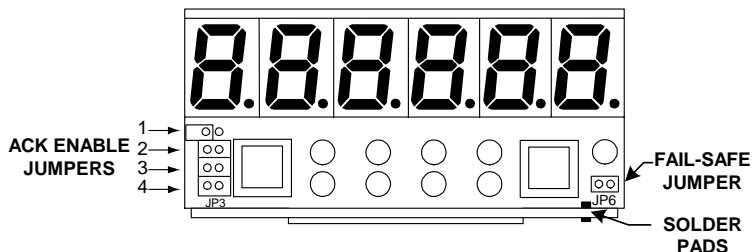

Figure 2. Relay Acknowledge Enable & Fail-Safe Jumper

Relay Acknowledge Enable (Display Board)

Jumper JP3 Position	Function
1	Enable relay 1 manual reset
2	Enable relay 2 manual reset
3	Enable relay 3 manual reset
4	Enable relay 4 manual reset

Fail-Safe Operation of Relays (Display Board)

Jumper JP6 Position	Function
On	Apply fail-safe function to the relays
Off	Disable fail-safe function to the relays

Note:

Meters manufactured prior to 3/17/04 do not have a fail-safe jumper on the Display Board and require the removal of the Options Board from the case in order to disable the fail-safe operation. Refer to page 81 for option card removal.

Connections

Overview

The following connections are made to removable screw terminal connectors supplied with each meter:

- Power
- Input Signal
- Acknowledgement and Reset Total
- Relays
- 4-20 mA Output



Disconnect power to the meter prior to performing the following procedures.

Wiring Instructions

Refer to Figure 3 for connectors' location.

1. All field connections to be made with insulated copper wire, either solid or stranded. Tighten all screw terminals to 4.5 in-lb (0.5 Nm). Strip length = ¼ in (7 mm). **DO NOT** pre-treat wire with solder.
2. **Terminals L(V+), L(V-) on Main Board connector and terminals 1-6 on J2-J3, Options Board** : Use AWG #12-18 wire, 600 volt, 60°C. Connect only one wire to each terminal.
3. **Terminals AK, R, CM, S+, S-, P-, P+ on Main Board and terminals +, - on Options Board**: Use AWG #12-22 wire, 150 volt, 60°C. If using AWG #20 or smaller wire, up to two wires may be connected to each terminal. If using AWG #18 or larger wire, only one wire may be connected to each terminal.

Terminals Designation

Terminal	Description
L, L	AC input power
V+, V-	DC input power
P+, P-	12 or 24 VDC output power
S+, S-	Input signal
CM	Common (return) for AK and R

Terminal	Description
R	External total reset
AK	External relay acknowledge
+, -	4-20 mA output
1-6	Relays 1-4

AC Power and Signal Connector

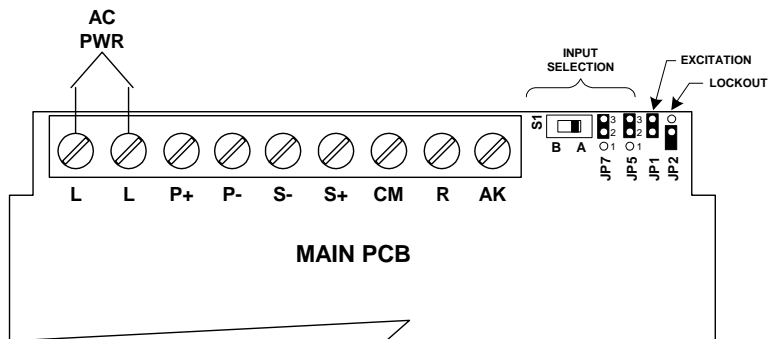

Figure 3. AC Power & Signal Connector Diagram

DC Model Power and Signal Connector

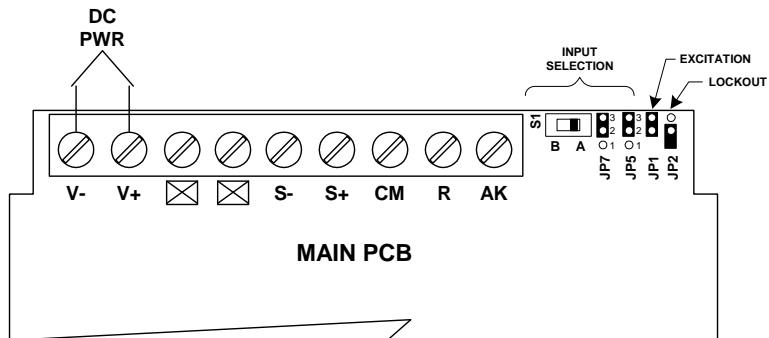

Figure 4. DC Power & Signal Connector Diagram

Power Connections



Disconnect power to the meter before making any connections.



Connecting 230 VAC to meters designed for 115 VAC will result in damage to the instrument as well as endanger personnel.



Do not connect power or earth ground to any unused or CM terminals.

Connect power to terminals L(V-) and L(V+) on Main Board screw terminal connector, located at the rear of the instrument.

Notice:

- Primary voltages must not be accessible to the user.
- Primary wires must be installed in accordance to the applicable standards.
- Keep the primary wires separated from signal cables.

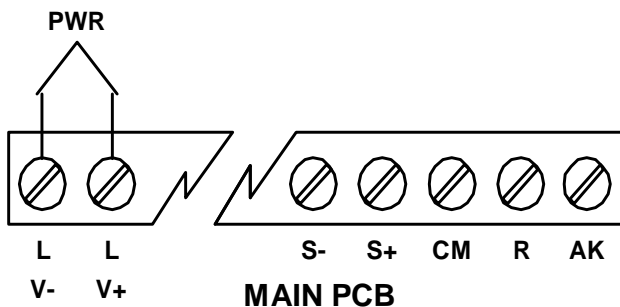

Figure 5. Input Power Connections

Signal Connections

Signal connections are made to the connector on the Main Board. This connector also includes connections for power, acknowledgement, reset total, and common. Refer to Figure 3 for location.

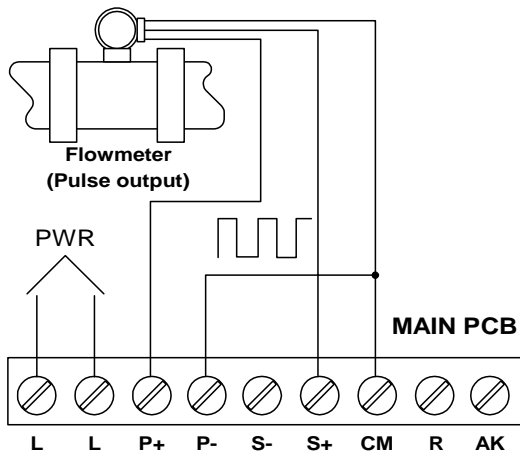

Figure 6. Flowmeter Powered by Internal Power Supply

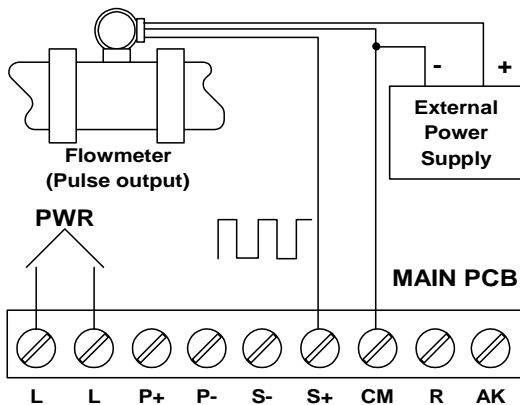

Figure 7. Flowmeter Powered by External Supply

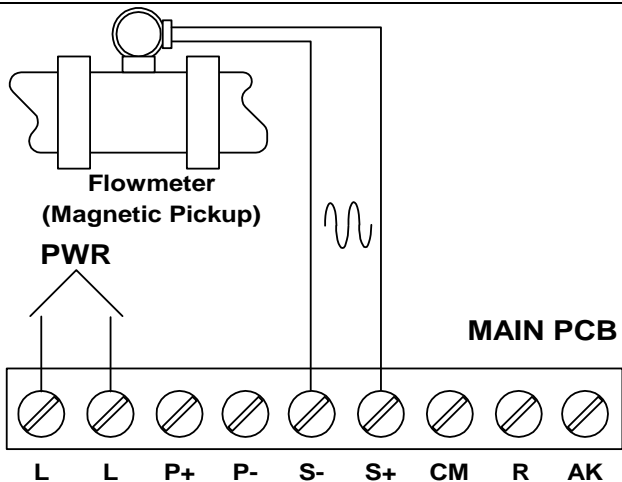

Figure 8. Self-Powered Magnetic Pickup Flowmeter

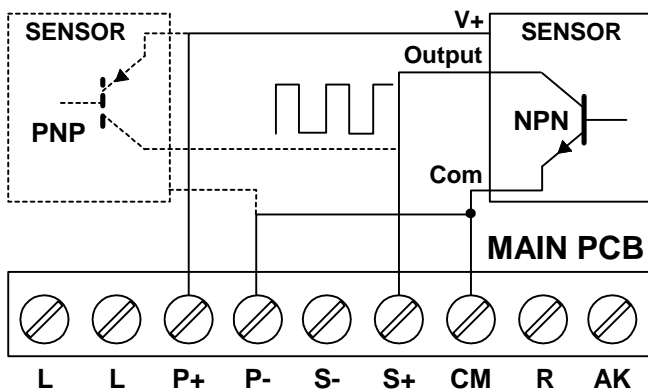

Figure 9. Open Collector Transistor Output

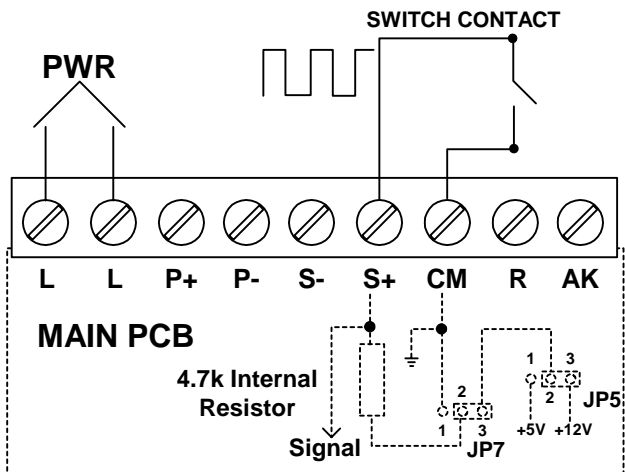

Figure 10. Switch Contact Closure

Acknowledgement, Reset Total Connections

Acknowledgement and reset total terminals provide a convenient method to remotely access the following functions:

Terminal	Function
AK	Acknowledges or resets relays, exit menu scroll, diagnostic and calibration.
R	Resets total to zero.

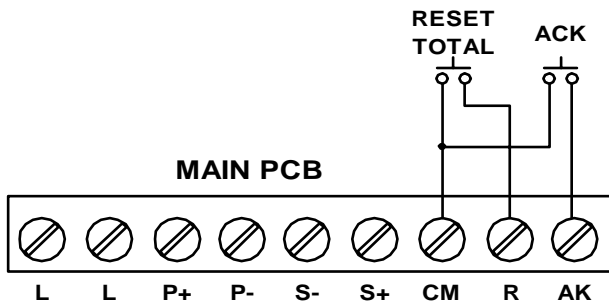

Figure 11. External Control Connections

Optional Relays and 4-20 mA Output Terminals

Depending on the model number, the Options Board may contain 2 or 4 relays and an isolated 4-20 mA output transmitter. Relay connections are made to removable screw terminal connectors located at J2 and J3 on the Options Board. Connections for the isolated 4-20 mA output option are made to J1 on the Options Board.

Function	Screw Terminal Connector	Pin Number
Transmitter +	J1	1
Transmitter -	J1	2
Relay 1 Common	J2	1
Relay 1 NC	J2	2
Relay 1 NO	J2	3
Relay 2 Common	J2	4
Relay 2 NC	J2	5
Relay 2 NO	J2	6
Relay 3 Common	J3	1
Relay 3 NC	J3	2
Relay 3 NO	J3	3
Relay 4 Common	J3	4
Relay 4 NC	J3	5
Relay 4 NO	J3	6

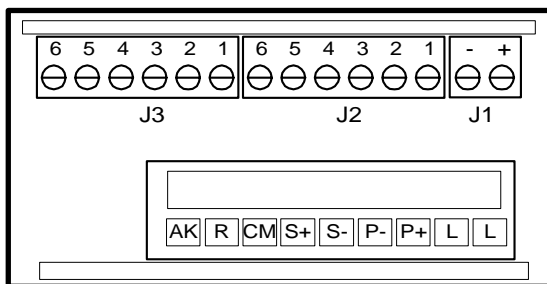

Figure 12. Connectors Location - Rear View of Meter

Isolated 4-20 mA Output Option Connections

The meter can be equipped with an isolated 4-20 mA output signal option that can be programmed to produce a 4-20 mA output for virtually any rate display with at least a 501 count span.

The following diagrams illustrate the 4-20 mA output signal being powered from the meter's internal power supply and by an external power supply.

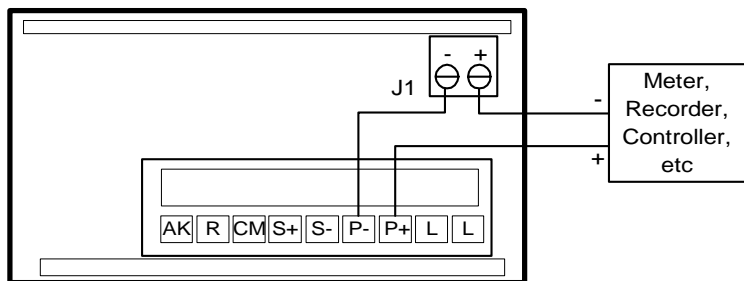

Figure 13. Output Loop Powered by Meter

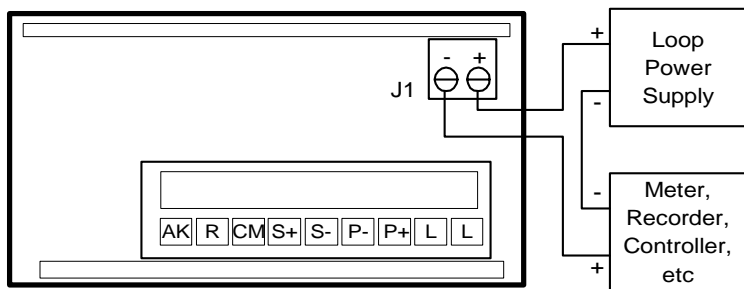

Figure 14. Output Loop Powered from External Supply



If the output loop is powered by an external supply, the loop power supply must be turned on before the meter is turned on. Otherwise, the output loop signal may be incorrect.

Programming

Overview

The meter is programmed using the **ENTER** button, three jumper arrays, and switch S1. The **ENTER** button is used to calibrate the meter, program various totalizer functions, and to set alarm trip and reset points. The jumper arrays are used for programming the input signal, lockout, relay acknowledge enable, and relay fail-safe operation. This section of the manual deals with programming the following aspects of the meter:

- Basic Meter Programming
- Rate Meter Setup
- Totalizer Programming
- Set Point Setup and Programming
- Isolated 4-20 mA Output Programming (output)
- Lockout and Display Selection Programming

General Programming Description

All programming is performed using the **ENTER** button. To set up a function there are sequential steps that have to be performed. As each step progresses, either a single digit or the entire display will flash. The flashing digit, or flashing display, will be looking for acknowledgement if it is the desired digit or display. Pressing the **ENTER** button will accept the value. If the flashing display or digit is not the one desired, wait and the value will change.

Each digit will flash for 3 seconds before it starts to change, when it is accepted the next digit will flash for 3 seconds. This procedure will continue until the **ENTER** button is pressed while the desired option is flashing. As the programming progresses there will be times when a decision has to be made, an example is yes or no (**Y** or **n**).

ENTER and ACK Functionality

The **ENTER** button is used to program the meter for various functions.

The **ACK** button is used to acknowledge the relays during operation and to quit main menu scroll during programming, diagnostic menu, and calibration.

Five Basic Digit/Display Setting Instructions

1. If flashing display is OK, press **ENTER** to accept it, before display stops flashing.
2. If flashing display is not OK, (or if **ENTER** was not pressed in time to accept it), wait for the first digit to flash.
3. If a flashing digit is OK, press **ENTER** to accept it, before it starts to scroll.
4. If a flashing digit is not OK, (or if **ENTER** was not pressed in time to accept it) wait for digit to scroll, and press **ENTER** when OK.
5. Digits will scroll until **ENTER** is pressed. When a digit is accepted by pressing **ENTER**, next digit flashes.

The display will scroll through the following main menu functions in the order shown:

Display	Type of Function
<i>dSPY r</i> or <i>dSPY t</i>	Displays rate or display total.
<i>rSEt t</i>	Resets total to zero.
<i>dSPY P</i>	Displays and hold peak reading.
<i>FActoR</i> , <i>CAL Ib</i> or <i>SCALE</i>	Calibrates meter after setting it for K-factor, external or internal calibration.
<i>CutoFF</i>	Sets low-flow cutoff point.
<i>t bASE</i>	Sets time base.
<i>tot CF</i>	Sets totalizer conversion factor.
<i>dECPt</i>	Sets rate and total decimal point.
<i>SEtP</i>	Sets set points for rate or total, latching or non-latching relays.
<i>SEtPtS</i>	Sets alarms set/reset points and batch presets.
<i>outPut</i>	Sets 4-20 mA output values, if option is installed.
<i>dSPLAY</i>	Includes or excludes menu titles from scroll.
<i>d IAS</i>	Displays parameter settings one at a time for diagnostic purposes.

To quit main menu scroll, diagnostic menu, calibration, or scaling press **ACK** while displaying menu item or while display is flashing input n or display n, where n is the input or display number.

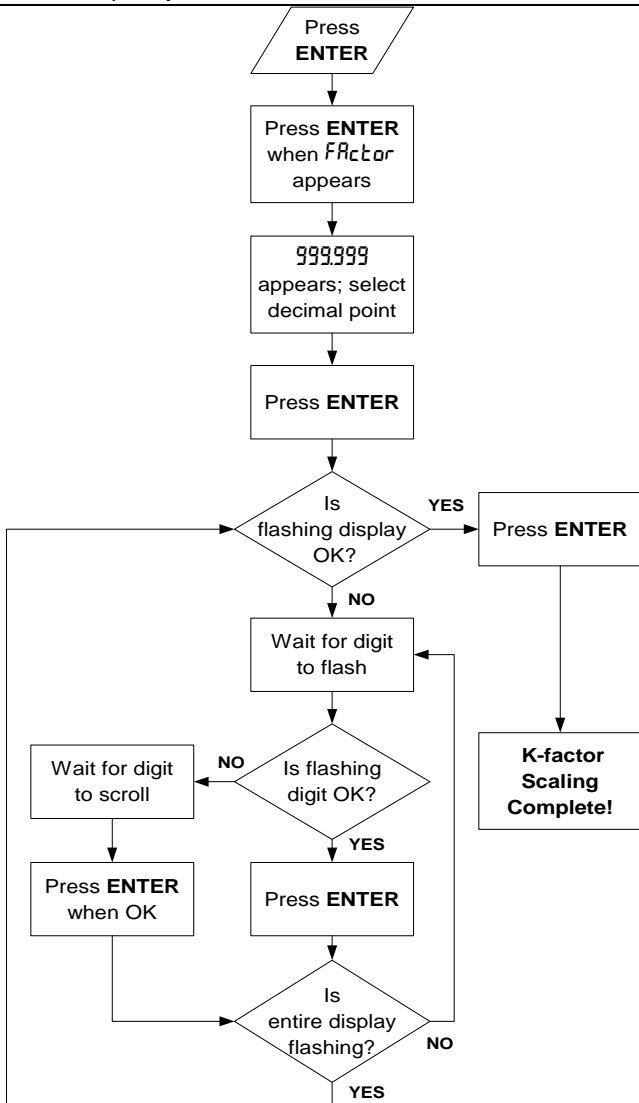
**Figure 15. K-Factor Scaling Flowchart**

Basic Meter Programming

Overview

The meter is programmed using the **ENTER** button, three jumper arrays, and switch S1. The **ENTER** button is used to calibrate the meter, program various totalizer functions, and to set alarm trip and reset points. The jumper arrays are used for programming the input signal, lockout, relay acknowledge enable, and relay fail-safe operation.

There are three steps for programming the basic meter functions:

1. Select Input Signal
2. Select K-Factor, Calibration, or Scaling Method
3. Program K-Factor, Calibrate or Scale the Meter

To disable the relays' fail-safe operation it is necessary to remove the snap-off cover from the enclosure and remove the fail-safe jumper JP6 on the Display Board, see Figure 2 on page 20.

Note To simplify programming, write down the desired programming settings prior to attempting to program the meter. The **Programmed Parameter Settings** form located on page 83 provides a convenient method to record the user settings; it also provides the factory settings for most of the programmable parameters.

Quit Menu Scroll, Diagnostic, and Calibration

To quit main menu scroll, diagnostic menu, calibration, or scaling press **ACK** while displaying menu item or while display is flashing input n or display n, where n is the input or display number.

Minimum Input Span (*Error Message*)

The calibration input signals must be within the range of the meter and input 2 must be greater than input 1. However, the display for input 2 does not have to be greater than the desired display for input 1.

If input 1 signal and input 2 signal are within 3 Hz, an **Error** message will appear and the display will return to the current input to be calibrated. To terminate calibration process press **ACK** button.

Select Input Signal

The meter can be programmed to accept all the common pulse inputs and contact closure signals using jumper JP5, JP7, and S1 switch located on the Main Board, at the rear of the instrument. Jumper JP1 sets the excitation voltage to 12 VDC or 24 VDC.

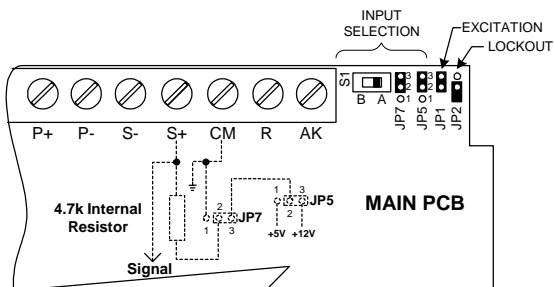

Figure 16. Input Signal Selection & Lockout

Function	JP5 (1-2)	JP5 (2-3)	JP7 (1-2)	JP7 (2-3)	Switch S1	JP1	JP2
± 125 mV to ± 12 V Pulse Input	Off	On	Off	On	B		
0-5 V Pulse Input	On	Off	Off	On	A		
0-24 V Pulse Input	Off	On	Off	On	A		
NPN Input	Off	On	Off	On	A		
PNP Input	Off	On	On	Off	A		
12 VDC (P+, P-) Excitation						On	
24 VDC (P+, P-) Excitation						Off	
Lockout							On

The meter can also be programmed to restrict personnel from making changes to the meter's programming by installing a jumper over JP2 pins on Main Board. For a complete description of the **Lockout and Display Selection Programming** features, see page 61.

Select K-Factor, Calibration, or Scaling Method

The meter may be scaled using the K-factor function, calibrated using an external signal source such as a calibrator, or scaled using the internal source with the **I-CAL** (internal calibration) feature. With **I-CAL**, a frequency input signal can be scaled for any display range without applying a signal.









To select Calibration Method, apply power with **ENTER** button pressed.

1. When display stops flashing, release **ENTER** button. Display alternates between **PL5** and **FACTOR**.
2. To select multi-point calibration/scaling, press **ENTER** when **PL5** is displayed.
3. To calibrate meter with an external source, such as a calibrator, press **ENTER** when **E-CAL** appears.
4. To scale meter with internal source, press **ENTER** when **I-CAL** appears.

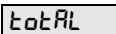
After the calibration method has been selected, the meter returns to reading mode. To perform K-factor scaling, calibration, or scaling follow the corresponding procedure on pages 36-39.

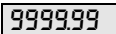
Set Rate and Total Decimal Point

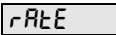

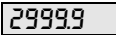
The totalizer decimal point may be set independently of the rate decimal point. For instance, it is possible to have a rate decimal point set at 2999.9 and a totalizer decimal point set at 999.999.

<p style="text-align: center;">Set decimal point</p> <p>Press ENTER when the dECPt (decimal point) function appears. The display moves to the total and rate decimal point functions. If ENTER is not pressed within 3 seconds the display moves on to the next function to be programmed.</p>		
<p style="text-align: center;">Set totalizer decimal point</p> <p>Press ENTER when the totAL (totalizer decimal point) function appears.</p>		
<p>Select the desired decimal point location by pressing ENTER when the decimal point is in the desired location. If no decimal point is required press ENTER when the decimal point is not shown. The display moves to the rate decimal point function.</p>	 final 	
<p style="text-align: center;">Set rate decimal point</p> <p>Press ENTER when the rAtE (rate decimal point) function appears.</p>		
<p>The decimal point will begin to scroll, and a zero will be displayed for the sixth digit. Select decimal point location or extra zero by pressing ENTER when decimal point is in the required location or extra zero is displayed. If no decimal point is required, press ENTER when the decimal point is not shown.</p>	 final 	



Scale or Calibrate the Meter

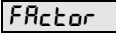
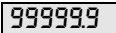
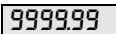
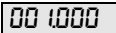



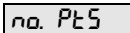
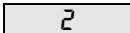
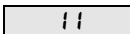

The meter may be scaled using the K-factor function, calibrated using an external signal source such as a calibrator, or scaled using the internal source with the **I-CAL** (internal calibration) feature. With **I-CAL**, a frequency input signal can be scaled for any display range without applying a signal.

Scale Using K-Factor (**FRACTOR**)

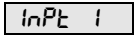
<p>Set K-factor Press ENTER when the FRACTOR (K-factor) function appears. The display moves to setting the K-factor decimal point.</p>		
<p>Select the desired decimal point location by pressing ENTER when the decimal point is in the desired location. If no decimal point is required press ENTER when the decimal point is not shown. The display moves to setting the K-factor value.</p>	 final 	
<p>Set K-factor value The entire display will flash for three seconds. For instructions, see Five Basic Digit/Display Setting Instructions, page 30.</p>	 final 	

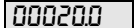
Scale Using Internal Calibration (**I-CAL**)

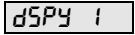
<p>Note To simplify programming, write down the desired programming settings prior to attempting to program the meter. The Programmed Parameter Settings form located on page 83 provides a convenient method to record the user settings; it also provides the factory settings for most of the programmable parameters.</p>		
<p>Press ENTER, then press it again when the SCALE (scale) function appears.</p>		
<p>Select the number of calibration points If ENTER is not pressed when no. PLS is displayed, the number of points will default to whatever was selected previously. To program the number of calibration points, press ENTER while no. PLS is flashing. When desired number of points is displayed, press ENTER.</p>	 then  ... 	

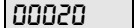





<p>Set the first calibration point</p> <p>INPt 1 (input 1) flashes indicating that the meter is ready to be programmed for the input corresponding to the first calibration point. Press ENTER.</p>		
<p>Set the input for the first calibration point</p> <p>The entire display will flash for three seconds. For instructions, see Five Basic Digit/Display Setting Instructions, page 30.</p>		 final input 1 
<p>Set display for the first calibration point</p> <p>dSPY 1 (display 1) flashes indicating that the meter is ready to be programmed for the display corresponding to the first calibration point. Press ENTER.</p>		
<p>Program the display for dSPY 1 (display 1) as described above when the input for the first calibration point was programmed.</p>		 final display 1 

Calibration Error (*Error*)

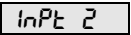



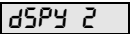



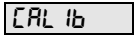
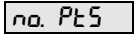
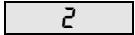
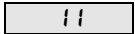

A meter display of **Error** during calibration indicates that the calibration process was not successful. The meter should be recalibrated.

The **Error** message will appear if input 1 signal and input 2 signal are too close together. Refer to **Minimum Input Span (Error Message)**, page 32.

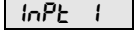
The **Error** message will appear if input 1 signal is inadvertently also applied for input 2 calibration, or **ENTER** is pressed before applying input 2.

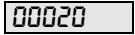
<p>Set the second calibration point</p> <p>INPt 2 (input 2) flashes indicating that the meter is ready to be programmed for the input corresponding to the second calibration point. Press ENTER.</p>		
<p>Set the input for the second calibration point</p> <p>Program the display for INPt 2 (input 2) as described above when the input for the first calibration point was programmed.</p>		 then 
<p>Set display for the second calibration point</p> <p>dSPY 2 (display 2) flashes indicating that the meter is ready to be programmed for the display corresponding to the second calibration point. Press ENTER.</p>		
<p>Program the display for dSPY 2 (display 2) as described above when the input for the first calibration point was programmed.</p>		 final display 2 
<p>Set the display for the remaining calibration points, if selected. Decimal point is set up under decimal point menu (dELPt).</p>		

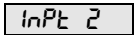
Calibrate Using External Calibration (E-CAL)

Note	To simplify programming, write down the desired programming settings prior to attempting to program the meter. The Programmed Parameter Settings form located on page 83 provides a convenient method to record the user settings; it also provides the factory settings for most of the programmable parameters.
Press ENTER , then press it again when the CAL Ib (calibrate) function appears.	  
<p style="text-align: center;">Select the number of calibration points</p> <p>If ENTER is not pressed when no. Pt5 is displayed, the number of points will default to whatever was selected previously. To program the number of calibration points, press ENTER while no. Pt5 is flashing. When desired number of points is displayed, press ENTER.</p>	 then  ... 
<p style="text-align: center;">Apply the signal for the first calibration point</p> <p>InPt 1 (input 1) flashes indicating that the meter is ready to accept a signal for the first calibration point. Apply the desired signal and press ENTER.</p>	  
<p style="text-align: center;">Set the display for the first calibration point</p> <p>The entire display will flash for three seconds. Program display value per Five Basic Digit/Display Setting Instructions, page 30.</p>	 final display 1 
<p style="text-align: center;">Apply signal for the second calibration point</p> <p>InPt 2 (input 2) flashes indicating that the meter is ready to accept a signal for the second calibration point. Apply the desired signal and press ENTER.</p>	  
<p style="text-align: center;">Set the display for the second calibration point</p> <p>Program the display as described above when the display for the first calibration point was programmed.</p>	 final display 2 
Set the display for the remaining calibration points, if selected.	

Gate Function (GATE)

The gate function is used for displaying slow pulse rates. In the previous version of this meter, the minimum rate that could be displayed was 0.33 pulse/sec. Using the programmable gate, the meter is able to display pulse rates as slow as 1 pulse every 99 seconds (0.0101 pulse/sec). The gate function can also be used to obtain a steady display reading with a fluctuating input signal.

The gate function (GATE) has been added to **BASE** menu. After time base is selected, GATE will appear. If there is no need to change gate setting, let it time out without pressing **ENTER**. There are two settings for the GATE, low gate (LO) and high gate (HI).



Low Gate (LO)

For most applications, low gate setting should be left at 1.0 second. Increase low gate setting to obtain a steadier rate display. The rate display will update in accordance with the low gate setting, for example if low gate is set at 10.0, the display will update every 10 seconds; changes in rate between updates will not be reflected until next display update.

High Gate (HI)

Set the high gate value to correspond to the highest expected pulse width (lowest pulse rate). For instance if the meter must display a rate when there is 1 pulse coming into the meter every 10 seconds, set the high gate to 11.0 seconds. When the signal is removed from the meter, the display will show the last reading for 11 seconds; then it will read zero.

Programming the Gate (GATE)

<p>Press ENTER, then press it again when the BASE (time base) function appears. Select appropriate time base, after time base has been selected GATE appears. Press ENTER to set gate values.</p>		<p>BASE</p> <p>then</p> <p>SEC</p> <p>then</p> <p>GATE</p>
<p>Low gate function and setting will be displayed. Press ENTER to accept low gate value. Display will show high gate function and setting, change value as required.</p> <p>After gate values have been programmed, the meter moves on to the next function to be programmed.</p>		<p>LO</p> <p>then</p> <p>0000 10</p> <p>then</p> <p>HI</p> <p>then</p> <p>000030</p>

Contact De-Bounce Filter (F ILtEr)

The filter function (**F ILtEr**) can be used for applications where the meter is set up to count pulses generated by switch contacts. The filter value can be set anywhere between 2 and 50, the higher the value, the greater the filtering.

To access this feature, power up the meter with **ACK** button pressed. When display comes on release **ACK** button, display will alternate between **HI SPd** (high speed) and **LO SPd** (low speed), press **ENTER** when **LO SPd** is displayed to enable filter function. The filter function (**F ILtEr**) appears at the end of the main menu scroll with low speed filter selected. Program the filter value, so that there are no extra counts when contact closure is completed.

Gate and Filter Settings

Contact De-Bounce Filter			Slow Pulse Rate			
Filter Setting	Speed Setting	Max Freq Hz	Low Gate**	High Gate	Min Pulse Rate (p/s)	Min Freq* Hz
2	LO	950	1	3.1	1/3	0.3333
4	LO	450	1	10.1	1/10	0.1000
10	LO	200	1	30.1	1/30	0.0333
25	LO	75	1	60.1	1/60	0.0167
50	LO	40	1	90.1	1/90	0.0111
N/A	HI	30,000	1	99.1	1/99	0.0101
* Minimum frequency is dependent on high gate setting.						
** Low gate setting can be used to stabilize display reading with fluctuating signal.						
NOTE: (Input frequency) x (Low gate) must be < 65,000. Otherwise, display goes overrange.						



Rate Meter Setup

Overview

The meter can be used to display flow rate. In addition to the scaling and calibration procedures described above, the only setup required for this type of application is setting the meter to display rate, and programming the low-flow cutoff if required.

Set Display to Rate (*dSPY r*)

The user may select either rate or total to be set as the default displayed reading. When displaying rate, the rate LED indicator will be illuminated.

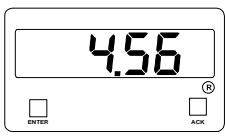



<p>To change the display from reading total to rate</p> <p>Press ENTER to begin scrolling through the functions.</p>	
<p>When <i>dSPY r</i> (display rate) appears, press ENTER.</p>	
<p>The meter now displays rate and the green R LED on the right side is illuminated.</p>	

Low-Flow Cutoff Programming (Cutoff)

The low-flow cutoff feature allows the meter to be programmed so that any input below the cutoff point is always displayed as zero on the rate display.

In multi-point calibration/scaling, the total is based on the rate display; so, inputs below the low-flow cutoff value will not affect the totalizer.

In K-factor scaling, the totalizer ignores the low-flow cutoff; the totalizer counts every incoming pulse regardless of the rate display.

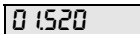
<p>To set the low-flow cutoff point Cutoff Press ENTER, then press it again when Cutoff (low-flow cutoff) appears.</p>		
<p>The entire display will flash for three seconds. Program low-flow cutoff value per Five Basic Digit/Display Setting Instructions, page 30. NOTE: To disable low-flow cutoff, reprogram the value to zero.</p>	 then  then  final 	

Totalizer Programming



Overview

The meter can also be used to display total flow. There are five functions to be programmed to allow the meter to act as a flow totalizer:

1. Set display to total
2. Set rate time base
3. Set totalizer conversion factor
4. Set totalizer decimal point
5. Set alternating display (if needed)

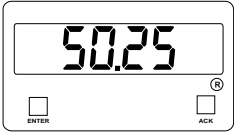

Set Display for Total (*dSPY t*)

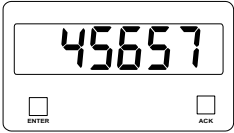
The user may select either rate or total to be set as the default displayed reading. When displaying rate, the green rate LED indicator will be illuminated.

<p>To change the display from reading rate to total</p> <p>The meter is now displaying rate, as indicated by the green LED illuminated on the right side of the display. Press ENTER to begin scrolling through the functions.</p>	
<p>When <i>dSPY t</i> (display total) appears, press ENTER.</p>	
<p>The meter now displays total.</p>	

Set Rate Time Base (t bASE)

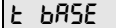
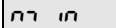
To act as a totalizer, the meter must be programmed with the same time base as the flowmeter. The time base is the time units in which the rate is displayed. For example, if the rate is in gallons per hour then the time base must be set to *Hour*.

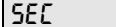



<p>To set the time base t bASE</p> <p>Press ENTER, then press it again when the t bASE (time base) function appears.</p>		
<p>The different units of time will scroll: minute, hour, second. Press ENTER when the required unit is displayed.</p> <p>The display moves to setting the gate function. If ENTER is not pressed within 3 seconds, the display moves to the next function to be programmed. Refer to page 40.</p>	 or  or 	

Set Totalizer Conversion Factor (t b CF)

The totalizer conversion factor is a number that is multiplied by the rate to compute the total. For example, if the rate display is gallons per hour and total is desired in barrels, (1 gallon = .02381 barrels) a total conversion factor of .02381 should be used. If the rate display is gallons per hour and total is desired in gallons, a factor of 1 should be used.

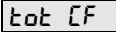
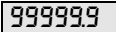

The factor has a selectable decimal point. Because the decimal point is mathematically significant, values such as 1.0000, 1.0, and 1 produce identical results. However, values such as 1.1111, 1.1, and 1 produce different results. The decimal point should be set so as to produce the best resolution for the application. The maximum value for the totalizer conversion factor depends upon the decimal point selection.

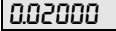
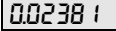
Number of Decimal Places	Maximum Conversion Factor
0	59999
1	5999.9
2	599.99
3	59.999
4	5.9999
5	0.59999

<p>Set totalizer conversion factor</p> <p>Press ENTER, then press ENTER again when the tot CF (totalizer conversion factor) function appears.</p>		
<p>Set the totalizer conversion factor decimal point</p> <p>Immediately after tot CF is selected, the display will show six numbers. After three seconds, the decimal point will begin to scroll. Select the desired decimal point location by pressing ENTER when the decimal point is in the desired location. If no decimal point is required press ENTER when the decimal point is not shown.</p>	<p></p> <p>then</p> <p></p> <p>final</p> <p></p>	
<p>Set the total conversion factor value</p> <p>Once the decimal point has been selected, the entire display will flash for three seconds. For instructions, see Five Basic Digit/Display Setting Instructions, page 30.</p>	<p></p> <p>then</p> <p></p> <p>final</p> <p></p>	





Set Totalizer Decimal Point

The totalizer decimal point may be set independently of the rate decimal point. For instance, it is possible to have a rate decimal point set at 2999.9 and a totalizer decimal point set at 999.999. Rate decimal point setting instructions are also explained below, ignore if the rate decimal point has been set up already.

<p style="text-align: center;">Set decimal point</p> <p>Press ENTER when the dECPt (decimal point) function appears. The display moves to the total and rate decimal point functions. If ENTER is not pressed within 3 seconds the display moves on to the next function to be programmed.</p>	<p style="text-align: center;">ENTER</p> 	<p style="text-align: center;">dECPt</p>
<p style="text-align: center;">Set totalizer decimal point</p> <p>Press ENTER when the totAL (totalizer decimal point) function appears.</p>	<p style="text-align: center;">ENTER</p> 	<p style="text-align: center;">totAL</p>
<p>Select the desired decimal point location by pressing ENTER when the decimal point is in the desired location. If no decimal point is required press ENTER when the decimal point is not shown. The display moves to the rate decimal point function.</p>	<p style="text-align: center;">99999.9</p> <p style="text-align: center;">final</p> <p style="text-align: center;">9999.99</p>	
<p style="text-align: center;">Set rate decimal point</p> <p>Press ENTER when the rAtE (rate decimal point) function appears.</p>	<p style="text-align: center;">ENTER</p> 	<p style="text-align: center;">rAtE</p>
<p>The decimal point will begin to scroll, and a zero will be displayed for the sixth digit. Select decimal point location or extra zero by pressing ENTER when decimal point is in the required location or extra zero is displayed. If no decimal point is required, press ENTER when the decimal point is not shown.</p>	<p style="text-align: center;">299.99</p> <p style="text-align: center;">final</p> <p style="text-align: center;">2999.9</p>	

Set Alternating Total/Rate Display

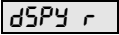
The display may be programmed to automatically toggle between rate and total every ten seconds. The alternating display is set up by selecting **n** (no) for both, **dSPY r** (display rate) and **dSPY t** (display total) on the **dSPLAY** (display) menu.

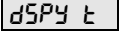
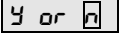
<p>Set alternating total/rate display</p> <p>Press ENTER, then press it again when dSPLAY (display) function appears.</p>		
<p>Press ENTER when dSPY r (display rate) appears</p>		
<p>y or n (yes or no) will flash alternately. Press ENTER when n (no) appears.</p>		
<p>Press ENTER when dSPY t (display total) appears</p>		
<p>y or n (yes or no) will flash alternately. Press ENTER when n appears.</p>		
<p>NOTE: Selections made through the display menu can be made with or without the lockout jumper installed, but only become active when the lockout jumper is installed.</p>		

*This completes the calibration and
setup of the Basic Meter and
Totalizer*

Parameter Combinations Resulting in Error 1 Message

Certain extreme combinations of parameter selections may exceed the totalizer range of the meter. If this occurs, the meter will momentarily display **Error 1** immediately after a programming operation. Steps to correct this situation are:

Increase the number of decimal places in rate or totalizer conversion factor, or

Decrease the number of decimal places in total.

Set Point Setup and Programming

Overview

The meter is available with 4 alarm points and corresponding front panel status LEDs as a standard feature. The front panel LEDs are useful for alarm applications that require visual notification only. For applications that require relay contacts, such as driving external alarm devices or batch controlling, the meter can be equipped with either two or four relays. Any of these relays may be assigned to rate or total.

Programming the relays involves four steps:

1. Setting the relay manual reset (ACK enable) jumpers:
These jumpers (JP3) are located on the Display Board and determine if a relay can be reset manually.
2. Setting the fail-safe jumper (JP6):
Fail-safe mode (default): In the alarm condition, the normally closed (NC) contacts are connected to the common (C) contacts of the relays. The fail-safe operation can be disabled, by removing jumper JP6 located on the Display Board.
3. Setting set point functions using setup (**SEtUP**) menu:
 - a. Selecting set points for rate or total.
 - b. Selecting latching or non-latching relay action for rate set points.
 - c. Selecting preset offset for total set points.
 - d. Selecting internal or external (**I or E**) total reset for batch control applications.
 - e. Programming delay on release between 1 and 999 seconds if internal total reset (**I**) has been selected.
 - f. Selecting pump alternation control feature for non-latching relays.
4. Programming set, reset, preset, offset, and delay values using the set points (**SEtPt5**) menu:
 - a. Set and reset points for alarms (set points) assigned to rate (thus determining high or low alarm status and deadband).
 - b. Preset values for set points assigned to total.
 - c. Preset offset values for set points assigned to total with offset selected.

Set Relays for Manual or Automatic Reset

Jumper array JP3 located on the Display Board is used to program the relays so they can be reset manually. This jumper array, in combination with **SEtUP** functions of latching or non-latching for rate and internal or external total reset, provide multiple relay reset modes:

Relays Assigned to Total		
Type of reset	JP3 Jumper Position	SEtUP Menu
Automatic after delay elapses	N/A	Internal (I)
Automatic when total resets to zero + manual reset at any time	On	External (E)

Relays Assigned to Rate		
Type of reset	JP3 Jumper Position	SEtUP Menu
Automatic only after passing the reset point	Off	Non-latching
Automatic + manual at any time	On	Non-latching
Manual only at any time	On	Latching
Manual only after passing the reset point	Off	Latching

Set Relays for Fail-Safe Operation

In the fail-safe mode, the relay coils are *energized* and the Normally Open (NO) contacts are connected to the Common (C) contacts under normal operation. During an alarm condition the relay coils are *de-energized* and the Normally Closed (NC) contacts are connected to the Common (C) contacts. During a power failure the relay contacts reflect an alarm condition.

Removing jumper JP6 disables the fail-safe operation. Jumper JP6 is located on the Display Board, see Figure 2 on page 20. If fail-safe mode is disabled, the operation of the relay contacts is opposite to the one described in the previous paragraph.

Assigning Set Points to Rate or Total (SEtUP)

The optional relays can be assigned to respond to the rate or the accumulated total using the **SEtUP** function. Rate relays may be set for latching or non-latching operation. Total relays may be programmed for manual or automatic reset after a programmable delay on release of between 1 and 999 seconds has elapsed. Delay on release is available when internal total reset is selected. The internal total reset function is applied to the highest programmed preset value.

The **SEtUP** menu is used to program the following:

1. Selecting a set point for rate or total

Any set point can be set up so it responds to the rate or total display.

2. Latching or non-latching relay action for rate set points

Any rate set point can be set up so it functions as a latching or non-latching relay. In latching mode, the relay must be reset via the front panel ACK button or an external switch wired across terminals AK and CM at connector on the Main Board.

3. Internal or external total reset effect on total relays

If internal total reset is selected, the total resets to zero when the highest preset value is reached. All relays assigned to total will automatically reset after the delay on release elapses, allowing a new batch to begin.

If external total reset is selected, relays must be reset manually. total relays also reset when total is reset to zero.

4. Preset offset for total set points



Relays assigned to total can be programmed to trip at any point below the next relay's preset value. If preset offset mode is selected the corresponding relay will always trip at a programmed offset value before the next relay trips. When an offset value is being programmed, the corresponding status LED flashes.





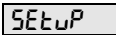
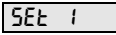
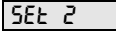
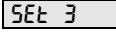
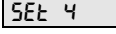
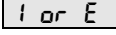

Example: Set point 1 and 2 are set up for total, with offset selected (under set point 2). If the preset offset is set at 10, (during Set points programming for set point 1), then relay 1 will trip 10 counts before relay 2.

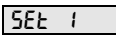
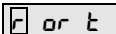
5. Program delay on release between 1 and 999 seconds if internal total reset has been selected.

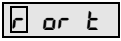
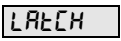
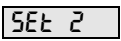
If internal total reset is selected, the total is automatically reset to zero when the highest preset is reached, then a delay will occur before all total relays reset automatically. The delay can be programmed anywhere between 1 and 999 seconds. Once the delay has started, the ACK button becomes inoperative for all total relays until the delay has elapsed.

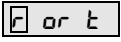
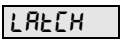
Rate or Total, Latching or Non-Latching Relays (SEtUP)

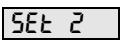

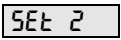
<p>Note To simplify programming, write down the desired programming settings prior to attempting to program the meter. The Programmed Parameter Settings form located on page 83 provides a convenient method to record the user settings; it also provides the factory settings for most of the programmable parameters.</p>		
<p>Press ENTER, then press ENTER again when the SEtUP (setup) function appears</p>		
<p>To set up set points</p> <p>SEt 1 (set point 1) will be displayed. Press ENTER to program set point 1 or wait and the display will move to the next set point. When SEt 4 (set point 4) is shown, the meter will exit the SEtUP (setup) menu and move to the next programming menu.</p>		 then  then  then  then 
<p>If ENTER is pressed while SEt 1 (set point 1) is shown, the display will then show r or t (rate or total) flashing alternately.</p> <p>Select the desired one by pressing ENTER when it is flashing.</p>		 then 

<p style="text-align: center;">Select rate</p> <p>After selecting r for rate, the display will show LATCH (latching). Press ENTER to program this function. If ENTER is not pressed within 3 seconds, this function will remain programmed as it was before, and the next set point will be displayed.</p>	<div style="text-align: center;"></div> <p>then</p> <div style="text-align: center;"></div> <p>then</p> <div style="text-align: center;"></div>
<p>If ENTER is pressed while the display reads LATCH, then y or n (yes or no) will flash alternately. To program this set point for latching relay, press ENTER when y is flashing. To program this set point for non-latching relay, press ENTER when n is flashing. After making the selection, setup of this set point is complete and the next set point will be displayed. After set point 4 is shown the meter will exit the SEtUP menu.</p>	<div style="text-align: center;"></div> <div style="text-align: center;"></div> <p>then</p> <div style="text-align: center;"></div> <p>then</p> <div style="text-align: center;"></div> <p>then</p> <div style="text-align: center;"></div>
<p style="text-align: center;">Select total</p> <p>After selecting t for total, the display will show SEt 2 (set point 2), press ENTER to set up set point 2 or wait and the display will move to the next set point.</p>	<div style="text-align: center;"></div> <p>then</p> <div style="text-align: center;"></div>

Programming the second set point

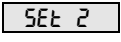
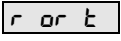
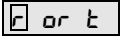
The only potential difference between the way set point 2 is programmed from the way set point 1 was programmed is if set point 1 was assigned to total. If set point 1 was assigned to total, and set point 2 is also assigned to total, then the user may select offset mode after setting set point 2 for total. The offset value will be programmed during set point 1 (**SEtPt5**) programming and it corresponds to the value at which relay 1 trips before relay 2 trips. This feature is useful for some batch control applications.

<p>If ENTER is pressed while SEt 2 (set point 2) is shown, the display will then show r or t (rate or total) flashing alternately. Select the desired one by pressing ENTER when it is flashing.</p>	<div style="text-align: center;"></div>	<div style="text-align: center;"></div> <p>then</p> <div style="text-align: center;"></div>
<p style="text-align: center;">Select rate</p> <p>After selecting r for rate, the display will show LATCH (latching). Press ENTER to program this function. If</p>	<div style="text-align: center;"></div> <p>then</p>	

<p>ENTER is not pressed within 3 seconds, this function will remain programmed as it was before, and the next set point will be displayed.</p>	<p>LATCH</p> <p>then</p> <p>SEt 3</p>
<p>If ENTER is pressed while the display reads LATCH, then y or n (yes or no) will flash alternately. To program this set point for latching relay, press ENTER when y is flashing. To program this set point for non-latching relay, press ENTER when n is flashing. After making the selection, setup of this set point is complete and the next set point will be displayed. After set point 4 is shown the meter will exit the SEtUP menu.</p>	<p>[] or t</p> <p>then</p> <p>LATCH</p> <p>then</p> <p>y or n</p> <p>then</p> <p>SEt 3</p> 
<p>Select total when the first set point was assigned to rate</p> <p>After selecting t for total, the display will show SEt 3 (set point 3), press ENTER to set up set point 3 or wait and the display will move to the next set point.</p>	<p>r or []</p> <p>then</p> <p>SEt 3</p>
<p>Select total when the first set point was assigned to total</p> <p>After selecting t for total for second set point, the display will show OFFSEt (preset offset) press ENTER to set up this function. If ENTER is not pressed within 3 seconds, this function will remain programmed as it was before, and the next set point will be displayed.</p>	<p>r or []</p> <p>then</p> <p>OFFSEt</p> <p>then</p> <p>SEt 3</p>
<p>If ENTER is pressed while the display reads OFFSEt, then y or n (yes or no) will flash alternately. To program this set point for preset offset, press ENTER when y is flashing. To program this set point without preset offset, press ENTER when n is flashing. After making the selection, setup of set point 2 is complete and the next set point will be displayed. Press ENTER to set up that set point, if not, wait until desired set point is displayed or wait for the meter to exit the SEtUP menu completely.</p>	<p>OFFSEt</p> <p>then</p> <p>y or n</p> <p>then</p> <p>SEt 3</p> 

Setup of the remaining set points

The remaining set points, set point 3 and set point 4 are set up in the same fashion as set point 2. They can be set up as rate or total set points.

Programming Internal Total Reset and Delay (dELAY)

Select internal total reset and delay

After the last set point is set up or displayed, **I or E** appears, press **ENTER**. while **I** (internal) is flashing. **dELAY** (delay) will be displayed for 3 seconds, press **ENTER** to program delay. For instructions, see **Five Basic Digit/Display Setting Instructions**, page 30.

This completes the **dELAY** (delay) programming.

then

final delay

*This completes the set points setup. The display now moves to the next programming menu (**SEtPt5**) to program the alarm set/reset and preset values. To exit main programming menu and return to reading press the **ACK** button.*

Programming Alarm Points and Presets (SEtPt5)

Overview

The set points (**SEtPt5**) menu is used to program the following functions:

1. Set and reset points for alarms assigned to rate, thus determining high or low alarm status and deadband.
2. Preset values for set points assigned to total.
3. Preset offset values for set points assigned to total with **OFFSEt** selected

Set and Reset Points for Rate Alarms

The meter can be programmed so any alarm point that is assigned to rate can be set for a high or low alarm. In addition, any rate alarm point can be programmed for 0-100% deadband. A rate alarm is programmed for a high alarm, by programming the set point at a higher value than the reset point. Conversely, a rate alarm is programmed for a low alarm, by programming the set point at a lower value than the reset point.

Example: To program an alarm for a high alarm at 500, with 100 counts of deadband program set and reset points as follows:

Set point: 500

Reset point: 400

Preset Values for Total Set Points

When a set point is assigned to total, a preset value at which the relay will trip must be programmed. Unlike set points assigned to rate, which require a set and reset point, set points assigned to total require only a preset value. When the preset value is reached, the relay transfers. The relay can be programmed to reset automatically or manually.

Preset Offset Values for Total Set Points (OFFSEt)

A preset offset value can be assigned when two adjacent set points are assigned to total and the second one has been assigned to **OFFSEt** during **SEtUP** above. The first relay of a pair will trip at a programmed preset offset value below the second relay's preset value.

Example: If the preset offset value is set at 10 then the first relay will trip at 10 counts before the second relay trips.

In the above example the relay pair combination could be 1 & 2, 2 & 3, or 3 & 4.



Programming Alarm and Preset Values (SEtPt5)

Alarm, preset, and preset offset values are programmed under the **SEtPt5** menu, one at a time, starting with set point 1. The set points are programmed according to whether they were assigned to rate or total during the **SEtUP** program. For set points assigned to rate, it is necessary to program both a set and reset points. For set points assigned to total, either a reset value or preset offset value needs to be programmed.

The 4 discrete LEDs labeled 1-4, on the display indicate which set point is being programmed.

For set points assigned to rate, there are two LEDs labeled **S** and **R** that indicate whether a set or reset point is being programmed.

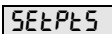
When programming set points assigned to total, only one of the 4 discrete LEDs on the display will be illuminated at a time. A flashing LED indicates that a preset offset value is being programmed, a steady-on LED indicates that a preset value is being programmed.

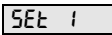
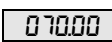
<p>Note To simplify programming, write down the desired programming settings prior to attempting to program the meter. The Programmed Parameter Settings form located on page 83 provides a convenient method to record the user settings; it also provides the factory settings for most of the programmable parameters.</p>		
<p>Press ENTER, then press ENTER again when the SEtPt5 (set points) function appears. The display will scroll through the set points, press ENTER when the desired set point is displayed to program that set point.</p>		
<p>If ENTER is pressed while SEt 1 (set point 1) is shown, the display will then show a flashing number. Follow instructions below to program set points assigned to rate and set points (presets) assigned to total.</p>		 then 

Set points assigned to rate

For set points assigned to rate during the **SEtUP** function, the alarm # (1,2,3, or 4) and the **S** (set point) LED will be illuminated. This indicates that the set point for alarm # (1, 2, 3, or 4) is being programmed.

Set the display for alarm # (1,2,3, or 4) set point

The entire display will flash for three seconds.
Program set point per **Five Basic Digit/Display Setting Instructions**, page 30.

then

final

Set the display for alarm # (1,2,3, or 4) reset point

As soon as the set point for alarm # (1,2,3, or 4) has been programmed, the meter displays the reset point for alarm # (1,2,3, or 4). This is indicated by the alarm # (1, 2, 3, or 4) LED and **R** (reset point) LED being illuminated. The reset point is programmed in the same fashion as the set point above.

Press **ENTER**, then press **ENTER** again when the **SEtPtS** (set points) function appears.

Preset values for set points assigned to total without **OFFSEt**

For set points that have been assigned to total without **OFFSEt** during the **SEtUP** function, the preset # (1,2,3, or 4) will be illuminated. This indicates that the value for preset # (1, 2, 3, or 4) is being programmed.

Set the display for preset # (1,2,3, or 4)

The entire display will flash for three seconds.
Program preset values per **Five Basic Digit/Display Setting Instructions**, page 30.

then

final

Press **ENTER**, then press **ENTER** again when the **SEtPtS** (set points) function appears.

Preset values for set points assigned to total with OFFSEt

If a set point was assigned to total with **OFFSEt** during the **SEtUP** function, it means that this set point and the one before it function as a pair. That is, the first relay will always trip a specified number of counts before the second relay. This is called the preset offset value and it is programmed as the first preset in a pair of set points set up for **OFFSEt**. The second value in a pair of set points set up for **OFFSEt** represents the actual preset value.

Set the display for preset offset and preset values

The entire display will flash for three seconds.
Program presets per **Five Basic Digit/Display Setting Instructions**, page 30.

070.00

then

170.00

then





120.00

final

125.00

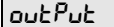
Isolated 4-20 mA Output Programming (outPut)

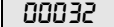
Programming the 4-20 mA transmitter output option for the meter does not require the use of a calibrator. The transmitter output can be calibrated so that a 4 mA output is produced for any rate measured by the meter. The 20 mA output may correspond to any rate that is at least 501 counts greater or smaller than the rate corresponding to 4 mA. (Ex. 4 mA = 0, 20 mA = 501) If the span between 4 and 20 mA is less than 501 counts, an **Error** message will appear and the previously programmed values will be retained in memory until a new set of values is accepted.

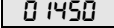
<p>Press ENTER, then press ENTER again when the Output menu appears</p>		
<p>Set the display for value at which 4 mA is produced</p> <p>The green LED labeled “4” will be on indicating the meter is ready to accept the value at which 4 mA is produced.</p> <p>The entire display will flash for three seconds. Program display value corresponding to 4 mA output per Five Basic Digit/Display Setting Instructions, page 30.</p>		 final 
<p>Set the display for value at which 20 mA is produced</p> <p>The green LED labeled “20” will now be on indicating the meter is ready to accept the value at which 20 mA is produced. Program this value in the same fashion as it was done above.</p>		 final 

4-20 mA Output Programming Confirmation

The values that have been programmed to produce the 4 and 20 mA outputs can be quickly checked to make sure they are the desired values. To do this, access the **outPut** routine by pressing **ENTER**, and then pressing **ENTER** again when **outPut** appears. Note display values when “4” and “20” LEDs are on and press **ENTER** before the display stops flashing.

Lockout and Display Selection Programming

Overview

The meter provides the user with the ability to restrict modification of programming values and to exclude menu titles from appearing during the menu scroll. Restricting modification of the programming values is accomplished by installing the lockout jumper (JP2). Excluding menu titles from the menu scroll is performed with the **dSPRAY** menu.

Lockout

The lockout jumper is used to restrict modification of calibration and programming values. It is labeled JP2, and it is located at the rear of the Main Board. When **ENTER** is pressed with the lockout jumper in place, **SCALE**, **CAL Ib**, **CutoFF**, **tBASE**, **tot CF**, and **dECEP** do not appear during the menu scroll, and thus cannot be modified.

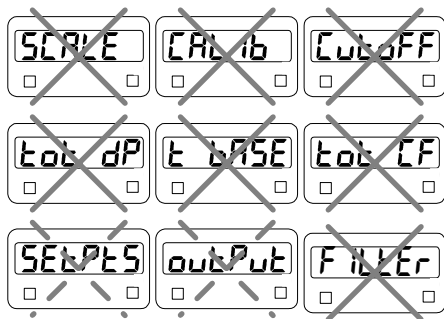

SEtPtS menu title always appears. Ability to change values may be restricted.

outPut menu title appears only if 4-20 mA output option is installed.

Figure 17. Functions Locked Out with Lockout Jumper

Notes:

1. The other function the lockout jumper performs is activating selections made through the **dSPRAY** menu. That is, selections made through the **dSPRAY** menu only become active when the lockout jumper is installed.
2. With the lockout jumper in place, the **SEtPtS** menu still appears. To program it so the set points, reset points or presets can only be viewed and not changed, it is necessary to set the **SEtPtS** menu in the **dSPRAY** menu to **n**. To be able to change these values, set **SEtPtS** menu in the **dSPRAY** menu to **4**.

Display Selection (*dSPY*)

The display (*dSPY*) menu is used to remove menu titles from appearing during the menu scroll. This feature is useful for eliminating unused menu titles from the menu scroll, making it impossible to perform certain functions, and making the display automatically toggle between rate and total.

For instance, the user may want to eliminate certain unused menu titles from the scroll that do not relate to a particular application such as those relating to flow totalization. The *dSPY* menu could be used to eliminate the *rSEt t* (reset total) and the *dSPY t* (display total) and thus streamline the menu.

A supervisor may want to make it impossible for an operator to perform certain functions, but still allow himself to do them without having to remember passwords or remove a hard-to-get-at jumper. For instance, a supervisor could program the meter with the batch presets he wants and disable the *SEtPtS* menu, thus making it impossible for a user to change the batch presets by using the *dSPY* menu. When the supervisor wants to change the batch presets, he can re-activate the *SEtPtS* menu and make his changes. Or a supervisor may want to make it impossible for an operator to reset the total via the front panel, but still allow himself to do it easily. This can be accomplished by removing the *rSEt t* (reset total) menu title from the menu scroll, thus making it impossible to reset the total via the front panel and then re-activating it when he wants to reset the total.

The user may want to make the display automatically toggle between rate and total. This can be accomplished by setting the *dSPY r* (display rate) and *dSPY t* (display total) menus to *n* (no), as described below.

With the lockout jumper in place, the menu titles *dSPY r*, *dSPY t*, *rSEt t*, *dSPY P*, *SEtPtS*, *dSPY*, and, *outPut* can still be accessed. The 4-20 mA output calibration points can be viewed, but cannot be modified.

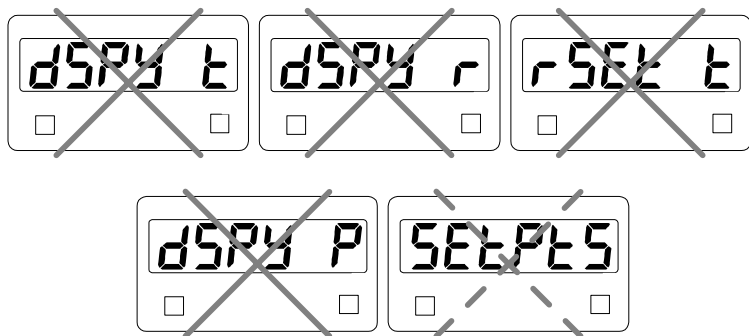







5SETP t5 menu title always appears.
Ability to change values may be restricted.

Figure 18. Menu Titles Excluded with *d5PLAY* Menu

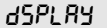
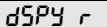
Notes:

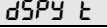
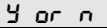
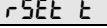
1. The user may program which of these routine titles are active during operation and which ones are not. See below for instructions.
2. Selections made through the display menu can be made with or without the lockout jumper installed, but only become active when the lockout jumper is installed.
3. With the lockout jumper in place, the *5SETP t5* menu still appears. To program it so the set points, reset points or presets can only be viewed and not changed, it is necessary to set the *5SETP t5* menu in the *d5PLAY* menu to *r*. To be able to change these values, set *5SETP t5* menu in the *d5PLAY* menu to *y*.

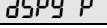
Include or Exclude Menu Titles from Menu Scroll

<p>Press ENTER, then press ENTER again when the dSPly (display) function appears. The meter will now scroll through the various menu titles that can be included or excluded. To program a menu title, press ENTER when it appears.</p>		
<p>Set menu scroll to include/exclude display rate dSPY r (display rate) will appear for 3 seconds. Press ENTER to set. Otherwise wait and meter moves on to next menu title.</p>		
<p>y or n (yes or no) will flash alternately. To include dSPY r in menu scroll, press ENTER when y is displayed. To exclude it, press ENTER when n is displayed.</p>		
<p>Set menu scroll to include/exclude display total dSPY t (display total) will appear for 3 seconds. Press ENTER to set. Otherwise wait and meter moves on to next menu title.</p>		
<p>y or n (yes or no) will flash alternately. To include dSPY r in menu scroll, press ENTER when y is displayed. To exclude it, press ENTER when n is displayed.</p>		
<p>Set menu scroll to include/exclude reset total rSEt t (reset total) will appear for 3 seconds. Press ENTER to set. Otherwise wait and meter moves on to next menu title.</p>		
<p>y or n (yes or no) will flash alternately. To include dSPY r in menu scroll, press ENTER when y is displayed. To exclude it, press ENTER when n is displayed.</p>		
<p>Set menu to include/exclude display peak dSPY P (display peak) will appear for 3 seconds. Press ENTER to set it. Otherwise wait and meter moves on to next menu title.</p>		
<p>y or n (yes or no) will flash alternately. To include dSPY r in menu scroll, press ENTER when y is displayed. To exclude it, press ENTER when n is displayed.</p>		

<p style="text-align: center;">Set menu scroll to include/exclude set points SEtPtS</p> <p>SEtPtS (set points) will appear for 3 seconds. Press ENTER to set. Otherwise wait and meter moves on to next menu title.</p>	<div style="border: 1px solid black; padding: 5px; display: inline-block;">SEtPtS</div>
<p>y or n (yes or no) will flash alternately. To include SEtPtS in menu scroll, press ENTER when y is displayed. To exclude it, press ENTER when n is displayed.</p>	<div style="border: 1px solid black; padding: 5px; display: inline-block;">y or n</div>

Notes:

1. Select **n** for both **dSPY r** and **dSPY t** to program the display to toggle between rate and total every 10 seconds.
2. Selecting **y** for **SEtPtS** will allow an operator to view and change set/reset points and presets even with the lockout jumper in place.
3. Selecting **n** for **SEtPtS** will still allow an operator to view set/reset points and presets, but will not allow making changes.
4. The total can be reset with an external push-button even if **rSEt t** is set to **n**.

Alternating Display

The display may be programmed to automatically toggle between rate and total every ten seconds. The alternating display is set up by selecting **n** (no) for both, **dSPY r** (display rate) and **dSPY t** (display total) on the **dSPLY** (display) menu.

Note: Selections made through the display menu can be made with or without the lockout jumper installed, but only become active when the lockout jumper is installed.

The Lockout jumper must be installed to see the alternating display or any other display selection made.

OPERATION

Overview

This instrument is a frequency/pulse input meter with flow rate, totalizer, and batch control capabilities housed in a 1/8 DIN high-impact plastic enclosure with a NEMA 4X front. It accepts pulse (± 125 mV to ± 12 V), square wave (0-5 V, 0-12 V, or 0-24 V), open collector (NPN or PNP), TTL, or switch contact closure signals; and displays these signals in engineering units on a 0.56" high 4½ digit LED display. The meter also provides one isolated 12 VDC or 24 VDC power supply to drive either the input or output loops. Options include up to 4 relays for alarms or batch controlling as well as an isolated 4-20 mA transmitter output.

The front panel of the meter consists of six 0.56" high seven-segment LEDs as well as nine programming/operational LEDs. The programming/operational LEDs provide the following indication:

LED	During Programming:	During Operation:
1	Alarm 1	Alarm 1
2	Alarm 2	Alarm 2
3	Alarm 3	Alarm 3
4	Alarm 4	Alarm 4
S	Set point Indicator	None
R	Reset point Indicator	None
4	4 mA Output Indicator	None
20	20 mA Output Indicator	None
R	Rate Indicator	Rate

The four alarm status LEDs indicate alarm condition only and do not represent relay status when set points are set up for non-latching relay mode. For instance, if alarm 1 is programmed for a high alarm at 500 with manual reset of the relays and the operator resets the relays when the display reads 650, the #1 LED will stay on until the display falls below 500.

Set points set up for latching relay mode will reflect the status of the LEDs, regardless of the status of the alarm condition. For instance, when a latching relay is acknowledged the corresponding status LED will extinguish.

Two Types of Display: Rate and Total

The meter has the capability to display both rate and total. The operator may toggle back and forth between flow rate and total automatically or manually. When the meter is displaying rate, an LED labeled **R** on the right side of the front panel, illuminates to indicate this. There is no loss of data while performing any of the programming or calibration operations; the meter continues working in the background even when values are being reprogrammed.

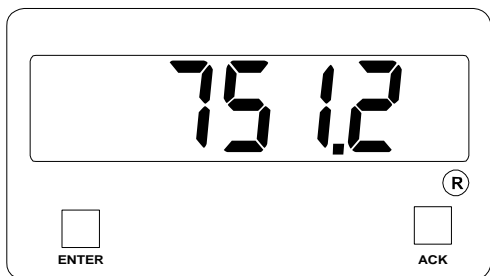

Figure 19. Meter Displaying Process/Rate

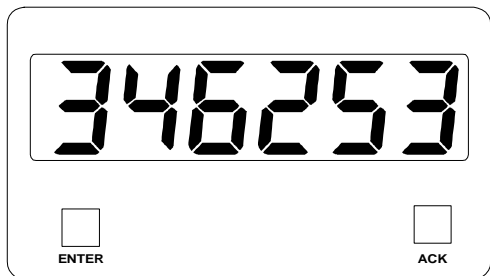

Figure 20. Meter Displaying Total

Basic Meter Operation

Overview

In its most basic form, the meter provides a digital display in engineering units of any frequency input signal. As a standard feature, the AC powered meters provide the power to drive either the input or the 4-20 mA output transmitter option.

ENTER and ACK Button Operation

In addition to programming the meter, the **ENTER** button is also used to operate the meter.

The **ACK** button is used to acknowledge the relays during operation and to quit main menu scroll during programming, diagnostic menu, and calibration.



The **ENTER** button performs the following operations with lockout jumper installed:

Function Displayed		Definition
<code>dSPY r</code>	Display Rate	Sets the rate as the default display
<code>dSPY t</code>	Display Total	Sets the total as the default display
<code>rSEt t</code>	Reset Total	Resets the totalizer to zero.
<code>dSPY P</code>	Display Peak	Displays the highest rate value captured
<code>rSEt P</code>	Reset Peak	Erases peak value from memory and captures a new reading
<code>dSPLY</code>	Display Selection	Activates or de-activates display functions
<code>d I99</code>	Diagnostic	Displays parameter settings one at a time for diagnostic purposes.

Display Peak & Reset Peak Operation (dSPY P & rSEt P)

The meter captures the highest rate reading and displays it through the **dSPY P** (display peak) function. The peak value may be reset using the **rSEt P** (reset peak) function.

Display Peak (Hold) Reading

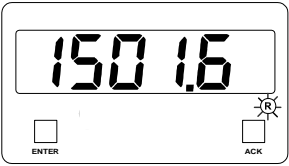
<p>Press ENTER, then press ENTER again when the dSPY P (display peak) menu-title appears.</p>		
<p>Meter displays peak reading The meter is now displaying the peak reading as indicated by the flashing green R LED on the right side.</p>		

Reset Peak Reading

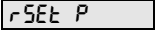
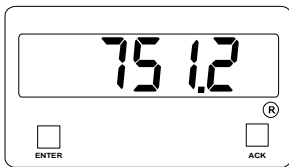
<p>Press ENTER, then press ENTER again when the rSEt P (reset peak) menu-title appears.</p>		
<p>Meter returns to displaying current value The meter is now displaying the current value. The flashing green R LED on the right side has stopped flashing.</p>		

Note:

While in the **dSPY P** (display peak) mode, the meter continues capturing new peaks; but it does not respond to signals below the last peak value captured; it remains “locked” on the peak display reading. For instance, if while the meter is displaying a peak of 100, the input increases to 150, the new peak of 150 will be displayed. If the input falls down to 125 before the peak display is reset, the meter will continue displaying 150 as the peak reading.



Rate Meter Operation

Overview

The meter can also be used to display flow rate and is available with a low-flow cutoff feature. Totalizer functions can be excluded from the menu scroll through the **dSPY r** function, if the user is not interested in total display.

Display Rate (**dSPY r**)

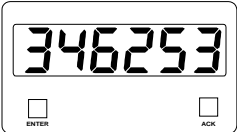
The user may toggle between a display of rate or total at any time. When displaying rate, the rate LED indicator will be illuminated. To change the display to rate:

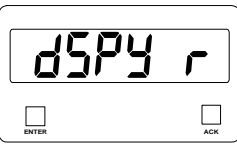
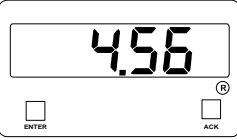
<p>To change the display from reading total to rate</p> <p>Press ENTER to begin scrolling through the functions.</p>	
<p>When dSPY r (display rate) appears, press ENTER.</p>	 
<p>The meter now displays rate and the green R LED on the right side is illuminated.</p>	

Low-Flow Cutoff (**LOWFF**)

The low-flow cutoff feature allows the meter to be programmed so that any input below the cutoff point is always displayed as zero on the rate display.

In multi-point calibration/scaling, the total is based on the rate display; so, inputs below the low-flow cutoff value will not affect the totalizer.

In K-factor scaling, the totalizer ignores the low-flow cutoff; the totalizer counts every incoming pulse regardless of the rate display.

Totalizer Operation

Overview



The total is displayed on a six-digit display that is capable of reading to 999,999. When the total exceeds 999,999, the display rolls over and begins counting from zero again without losing counts. The total can be reset at any time via the front panel, via an external switch closure, or when the meter reaches the highest preset value.

In multi-point calibration/scaling, the meter calculates the total based on rate display and field programmable total conversion factor to display total in engineering units. Time base must be selected according to time units in which rate is displayed.

In K-factor scaling, the meter calculates the total based on the input pulses, K-factor value, and total conversion factor.

Display Total (*dSPY t*)

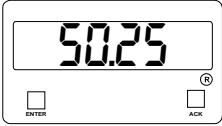
The user may toggle between a display of rate or total at any time. When displaying rate, the rate LED indicator will be illuminated.

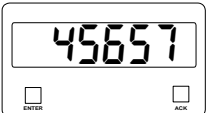
<p>To change the display from reading rate to total</p> <p>The meter is now displaying rate, as indicated by the green "R" LED illuminated on the right side of the display. Press ENTER to begin scrolling through the functions.</p>	
<p>When <i>dSPY t</i> (display total) appears, press ENTER.</p>	
<p>The meter now displays total.</p>	

Total Conversion Factor (*tot CF*) and Time Base (*t base*)

The total conversion factor is a number that is multiplied by the rate to compute the total. Time base is available in seconds, minutes, and hours.

Applications Using Conversion Factor and Time Base

The following tables illustrate the effect various total conversion factors and time bases have on the operation of the meter:

Application 1

Rate	Time Base	Total Conv. Factor	Total after one second	Total after one minute	Total after one hour	Total after one day
60 GPM	min	1 gal	1 gal	60 gal	360 gal	8640 gal

In the above application, a total conversion factor of 1 with a rate of 60 GPM results in a total of 60 gallons after 1 minute.

Application 2

Rate	Time Base	Total Conv. Factor	Total after one second	Total after one minute	Total after one hour	Total after one day
60 GPM	min	0.2	0.2 can	12 cans	720 cans	17280 cans

In the above application, 5-gallon paint cans are being filled and the user wants to keep track of the number of cans that have been filled, not the total gallons of paint that has been dispensed.

Totalizer Reset

The totalizer may be reset in any of three ways:

1. Via the front panel **ENTER** button
2. External contact closure
3. Automatically via highest preset value

Resetting Total Using the ENTER Button

<p>Press ENTER, then press ENTER again when the rSEt t (reset total) function appears. After ENTER is pressed, the total display resets to zero.</p>		<p>87652.0</p> <p>then</p> <p>rSEt t</p> <p>then</p> <p>0.0</p>
--	---	---

Note: It is possible to exclude the reset total function from the menu scroll. See Display Selection (dSPly), page 62 for details.

Resetting Total via External Contact Closure

The total may be reset at any time by closing a normally open push-button switch that is wired across terminals R and CM located on the Main Board connector. See Figure 11 on page 26 for details. Note that this switch is still functional even if reset total function has been removed from the menu scroll.

Resetting Total Automatically via User Selectable Preset

The meter can also be programmed so the total automatically resets when the total reaches a user selectable preset value.

Relays Operation

Overview

The relay capabilities of the meter expand its usefulness beyond simple indication to provide users with alarm and control functions. These capabilities include front panel alarm status LEDs as well as either 2 or 4 optional relays. There are four basic ways the relays can be used:

1. High or Low Alarms
2. Simple On/Off Control with 100% Adjustable Deadband
3. Automatic Batch Control
4. Manual Batch Control

Relays Auto Initialization

When power is applied to the meter, the front panel LEDs and alarm relays will reflect the state of the input to the meter. For instance, when meter is powered up, the following table indicates how the alarm LEDs and relays will react based on the various set and reset points:

Alarm #	HI or LO	Set point	Reset point	Power-up reading	Relay & LED
1	HI	1000	500	499	Off
2	LO	700	900	500	On
3	LO	250	400	500	Off
4	HI	450	200	500	On

Fail-Safe Operation

The following table indicates how the relays behave based on Jumper JP6 being installed or not installed:

Jumper JP6 on Display Board	Fail-safe	Relay coils energized in	Power failure
On	Enabled	Non-alarm state	Relays go to alarm state
Off	Disabled	Alarm state	Relays go to non-alarm state

Front Panel LEDs

The LEDs on the front panel provide status for the following:

LED	Status
1	Alarm 1
2	Alarm 2
3	Alarm 3
4	Alarm 4

LED	Status
S	Set point Indicator
R	Reset point Indicator
4	4 mA indicator
20	20 mA indicator
R	Rate indicator

The meter is supplied with four alarm points that include front panel LEDs to indicate alarm conditions. This standard feature is particularly useful for alarm applications that require visual-only indication. The front panel LEDs are controlled by the set and reset points programmed by the user. When the display passes a set point for a particular alarm, that alarm's LED will light up. When the meter passes back through that alarm's reset point the LED will go off. The front panel LEDs respond differently for latching and non-latching relays.

For non-latching relays, the LED is always off during normal condition and always on during alarm condition, regardless of the state of the relay.

For latching relays, the alarm LEDs reflect the status of the relays, regardless of the alarm condition. The following tables illustrate how the alarm LEDs function in relation to the relays and the acknowledge button:

Latching and Non-Latching Relay Operation

Rate relays can be set up for latching or non-latching operation.

Relay key legend for following tables

Key	Relay condition
On	Tripped
Off	Reset
Ack	Acknowledged

The On and Off keys do not refer to the status of the relay's coil, which depends on the fail-safe mode selected.

Non-Latching Relay**Automatic reset only JP3(1-4 off)**

Condition	LED	Relay
Normal	Off	Off
Alarm	On	On
Ack (No effect)	On	On
Normal	Off	Off

In this application, the meter is set up for automatic reset and non-latching relay. Acknowledging the alarm while it is still present has no effect on either the LED or the relay. When the alarm finally goes away, the relay automatically resets and the LED also goes off.

Non-Latching Relay**Automatic + manual reset at any time JP3(1-4 on)**

Condition	LED	Relay
Normal	Off	Off
Alarm	On	On
Normal	Off	Off

In this application, the meter is set up for automatic and manual reset at any time and non-latching relay. The LED and the relay automatically reset when the meter returned to the normal condition.

Automatic + manual reset at any time JP3(1-4 on)

Condition	LED	Relay
Normal	Off	Off
Alarm	On	On
Ack	On	Off
Normal	Off	Off

In this application, the meter is also set up for automatic and manual reset at any time. But this time, an operator acknowledges the alarm manually while it still exists. This causes the relay to reset, but the LED stays on until the meter returns to the normal condition. Remember, for non-latching relays, the LED is always off during normal condition and always on during alarm condition, regardless of the state of the relay.

Latching Relay**Manual reset only after signal passes reset point JP3(1-4 off)**

Condition	LED	Relay
Normal	Off	Off
Alarm	On	On
Ack (No effect)	On	On
Normal	On	On
Ack	Off	Off

In this application, the meter is set up for manual reset only after the signal passes the reset point of the latching relay. Acknowledging the alarm while it is still present has no effect on either the LED or the relay. When the alarm is acknowledged after it returns to the normal state, the LED and the relay go off. Notice that the LED remained on, even after the meter returned to the normal condition. This is because, for latching relays, the alarm LEDs reflect the status of the relays, regardless of the alarm condition.

Manual reset only after signal passes reset point JP3(1-4 off)

Condition	LED	Relay
Normal	Off	Off
Alarm	On	On
Normal	On	On
Ack	Off	Off

In this application, the meter is set up for manual reset only after the signal passes the reset point of the latching relay. When the alarm is acknowledged after it returns to the normal state, the LED and the relay go off.

Manual reset any time JP3(1-4 on)

Condition	LED	Relay
Normal	Off	Off
Alarm	On	On
Ack	Off	Off

In this application, the meter is set up for Manual reset at any time. Acknowledging the alarm even if the alarm condition is still present resets the relay and turns off the LED.

Acknowledging Relays

There are two ways to acknowledge relays programmed for manual reset: via the front panel ACK button and remotely via a switch wired across AK and CM terminals on the Main Board. When the ACK button or a switch wired across the AK and CM terminals is closed, all relays programmed for manual reset will reset.

The total display is not affected by this action and therefore pressing the ACK button or closing the acknowledge switch will not reset the total.

Delay on Release (dELAY)

The meter can be programmed so that when the highest preset value is reached the total automatically resets to zero (Automatic Batch Control). A delay on release can be programmed to reset the total relays after the delay has elapsed. The delay can be programmed between 1 and 999 seconds.

Example: Under the **SEtUP** menu, relay 1 and 2 are assigned to total, **OFFSEt** is not selected, internal total reset (**I**) is selected and a **dELAY** of 60 second is programmed. Under **SEtPTS** menu, the preset values are programmed as follows:

SEt 1 (preset 1): 1000

SEt 2 (preset 2): 2000

When the total reaches 1000, relay 1 transfers. The total keeps increasing until it reaches 2000; at that moment, relay 2 transfers, the total resets to zero automatically, delay on released starts. Then 60 seconds later relays 1 and 2 reset automatically and are ready to start a new batch.

Priority Batch Programming or Quick Presets

For some batch control applications it may be necessary to change the presets frequently. The meter has a Quick Preset change feature that allows all presets to be changed without entering the programming routine.

To change presets without entering the programming routine press and hold the **ENTER** button for more than 3 seconds. The meter will go immediately to the first preset; the user can now program all presets. After the last preset has been programmed the meter returns to reading the rate or total.

It is recommended to disable the process while changing presets.

See application note AN-0001 at predig.com for more details.

Switching Inductive Loads

The meter has the ability to suppress electrical noise generated by switching inductive loads. However installing resistor-capacitor (RC) networks improves performance and prolongs the life of the meter's relay contacts. This suppression can be obtained with RC networks assembled by the user or purchased as complete assemblies. Refer to the following circuits for RC network assembly and installation:

Switching AC and DC Loads

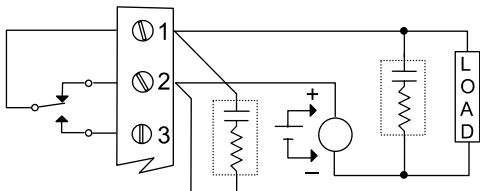

Figure 21. AC and DC Loads Protection

Choose R and C as follows

R: 0.5 to 1 Ω for each volt across the contacts

C: 0.5 to 1 μF for each amp through closed contacts

Notes:

1. Use capacitors rated for 240 VAC.
2. RC networks may affect load release time of solenoid loads, check to confirm proper operation.
3. Install the RC network at the meter's relay screw terminals. An RC network may also be installed across the load. Experiment for best results.

Switching Low Voltage DC Loads

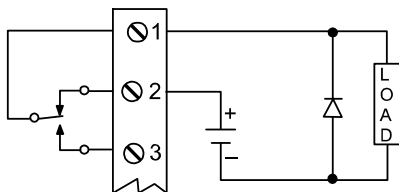

Use a diode with a reverse breakdown voltage two to three times the circuit voltage and forward current at least as large as the load current.

Figure 22. Low Voltage DC Loads Protection

RC Networks Available from Precision Digital

RC networks are available from Precision Digital and should be applied to each relay contact switching an inductive load. Part number PDX6901.

Lockout and Display Selection Operation

Overview

The meter provides the user with the ability to restrict modification of programming values and to exclude menu titles from appearing during the menu scroll. Restricting modification of the programming values is accomplished by installing the lockout jumper JP2. Excluding menu titles from the menu scroll is performed with the display menu.

Low Voltage Detector

The meter has a circuit, which monitors the line voltage. To protect against data loss the meter will shut down, after saving the total, when the voltage falls below specifications.

At power up the display normally flashes a test display of **188888** for a few seconds. If the line voltage is below specifications the meter will flash **18888L** until the problem is corrected.

Diagnostic (d 189) Feature

Overview

The diagnostic menu in the meter provides an easy way to view and write down the parameter settings. The information gathered through the diagnostic menu will be helpful to determine if a wrong setting is causing the operation of the meter to be undesirable.

Operation

When the diagnostic menu is entered, the function and programmed parameters setting will be displayed one at a time. Press **ENTER** to step through the functions and settings. If **ENTER** is not pressed within 10 seconds, the display will move to the next function or setting. To exit the diagnostic menu press the **ACK** button at any time.

Reset Meter to Factory Defaults

1. Remove the snap-off front cover, see page 81.
2. Using a pair of needle-nose pliers, short out the solder pads located on the top and bottom of the Main Board, to the right of the **ACK** button below JP6 (see Figure 2 on page 20), until the display shows "rE5Et".
3. Press the **ENTER** button. The meter starts scrolling the menus.
4. Press the **ACK** button, at any time, to exit the menu scroll.

OPTIONS CARD REMOVAL & INSTALLATION

Meter options are installed at the factory. It is **NOT** necessary to remove the circuit boards from the case to disable the relays' fail-safe operation. The fail-safe jumper is located on the Display Board, see Figure 2 on page 20. Refer to the following instructions and illustrations to remove the snap-off cover and the circuit boards from the case.



Disconnect power prior to performing the following operations.

To remove the front cover from the case:

The meter's snap-off cover is held in place by 6 latches that snap into notches on the snap-off cover. To remove the snap-off cover from the meter, grasp it firmly on its top and bottom edges and pull it forward. The latch plate remains around the meter's case.

To remove the circuit boards from the case:

1. Unscrew the retaining screws holding the circuit boards to the case.
2. Remove the screw terminal connectors at the rear of the meter.
3. Push the boards through the case by applying pressure to the circuit boards at the rear of the meter. Apply pressure evenly to both boards.
4. Do not apply pressure to the vertical Display Board.

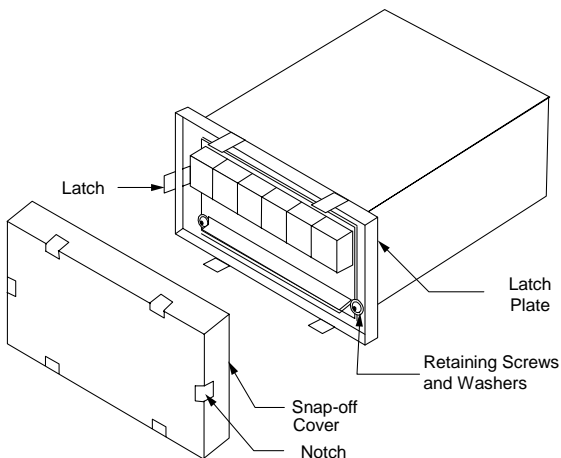

Figure 23. Front Cover Removal

5. Jumper J2 on Options Board must NOT be installed on meters that have the fail-safe jumper JP6 on the Display Board.
6. To avoid electric shock, re-install the circuit boards in the case prior to applying power.

All programming and calibrating can be performed with the circuit boards installed in the case.

To re-install the meter in its case:

1. Fold the Options Board over the Main Board, grasp both boards so the Main Board is on the bottom and the two Boards are separated by about an inch.
2. Insert the two boards together into the case. Be sure both the top and bottom boards engage the rails, which hold them in place.
3. Do not press on the Display Board when seating the assembly in the case.
4. Install washers and retaining screws in 4 corners of meter and install front cover.

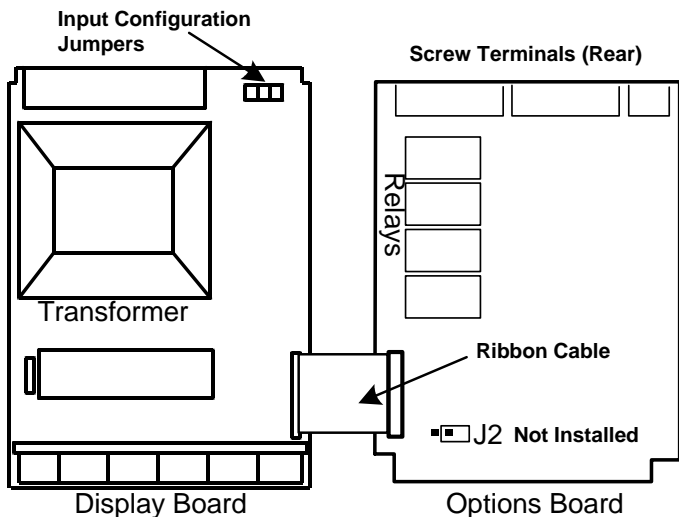

Figure 24. Options Card Installation

PROGRAMMED PARAMETER SETTINGS

The following table shows the factory setting for most of the programmable parameters on the meter. Next to the factory setting, record the new setting for the particular application.

Model: _____ S/N: _____ Date: _____

Parameter	Display	Factory Setting	User Setting
Input range		0-30,000 Hz	
Type of signal		0-12V square wave pulse	
Calibration mode	Factor	1.000	
Filter	HI SPD	High speed filter	
Total dec. point		999999	
Rate decimal point		29999	
Cutoff value	CUTOFF	- 19999	
Time base	SEC	Second	
Low gate	L0	10	
High gate	H1	30	
Total conv. factor	tot CF	1000	
Set point setup	SET 1	tot RL	
	SET 2	tot RL	
	SET 3	rRE	
Latching relay	LATCH	Non-latching	

Parameter	Display	Factory Setting	User Setting
	SEt 4	rRE	
Latching relay	LRECH	Non-latching	
Total reset mode	ERSE	External total reset	
Set point	SEt 1	1000	
	SEt 2	4000	
	SEt 3	7000	
	(Reset 3)	6000	
	SEt 4	9000	
	(Reset 4)	8000	
4-20 mA out	(4 mA)	00000	
	(20 mA)	10000	
Display selection	dSPY r	YES	
	dSPY t	YES	
	rSEt t	YES	
	dSPY P	YES	
	SEtPt5	no	

User Set point Setup and Programming Table

Parameter	Display	User Setting
Set point 1	SEt 1	
	LALCH	
Set point 2	SEt 2	
	LALCH	
	OFFSEt	
Set point 3	SEt 3	
	LALCH	
	OFFSEt	
Set point 4	SEt 4	
	LALCH	
	OFFSEt	
Total reset mode	I or E	
Delay on release	dELAY	
Set point 1	SEt 1	
Reset point 1	(Reset 1)	
Set point 2	SEt 2	
Reset point 2	(Reset 2)	
Set point 3	SEt 3	
Reset point 3	(Reset 3)	
Set point 4	SEt 4	
Reset point 4	(Reset 4)	

MOUNTING DIMENSIONS

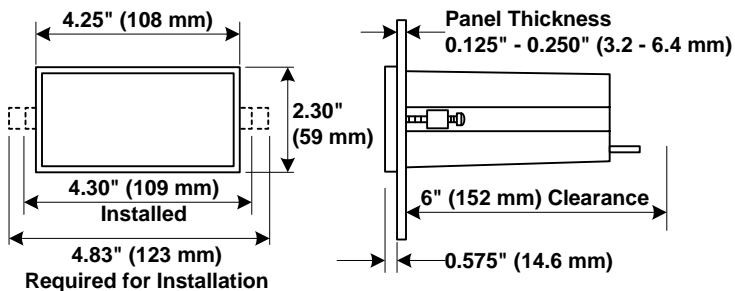
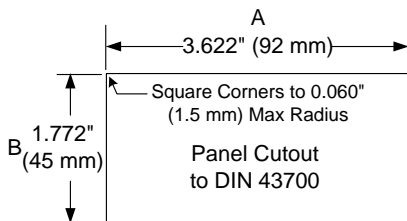

Figure 25. Mounting Dimensions



Tolerances:

- A: +0.032 (+0.8 mm)
-0.000 (-0.0 mm)
- B: +0.024 (+0.6 mm)
-0.000 (-0.0 mm)

Figure 26. Panel Cutout Dimensions

Notes:

1. Panel cutout required: 1.772" x 3.622" (45 mm x 92 mm) 1/8 DIN
2. Panel thickness: 0.125" - 0.250" (3.2 mm - 6.4 mm)
3. Clearance: Allow 6" (152 mm) behind the panel

OTHER PRECISION DIGITAL PRODUCTS

Model	Description
PD118	MINIMUX [®] 8 Point Scanner
PD141AFO	VIGILANTE [®] four Point Annunciator with First-Out
PD202-253	Digital Pressure Gauges
PD602	Dart Low-Cost 1/8 DIN Process Meter
PD644	Javelin D High-Voltage DC Panel Meter
PD650	2.3" LED NEMA 4X Large Display Process Meter
PD655	1.0" LED NEMA 4X Large Display Process Meter
PD656	0.8" LED Exp-Proof Large Display Process Meter
PD660	Low-Cost NEMA 4X Loop Powered Meter
PD661	Low-Cost Exp-Proof Loop Powered Meter (FM & CSA)
PD673	4½ Digit Loop Powered 1/8 DIN Meter
PD675	4½ Digit Loop Powered NEMA 4X Meter (FM & CSA)
PD677	4½ Digit Loop Powered Exp-Proof Meter
PD685	3½ Digit Loop Powered NEMA 4X Meter (General Purpose)
PD686	3½ Digit Loop Powered NEMA 4X Meter (FM & CSA)
PD687	3½ Digit Loop Powered Exp-Proof Meter (FM & CSA)
PD690	1/8 DIN Analog Input Process Meter (UL Listed)
PD691	1/8 DIN Strain Gauge & mV Input Meter (UL Listed)
PD692	1/8 DIN Analog Input Flow Rate/Totalizer (UL Listed)
PD696	1/8 DIN Loop Powered Flow Rate/Totalizer
PD697	NEMA 4X Loop Powered Flow Rate/Totalizer
PD698	Exp-Proof Loop Powered Flow Rate/Totalizer (FM & CSA)
PD740	Javelin T TC & RTD Temperature Meter (Low-Cost)
PD750	TC & RTD Temperature Meter (UL Listed)
PD751-752	10 Ω Cu & 120 Ω Ni RTD Temperature Meters (UL Listed)
PD755	1.0" LED NEMA 4X Large Display Temperature Meter
PD756	0.8" LED Exp-Proof Large Display Temperature Meter
PD757	2.3" LED NEMA 4X Large Display Temperature Meter
PD765	Trident Process & Temperature Meter (UL Listed)
PD865	Snooper Modbus Serial Input Meter
PD940-981	ConsoliDator [®] Multi-Channel Controllers

How to Contact Precision Digital

- For Technical Support please
call: (800) 610-5239 or (508) 655-7300
fax: (508) 655-8990
e-mail: support@predig.com
- For Sales Support or to place an order please
call: (800) 343-1001 or (508) 655-7300
fax: (508) 655-8990
e-mail: sales@predig.com
- For Extended Warranty, Setup & Calibration Services please visit
www.predig.com
- For an online version of this instruction manual please visit
www.predig.com



www.predig.com