



**$\frac{1}{16}$ -DIN  
PROFILER/CONTROLLER**

**Product Manual**

**59129-2**

# HOW TO USE THIS MANUAL

This manual comprises two volumes:

## VOLUME I OPERATING INSTRUCTIONS

<b>SECTION 1</b>	Monitoring the process and adjusting the setpoint Starting/holding/releasing/aborting a program Monitoring a running/held program Manual Control
<b>SECTION 2</b>	Creating/editing a program Using Guaranteed Soak Band Segment Event Status
<b>SECTION 3</b>	Setting up the controller parameters
<b>SECTION 4</b>	Setting up and using the communications link between the Profiler/Controller and your computer

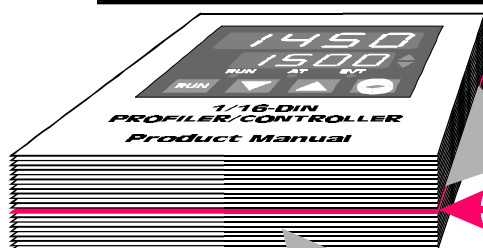

*To find a specific topic, refer to the index at the rear of this manual*

## VOLUME II INSTALLATION & CONFIGURATION INSTRUCTIONS

<b>SECTION 1</b>	Panel-mounting and wiring-up the Profiler/Controller
<b>SECTION 2</b>	Selecting the required input/output type(s)
<b>SECTION 3</b>	Matching software to hardware fitted Selecting input range, control action, alarm type(s) and Program Mode
<b>APPENDIX A</b>	Product specification
<b>APPENDIX B</b>	Summary of front panel displays



*The functions described in Volume II must be performed only by personnel who are trained, equipped and authorised to do so.*

# **$\frac{1}{16}$ -DIN PROFILER/CONTROLLER**

## **PRODUCT MANUAL**

### **VOLUME I OPERATING INSTRUCTIONS**



In normal operation, the operator must not remove the Profiler/Controller from its housing or have unrestricted access to the rear terminals, as this would provide potential contact with hazardous live parts.



Installation and configuration must be undertaken only by technically-competent servicing personnel. This is covered in Volume II of this manual.

## **CONTENTS**

<b>1</b>	<b>BASE MODE</b>	<b>1-1</b>
1.1	DISPLAY SEQUENCE - NO PROGRAM RUNNING	1-1
1.2	STARTING A PROGRAM	1-2
1.3	PUTTING A PROGRAM IN HOLD	1-2
1.4	RELEASING A PROGRAM FROM HOLD	1-2
1.5	ABORTING A PROGRAM	1-2
1.6	DISPLAY SEQUENCE - PROGRAM RUNNING	1-3
1.7	RaPID CONTROL FEATURE	1-4
1.8	PRE-TUNE FEATURE	1-4
1.9	ENGAGING BOTH PRE-TUNE AND RaPID FEATURES	1-5
1.10	INDICATION OF PRE-TUNE AND RaPID STATUS	1-5
1.11	VIEWING THE HARDWARE DEFINITION CODE	1-6
1.12	MANUAL CONTROL	1-7

<b>2</b>	<b>PROGRAM DEFINITION MODE - CREATING/EDITING A PROGRAM</b>	<b>2-1</b>
2.1	ENTRY	2-1
2.2	CREATING A PROGRAM	2-2
2.3	DEFAULT VALUES AND ADJUSTMENT RANGES	2-9
2.4	EXIT FROM PROGRAM DEFINE MODE	2-9
<b>3</b>	<b>CONTROLLER SET-UP MODE</b>	<b>3-1</b>
3.1	PARAMETER DETAILS	3-3
3.2	EXIT FROM CONTROLLER SET-UP MODE	3-9
<b>4</b>	<b>MODBUS COMMUNICATIONS</b>	<b>4-1</b>
4.1	INTRODUCTION	4-1
4.2	MODBUS FUNCTIONS SUPPORTED	4-1
4.3	MESSAGE FORMATS	4-1
4.4	PARAMETER NUMBERS	4-7
4.5	PROFILER STATUS BYTE	4-11
4.6	PROFILER COMMANDS	4-11

# 1 BASE MODE

## 1.1 DISPLAY SEQUENCE - NO PROGRAM RUNNING

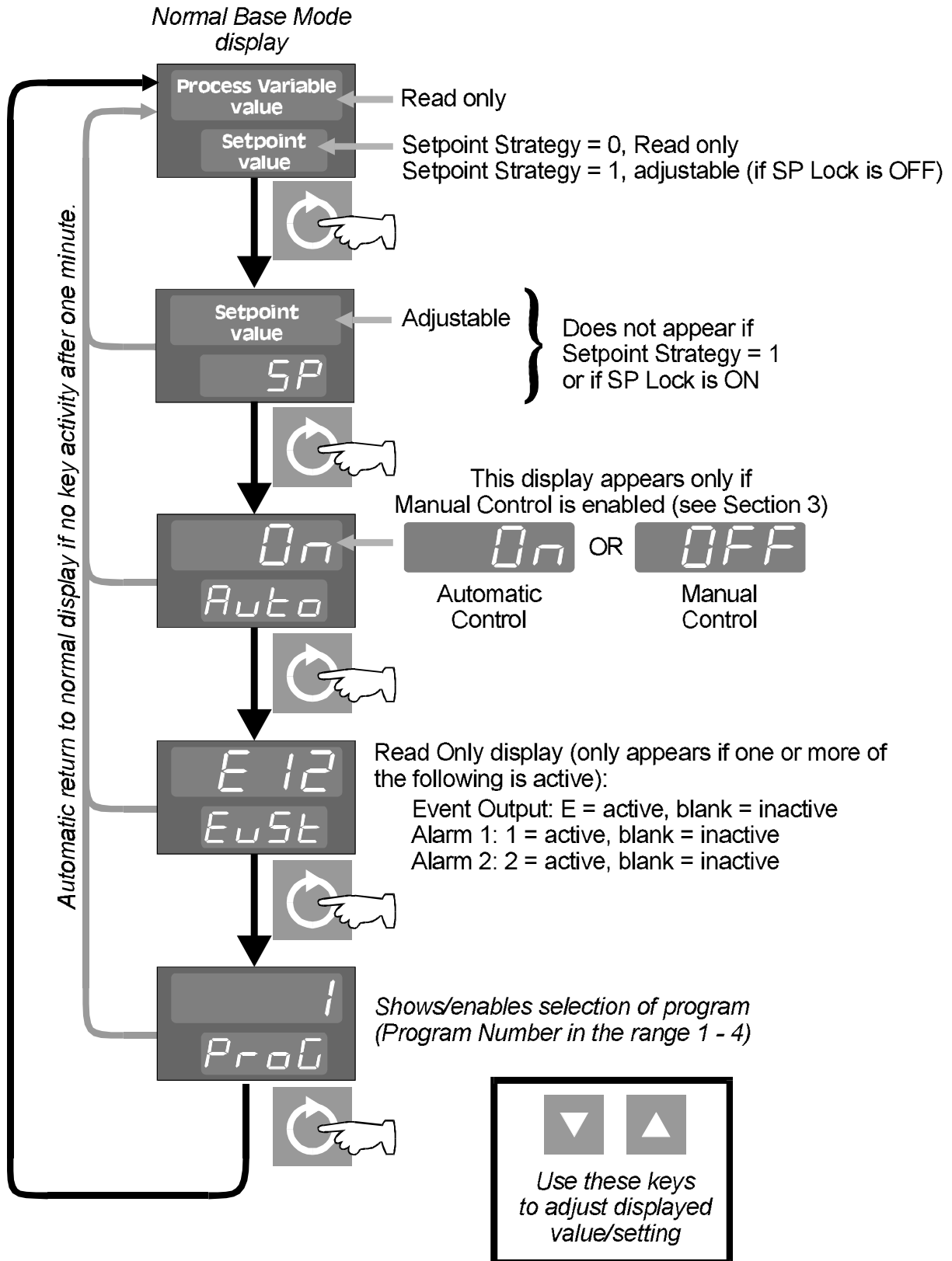

## 1.2 STARTING A PROGRAM

To start a program running:

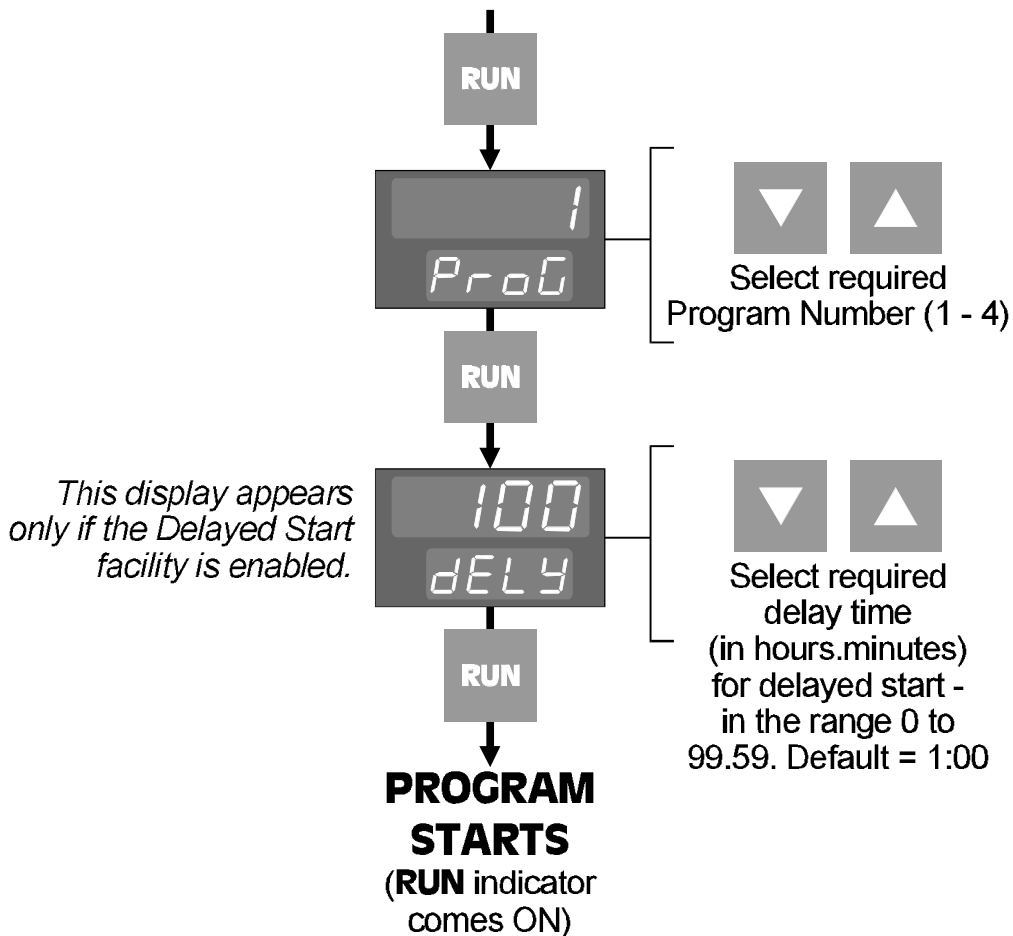

## 1.3 PUTTING A PROGRAM IN HOLD

A program can be put in Hold (i.e. frozen) at any time whilst it is running. The program setpoint will stay at its value at the instant the program entered Hold until the program is released (see Subsection 1.4) or aborted (see Subsection 1.5). To put a program in hold, momentarily press the **RUN** key. The **RUN** indicator will flash whilst the program is in hold.

## 1.4 RELEASING A PROGRAM FROM HOLD

To release a program currently in Hold, momentarily press the **RUN** key. The **RUN** indicator will then go ON continuously.

## 1.5 ABORTING A PROGRAM

To abort the current-running (or held) program, hold down the **RUN** key for 5 seconds. The program will be aborted, the **RUN** indicator will go OFF and the normal Controller functions will be resumed.

NOTE: When a program is aborted, the instrument returns to the Controller Setpoint value. If a program is successfully completed, the Controller Setpoint is automatically set to the final setpoint value of the program. If it is desired to restore the initial Controller Setpoint value after the program is completed, this value should be used as the program Final Setpoint value.

### 1.6 DISPLAY SEQUENCE - PROGRAM RUNNING

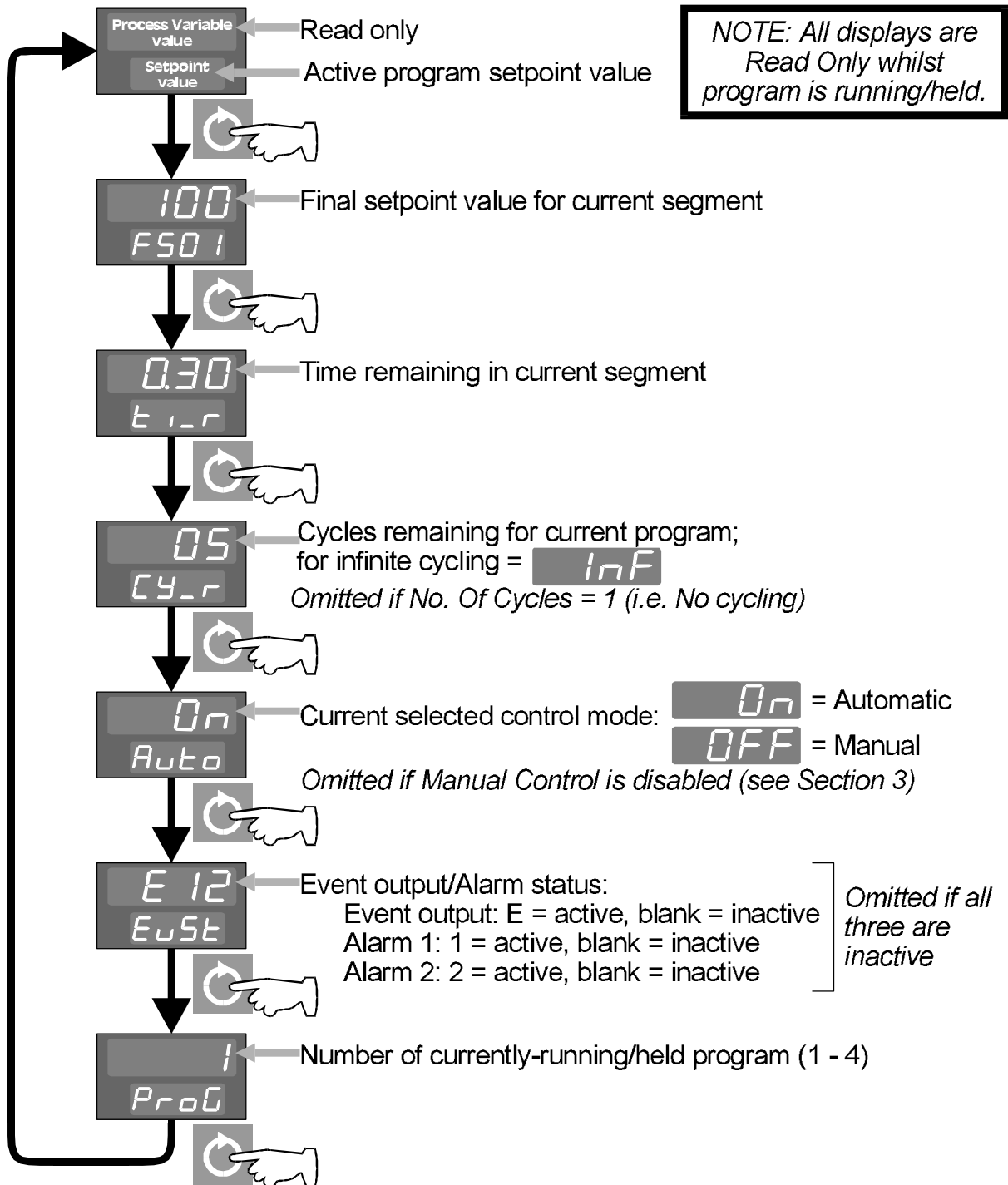

## 1.7 RaPID CONTROL FEATURE

The RaPID control feature may be used when extra fast responses and minimum overshoot are required. The RaPID feature works best when PID terms are well-tuned; therefore, it is recommended that the Pre-Tune feature (see Subsection 1.8) is run before the RaPID feature is engaged.

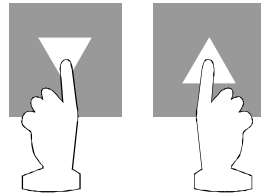

Press simultaneously twice  
in quick succession

To dis-engage RaPID control, use the same key actions. *NOTE: The RaPID feature cannot be engaged if Proportional Band 1 or Proportional Band 2 is set to 0.*

## 1.8 PRE-TUNE FEATURE

This facility may be used to provide initial tuning of the Controller's PID parameters. Pre-Tune may be engaged (and subsequently dis-engaged) as follows:

### To engage:

- 1 With Controller showing a normal Operator Mode display:

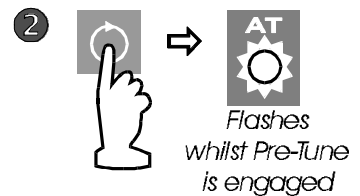
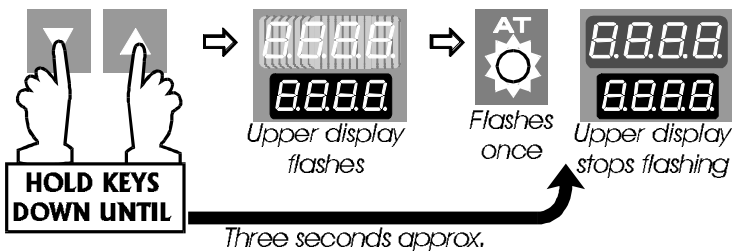

### To dis-engage:

- 1 With Controller showing a normal Operator Mode display:

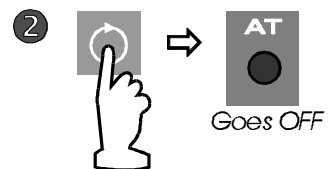
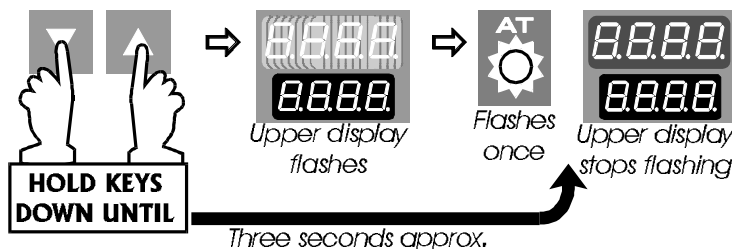

**NOTE:** The Pre-Tune facility will not engage if (a) a program is currently running, (b) the process variable is within 5% of input span of the setpoint, or (c) an erroneous key sequence is used. Pre-Tune is a single-shot process which automatically dis-engages itself when completed.



### 1.9 ENGAGING BOTH PRE-TUNE AND RaPID FEATURES

The Pre-Tune and RaPID features can be engaged in one key action sequence:

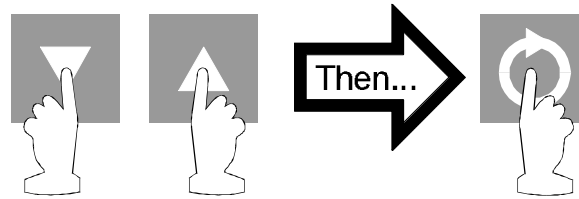

Press simultaneously twice in quick succession

Pre-Tune will operate first. When it is completed it will dis-engage itself and the RaPID feature will then operate automatically.

### 1.10 INDICATION OF PRE-TUNE AND RaPID STATUS

The responses to the RaPID feature being engaged are:

Pre-Tune Status when RaPID engaged	Response	Indication
Not operational.	RaPID activated.	<b>AT</b> indicator goes ON.
Operational.	Pre-Tune completes routine, then RaPID activated.	<b>AT</b> indicator flashes at double rate then comes ON.

The responses to the RaPID feature being dis-engaged are:

Pre-Tune Status when RaPID dis-engaged	Response	Indication
Not operational.	RaPID de-activated.	<b>AT</b> indicator goes OFF.
Operational.	Pre-Tune completes routine, then RaPID de-activated - return to normal control.	<b>AT</b> indicator flashes at double rate then goes OFF.

The responses to Pre-Tune being engaged are:

RaPID status when Pre-Tune engaged	Response	Indication
Not operational.	Pre-Tune activated and routine completed	<b>AT</b> indicator flashes at normal rate the goes OFF.
Operational.	RaPID interrupted, Pre-Tune activated. Pre-Tune completes routine, then RaPID control resumed.	<b>AT</b> indicator flashes at double rate then goes ON.

The responses to Pre-Tune being dis-engaged (manually or automatically) are:

RaPID Status when Pre-Tune dis-engaged	Response	Indication
Not operational.	Pre-Tune dis-engaged, normal control resumed.	<b>AT</b> indicator goes OFF.
Operational.	Pre-Tune dis-engaged, RaPID control resumed.	<b>AT</b> indicator goes ON.

### 1.11 VIEWING THE HARDWARE DEFINITION CODE

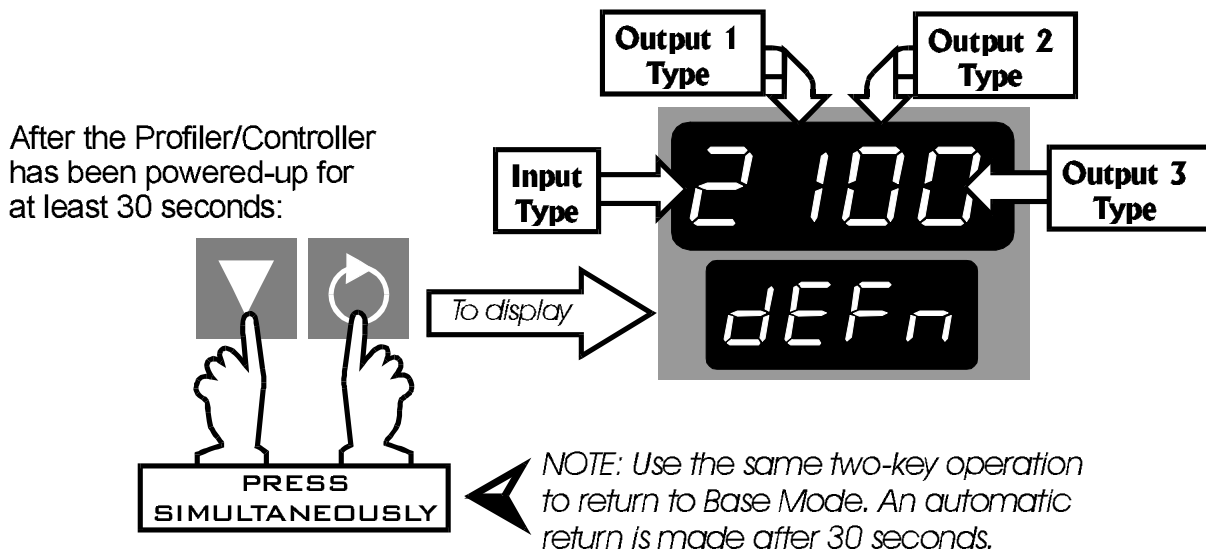

**NOTE:** An automatic return is made to the normal Base Mode display after 30 seconds.



The Hardware Definition Code has the following significance:



Value	0	1	2	3	4	5	7	8
Input		RTD/ Linear DC mV	Thermo- couple	Linear DC mA	Linear DC V			
Output 1		Relay	SSR Drive	DC 0 - 10V	DC 0 - 20mA	DC 0 - 5V	DC 4 - 20mA	Solid State
Output 2/3	Not fitted	Relay	SSR Drive	DC 0 - 10V	DC 0 - 20mA	DC 0 - 5V	DC 4 - 20mA	Solid State*



\* Output 2 only

## 1.12 MANUAL CONTROL

In Base Mode, with no program running or held, Manual Control may be selected as follows:



1 Press  till front panel shows 

2 Press  or  to change display to 



3 Press  till front panel shows 

The lower display shows the output power in the form Pxxx (xxx is in the range 000% to 100% of maximum output power). This may be adjusted using the Up and Down keys.

To return to automatic control:

1 Press  till front panel shows 

2 Press  or  to change display to 

3 Press  till front panel shows 

# 2 PROGRAM DEFINITION MODE - CREATING/EDITING A PROGRAM

## 2.1 ENTRY

To enter Program Definition Mode:

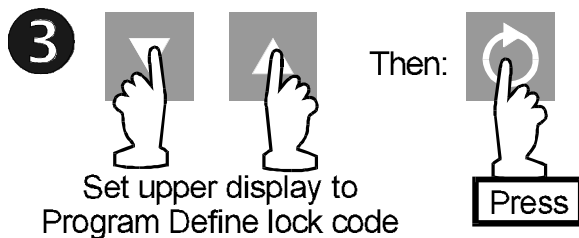
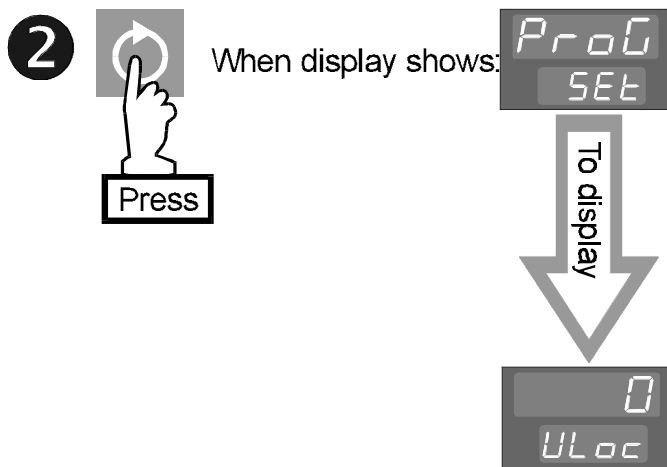
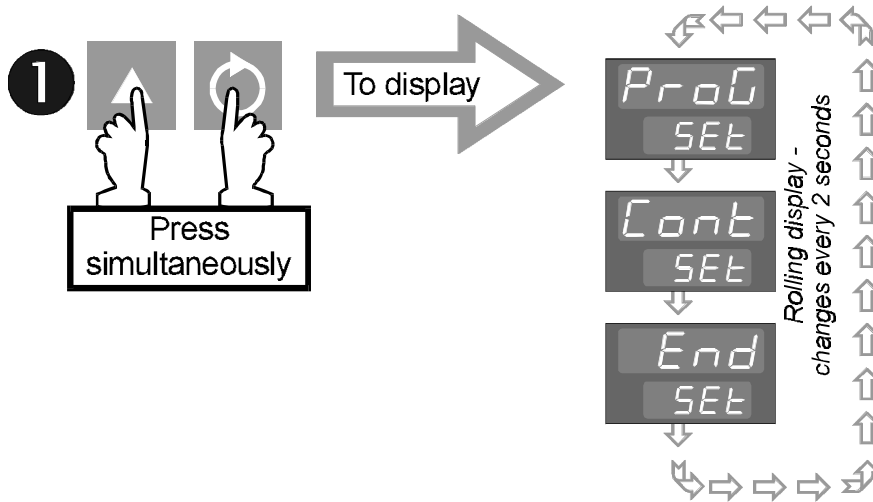

NOTE: If the Program Define Mode lock code has been set to 0, pressing the Scroll key in Step 2 will give direct access to Program Define Mode; no entry of lock code is required.

Upon entry into Program Define Mode, the first Segment Definition parameter for Segment 1 of Program 1 will be displayed.

## 2.2 CREATING A PROGRAM

A program is created in two steps:

1. Define the segments of your program; the parameters used depend on what Program Mode has been configured - Rate Mode (see Subsection 2.2.2) or Time Mode (see Subsection 2.2.3). The segment definitions determine whether the selected segment is a Ramp Segment, a Dwell (soak) Segment or an End Segment.
2. Set the required Program Options (see Subsection 2.2.4). These determine:
  - (i) The number of cycles performed by the program,
  - (ii) The timebase to be used (hours/minutes or minutes/seconds)
  - (iii) The width of the Guaranteed Soak Band (if enabled),
  - (iv) The state of the event indicator for each segment in the program,
  - (v) The lock code to be used for subsequent entries into Program Define Mode.

### 2.2.1 Basic Guidelines

1. The Profiler/Controller may contain up to four programs.
2. Each program may comprise up to 16 segments.
3. Each segment may be:
  - (a) a Ramp Segment (setpoint changing at a defined rate or between the initial value and a pre-determined final value over a defined time),
  - (b) a Dwell Segment (setpoint constant for a defined time,) or
  - (c) an End Segment (marking the end of the program).
4. A program may contain only one End Segment (the last segment in the program).
5. If the program comprises 16 segments, Segment 16 is automatically an End Segment.

### 2.2.2 Defining Segments - Rate Mode

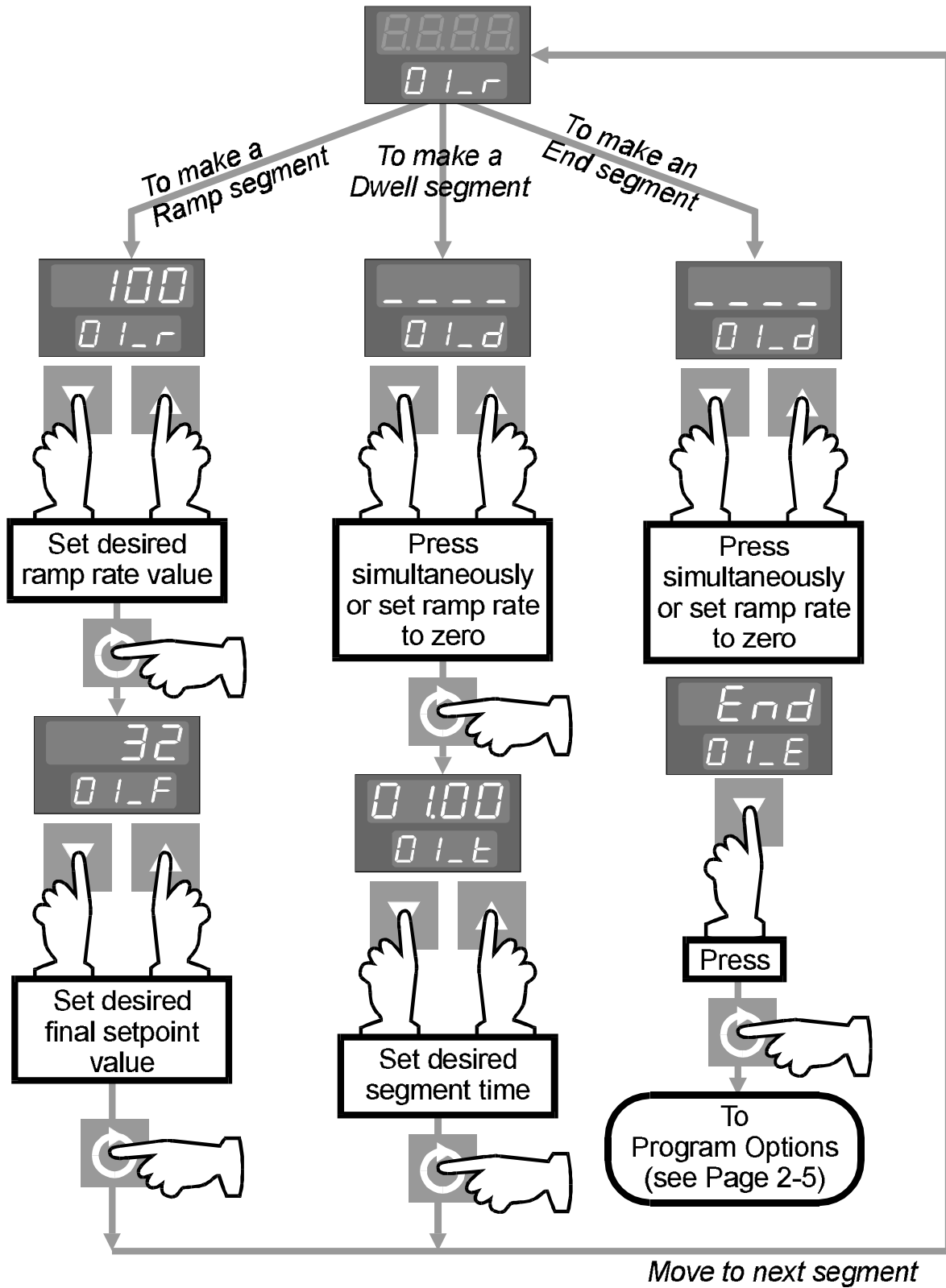

NOTE: Ramp rate is in units/hour if **BASE = hour**  
 Ramp rate is in units/minute if **BASE = min** } See Subsection 2.2.4

### 2.2.3 Defining Segments - Time Mode

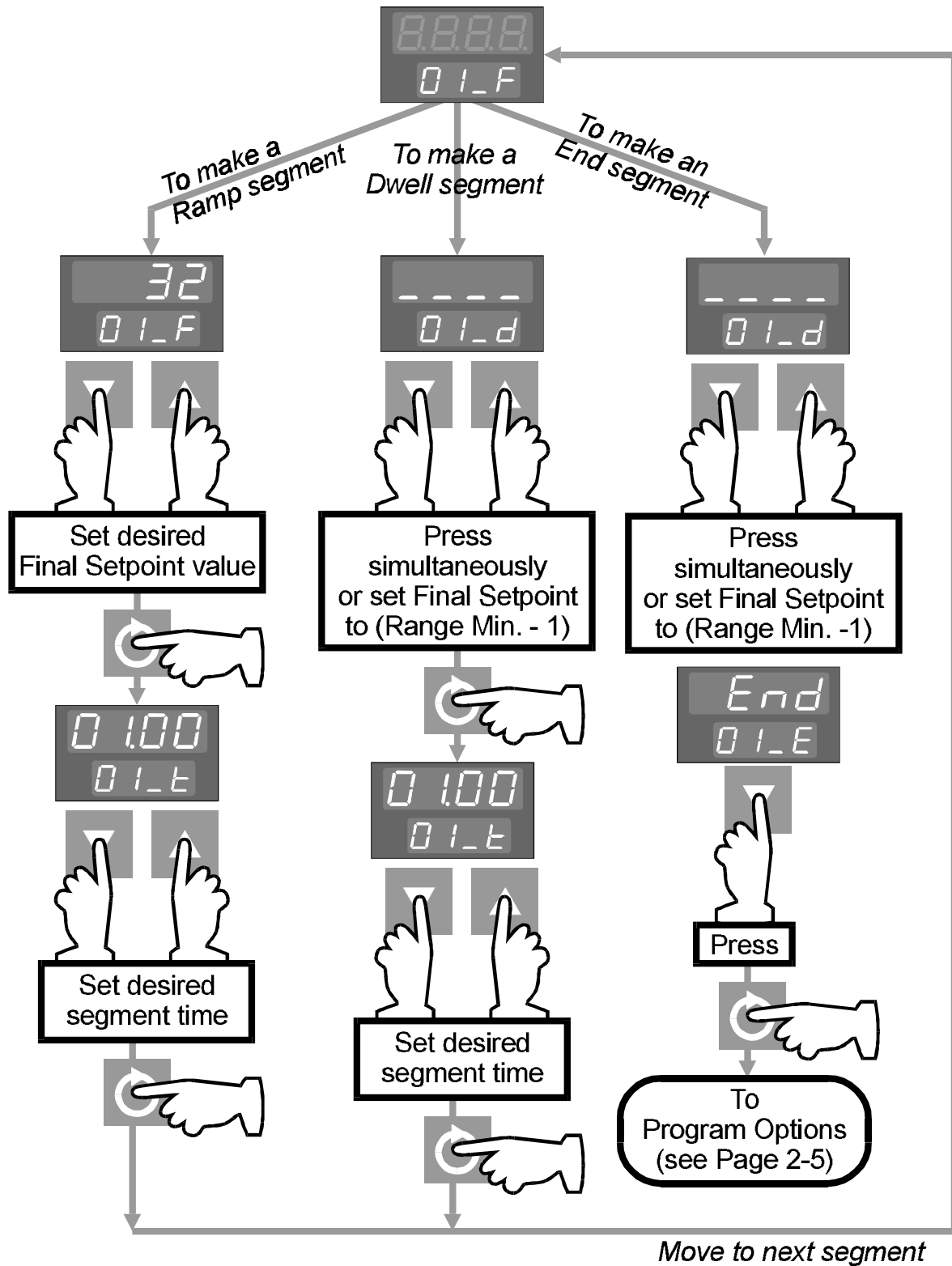

### 2.2.4 Program Options

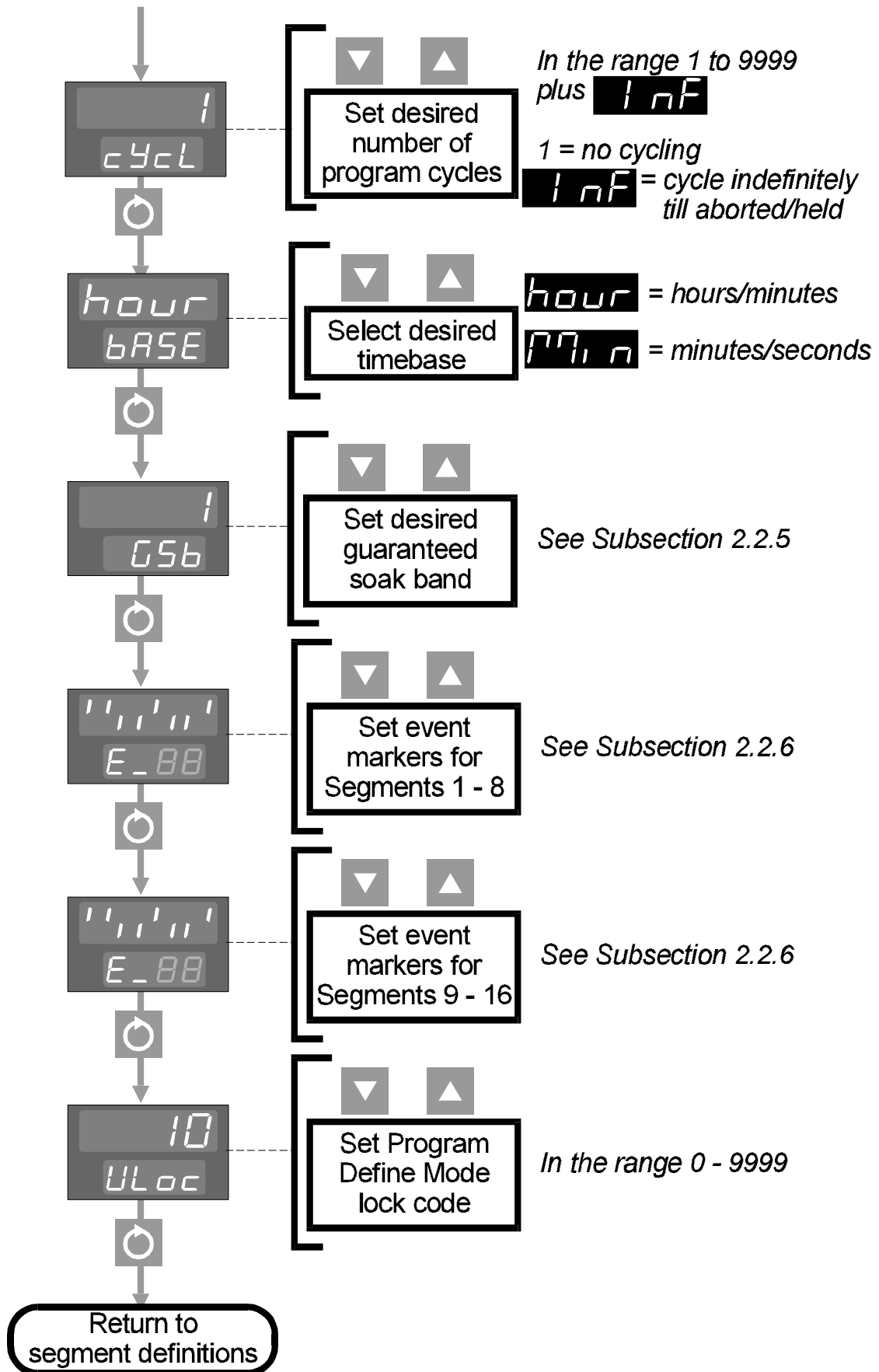



## 2.2.5 Guaranteed Soak Band

The Guaranteed Soak Band is applicable to Dwell segments only and operates as follows (depending on whether Guaranteed Soak has been enabled or Manual Guaranteed Soak has been configured):

### GUARANTEED SOAK ENABLED

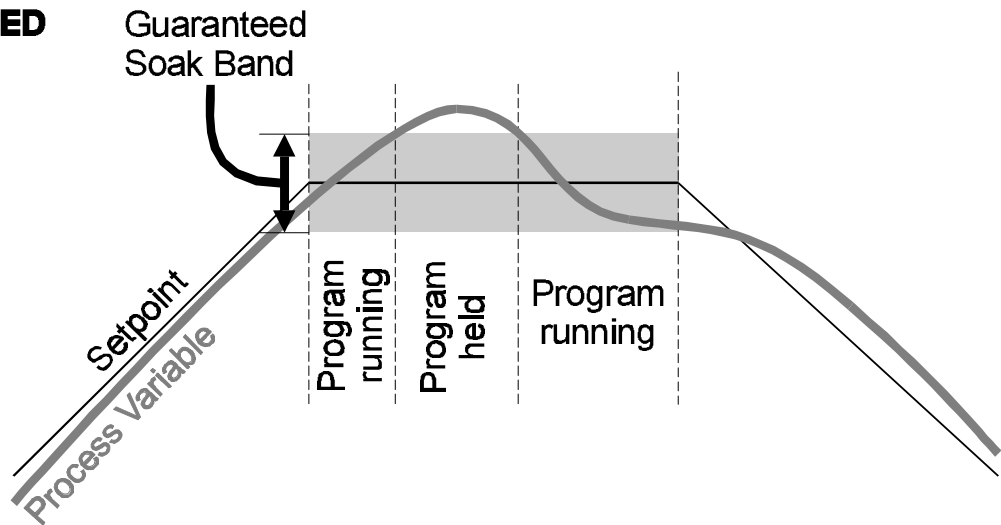

### MANUAL GUARANTEED SOAK

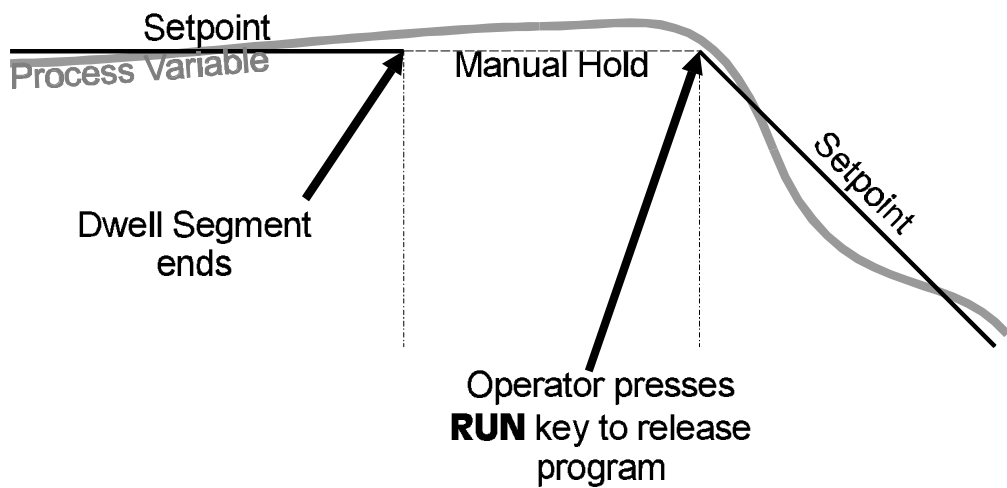

### 2.2.6 Segment Event Status

For every segment in a program there is an event indicator. This may be set ON or OFF for that segment. The status for the segments in the currently-selected program appears in the following form in the upper display:

DISPLAY 1

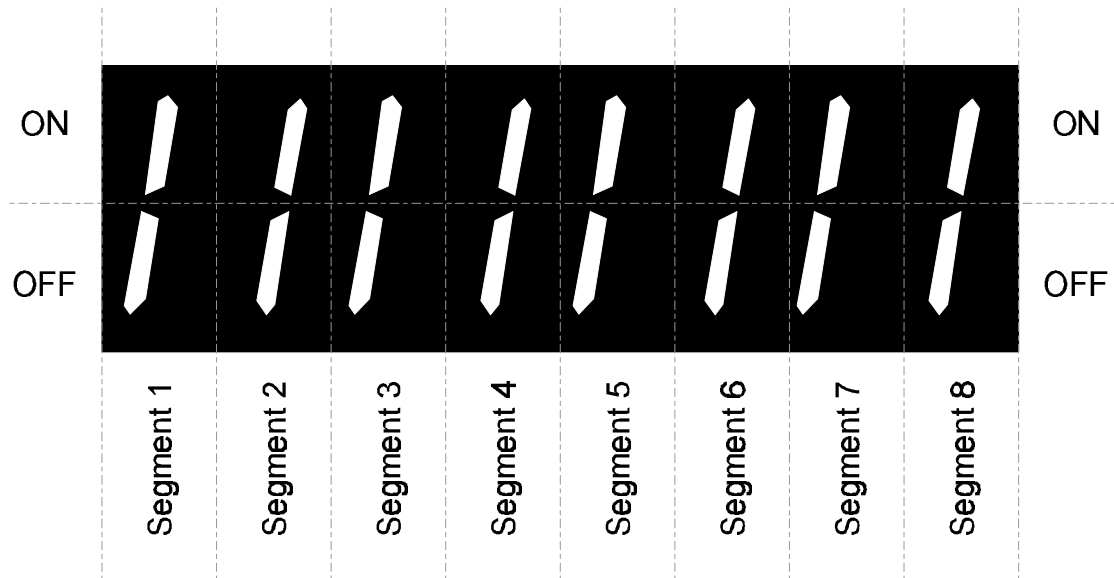

DISPLAY 2

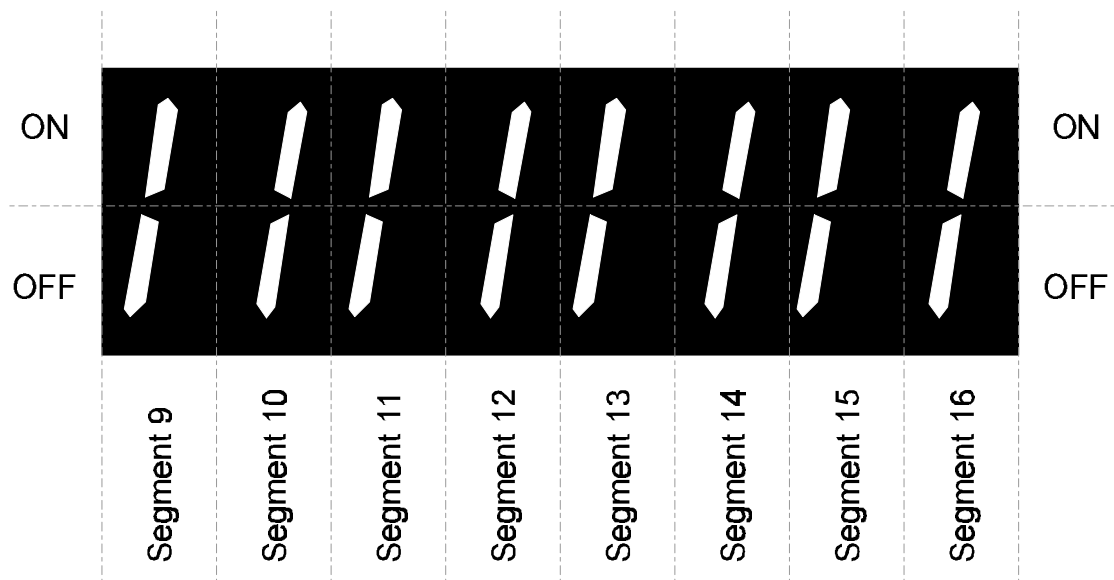

The first display shows the current event status for Segments 1 - 8 and the second display shows the current event status for Segments 9 - 16. Each event marker may be set ON (Up key) or OFF (Down key) in order of segment number. Only the event indicators for the segments in the program are displayed. If the program has less than 16 segments (including the End Segment), the non-applicable display positions are blank; if the program has eight segments or less, the second display is not included.. The lower display shows the current segment number. Thus, the key sequence to define the event markers for Segments 1 - 8 could be:

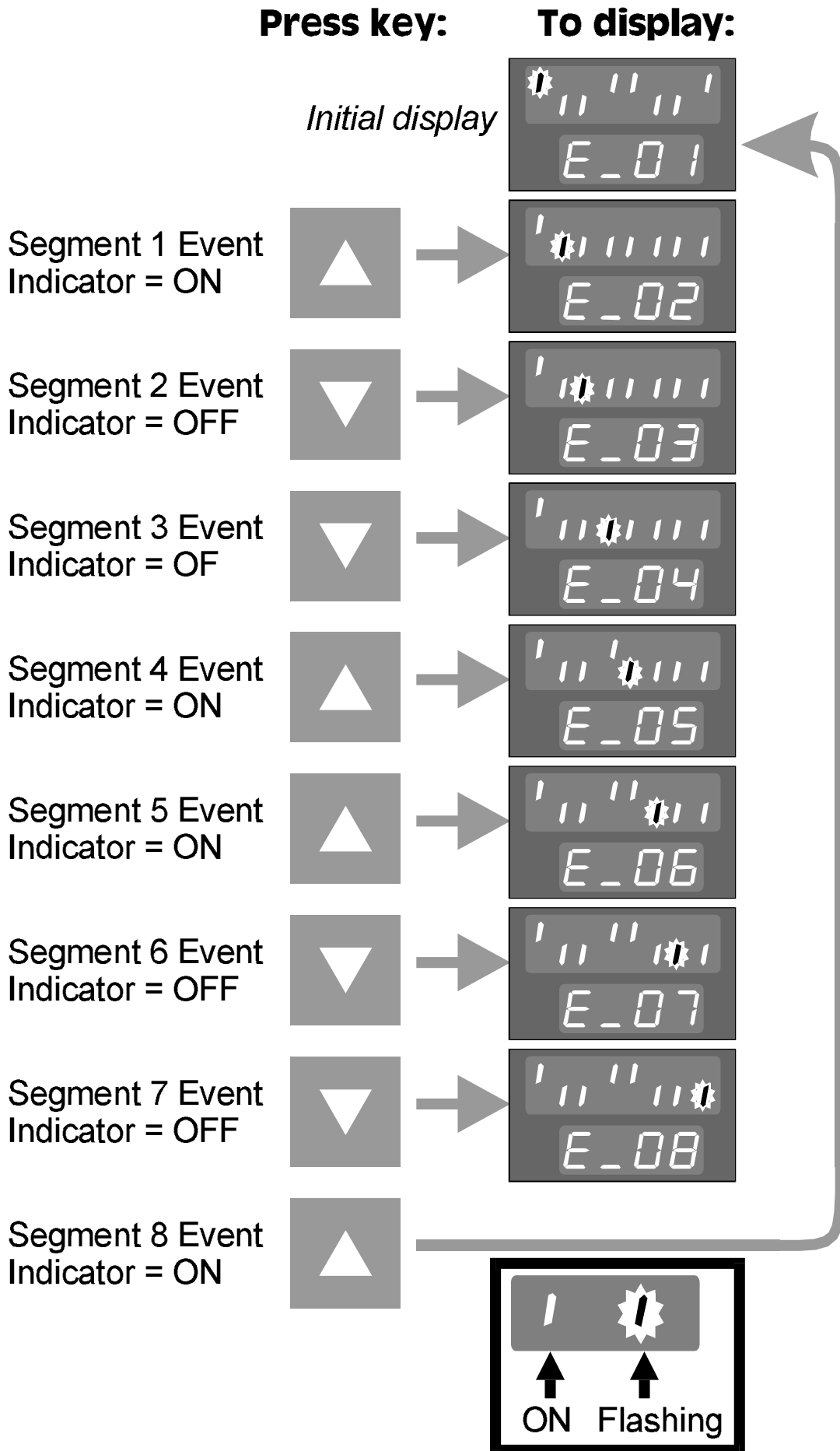

Pressing the Scroll key would then display the event markers for Segments 9 - 16 (as applicable), which could be defined in a similar manner.

### 2.3 DEFAULT VALUES AND ADJUSTMENT RANGES

Parameter	Range Minimum	Range Maximum	Default
Ramp Rate	0 = Dwell segment -1 = End segment	9999, then INF	100
Final (End of Ramp) Setpoint	Range Minimum	Range Maximum	Range Minimum
Segment Time	00:00	99:59	01:00
Number of Cycles	1	9999 then INF	1
Guaranteed Soak Band	1	Span plus OFF	OFF

### 2.4 EXIT FROM PROGRAM DEFINE MODE

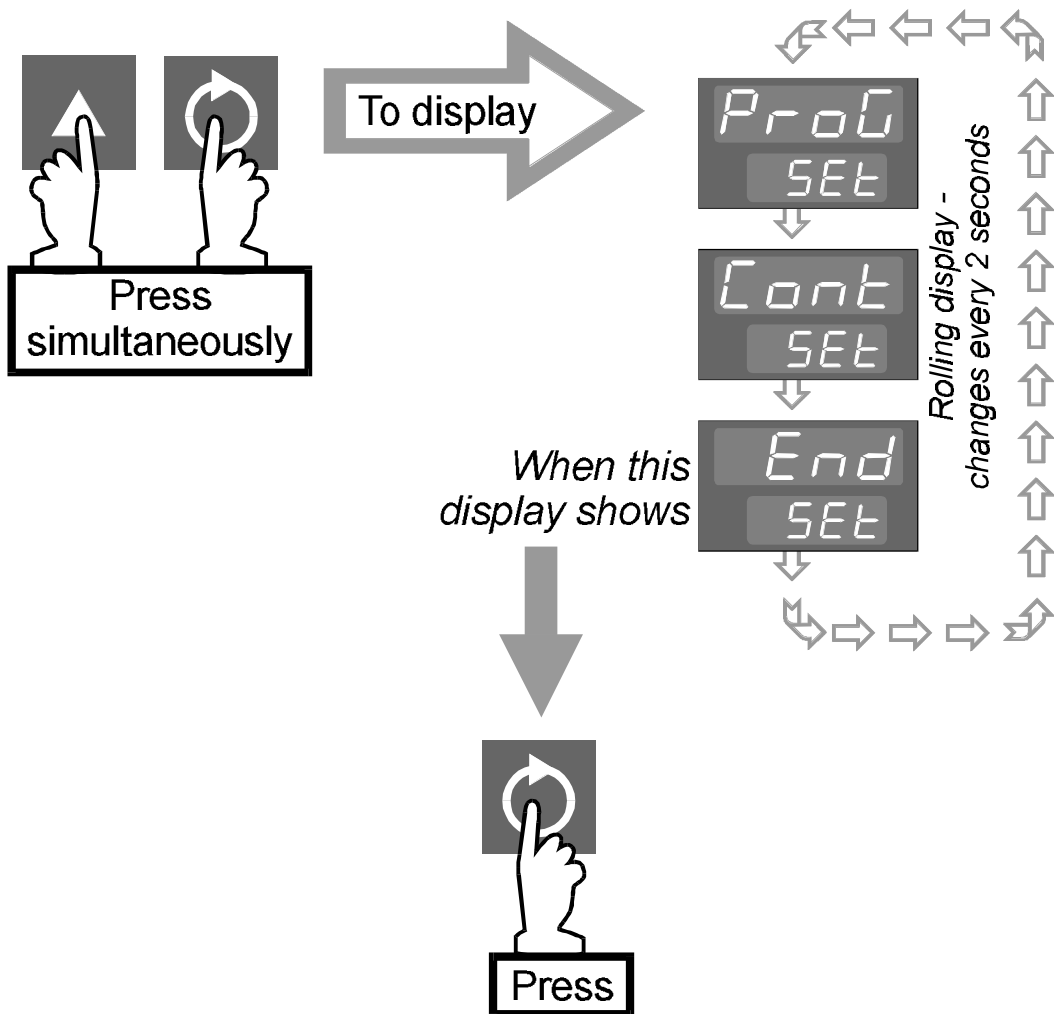

A return is then made to the normal Base Mode display.

### 3 CONTROLLER SET-UP MODE

In this mode, the parameters which define the operation of the controller are defined. Controller Set-Up Mode can be entered (whether or not there is a program currently running) as follows:

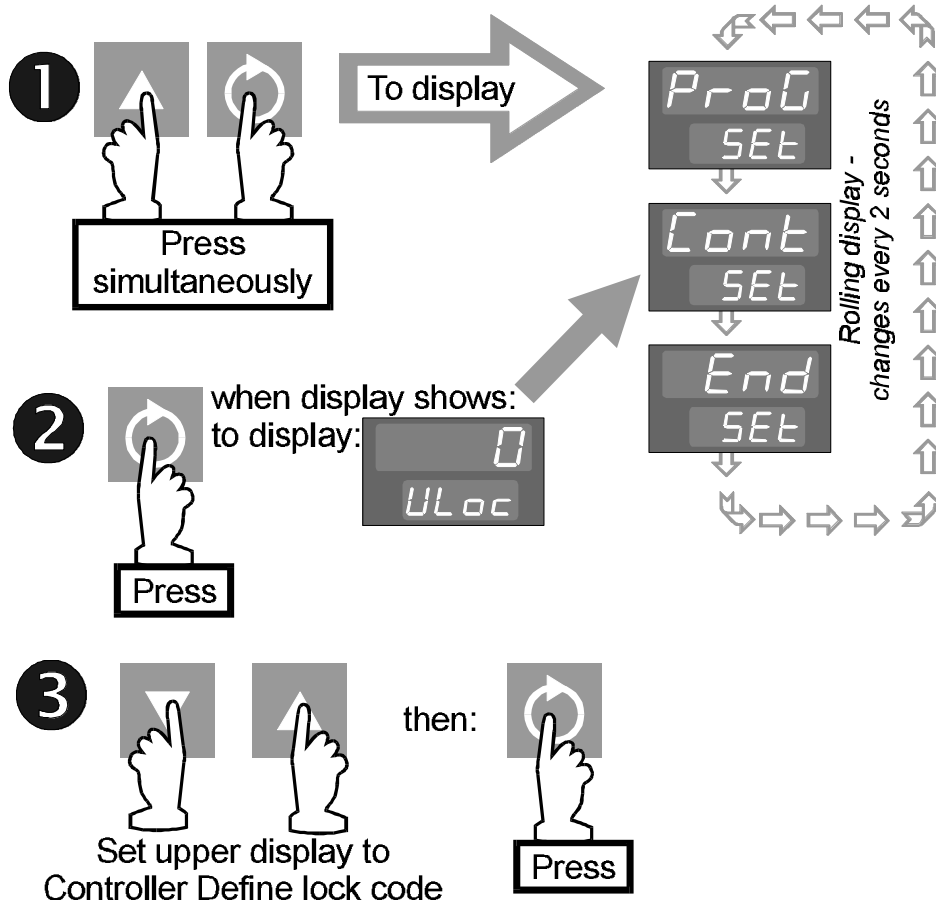

**NOTES:**

1. If the Controller Set-Up Mode lock code has been set to 0, pressing the Scroll key in Step 2 will give direct access to Controller Set-Up Mode; no entry of lock code is required.

2. If the upper display initially shows all decimal points illuminated (see right), one or more configuration parameters have been altered and, as a consequence, all ControllerSet Up Mode parameters have been automatically set to their default values/settings. To clear this display, simply alter the value/setting of any Controller Set Up Mode parameter.



Upon entry into Controller Set-Up Mode, the first in a sequence of controller parameters will be displayed. The operator may then step through the parameter sequence using the Scroll key, adjusting the setting/value of each displayed parameter using the Up/Down keys. The parameter sequence is as follows:

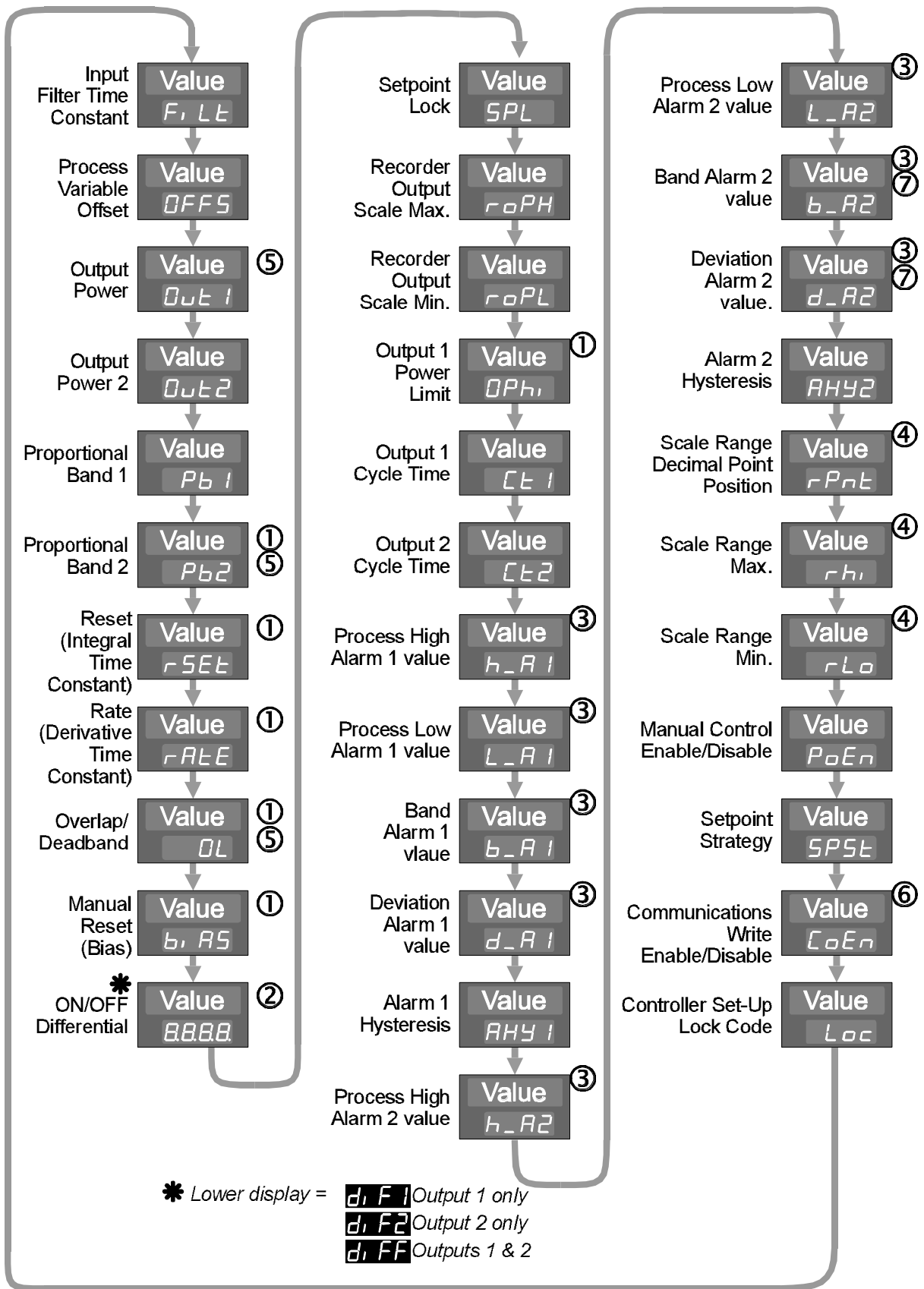

## NOTES

1. Not operative if Proportional Band = 0.
2. Switching differential for ON/OFF control output.
3. Optional; only one legend will appear for each alarm.
4. Only applicable if a DC linear input is fitted.
5. Only applicable if Output 2 is fitted as a secondary control (COOL) output.
6. Applicable only if the Communications Option is fitted.
7. When a program is running, respective to program setpoint.

### 3.1 PARAMETER DETAILS

Parameter	Function	Adjustment Range	Default value
Input Filter Time Constant	Filter removes extraneous impulses from the process variable input	OFF, 0.5 to 100.0 seconds in 0.5 second increments	2.0 seconds
Process Variable Offset	Modifies actual process variable (PV) value: Offset PV + actual PV = PV value used	±input span of Controller	0
Output Power 1	Current Output 1 power level	0 to 100%	Read only
Output Power 2	Current Output 2 power level	0 to 100%	Read only
Proportional Band 1 (PB1)	Portion of input span in which Output 1 power level is proportional to the (offset) process variable value (see Figure 3-1).	0.0 to 999.9% of input span	10.0%
Proportional Band 2 (PB2)	Portion of input span in which Output 2 power level is proportional to the (offset) process variable value (see Figure 3-1).	0.0 to 999.9% of input span	10.0%
Reset (Integral Time Constant)	Integral time constant	1sec. to 99min. 59 secs. and OFF	5 mins. 00 secs.
Rate (Derivative Time Constant)	Derivative time constant	00 secs. to 99 mins. 59 secs.	1 min. 15 secs.
Overlap/Deadband	Portion of proportional band (PB1 + PB2) in which both outputs are active (overlap) or neither output is active (deadband) - see Figure 3-1).	-20% to +20% of (Proportional Band 1 + Proportional Band 2)	0%
Manual Reset (Bias)	Bias applied to output power, expressed as a percentage of output power.	0% to 100% (Output 1 only); -100% to +100% (Output 1 & Output 2)	25%

Parameter	Function	Adjustment Range	Default value
ON/OFF Differential	Switching differential for one output or both outputs set to ON/OFF control (PB1, PB2 or both = 0) - see Figure 3-1.	0.1% to 10.0% of input span	0.5%
Setpoint Lock	Enables/disables setpoint (SP) adjustment in Base Mode.	OFF - SP adjustable ON - SP not adjustable	OFF
Recorder Output Scale Maximum	Process variable or setpoint value (as applicable) for which the recorder output is a maximum	-1999 to 9999 (decimal point position as for input range)	Input Range Maximum
Recorder Output Scale Minimum	Process variable or setpoint value (as applicable) for which the recorder output is a minimum	-1999 to 9999 (decimal point position as for input range)	Input Range Minimum
Output 1 Power Limit	Limits Output 1 power level (to protect the process)	0% to 100% of full power	100%
Output 1 Cycle Time	Limits the frequency of operation of output relay to maximise relay life	0.5, 1, 2, 4, 8, 16, 32, 64, 128, 256 or 512 secs.	32 secs.
Output 2 Cycle Time	Limits the frequency of operation of output relay to maximise relay life	0.5, 1, 2, 4, 8, 16, 32, 64, 128, 256 or 512 secs.	32 secs.
Process High Alarm 1	If Alarm 1 is a Process High Alarm, the value of the process variable at or above which Alarm 1 will be active (see Figure 3-2)	Input Range Minimum to Input Range Maximum	Input Range Maximum
Process Low Alarm 1	If Alarm 1 is a Process Low Alarm, the value of the process variable at or below which Alarm 1 will be active (see Figure 3-2)	Input Range Minimum to Input Range Maximum	Input Range Minimum
Band Alarm 1	If Alarm 1 is a Band Alarm, the band of process variable values, centred on the (program) setpoint, outside which the process variable will cause this alarm to be active (see Figure 3-2)	0 to input span from (program) setpoint	5 units
Deviation Alarm 1	If Alarm 1 is a Deviation Alarm, gives a value above (positive value) or below (negative value) the (program) setpoint. If the process variable deviates from the setpoint by a margin greater than this value, the alarm becomes active (see Figure 3-2)	$\pm$ input span from (program) setpoint	5 units
Alarm 1 Hysteresis	Defines a hysteresis band on the safe side of the Alarm 1 value	1 to 250 units	1 unit



Parameter	Function	Adjustment Range	Default value
Process High Alarm 2	If Alarm 2 is a Process High Alarm, the value of the process variable at or above which Alarm 2 will be active (see Figure 3-2)	Input Range Minimum to Input Range Maximum	Input Range Maximum
Process Low Alarm 2	If Alarm 2 is a Process Low Alarm, the value of the process variable at or below which Alarm 2 will be active (see Figure 3-2)	Input Range Minimum to Input Range Maximum	Input Range Minimum
Band Alarm 2	If Alarm 2 is a Band Alarm, the band of process variable values, centred on the (program) setpoint, outside which the process variable will cause this alarm to be active (see Figure 3-2)	0 to input span from (program) setpoint	5 units
Deviation Alarm 2	If Alarm 2 is a Deviation Alarm, gives a value above (positive value) or below (negative value) the (program) setpoint. If the process variable deviates from the setpoint by a margin greater than this value, the alarm becomes active (see Figure 3-2)	$\pm$ input span from (program) setpoint	5 units
Alarm 2 Hysteresis	Defines a hysteresis band on the safe side of the Alarm 2 value	1 to 250 units	1 unit
Scale Range Decimal Point Position	For linear inputs only, defines the decimal point position	0 (xxxx), 1 (xxx.x), 2 (xx.xx) or 3 (x.xxx)	1 (xxx.x)
Scale Range Maximum	For linear inputs only, defines the scaled input value when the process variable input is at its maximum value	-1999 to 9999	1000
Scale Range Minimum	For linear inputs only, defines the scaled input value when the process variable input is at its minimum value	-1999 to 9999	0000
Manual Control Enable/Disable		0 (Disabled) or 1 (Enabled)	0 (Disabled)
Setpoint Strategy	Determines whether or not the setpoint is adjustable in the normal Base Mode display	0 = not adjustable, 1 = adjustable	1
Communications Enable/Disable	Enables/disables changing of parameter values via the communications link	0 (disabled) or 1 (Enabled)	1 (Enabled)
Controller Set-Up Mode Lock Code	Defines the four-digit code required to enter the Controller Set-Up Mode	0 to 9999	10

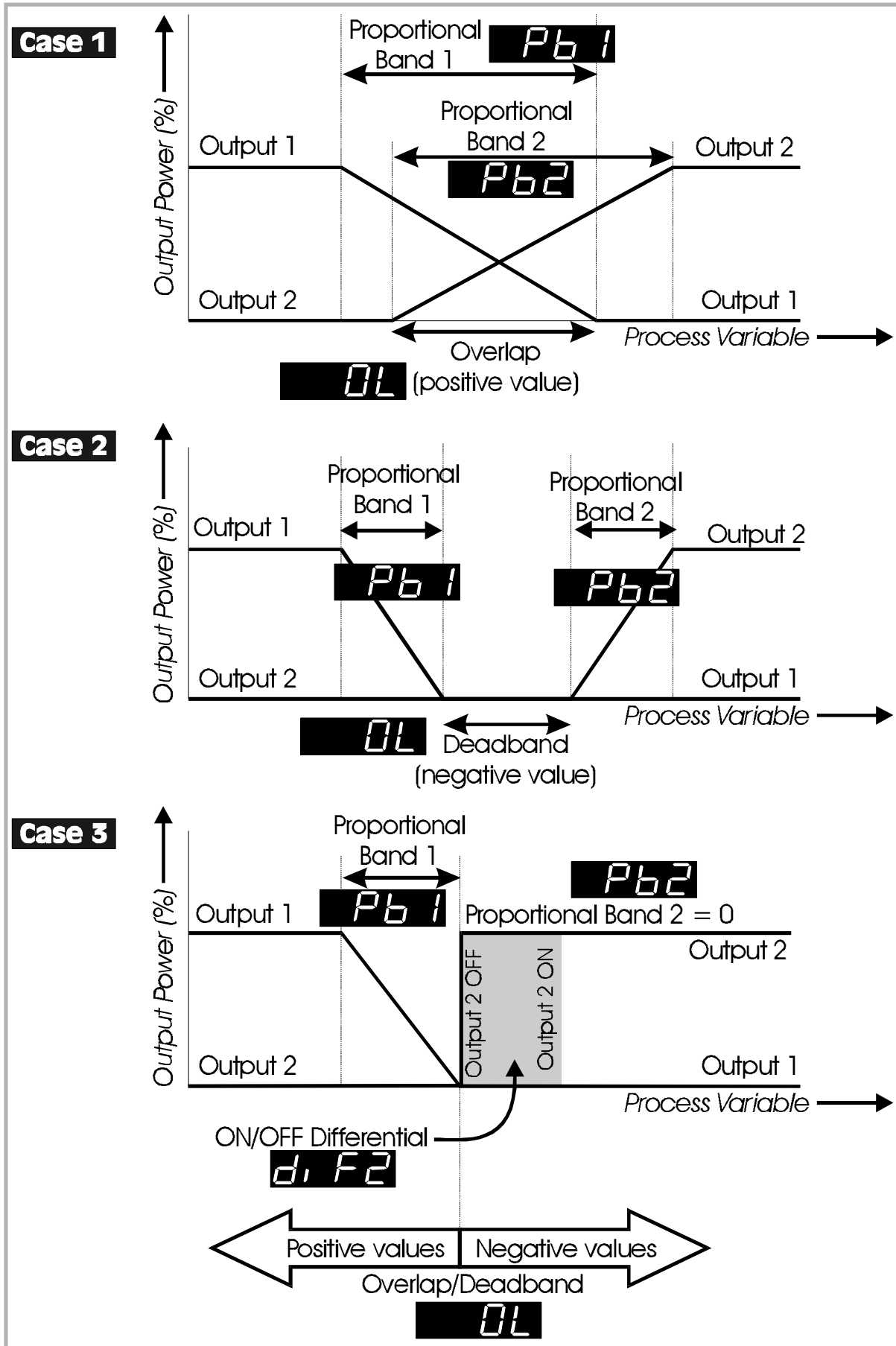

Figure 3-1 Proportional Band and Overlap/Deadband

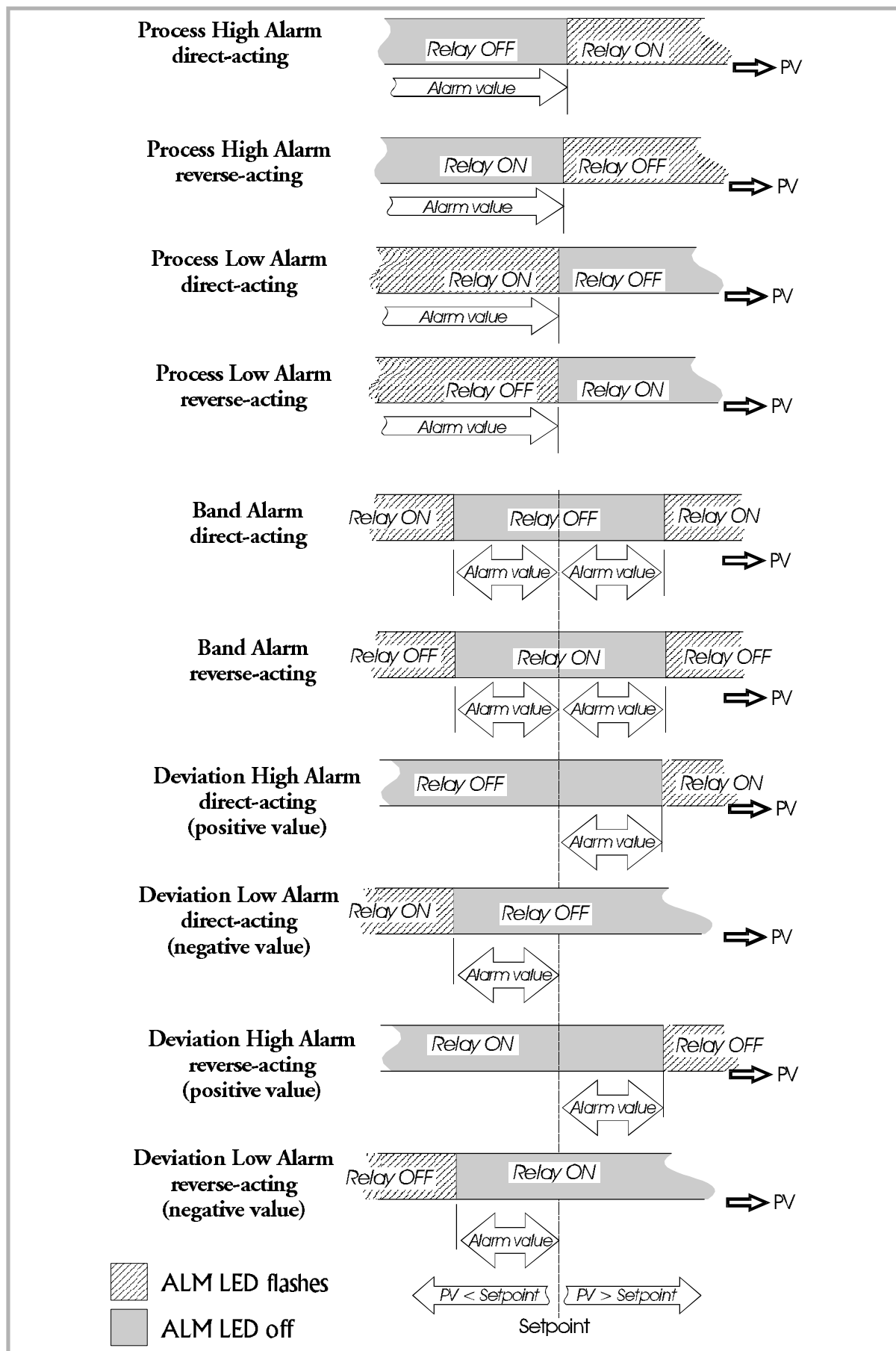

Figure 3-2 Alarm Operation

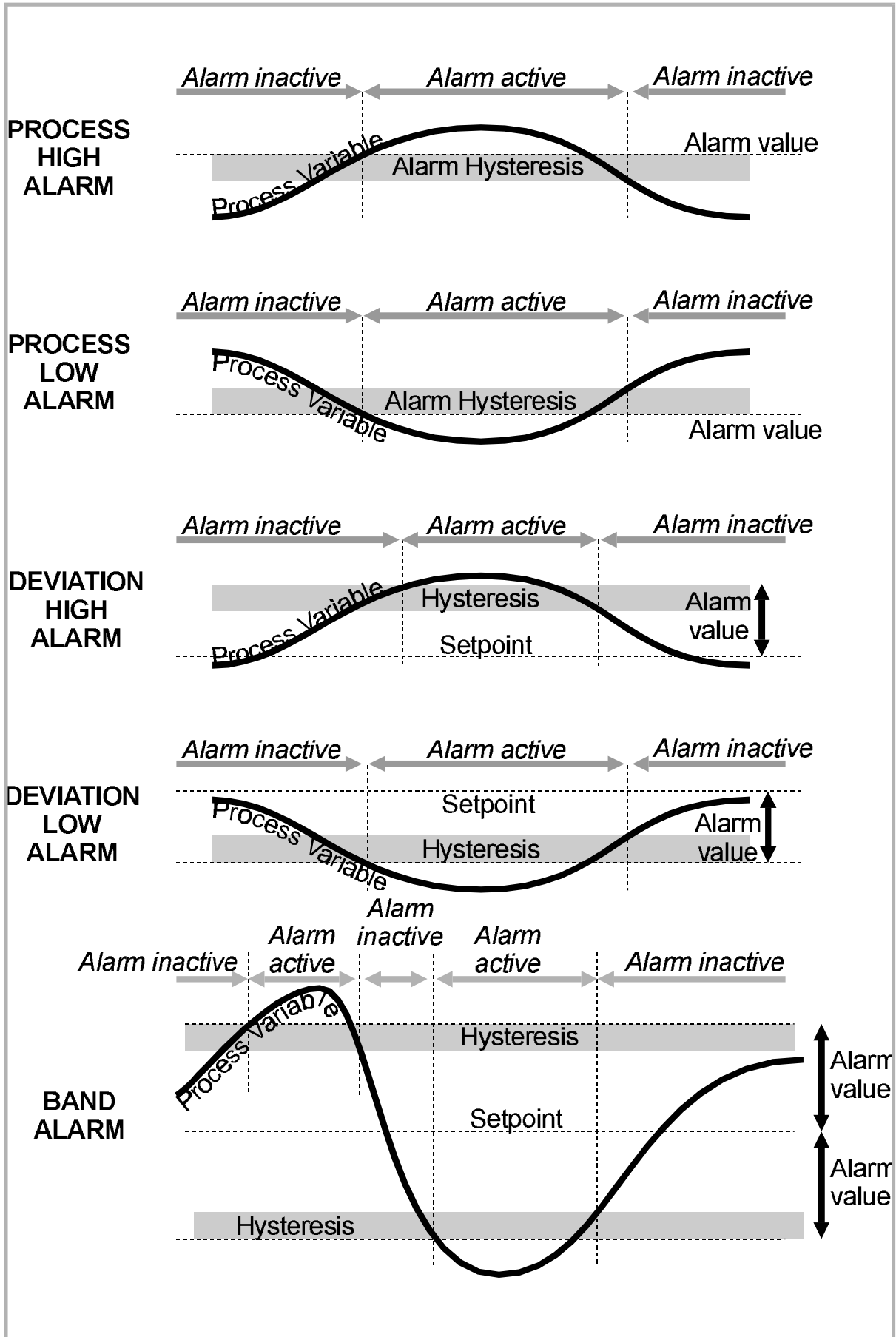
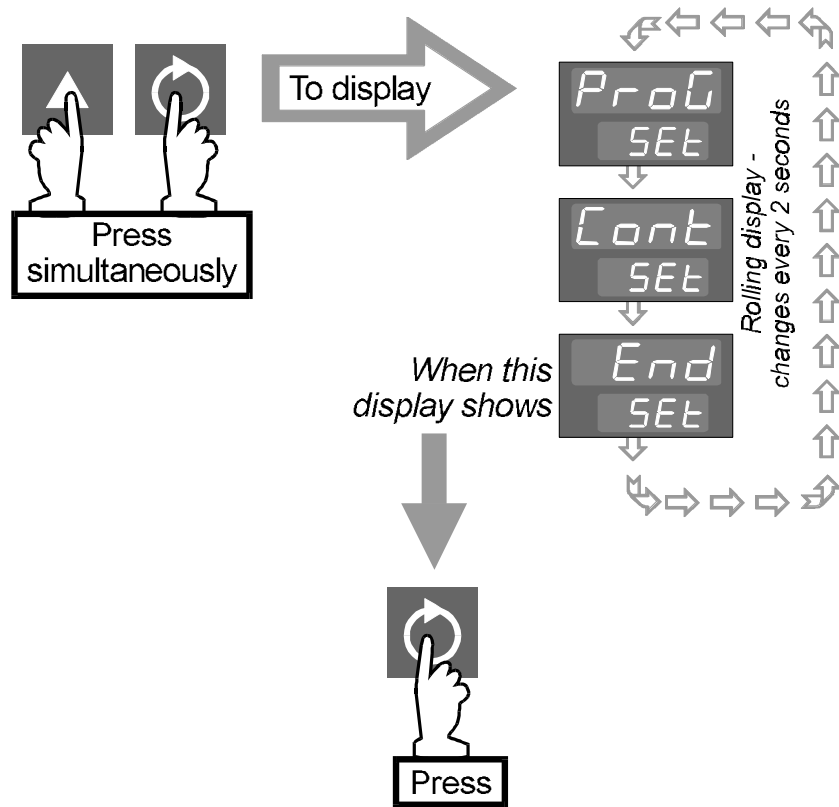

Figure 3-3 Alarm Hysteresis Operation

### 3.2 EXIT FROM CONTROLLER SET-UP MODE



A return will then be made to the normal Base Mode display.

## 4 MODBUS COMMUNICATIONS

### 4.1 INTRODUCTION

This Section specifies the MODBUS communications protocol as implemented on the  $\frac{1}{16}$ -DIN Profiler/Controller.

Certain restrictions have been imposed upon this implementation:

- (i) Baud rates may be set to 1200, 2400, 4800 and 9600 only
- (ii) Support for multi-parameter Writes is limited to support of the Multi-word Write Function (Number 16) but will permit writing of one parameter only per message
- (iii) The multi-parameter Read function supports a maximum of 10 parameters in one message.

### 4.2 MODBUS FUNCTIONS SUPPORTED

In the following list, the original Gould MODBUS function names have been used, followed by the JBUS names in italics, where such an equivalence exists. The MODBUS Function number follows the names.

A	Read Coil Status ( <i>Read n Bits</i> )	01/02
B	Read Holding Registers ( <i>Read n Words</i> )	03/04
C	Force Single Coil ( <i>Write 1 Bit</i> )	05
D	Preset Single Register ( <i>Write 1 Word</i> )	06
E	Loopback Diagnostic Test	08
F	Preset Multiple Registers ( <i>Write n Words</i> )	16

The instrument will identify itself in reply to a Read Holding Registers message which enquires the values of parameter numbers 121 & 122, as specified in the CNOMO documentation, and MODBUS Function 17 (Report Slave ID) will not be supported.

### 4.3 MESSAGE FORMATS

The first character of every message is an instrument address. The valid range of such an address is 0 to 255. The second character is always the Function

Number. The contents of the remainder of the message depends upon the function number.

In most cases the instrument is required to reply by echoing the address and function number, together with an echo of all or part of the message received (in the case of a request to write a value or carry out a command) or the information requested (in the case of a read parameter operation). Broadcast Messages (to which the controller responds by taking some action without sending back a reply) are supported at instrument address zero. Commands which can be broadcast are marked with the symbol **B**.

Data is transmitted as eight-bit binary bytes with 1 start bit, 1 stop bit and optional parity checking (None, Even or Odd).

A message is terminated solely by a delay of more than three character lengths at the given Baud Rate, and any character received after such a delay is treated as a potential address at the start of a new message.

The following individual message formats apply. Since only the RTU form of the protocol is being supported, each message is followed by a two-byte CRC16. Details of how the checksum must be calculated are given at the end of this section.

**A. Read Coil Status (*Read n Bits*) 01/02**

The message sent to the controller will consist of 8 bytes, as follows:

<b>Addr.</b>	<b>Func.</b>	<b>Addr. of 1st Bit</b>		<b>No. of bits</b>		<b>CRC16</b>	
		<i>HI</i>	<i>LO</i>	<i>HI</i>	<i>LO</i>	<i>HI</i>	<i>LO</i>
	<i>1/2</i>						

The normal reply will echo the first two characters of the message received, and will then contain a single-byte data byte count, which will not include itself or the CRC. For this message, there will be one byte of data per eight bits-worth of information requested, with the LSbit of the first data byte transmitted depicting the state of the lowest-numbered bit required.

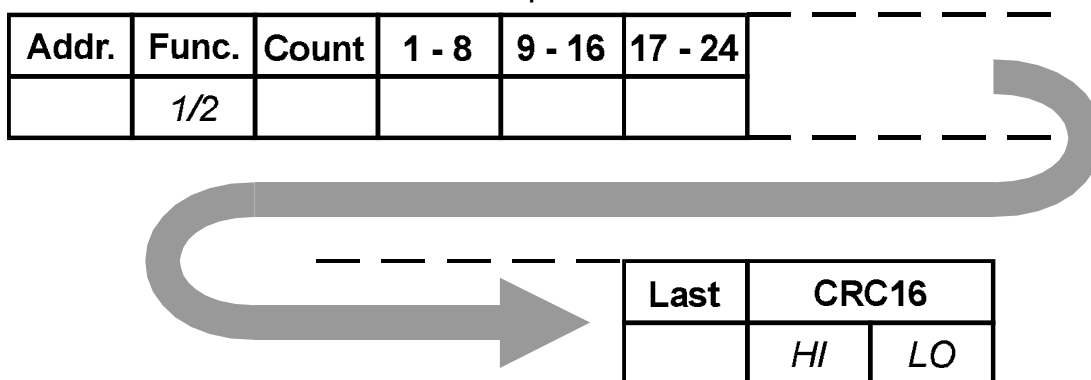

This function will be used largely to report controller status information, and so a bit set to 1 indicates that the corresponding feature is currently enabled/active, and a bit reset to 0 indicates the opposite.

If an exact multiple of eight bits is not requested, the data is padded with trailing zeros to preserve the 8-bit format. After the data has been transmitted, the CRC16 value is sent.

**B. Read Holding Registers (*Read n Words*) 03/04**

The message sent to the controller to obtain the value of one or more registers is an eight-byte message as follows:

Addr.	Func.	Addr. of 1st Word		No. of words		CRC16	
		HI	LO	HI	LO	HI	LO
	3/4						

The reply sent by the controller echoes the first 2 characters received and then contains a single-byte data byte count, the value of which does not include either itself or the CRC value to be sent. For this message, the count equals the number of parameters read times two. Following the byte count, that number of parameter values are transmitted, MSB first, followed by the CRC16.

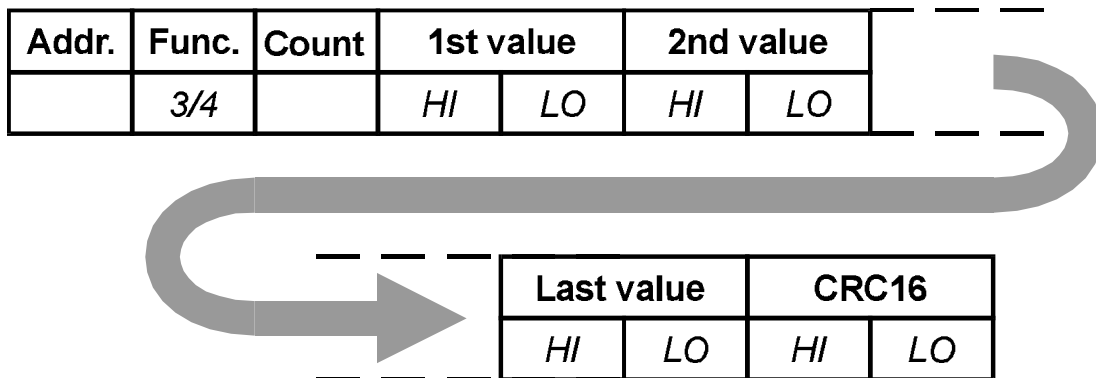

**C. Force Single Coil (*Write 1 Bit*) 05 B**

The message received by the controller is 8 bytes long, consisting of the standard preamble and the address of the bit to force, followed by a two-byte word whose MSB contains the desired truth value of the bit expressed as 0xFF (TRUE) or 0x00 (FALSE).

Addr.	Func.	Addr. of Bit		State		CRC16	
		HI	LO	FF/00	0	HI	LO
	5						

Generally, this function will be used to control such features as Auto/Manual and Tuning.

The normal reply sent by the controller will be a byte-for-byte echo of the message received.



**D. Preset Single Register (*Write 1 Word*) 06 B**

The message sent to the controller consists of 8 bytes: the address and function number as usual, the address of the parameter to be written, and the two-byte value to which the parameter will be set, and finally the CRC16.

Addr.	Func.	Addr. of Word		Value		CRC16	
	6	HI	LO	HI	LO	HI	LO

The normal response is to echo the message in its entirety.

**E. Loopback Diagnostic Test 08**

The controller is sent an 8 byte message consisting of the usual preamble, a two-byte diagnostic code, and two bytes of data, followed by the CRC16.

Addr.	Func.	Diag. Code		Value		CRC16	
	8	HI	LO	HI	LO	HI	LO

Full MODBUS support in this area is not appropriate - consequently, the only Diagnostic Code supported is code 00. In response to the message, the controller must echo the message received exactly.

**F. Preset Multiple Registers (*Write n Words*) 16 B**

This message consists of eleven bytes. Only one parameter may be written at a time, even though this function number is supported. The preamble is followed by the address of the parameter to be written, and then a two-byte word count (always set to 1) and a single-byte byte count (always set to 2). Finally, the value to be written is followed by the CRC16.

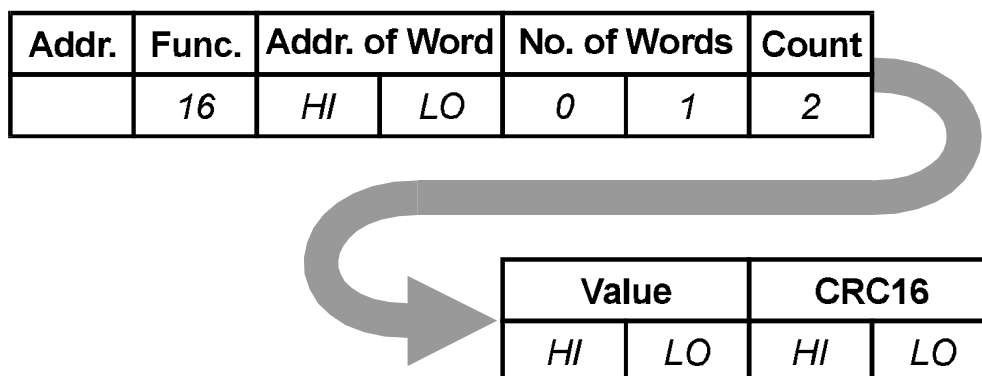

The controller normally responds with a eight-byte reply, as follows:

Addr.	Func.	Addr. of Word		No. of Words		CRC16	
	16	HI	LO	0	1	HI	LO

## G. Error and Exception Responses

If the controller receives a message which contains a corrupted character (parity check fail, framing error etc), or if the CRC16 check fails, the controller ignores the message. If the message is otherwise syntactically flawed (e.g. the byte count or word count is incorrect) the controller will also not reply.

However, if the controller receives a syntactically correct message which nonetheless contains an illegal value, it will send an exception response, consisting of five bytes as follows:

Addr.	Func.	Exception No.	CRC16	
			HI	LO

The Function Number field consists of the function number contained in the message which caused the error, with its top bit set (i.e. function 3 becomes 0x83), and the Exception Number is one of the codes contained in the following table:

Code	Name	Cause
1	ILLEGAL FUNCTION	Function Number out of range
2	ILLEGAL DATA ADDRESS	Parameter ID out of range or not supported
3	ILLEGAL DATA VALUE	Attempt to write invalid data/action not carried out
4	DEVICE FAILURE	N/A
5	ACKNOWLEDGE	N/A
6	BUSY	N/A
7	NEGATIVE ACKNOWLEDGE	N/A

## H. CRC16 Calculation

This is a 16-bit cyclic redundancy checksum. It is calculated in accordance with a formula which involves recursive division of the data by a polynomial, with the input to each division being the remainder of the results of the previous one.

The formula specifies that input is treated as a continuous bit-stream binary number, with the most significant bit being transmitted first. However, the transmitting device sends the least significant bit first.

According to the formula, the dividing polynomial is  $2^{16} + 2^{15} + 2^2 + 1$  (Hex 18005), but this is modified in two ways:

- i. Because the bit-order is reversed, the binary pattern is reversed also, making the MSB the rightmost bit, and

- ii. Because only the remainder is of interest, the MSB (the right-most bit) may be discarded.

This means the polynomial has the value Hex A001. The CRC algorithm is as follows:

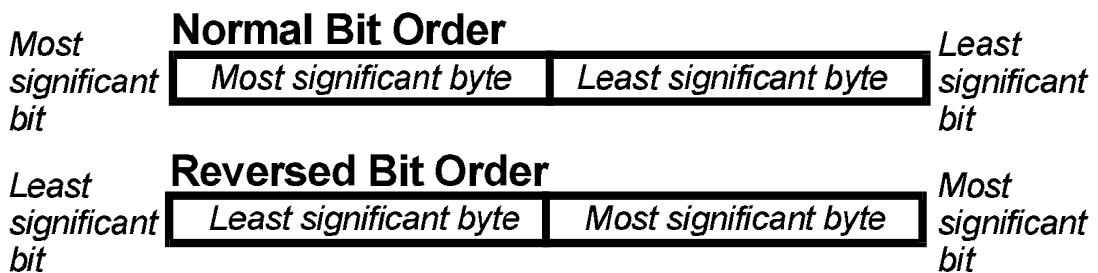
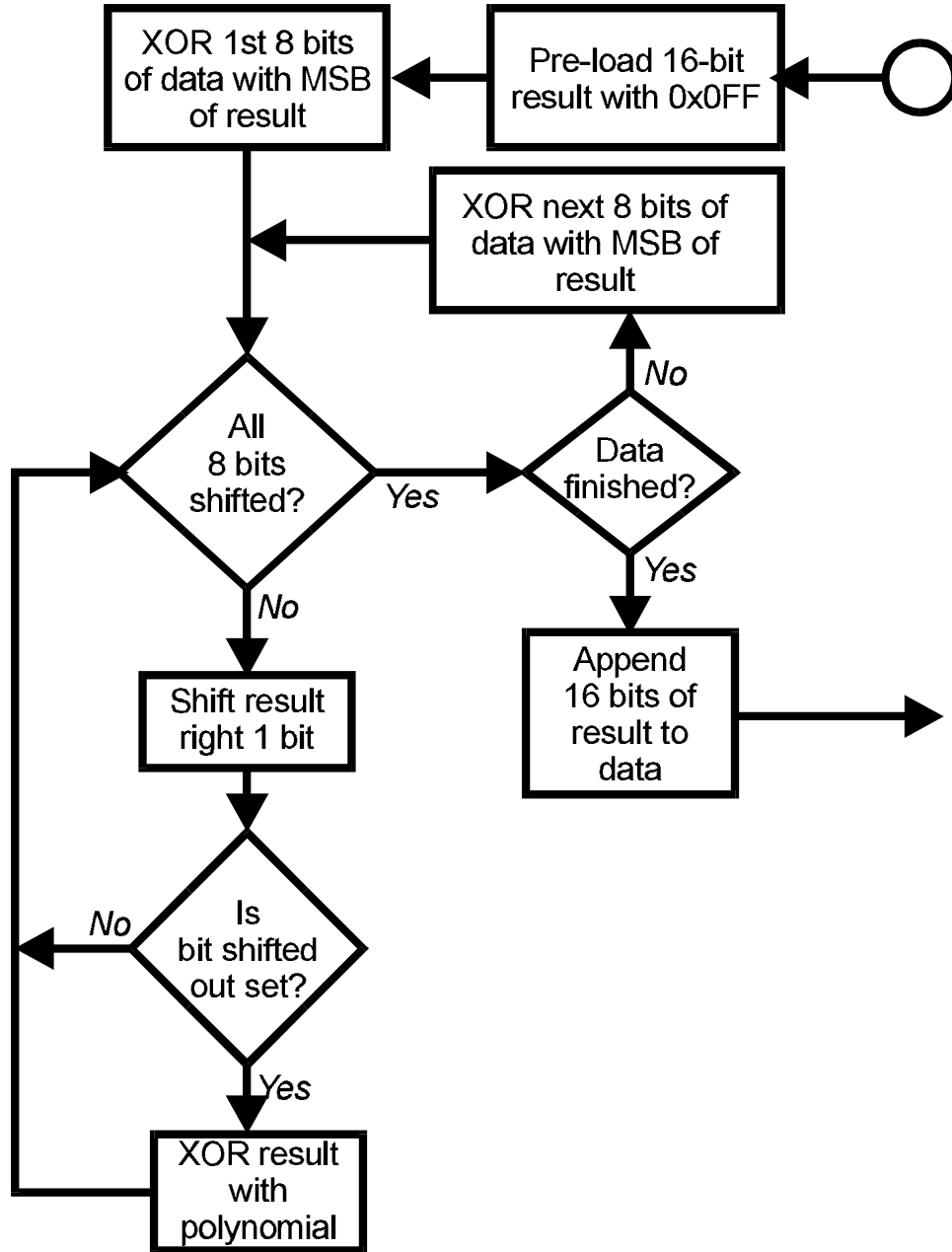

**REVERSED BIT ORDER USED**

## 4.4 PARAMETER NUMBERS

The parameter numbering system, in order to conform to the CNOMO standard, splits parameters into BITS and WORDS and numbers each group independently.

### A. Bit Parameters (Controller Status Byte)

There are a maximum of sixteen of these:

No.	Parameter	Notes
1	Communications Write Status	Read only - 1 = enabled, 0 = disabled
2	Auto/Manual Control	1 = Manual, 0 = Auto
3	RaPID Tuning Status	1 = active, 0 = inactive
4	Pre-Tune Status	1 = active, 0 = inactive
5	Alarm 1 Status	Read only - 1 = active, 0 = inactive
6	Alarm 2 Status	Read only - 1 = active, 0 = inactive
7	Over-range Flag	Read only - 1 = active, 0 = inactive
8	Under-range Flag	Read only - 1 = active, 0 = inactive
9	Sensor Break Flag	Read only - 1 = break, 0 = no break
10	Reserved	
11	Reserved	
12	Reserved	
13	Reserved	
14	Reserved	
15	Reserved	
16	Reserved	

## B. Word Parameters

No.	Parameter	Notes
<b>Controller Parameters</b>		
1	Process Variable	Read only
2	Setpoint	Current setpoint, if ramping
3	Output Power	Read only, unless in Manual Control
4	Arithmetic Deviation	Read only
5	Proportional Band 2	
6	Proportional Band 1	
7	Controller Status	
8	Reset	
9	Rate	
10	Output 1 Cycle Time	
11	Scale Range Low	Read only if non-linear input
12	Scale Range High	Read only if non-linear input
13	Alarm 1 value	
14	Alarm 2 value	
15	Manual Reset	
16	Overlap/Deadband	
17	ON/OFF Differential	
18	Decimal Point Position	Read only if non-linear input
19	Output 2 Cycle Time	
20	Output 1 Power Limit	
21	Setpoint Lock	0 = Off, 1 = On
22	Reserved	
23	Filter Time Constant	
24	Process Variable Offset	
25	Recorder Output Max.	
26	Recorder Output Min.	
27	Alarm 1 Hysteresis	
28	Alarm 2 Hysteresis	
<b>Program Parameters</b>		
29	Segment Mode	0 = Rate, 1 = Time
30	Profiler Status	Read only - see Subsection 4.5.
31	Current Program Number	Read only
32	Current Segment Number	Read only in current running/held program
33	Segment Time Remaining	Read only

No.	Parameter	Notes
34	Profiler Commands	Write only - see Subsection 4.6.
35	Power Fail Recovery	0 = Cold start, 1 = Warm start
36	Guaranteed Soak Type	0 = disabled, 1 = enabled, 2 = manual
37	Cycles Remaining	Read only
<b>Instrument ID Parameters</b>		
121	Manufacturer ID	Read only - 231
122	Equipment ID	Read only - 6400
<b>Segment Parameters - Program 1</b>		
1100	Run Program (value = Delayed Start value)	Write only
1101	No. of Cycles Programmed	1 to 9999 plus 10000 (INF)
1102	Timebase	0 = hours/minutes, 1 = minutes/seconds
1103	Guaranteed Soak Band value	0 (OFF), 1 to span
1104 to 1119	Final Setpoint values (Dwell = -32768, End = -16384)	Segment 1 at address 1104 ↓ Segment 16 at address 1119
1120 to 1135	Rate values (Dwell = -32768, End = -16384)	Segment 1 at address 1120 ↓ Segment 16 at address 1135
1136 to 1151	Time values	Segment 1 at address 1136 ↓ Segment 16 at address 1151
1152	Event Marker settings	Bit 0 = Event 16 ⇒ Bit 15 = Event 1
<b>Segment Parameters - Program 2</b>		
1200	Run Program (value = Delayed Start value)	Write only
1201	No. of Cycles Programmed	1 to 9999 plus 10000 (INF)
1202	Timebase	0 = hours/minutes, 1 = minutes/seconds
1203	Guaranteed Soak Band value	0 (OFF), 1 to span
1204 to 1219	Final Setpoint values (Dwell = -32768, End = -16384)	Segment 1 at address 1204 ↓ Segment 16 at address 1219
1220 to 1235	Rate values (Dwell = -32768, End = -16384)	Segment 1 at address 1220 ↓ Segment 16 at address 1235
1236 to 1251	Time values	Segment 1 at address 1236 ↓ Segment 16 at address 1251
1252	Event Marker settings	Bit 0 = Event 16 ⇒ Bit 15 = Event 1

No.	Parameter	Notes
<b>Segment Parameters - Program 3</b>		
1300	Run Program (value = Delayed Start value)	Write only
1301	No. of Cycles Programmed	1 to 9999 plus 10000 (INF)
1302	Timebase	0 = hours/mnutes, 1 = minutes/seconds
1303	Guaranteed Soak Band value	0 (OFF), 1 to span
1304 to 1319	Final Setpoint values (Dwell = -32768, End = -16384)	Segment 1 at address 1304 ↓ Segment 16 at address 1319
1320 to 1335	Rate values (Dwell = -32768, End = -16384)	Segment 1 at address 1320 ↓ Segment 16 at address 1335
1336 to 1351	Time values	Segment 1 at address 1336 ↓ Segment 16 at address 1351
1352	Event Marker settings	Bit 0 = Event 16 ⇒ Bit 15 = Event 1
<b>Segment Parameters - Program 4</b>		
1400	Run Program (value = Delayed Start value)	Write only
1401	No. of Cycles Programmed	1 to 9999 plus 10000 (INF)
1402	Timebase	0 = hours/minutes, 1 = minutes/seconds
1403	Guaranteed Soak Band value	0 (OFF), 1 to span
1404 to 1419	Final Setpoint values (Dwell = -32768, End = -16384)	Segment 1 at address 1404 ↓ Segment 16 at address 1419
1420 to 1435	Rate values (Dwell = -32768, End = -16384)	Segment 1 at address 1420 ↓ Segment 16 at address 1435
1436 to 1451	Time values	Segment 1 at address 1436 ↓ Segment 16 at address 1451
1452	Event Marker settings	Bit 0 = Event 16 ⇒ Bit 15 = Event 1

Some of the parameters which do not apply to a particular instrument configuration (e.g. PB2 on a single output instrument) will accept reads & writes. Others will accept reads only, and will return an exception if an attempt is made to write values to them. The values read will in all cases be undefined. It is the user's responsibility to make sure that values read reflect a possible state of the instrument.

## 4.5 PROFILER STATUS BYTE

The Profiler Status byte has the following format:

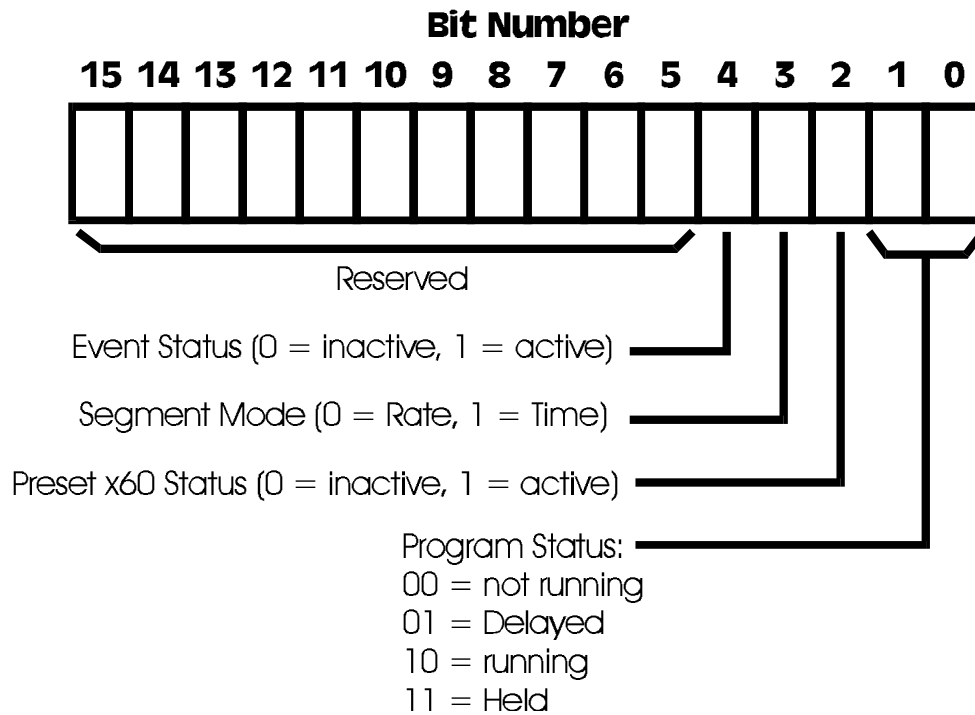

## 4.6 PROFILER COMMANDS

The Profiler Commands are as follows:

- 0001      Manually hold currently-running program
- 0002      Release Manual Hold on current program
- 0003      Abort currently-running/held program



# **$\frac{1}{16}$ -DIN PROFILER/CONTROLLER**

## **PRODUCT MANUAL**

### **VOLUME II INSTALLATION & CONFIGURATION INSTRUCTIONS**



The procedures described in this Volume must be undertaken only by technically-competent servicing personnel.

## **CONTENTS**

<b>1</b>	<b>INSTALLATION</b>	<b>1-1</b>
1.1	UNPACKING PROCEDURE	1-1
1.2	PANEL-MOUNTING THE CONTROLLER	1-1
1.3	CONNECTIONS AND WIRING	1-2
<b>2</b>	<b>INTERNAL LINKS AND SWITCHES</b>	<b>2-1</b>
2.1	REMOVING THE PROFILER/CONTROLLER FROM ITS HOUSING	2-1
2.2	REMOVING/REPLACING THE OUTPUT 2/OUTPUT 3 OPTION PCBs	2-3
2.3	REMOVING/REPLACING THE RS485 COMMUNICATIONS OPTION PCB OR REMOTE RUN/HOLD OPTION PCB	2-3
2.4	REPLACING THE INSTRUMENT IN ITS HOUSING	2-3
2.5	SELECTION OF INPUT TYPE AND OUTPUT 1 TYPE	2-4
2.6	OUTPUT 2 TYPE/OUTPUT 3 TYPE	2-6
<b>3</b>	<b>CONFIGURATION MODE</b>	<b>3-1</b>
3.1	ENTRY INTO CONFIGURATION MODE	3-1
3.2	HARDWARE DEFINITION CODE	3-1
3.3	OPTION SELECTION	3-3

3.4	CONFIGURATION MODE PARAMETERS	3-4
3.5	EXIT FROM CONFIGURATION MODE	3-9

**APPENDIX A PRODUCT SPECIFICATION**

**APPENDIX B SUMMARY OF DISPLAYS**

# 1 INSTALLATION

## 1.1 UNPACKING PROCEDURE

1. Remove the Controller from its packing. The Controller is supplied with a panel gasket and push-fit fixing strap. Retain the packing for future use, should it be necessary to transport the Controller to a different site or to return it to the supplier for repair/testing.

2. Examine the delivered items for damage or deficiencies. If any is found, notify the carrier immediately.

## 1.2 PANEL-MOUNTING THE CONTROLLER

The panel on which the Controller is to be mounted must be rigid and may be up to 6.0mm (0.25 inches) thick. The cut-out required for a single Controller is as shown in Figure 1-1.

Several controllers may be installed in a single cut-out, side-by-side. For  $n$  Controllers mounted side-by-side, the width of the cut-out would be:

$(48n - 4)$  millimetres or  $(3.78n - 0.16)$  inches.

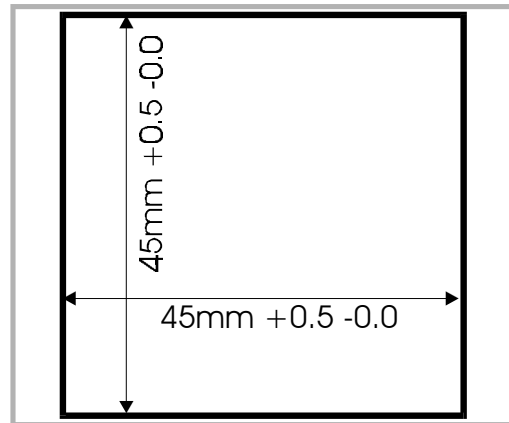

Figure 1-1 Cut-out Dimensions

The Profiler/Controller is 110mm deep (measured from the rear face of the front panel). The front panel is 48mm high and 48mm wide. When panel-mounted, the front panel projects 10mm from the mounting panel. The main dimensions of the Controller are shown in Figure 1-2.

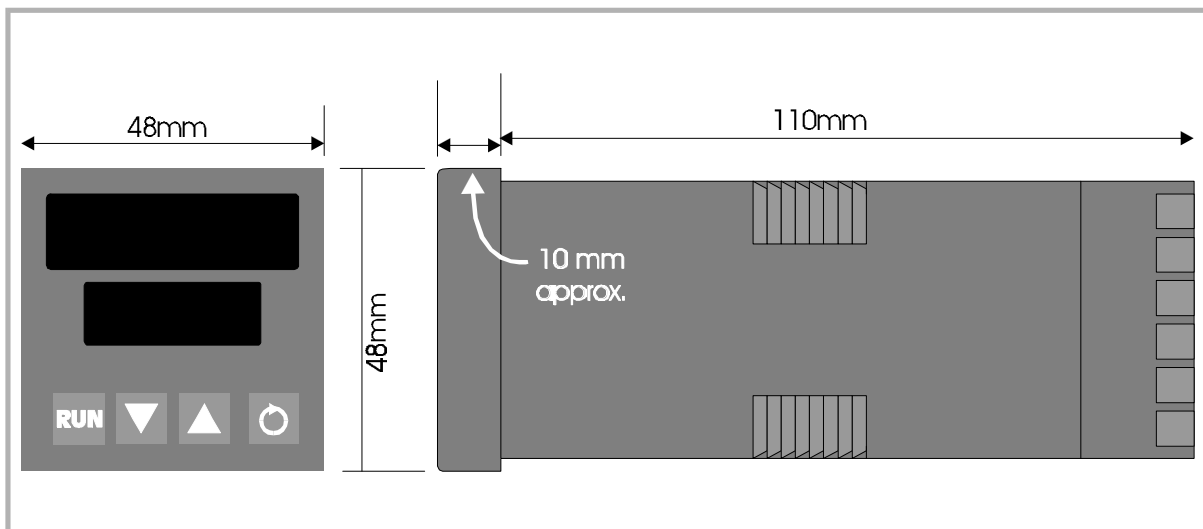

Figure 1-2 Main Dimensions

The procedure to panel-mount the Profiler/Controller is shown in Figure 1-3.



**CAUTION:** Do not remove the panel gasket, as this may result in inadequate clamping of the instrument in the panel.

**NOTE:** When installing several Controllers side-by-side in one cut-out, use the ratchets on the top/bottom faces.

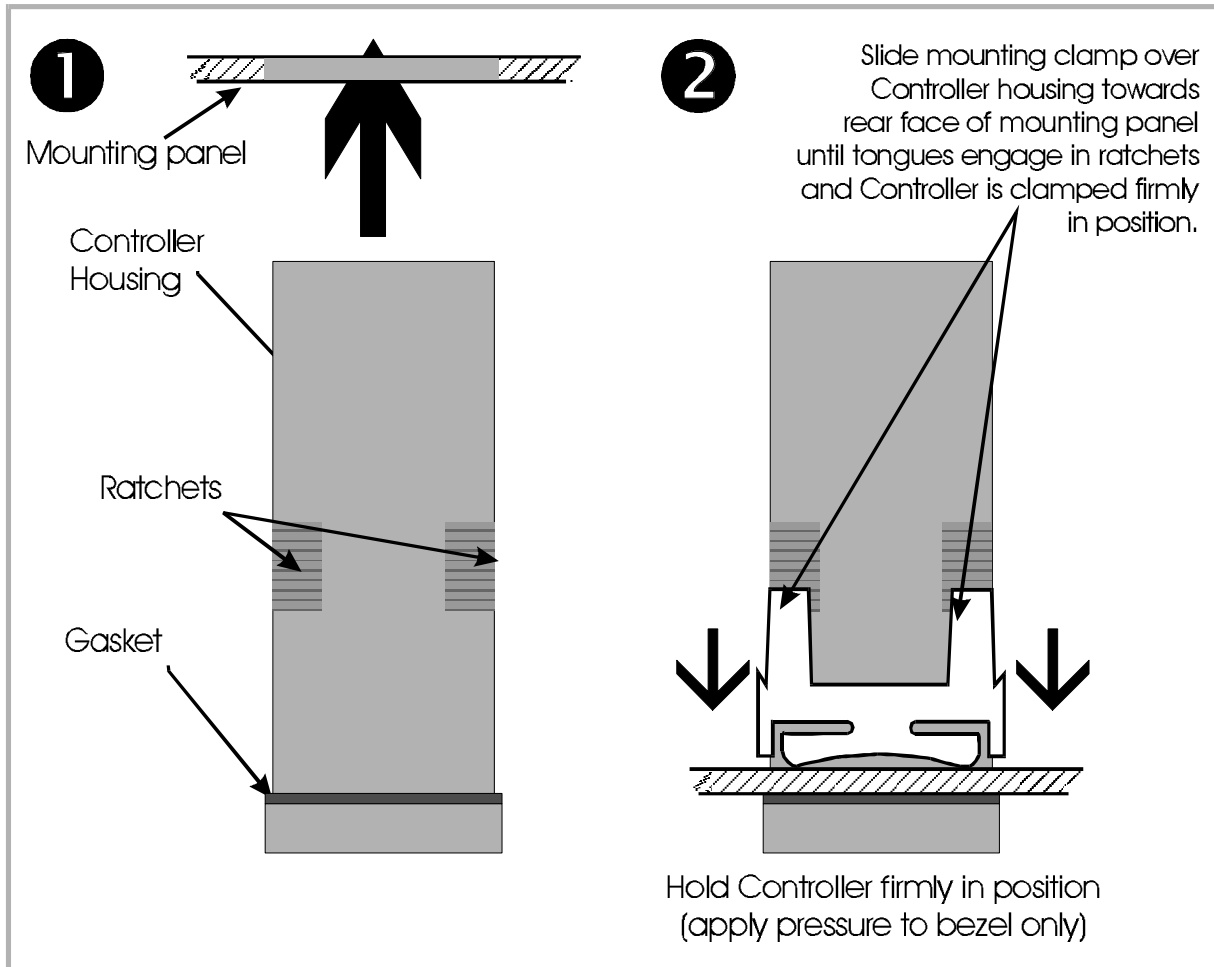

Figure 1-3 Panel-Mounting the Profiler/Controller

Once the Controller is installed in its mounting panel, it may be subsequently removed from its housing, if necessary, as described in Subsection 2.1.

### 1.3 CONNECTIONS AND WIRING

The rear terminal connections are illustrated in Figure 1-4.



This instrument is designed for installation in an enclosure which provides adequate protection against electric shock. All pertinent local regulations should be rigidly observed. Consideration should be given to prevention of access to the rear terminals by unauthorised personnel.

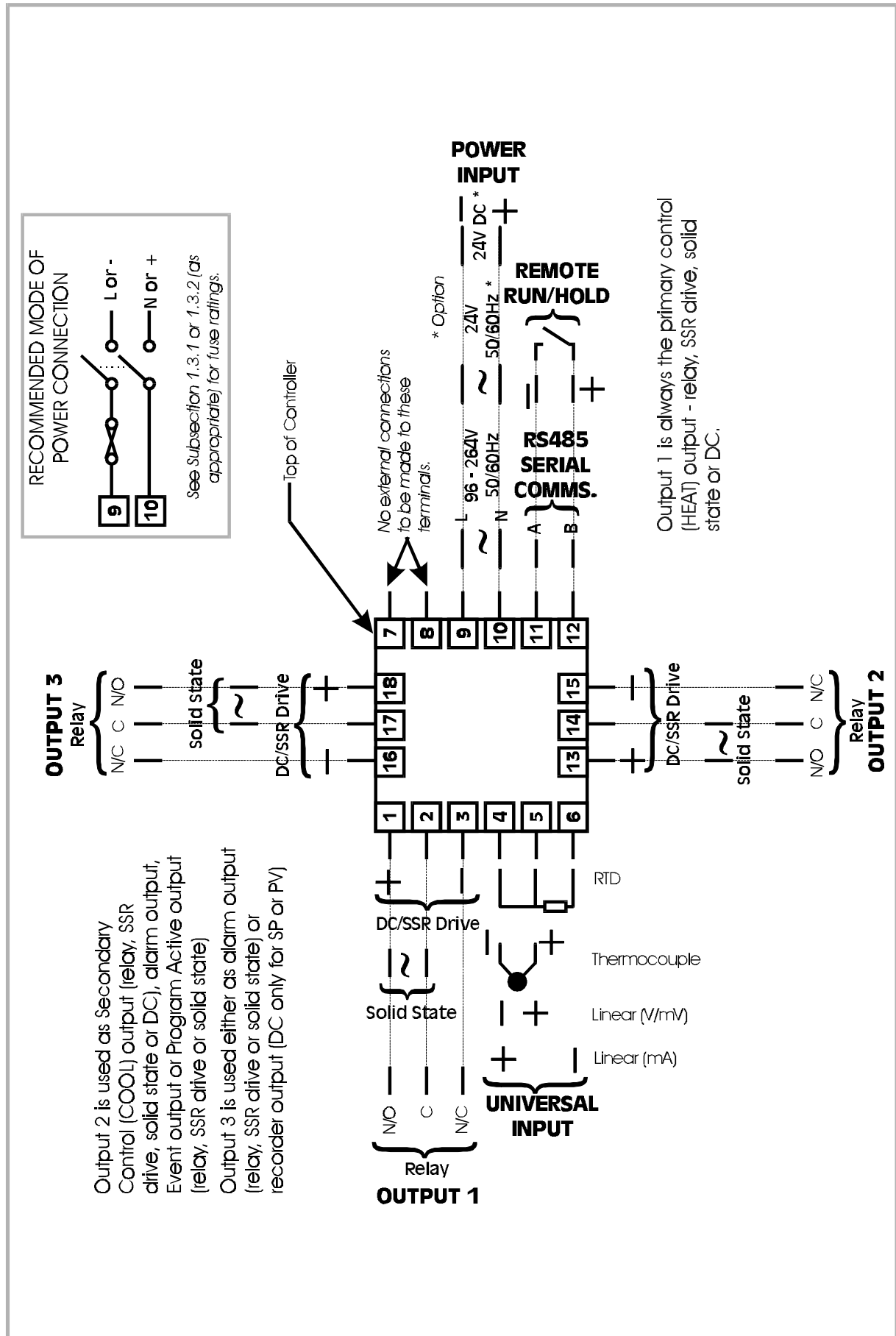

Figure 1-4 Rear Terminal Connections

### 1.3.1 Mains (Line) Input

The Controller will operate on 96 - 264V AC 50/60Hz mains (line) supply. The power consumption is approximately 4 VA. Power should be connected via a two-pole isolating switch (preferably situated near the equipment) and a 1A fuse.

If the Controller has relay outputs in which the contacts are to carry mains (line) voltage, it is recommended that the relay contact mains (line) supply should be switched and fused in a similar manner but should be separate from the Controller mains (line) supply.

### 1.3.2 24V (Nominal) AC/DC Supply

The supply connections for the 24V AC/DC option of the Controller are as shown in Figure 1-4. Power should be connected via a two-pole isolating switch and a 315mA slow-blow (anti-surge Type T) fuse.

With the 24V AC/DC supply option fitted, these terminals will accept the following supply voltage ranges:

24V (nominal) AC 50/60Hz -	20 - 50V
24V (nominal) DC -	22 - 65V

### 1.3.3 Thermocouple Input

The correct type of thermocouple extension leadwire or compensating cable must be used for the entire distance between the Controller and the thermocouple, ensuring that the correct polarity is observed throughout. Joints in the cable should be avoided, if possible. The Controller's CJC facility must be enabled (normal conditions) for this input (see Subsection 3.4).

NOTE: Do not run thermocouple cables adjacent to power-carrying conductors. If the wiring is run in a conduit, use a separate conduit for the thermocouple wiring. If the thermocouple is grounded, this must be done at one point only. If the thermocouple extension lead is shielded, the shield must be grounded at one point only.

### 1.3.4 RTD Inputs

The compensating lead should be connected to Terminal 4. For two-wire RTD inputs, Terminals 4 and 5 should be linked. The extension leads should be of copper and the resistance of the wires connecting the resistance element should not exceed 5 ohms per lead (the leads should be of equal length).

### 1.3.5 Linear Inputs

For linear mA input ranges, connection is made to Terminals 4 and 6 in the polarity shown in Figure 1-4. For linear mV and V ranges, connection is made to Terminals 4 and 5 in the polarity shown in Figure 1-4. For details of the linear input ranges available, refer to Appendix A.

### 1.3.6 Remote Run/Hold Input

With this option fitted, Terminals 11 and 12 are used for external Run/Hold control of the currently-selected program; this has an effect identical to that of the front panel **RUN** key. These terminals may be connected to (a) the voltage-free contacts of a switch or relay, or (b) a TTL-compatible voltage. This is an edge-sensitive input for which the following convention has been adopted:

For TTL input, OFF = logic 1 and ON = logic 0  
 For a voltage-free input, OFF = open and ON = closed

Program control is as follows:

OFF-ON transition:	The currently-selected program will run (or will resume running if it is currently held).
ON-OFF transition:	The currently-running program will be held.

NOTE: When this input is used, the front panel **RUN** key can be used only to abort a program. Powering-up the Profiler/Controller whilst this input is ON will not cause a program to run. The RS485 Serial Communications option and the Remote Run/Hold option are mutually exclusive.

### 1.3.7 Relay Outputs

The contacts are rated at 2A resistive at 120/240V AC.

### 1.3.8 SSR Drive Outputs

These outputs produce a time-proportioned non-isolated DC signal (0 - 4.2V nominal into 1k $\Omega$  minimum).

### 1.3.9 Solid State Outputs

These outputs provide up to 1A AC drive with a longer lifetime than an electromechanical relay. For further details, refer to Appendix A.

### **1.3.10 DC Outputs**

See Appendix A.

### **1.3.11 RS485 Serial Communications Link**

The cable used should be suitable for data transfer at the selected rate (1200, 2400, 4800 or 9600 Baud) over the required distance. Transmitters/receivers conform to the recommendations in the EIA Standard RS485.

The A terminal (Terminal 11) on the Controller should be connected to the A terminal on the master device; the B terminal (Terminal 12) on the Controller should be connected to the B terminal on the master device. Where several Controllers are connected to one master port, the master port transceiver in the active state should be capable of driving a load of 12k $\Omega$  per Controller; the master port transceiver in the passive state must have pull-up/pull-down resistors of sufficiently low impedance to ensure that it remains in the quiescent state whilst supplying up to  $\pm 100\mu\text{A}$  each to the Controller transceivers in the high impedance state.

**NOTE:** The RS485 Serial Communications option and the Remote Run/Hold option are mutually exclusive.



## 2 INTERNAL LINKS AND SWITCHES

### 2.1 REMOVING THE PROFILER/CONTROLLER FROM ITS HOUSING



**CAUTION:** Before removing the instrument from its housing, ensure that all power has been removed from the rear terminals.

To withdraw the instrument from its housing, simply grip the side edges of the front panel (there is a finger grip on each edge) and pull the instrument forwards. This will release the instrument from its rear connectors in the housing and will give access to the instrument PCBs. Take note of the orientation of the instrument for subsequent replacement into the housing. The positions of the PCBs in the instrument are shown in Figure 2-1.

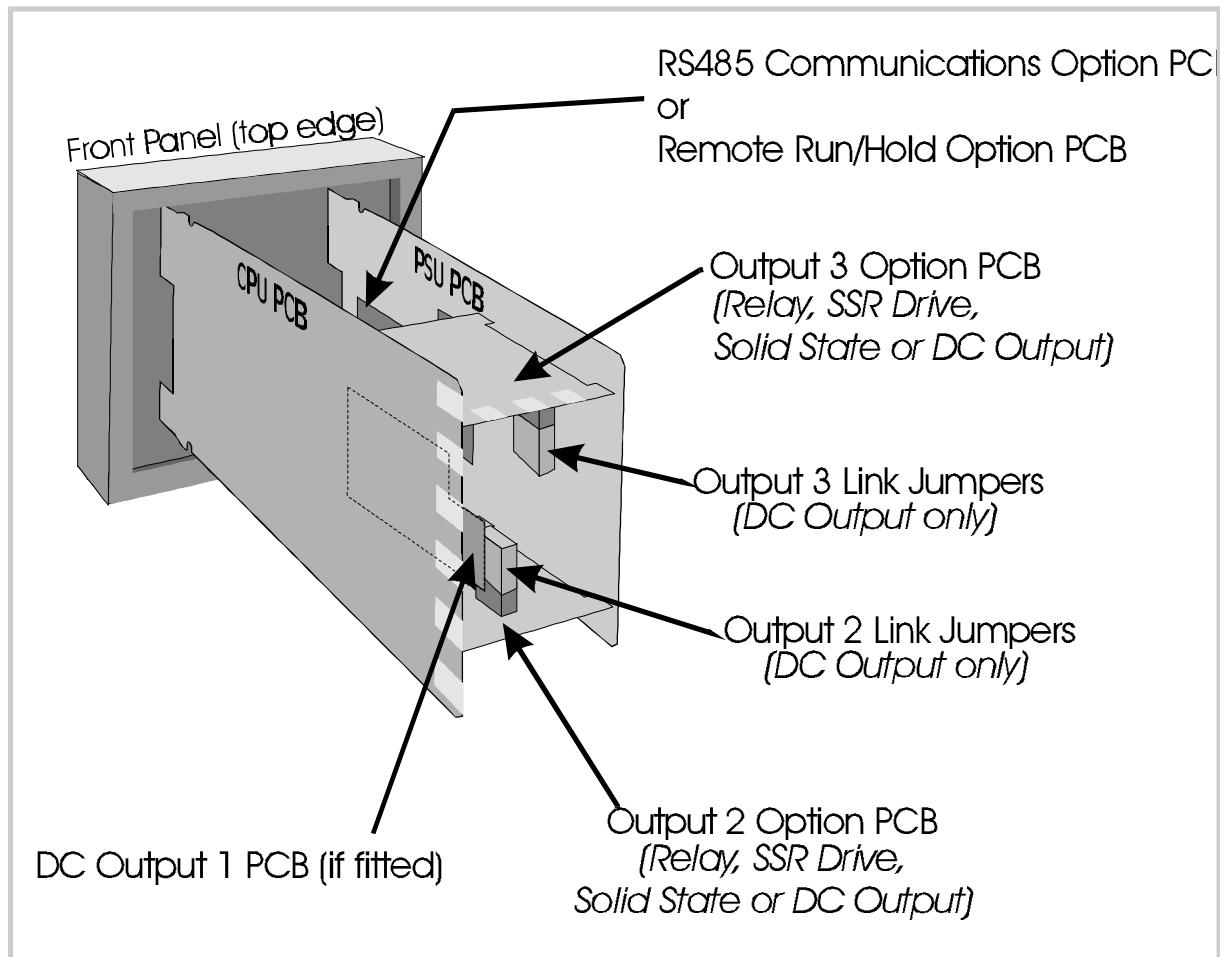

Figure 2-1 PCB Positions

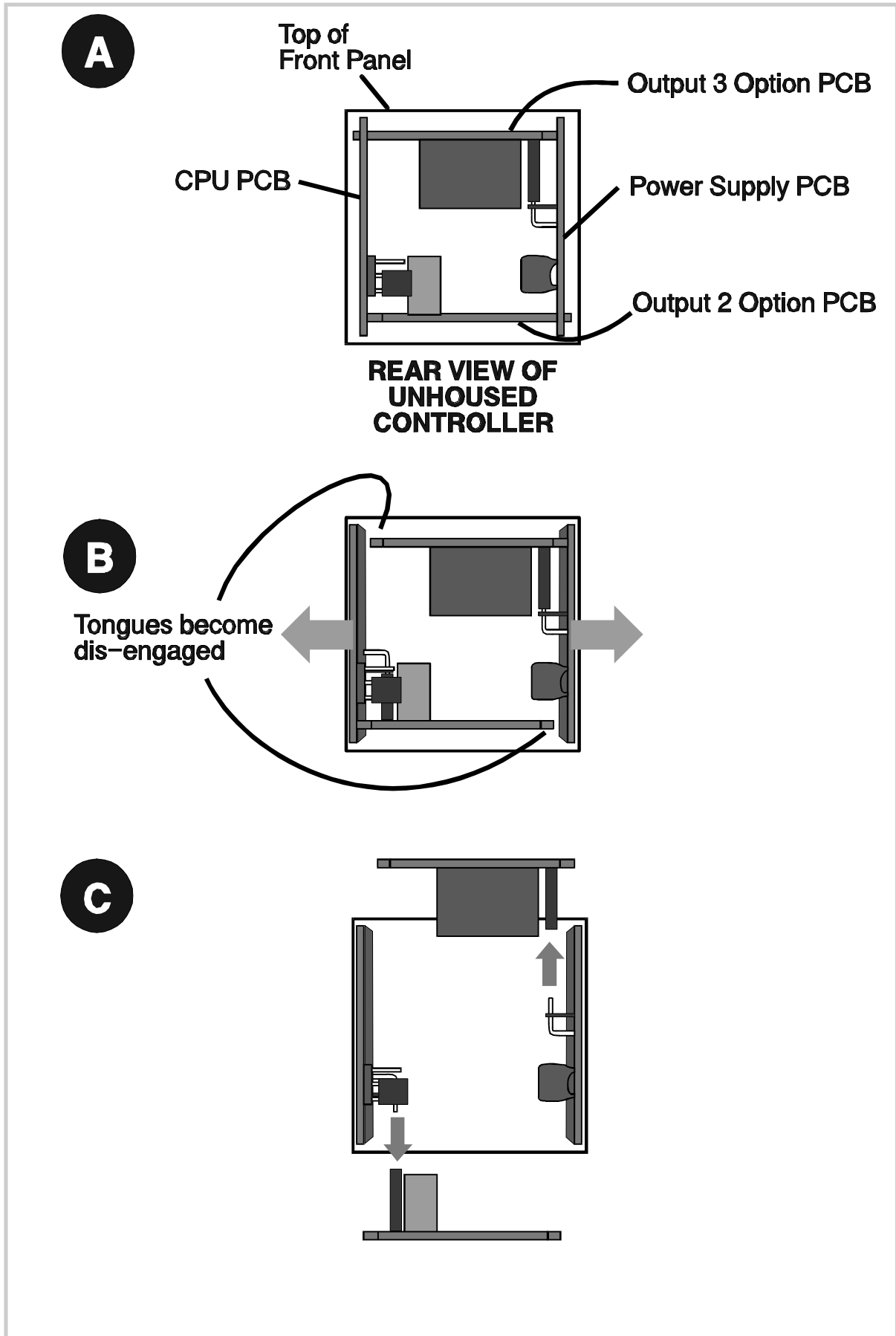

Figure 2-2 Removing the Output 2/Output 3 Option PCBs

## 2.2 REMOVING/REPLACING THE OUTPUT 2/OUTPUT 3 OPTION PCBs

With the instrument removed from its housing:

1. Gently push the rear ends of the CPU PCB and Power Supply PCB apart slightly, until the two tongues on each of the Output 2/Output 3 Option PCBs become dis-engaged - see Figure 2-2B; The Output 2 Option PCB tongues engage in holes in the Power Supply PCB and the Output 3 Option PCB tongues engage in holes on the CPU PCB.
2. Carefully pull the required Option PCB (Output 2 or Output 3) from its connector (Output 2 Option PCB is connected to the CPU PCB and Output 3 Option PCB is connected to the Power Supply PCB) - see Figure 2-2C. Note the orientation of the PCB in preparation for its replacement.

Adjustments may now be made to the link jumpers on the CPU PCB, the Output 2/Output 3 Option PCBs (if DC output) and (if fitted) the DC Output 1 PCB. The replacement procedure is a simple reversal of the removal procedure.

## 2.3 REMOVING/REPLACING THE RS485 COMMUNICATIONS OPTION PCB OR REMOTE RUN/HOLD OPTION PCB

The RS485 Communications Option PCB or Remote Run/Hold Option PCB is mounted on the inner surface of the Power Supply PCB and can be removed when the instrument is removed from its housing (see Subsection 2.1) Figure 2-3 illustrates the removal/replacement procedure. *It is not necessary to remove the Output 2/Output 3 Option PCBs to perform this procedure.*

## 2.4 REPLACING THE INSTRUMENT IN ITS HOUSING

To replace the instrument, simply align the CPU PCB and Power Supply PCB with their guides and connectors in the housing and slowly but firmly push the instrument into position.



**CAUTION:** Ensure that the instrument is correctly orientated. A stop will operate if an attempt is made to insert the instrument in the wrong orientation (e.g. upside-down). *This stop must not be over-ridden.*

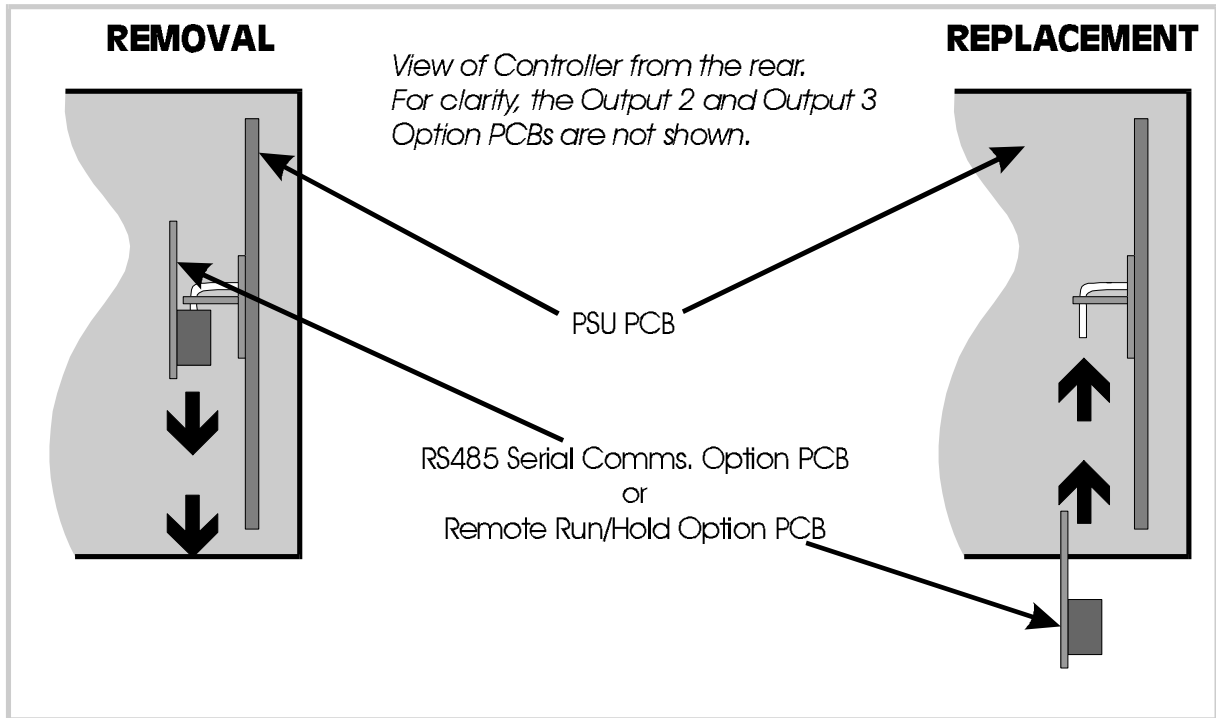

Figure 2-3 Removing the RS485 Communications Option PCB or the Remote Run/Hold Option PCB

## 2.5 SELECTION OF INPUT TYPE AND OUTPUT 1 TYPE

The selection of input type and Output 1 type is accomplished on link jumpers on the CPU PCB. The CPU PCB may be either of two forms: (a) for a relay, solid state or SSR drive Output 1 (see Figure 2-4) or for a DC Output 1 (see Figure 2-5).

### 2.5.1 Input Type

The required input type is selected on link jumpers LJ1/LJ2/LJ3 on the CPU PCB (see Figure 2-4 or 2-5, as appropriate, and Table 2-1).

Table 2-1 Selection of Input Type

Input Type	Link Jumpers Fitted
RTD or DC (mV)	None (Parked)
Thermocouple	LJ3
DC (mA)	LJ2
DC (V)	LJ1

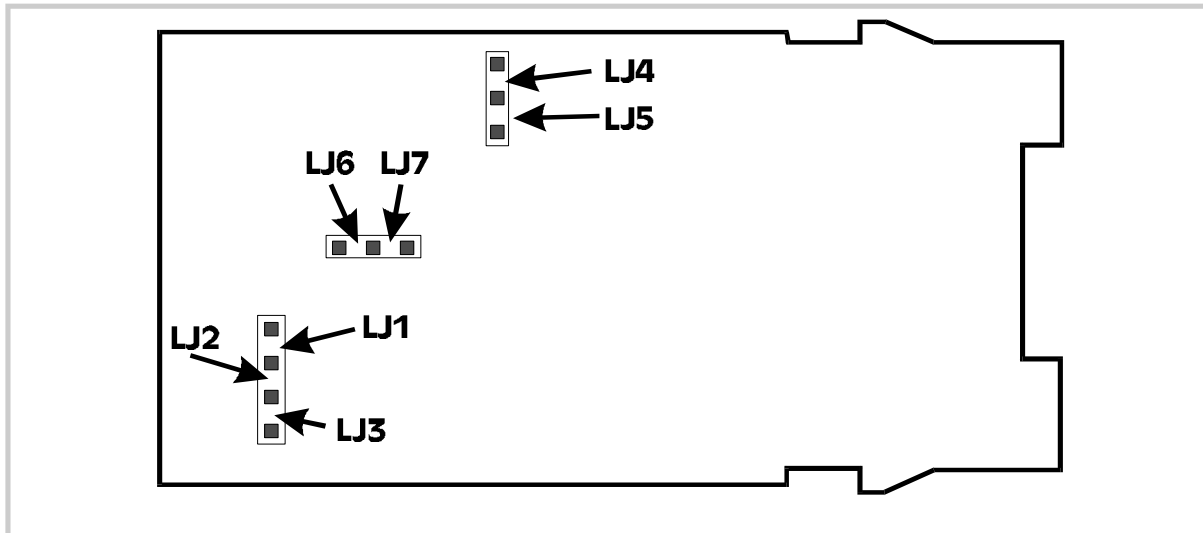

Figure 2-4 CPU PCB (Relay/SSR Drive/Solid State Output 1)

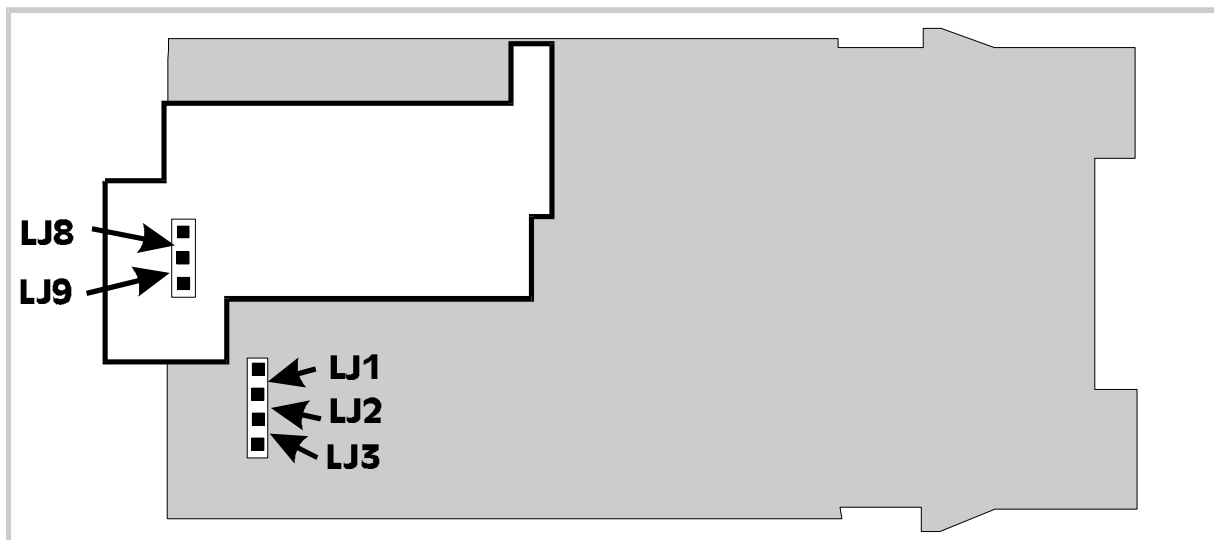

Figure 2-5 CPU PCB (DC Output 1)

### 2.5.2 Primary Output (Output 1) Type

The required type of Output 1 is selected by Link Jumpers LJ4, LJ5, LJ6 and LJ7 on the Relay/SSR Drive/Solid State Output 1 CPU PCB (see Figure 2-4 and Table 2-2) or, on the DC Output 1 CPU PCB, Link Jumpers LJ8 and LJ9 (see Figure 2-5 and Table 2-2).

Table 2-2 Selection of Output 1 Type

Output 1 Type	Link Jumpers Fitted
Relay or Solid State	LJ5 & LJ6
SSR Drive	LJ4 & LJ7
DC (0 - 10V)	LJ8
DC (0 - 20mA)	LJ9
DC (0 - 5V)	LJ8
DC (4 - 20mA)	LJ9

## 2.6 OUTPUT 2 TYPE/OUTPUT 3 TYPE

The type of output for Output 2 and Output 3 is determined by the Option PCB fitted in the appropriate position (see Figure 2-1) and, in the case of the DC Output Option PCB being fitted, the setting of Link Jumpers LJ8 and LJ9 on that Option PCB (see Figure 2-6 and Table 2-3). There are three types of option PCB which may be used for Output 2 and Output 3:

1. Relay Output Option PCB (no link jumpers)
2. Solid State Output Option PCB (no link jumpers)
3. SSR Drive Output Option PCB (no link jumpers)
3. DC Output Option PCB (link jumpers as shown in Figure 2-6)

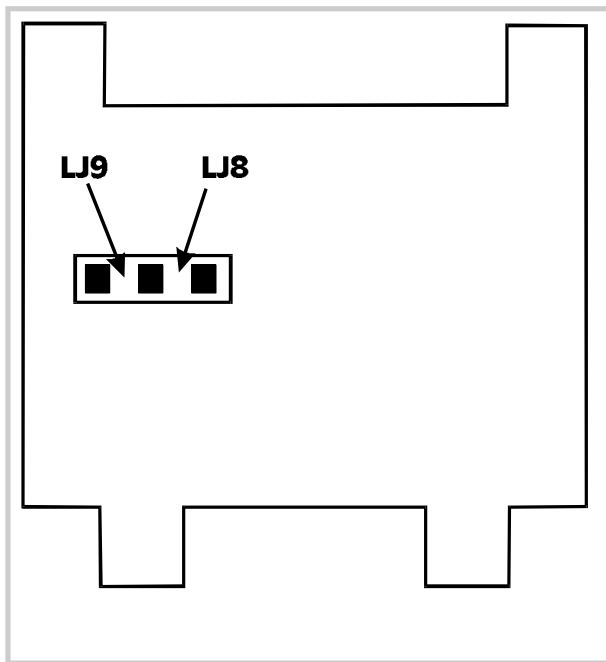

Figure 2-6 DC Output Option PCB (Output 2/Output 3)

Table 2-3 Selection of Output 2 & Output 3 Type

DC Output Range	Link Jumpers Fitted
DC (0 - 10V)	LJ8
DC (0 - 20mA)	LJ9
DC (0 - 5V)	LJ8
DC (4 - 20mA)	LJ9

# 3 CONFIGURATION MODE

## 3.1 ENTRY INTO CONFIGURATION MODE

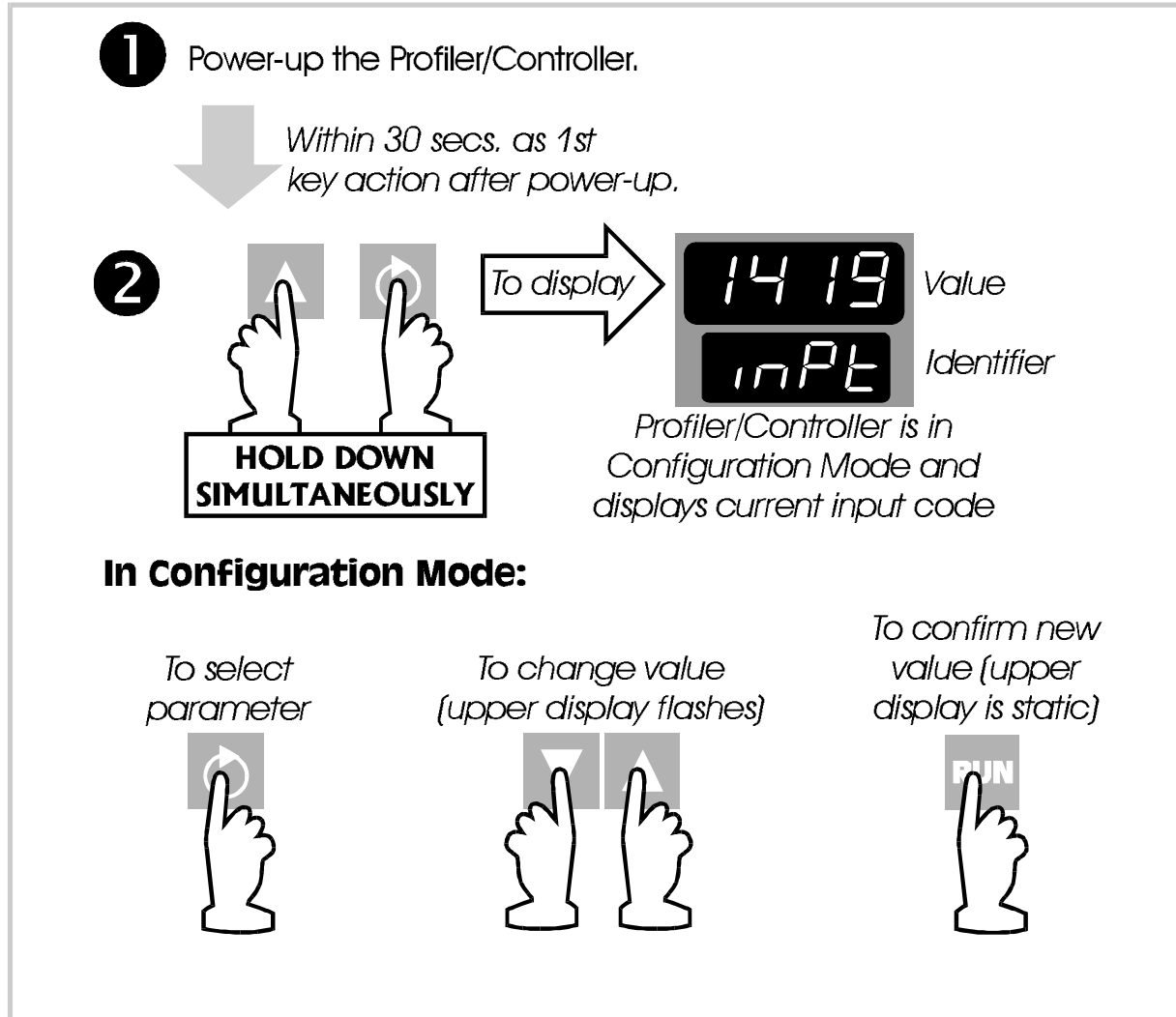

Figure 3-1 Entry into Configuration Mode

NOTE: Changes to the value/setting of certain Configuration Mode parameters (e.g. input range, output use and type) will cause the Set Up Mode parameters to be automatically set to their default values the next time Set Up Mode is entered (see also Volume I, beginning of Section 3).

## 3.2 HARDWARE DEFINITION CODE

This parameter is a special facility in Configuration Mode, which is used to represent the hardware fitted (input type, Output 1 type, Output 2 type and Output 3 type); this must be compatible with the hardware actually fitted. For access to, and adjustment of, the Hardware Definition Code, see Figure 3-2 and Table 3-1.

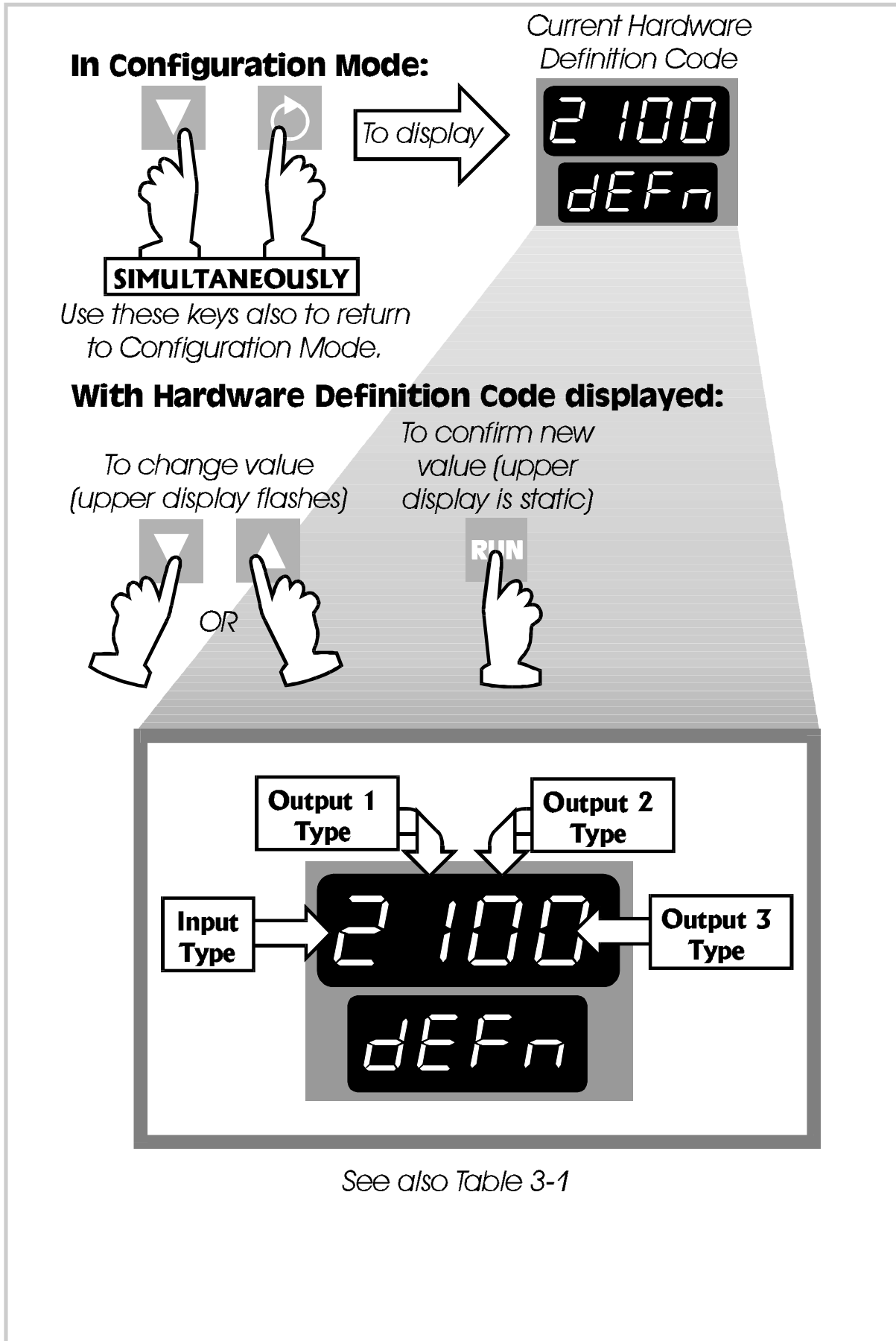

Figure 3-2 Hardware Definition Code - Access and Adjustment



Table 3-1 Hardware Definition Code - Input/Output Type Selection

Value	0	1	2	3	4	5	7	8
Input		RTD/ Linear DC mV	Thermo- couple	Linear DC mA	Linear DC V			
Output 1		Relay	SSR Drive	DC 0 - 10V	DC 0 - 20mA	DC 0 - 5V	DC 4 - 20mA	Solid State
Output 2/3	Not fitted	Relay	SSR Drive	DC 0 - 10V	DC 0 - 20mA	DC 0 - 5V	DC 4 - 20mA	Solid State*

\* Output 2 only

**NOTES:**

1. If Output 2 is a relay/SSR drive/solid state output, it may be a control output (COOL), an event output or an alarm output; if it is set to be a DC output, it can only be a control output (COOL).

2. If Output 3 is a relay/SSR drive output (it cannot be a solid state output), it can only be an event output or an alarm output; if it is set to be a DC output, it can only be a recorder (i.e. re-transmitted process variable or setpoint) output.

The maximum setting available for this code is 4887. For example, the code for a thermocouple input, DC 4 - 20mA primary output (Output 1) and relay Output 3 would be 2701.



**NOTE:** It is essential that this code is changed promptly whenever there is a change to the instrument's hardware configuration (change of input/output type, alarm/recorder output added/removed etc.). The instrument software depends upon this code to ensure that the instrument operates correctly.

This code may be viewed as a Read Only display in Base Mode (see Volume I, Subsection 1.11).

### 3.3 OPTION SELECTION

This indicates the option fitted (Communications Option, Remote Run/Hold option or no option at all). It is accessed whilst the Hardware Definition Code is displayed (see Figure 3-3).

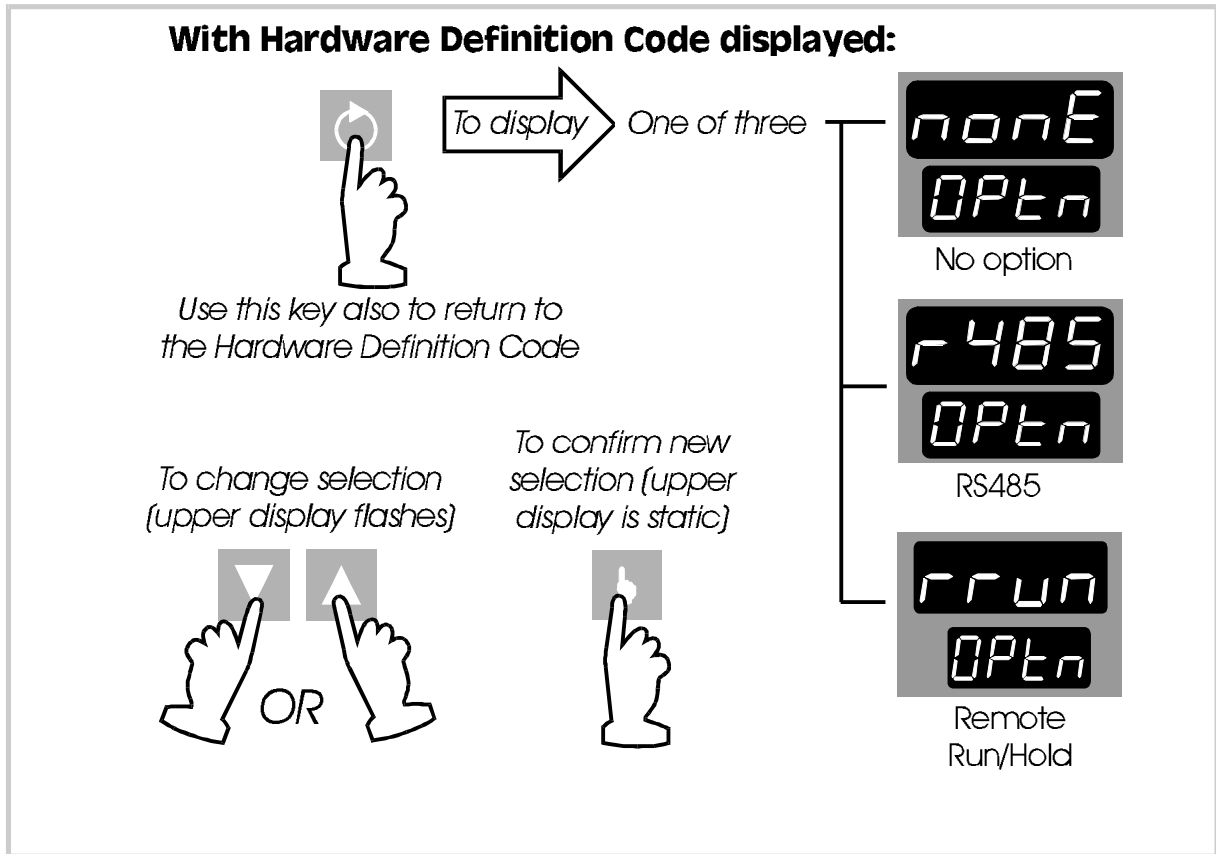

Figure 3-3 Option Selection

### 3.4 CONFIGURATION MODE PARAMETERS

Parameter	Identifier	Description
Input Range	<b>inPt</b>	A four-digit code (see Appendix A). Default settings: Thermocouple - 1419 (Type J, 0 - 761°C) RTD/Linear mV - 7220 (RTD Pt100 0 - 800°C) Linear mA - 3414 (4 - 20mA) Linear V - 4446 (0 - 10V)
Output 1 Action	<b>Ctrl</b>	<b>rEv</b> Reverse-acting <b>dir</b> Direct-acting
Alarm 1 Type	<b>ALAI</b>	<b>P_h</b> Process High Alarm <b>P_Lo</b> Process Low Alarm <b>dE</b> Deviation Alarm <b>bAnd</b> Band Alarm <b>nonE</b> No alarm

Parameter	Identifier	Description
Alarm 2 Type	<b>ALa2</b>	<b>P_h1</b> Process High Alarm
		<b>P_Lo</b> Process Low Alarm (default)
		<b>dE</b> Deviation Alarm
		<b>bAnd</b> Band Alarm
		<b>nonE</b> No alarm
Alarm Inhibit	<b>Inhi</b>	<b>nonE</b> No alarms inhibited
		<b>ALa1</b> Alarm 1 inhibited
		<b>ALa2</b> Alarm 2 inhibited
		<b>both</b> Both Alarm 1 & Alarm 2 inhibited
Program Mode	<b>TYPE</b>	<b>rA</b> Rate
		<b>t1</b> Time

Parameter	Identifier	Description
Output 2 Usage	<b>USE2</b>	<b>OUT2</b> Output 2 secondary control (COOL) output
		<b>A2_d</b> Alarm 2 hardware output, direct-acting. Available only if relay/SSR drive/solid state output.
		<b>A2_r</b> Alarm 2 hardware output, reverse-acting. Available only if relay, SSR drive or solid state output.
		<b>Or_d</b> Direct-acting output for Logical OR of Alarm 1 and Alarm 2. Available only if relay, SSR drive, or solid state output.
		<b>Or_r</b> Reverse-acting output for Logical OR of Alarm 1 and Alarm 2. Available only if relay, SSR drive, or solid state output.
		<b>Ad_d</b> Direct-acting output for Logical AND of Alarm 1 and Alarm 2. Available only if relay, SSR drive, or solid state output.
		<b>Ad_r</b> Reverse-acting output for Logical AND of Alarm 1 and Alarm 2. Available only if relay, SSR drive, or solid state output.
		<b>Pr_d</b> Profile Active output, direct-acting. Available only if relay, SSR drive or solid state output.
		<b>Pr_r</b> Profile Active output, reverse-acting. Available only if relay, SSR drive or solid state output.
		<b>Et</b> Event output, direct-acting. Available only if relay, SSR drive or solid state output.

Example of Logical Combination of Alarms - Logical OR of Alarm 1 & Alarm 2

Direct-acting	Reverse-acting
AL1 OFF, AL2 OFF: Relay de-energised	AL1 OFF, AL2 OFF: Relay energised
AL1 ON, AL2 OFF: Relay energised	AL1 ON, AL2 OFF: Relay de-energised
AL1 OFF, AL2 ON: Relay energised	AL1 OFF, AL2 ON: Relay de-energised
AL1 ON, AL2 ON: Relay energised	AL1 ON, AL2 ON: Relay de-energised

Parameter	Identifier	Description
Output 3 Usage	<b>USE3</b>	<b>Al_d</b> Alarm 1 hardware output, direct-acting. Available only if relay/SSR drive/solid state output.
		<b>Al_r</b> Alarm 1 hardware output, reverse-acting. Available only if relay, SSR drive or solid state output.
		<b>Or_d</b> Direct-acting output for Logical OR of Alarm 1 and Alarm 2. Available only if relay, SSR drive, or solid state output.
		<b>Or_r</b> Reverse-acting output for Logical OR of Alarm 1 and Alarm 2. Available only if relay, SSR drive, or solid state output.
		<b>Ad_d</b> Direct-acting output for Logical AND of Alarm 1 and Alarm 2. Available only if relay, SSR drive, or solid state output.
		<b>Ad_r</b> Reverse-acting output for Logical AND of Alarm 1 and Alarm 2. Available only if relay, SSR drive, or solid state output.
		<b>rEcS</b> Recorder Output - Setpoint (DC output only)
		<b>rEcP</b> Recorder Output - Process Variable (DC Output only)
		<b>Pr_d</b> Profile Active output, direct-acting. Available only if relay or SSR drive output.
		<b>Pr_r</b> Profile Active output, reverse-acting. Available only if relay or SSR drive output.
		<b>Et</b> Event output, direct-acting. Available only if relay or SSR drive output.

Example of Logical Combination of Alarms - Logical AND of Alarm 1 & Alarm 2

Direct-acting	Reverse-acting
AL1 OFF, AL2 OFF: Relay de-energised	AL1 OFF, AL2 OFF: Relay energised
AL1 ON, AL2 OFF: Relay de-energised	AL1 ON, AL2 OFF: Relay energised
AL1 OFF, AL2 ON: Relay de-energised	AL1 OFF, AL2 ON: Relay energised
AL1 ON, AL2 ON: Relay energised	AL1 ON, AL2 ON: Relay de-energised

Parameter	Identifier	Description
Δ & ∇ LEDs Usage (on Front Panel)	<b>LEdS</b>	<p><b>r d i r</b> Ramp direction:  Δ = positive ramp  ∇ = negative ramp  both = dwell</p> <p><b>o u t S</b> Output state:  Δ = Output 1 ON  ∇ = Output 2 ON</p>
Guaranteed Soak Enable/Disable (see Volume I, Subsection 2.2.5)	<b>S o A P</b>	<p><b>E n A b</b> Enabled</p> <p><b>d i S A</b> Disabled</p> <p><b>M A n</b> Manual</p>
Delayed Start Enable/Disable	<b>d E L Y</b>	<p><b>E n A b</b> Enabled</p> <p><b>d i S A</b> Disabled</p>
Power Loss Recovery	<b>r E c</b>	<p><b>c o l d</b> Cold Start (program re-started from beginning)</p> <p><b>h o t</b> Warm Start (program resumed from point at which power failed)</p>
Start On	<b>S t O n</b>	<p><b>P r o c</b> Start program with setpoint at current process variable value</p> <p><b>S E T P</b> Start program with setpoint at Controller Setpoint value</p>
Communications Protocol	<b>P r o t</b>	<p><b>P 7 b o</b> MODBUS with odd parity</p> <p><b>P 7 b E</b> MODBUS with even parity</p> <p><b>P 7 b n</b> MODBUS with no parity</p>
Communications Baud Rate	<b>b A u d</b>	Selectable: 1200, 2400, 4800, 9600 Baud
Communications Address	<b>A d d r</b>	Unique address assigned to the controller; in the range 1 - 255.
Cold Junction Compensation Enable/Disable*	<b>C J C</b>	<p><b>E n A b</b> Enabled (default)</p> <p><b>d i S A</b> Disabled</p>

\* Appears only if a thermocouple input is selected (see Hardware definition Code).

Parameter	Identifier	Description
Controller Set-Up Mode Lock Code	<b>LOC L</b>	Read Only display of current four-digit Set Up Mode Lock Code.
Program Define Mode Lock Code	<b>LOC P</b>	Read Only display of current four-digit Program Define Mode Lock Code.

### 3.5 EXIT FROM CONFIGURATION MODE

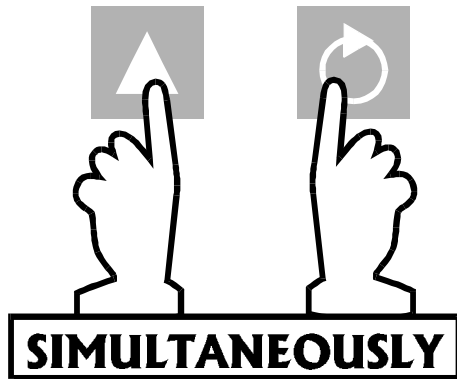

NOTE: An automatic exit to Operator Mode will be made if, in Configuration Mode, there is no front panel key activity for two minutes.

The exit is made via the power-up self-test routines which include a lamp test.

# APPENDIX A PRODUCT SPECIFICATION

## UNIVERSAL INPUT

### General

- Maximum per Controller: One
- Input Sample Rate: Four samples/second
- Digital Input Filter: Time constant selectable from front panel - 0.0 (i.e. OFF), 0.5 to 100.0 seconds in 0.5-second increments.
- Input Resolution: 14 bits approximately; always four times better than display resolution.
- Input Impedance: Greater than 100MΩ resistive (except for DC mA and V inputs).
- Isolation: Universal input isolated from all outputs except SSR at 240V AC.
- Process Variable Offset: Adjustable ±input span.

**Thermocouple:** Ranges selectable from front panel:

Type	Input Range	Displayed Code	Type	Input Range	Displayed Code
R	0 - 1650°C	1127	J	32 - 1401°F	1420
R	32 - 3002°F	1128	T	-200 - 262°C	1525
S	0 - 1649°C	1227	T	-328 - 503°F	1526
S	32 - 3000°F	1228	T	0.0 - 260.6°C	1541
J	0.0 - 205.4°C	1415	T	32.0 - 501.0°F	1542
J	32.0 - 401.7°F	1416	K	-200 - 760°C	6726
J	0 - 450°C	1417	K	-328 - 1399°F	6727
J	32 - 842°F	1418	K	-200 - 1373°C	6709 *
J	0 - 761°C	1419 *	K	-328 - 2503°F	6710

\* Default

Continued overleaf.....



Type	Input Range	Displayed Code	Type	Input Range	Displayed Code
L	0.0 - 205.7°C	1815	B	211 - 3315°F	1934
L	32.0 - 402.2°F	1816	B	100 - 1824°C	1938
L	0 - 450°C	1817	N	0 - 1399°C	5371
L	32 - 841°F	1818	N	32 - 2550°F	5324
L	0 - 762°C	1819	C/W5	0 - 2316°C	5111
L	32 - 1403°F	1820	C/W5	32 - 4201°F	5112

Calibration: Complies with BS4937, NBS125 and IEC584.

Sensor Break Protection: Break detected within two seconds. Control outputs set to OFF (0% power); Alarms operate as if the process variable has gone over-range.

### Resistance Temperature Detector (RTD) and DC mV: Ranges selectable from front panel:

Input Range	Displayed Code	Input Range	Displayed Code
0 - 800°C *	7220	0.0 - 100.9°C	2295
32 - 1471°F	7221	32.0 - 213.6°F	2296
32 - 571°F	2229	-200 - 206°C	2297
-100.9 - 100.0°C	2230	-328 - 402°F	2298
-149.7 - 211.9°F	2231	-100.9 - 537.3°C	7222
0 - 300°C	2251	-149.7 - 999.1°F	7223

\* Default

Type and Connection: Three-wire Pt100

Calibration: Complies with BS1904 and DIN43760.

Lead Compensation: Automatic scheme.

RTD Sensor Current: 150 $\mu$ A (approximately)

Sensor Break Protection: Break detected within two seconds. Control outputs set to OFF (0% power). For RTD input, alarms operate as if the process variable has gone under-range. For DC (mV) input, alarms operate as if the process variable has gone over-range.

**DC Linear: Ranges Selectable from Front Panel:**

Input Range	Displayed Code	Input Range	Displayed Code
0 - 20mA	3413	0 - 5V	4445
4 - 20mA *	3414	1 - 5V	4434
0 - 50mV	4443	0 - 10V *	4446
10 - 50mV	4499	2 - 10V	4450

\* Default

(Changes may also be required to the CPU PCB link jumpers - see Subsection 2.5.1.)

Scale Range Maximum:	1999 to 9999. Decimal point as required.
Scale Range Minimum:	1999 to 9999. Decimal point as for Scale Range Maximum.
Minimum Span:	1 display LSD.
Sensor Break Protection:	Applicable to 4 - 20mA, 1 - 5V and 2 - 10V ranges only. Break detected within two seconds. Control outputs set to OFF (0% power); Alarms operate as if the process variable has gone under-range.

**REMOTE RUN/HOLD INPUT (OPTION)**

Type:	Voltage-free or TTL-compatible; edge-sensitive. OFF-ON transition - currently-selected program will run or (if currently held) resume running. ON-OFF transition - currently-running program will be held.
Voltage-Free Operation:	Connection to contacts of external switch or relay; contacts open = OFF (minimum contact resistance = 5000 $\Omega$ ), contacts closed = ON (maximum contact resistance = 50 $\Omega$ ).
TTL levels:	OFF: 0.6V to 0.8V ON: 2.0V to 24V
Maximum Input Delay (OFF-ON):	1 second

Minimum Input Delay  
(ON-OFF): 1 second

## OUTPUT 1

### General

Types Available: Relay (as standard), SSR drive, solid state and DC as options.

### Relay

Contact Type: Single pole double throw (SPDT).

Rating: 2A resistive at 120/240V AC.

Lifetime: >500,000 operations at rated voltage/current.

Isolation: Inherent.

### SSR Drive/TTL

Drive Capability: SSR >4.2V DC into 1k $\Omega$  minimum.

Isolation: Not isolated from input or other SSR outputs.

### Solid State

Operating Voltage Range: 20 - 280Vrms (47 - 63Hz)

Current Rating: 0.01 - 1A (full cycle rms on-state @ 25°C); derates linearly above 40°C to 0.5A @ 80°C.

Max. Non-repetitive Surge Current (16.6ms): 25A peak

Min. OFF-State  $\frac{dv}{dt}$  @ Rated Voltage: 500V/ $\mu$ s

Max. OFF-State leakage @ Rated Voltage: 1mA rms

Max. ON-State Voltage Drop @ Rated Current: 1.5V peak.

Repetitive Peak OFF-state Voltage, Vdrm: 600V minimum

**DC**

Resolution:	Eight bits in 250mS (10 bits in 1 second typical, >10 bits in >1 second typical).
Update Rate:	Every control algorithm execution.
Ranges:	0 - 20mA 4 - 20mA 0 - 10V 0 - 5V

(Changes between V and mA ranges also require link jumper movement.)

Load Impedance:	0 - 20mA: 500 $\Omega$ maximum 4 - 20mA: 500 $\Omega$ maximum 0 - 10V: 500 $\Omega$ minimum 0 - 5V: 500 $\Omega$ minimum
Isolation:	Isolated from all other inputs and outputs.
Range Selection Method:	Link jumper or DIP switch and front panel code.

**OUTPUT 2****General**

Types Available:	Relay, SSR drive, solid state and DC.
------------------	---------------------------------------

**Relay**

Contact Type:	Single pole double throw (SPDT).
Rating:	2A resistive at 120/240V AC.
Lifetime:	>500,000 operations at rated voltage/current.
Isolation:	Inherent.

**SSR Drive/TTL**

Drive Capability:	SSR >4.2V DC into 1k $\Omega$ minimum.
Isolation:	Not isolated from input or other SSR outputs.

**Solid State**

Operating Voltage Range:	20 - 280Vrms (47 - 63Hz)
Current Rating:	0.01 - 1A (full cycle rms on-state @ 25°C); derates linearly above 40°C to 0.5A @ 80°C.
Max. Non-repetitive Surge Current (16.6ms):	25A peak
Min. OFF-State $\frac{dv}{dt}$ @ Rated Voltage:	500V/ $\mu$ s
Max. OFF-State leakage @ Rated Voltage:	1 mA rms
Max. ON-State Voltage Drop @ Rated Current:	1.5V peak.
Repetitive Peak OFF-state Voltage, Vdrm:	600V minimum

**DC**

Resolution:	Eight bits in 250mS (10 bits in 1 second typical, >10 bits in >1 second typical).
Update Rate:	Every control algorithm execution.
Ranges:	0 - 20mA 4 - 20mA 0 - 10V 0 - 5V

(Changes between V and mA ranges also require link jumper movement.)

Load Impedance:	0 - 20mA: 500 $\Omega$ maximum 4 - 20mA: 500 $\Omega$ maximum 0 - 10V: 500 $\Omega$ minimum 0 - 5V: 500 $\Omega$ minimum
Isolation:	Isolated from all other inputs and outputs.
Range Selection Method:	Link jumper or DIP switch and front panel code.

## OUTPUT 3

### General

Types Available: Relay, SSR drive, DC linear (Recorder Output only)

### Relay

Contact Type: Single pole double throw (SPDT).

Rating: 2A resistive at 120/240V AC.

Lifetime: >500,000 operations at rated voltage/current.

Isolation: Inherent.

### SSR Drive/TTL

Drive Capability: SSR >4.2V DC into 1k $\Omega$  minimum.

Isolation: Not isolated from input or other SSR outputs.

### DC

Resolution: Eight bits in 250mS (10 bits in 1 second typical, >10 bits in >1 second typical).

Update Rate: Every control algorithm execution.

Ranges: 0 - 20mA  
4 - 20mA  
0 - 10V  
0 - 5V

(Changes between V and mA require link jumper movement.)

Load Impedance: 0 - 20mA: 500 $\Omega$  maximum  
4 - 20mA: 500 $\Omega$  maximum  
0 - 10V: 500 $\Omega$  minimum  
0 - 5V: 500 $\Omega$  minimum

Isolation: Isolated from all other inputs and outputs.

Range Selection Method: Link jumper or DIP.

## LOOP CONTROL

Automatic Tuning Types:	Pre-Tune
Proportional Bands:	0 (OFF), 0.5% - 999.9% of input span at 0.1% increments.
Reset (Integral Time Constant):	1s - 99min 59s and OFF
Rate (Derivative Time Constant):	0 (OFF) - 99 min 59 s.
Manual Reset (Bias):	Added each control algorithm execution. Adjustable in the range 0 - 100% of output power (single output) or 100% to +100% of output power (dual output).
Deadband/Overlap:	20% to +20% of Proportional Band 1 + Proportional Band 2.
ON/OFF Differential:	0.1% to 10.0% of input span.
Auto/Manual Control:	User-selectable with bumpless transfer into and out of Manual Control.
Cycle Times:	Selectable from $\frac{1}{2}$ s to 512 secs in binary steps.
Setpoint Range:	Limited by Range Maximum and Range Minimum.

## ALARM CONTROL

Maximum Number of Alarms:	Two soft alarms.
Max. No. of Outputs Available:	Up to two outputs can be utilised for alarm purposes.
Combinatorial Alarms:	Logical OR or AND of alarms to an individual hardware output is available.

## PERFORMANCE

### Reference Conditions

Generally as EN60546-1.

Ambient Temperature:	20°C ±2°C
Relative Humidity:	60 - 70%
Supply Voltage:	90 - 264V AC 50Hz (1%
Source Resistance:	<10Ω for thermocouple input
Lead Resistance:	<0.1Ω/lead balanced (Pt100)

### Performance Under Reference Conditions

Common Mode Rejection:	>120dB at 50/60Hz giving negligible effect at up to 264V 50/60Hz.
Series Mode Rejection:	>500% of span (at 50/60Hz) causes negligible effect.

### DC Linear Inputs

Measurement Accuracy:	±0.25% of span ±1LSD.
-----------------------	-----------------------

### Thermocouple Inputs

Measurement Accuracy:	±0.25% of span ±1LSD. NOTE: Reduced performance with Type B Thermocouple between 100 - 600°C (212 - 1112°F).
Linearisation Accuracy:	Better than ±0.2°C any point, any 0.1°C range (±0.05°C typical). Better than ±0.5°C any point, any 1°C range.
Cold Junction Compensation:	Better than ±0.7°C.

### RTD Inputs

Measurement Accuracy:	±0.25% of span ±1LSD
Linearisation Accuracy:	Better than ±0.2°C any point, any 0.1°C range (±0.05°C typical). Better than ±0.5°C any point, any 1°C range.



## DC Outputs - Accuracy

Output 1:	$\pm 0.5\%$ (mA @ 250 $\Omega$ , V @ 2k $\Omega$ ); 2% underdrive (4 - 20mA) and overdrive applies.
Output 2:	$\pm 0.5\%$ (mA @ 250 $\Omega$ , V @ 2k $\Omega$ ); 2% underdrive (4 - 20mA) and overdrive applies.
Output 3 (Recorder Output):	$\pm 0.25\%$ (mA @ 250 $\Omega$ , V @ 2k $\Omega$ ); Degrades linearly to $\pm 0.5\%$ for increasing burden (to specification limits).

## Operating Conditions

Ambient Temperature (Operating):	0°C to 55°C
Ambient Temperature (Storage):	20°C to 80°C
Relative Humidity:	20% - 95% non-condensing
Supply Voltage:	90 - 264V AC 50/60Hz (standard) 20 - 50V AC 50/60Hz or 22 - 65V DC (option)
Source Resistance:	1000 $\Omega$ maximum (thermocouple)
Lead Resistance:	50 $\Omega$ per lead maximum balanced (Pt100)

## Performance Under Operating Conditions

Temperature Stability:	0.01% of span/ $^{\circ}$ C change in ambient temperature.
Cold Junction Compensation (thermocouple Only):	Better than $\pm 1^{\circ}$ C.
Supply Voltage Influence:	Negligible.
Relative Humidity Influence:	Negligible
Sensor Resistance Influence:	Thermocouple 100 $\Omega$ : <0.1% of span error Thermocouple 1000 $\Omega$ : <0.5% of span error RTD Pt100 50 $\Omega$ /lead: <0.5% of span error

## ENVIRONMENTAL

Operating Conditions:	See <b>PERFORMANCE</b> .
Approvals:	CE, UL, cUL
EMI Susceptibility:	Certified to EN50082-1:1992 and EN50082-2:1995. NOTE: For line-conducted disturbances induced by RF fields (10V 80% AM 1kHz), the product is self-recoverable in the frequency bands 17 - 47MHz and 68 - 80MHz.
EMI Emissions:	Certified to EN50081-1:1992 and EN50081-2:1994.
Safety Considerations:	Complies with EN61010-1:1993.
Supply Voltage:	90 - 264V AC 50/60Hz (standard) 20 - 50V AC 50/60Hz or 22 - 65V DC (option)
Power Consumption:	4 watts approximately.
Front Panel Sealing:	To IP66 (NEMA 4).

## PHYSICAL

Dimensions:	Depth - 110mm
Front Panel:	Width - 48mm, Height - 48mm (1/16 DIN)
Mounting:	Plug-in with panel mounting fixing strap. Panel cut-out 45mm x 45mm.
Terminals:	Screw type (combination head).
Weight:	0.21kg maximum

## APPENDIX B SUMMARY OF DISPLAYS

The lower display on the Profiler/Controller front panel is used to identify the parameter being displayed. The parameter identifiers are as follows:

Legend	Meaning	Ref.	
		Volume	Section
<b>Base Mode Parameters</b>			
<b>P888</b>	Manual Power (xxx = power output value)	1	1.12
<b>SP</b>	Setpoint	1	1.1
<b>dELY</b>	Delayed Start	1	1.2
<b>F588</b>	Final (Target) Setpoint for Segment xx (01 - 16)	1	1.6
<b>t_r</b>	Time remaining	1	1.6
<b>CY_r</b>	Cycles remaining	1	1.6
<b>Auto</b>	Automatic/Manual Control selection	1	1.6
<b>EvSt</b>	Event/Alarm Status	1	1.6
<b>Prog</b>	Current Program (1 - 4)	1	1.6
<b>Controller Set-Up Mode Parameters</b>			
<b>FILT</b>	Input Filter Time Constant	1	3.1
<b>OFFS</b>	Process Variable Offset	1	3.1
<b>Out1</b>	Output 1 Power (0 - 100%)	1	3.1
<b>Out2</b>	Output 2 Power (0 - 100%)	1	3.1
<b>Pb1</b>	Proportional Band 1	1	3.1
<b>Pb2</b>	Proportional Band 2	1	3.1
<b>rSET</b>	Reset (Integral Time Constant)	1	3.1
<b>rRtE</b>	Rate (Derivative Time Constant)	1	3.1
<b>OL</b>	Deadband/Overlap	1	3.1
<b>biAS</b>	Bias (Manual Reset)	1	3.1
<b>dIFF</b>	ON/OFF Differential (both outputs)	1	3.1
<b>dIF1</b>	ON/OFF Differential (Output 1 only)	1	3.1
<b>dIF2</b>	ON/OFF Differential (Output 2 only)	1	3.1
<b>SPL</b>	Setpoint Lock	1	3.1
<b>roPH</b>	Recorder Output Scale Maximum	1	3.1
<b>roPL</b>	Recorder Output Scale Minimum	1	3.1

Legend	Meaning	Ref.	
<b>Controller Set-Up Mode Parameters (Continued)</b>		<b>Volume</b>	<b>Section</b>
<b>OPh<sub>1</sub></b>	Output Power Maximum	1	3.1
<b>Ct<sub>1</sub></b>	Output 1 Cycle Time	1	3.1
<b>Ct<sub>2</sub></b>	Output 2 Cycle Time	1	3.1
<b>h<sub>A1</sub></b>	Process High Alarm 1 value	1	3.1
<b>L<sub>A1</sub></b>	Process Low Alarm 1 value	1	3.1
<b>d<sub>A1</sub></b>	Deviation Alarm 1 value	1	3.1
<b>b<sub>A1</sub></b>	Band Alarm 1 value	1	3.1
<b>AHY<sub>1</sub></b>	Alarm 1 Hysteresis value	1	3.1
<b>h<sub>A2</sub></b>	Process High Alarm 2 value	1	3.1
<b>L<sub>A2</sub></b>	Process Low Alarm 2 value	1	3.1
<b>d<sub>A2</sub></b>	Deviation Alarm 2 value	1	3.1
<b>b<sub>A2</sub></b>	Band Alarm 2 value	1	3.1
<b>AHY<sub>2</sub></b>	Alarm 2 Hysteresis value	1	3.1
<b>rPnt</b>	Decimal Point Position (for linear input range)	1	3.1
<b>rhi</b>	Range Maximum (for linear input range)	1	3.1
<b>rLo</b>	Range Minimum (for linear input range)	1	3.1
<b>POEn</b>	Manual Power Selection enable/disable	1	3.1
<b>SPSt</b>	Setpoint Strategy	1	3.1
<b>CoEn</b>	Communications Write enable/disable	1	3.1
<b>Loc</b>	Lock Code	1	3.1
<b>Program Define Mode Parameters</b>			
<b>88_r</b>	Ramp Rate for segment xx (xx in range 01 - 16)	1	2.2.2
<b>88_d</b>	Segment xx is currently set as a Dwell segment	1	2.2.2-3
<b>88_E</b>	Segment xx is currently set as an End segment	1	2.2.2-3
<b>88_F</b>	Final (Target) Setpoint value for Segment xx	1	2.2.2-3
<b>88_t</b>	Segment Time for Segment xx	1	2.2.2-3
<b>cycl</b>	Number of Cycles Programmed	1	2.2.4
<b>base</b>	Timebase (hours/minutes or minutes/seconds)	1	2.2.4
<b>05b</b>	Guaranteed Soak Band value	1	2.2.4
<b>E-88</b>	Event Marker setting for Segment xx	1	2.2.4

Legend	Meaning	Ref.	
		Volume	Section
<b>Configuration Mode Parameters</b>			
<b>dEFn</b>	Hardware Definition Code	2	3.2
<b>oPtN</b>	Hardware Option selection	2	3.3
<b>inPt</b>	Input Type selection	2	3.4
<b>Ctrl</b>	Control Action	2	3.4
<b>ALA1</b>	Alarm 1 Type	2	3.4
<b>ALA2</b>	Alarm 2 Type	2	3.4
<b>Inhi</b>	Alarm Inhibit	2	3.4
<b>TYPE</b>	Program Mode (Rate or Time)	2	3.4
<b>USE2</b>	Output 2 Usage	2	3.4
<b>USE3</b>	Output 3 Usage	2	3.4
<b>LEd5</b>	LED Usage ( $\Delta$ and $\nabla$ )	2	3.4
<b>SoAP</b>	Guaranteed Soak Action	2	3.4
<b>dELy</b>	Delayed Start enable/disable	2	3.4
<b>rEc</b>	Power Fail Recovery (Warm Start/Cold Start)	2	3.4
<b>Prot</b>	MODBUS parity selection	2	3.4
<b>bAud</b>	Communications Baud rate	2	3.4
<b>Addr</b>	Communications Address (Zone)	2	3.4
<b>CJC</b>	Cold Junction Compensation enable/disable	2	3.4
<b>LocL</b>	Controller Set-Up Mode Lock Code	2	3.4
<b>LocP</b>	Program Define Mode Lock Code	2	3.4
<b>Miscellaneous</b>			
<b>SEt</b>	Entry to Controller Set-Up Mode or Program Define Mode	1	2.1 & 3.1
<b>U loc</b>	User to enter lock code to access either Controller Set-Up Mode or Program Define Mode	1	2.1 & 3.1

# ALPHABETICAL INDEX

Page references are shown in the form x/y-z, where x is the Volume Number (I or II), y is the Section Number within that Volume and z is the Page Number within that Section. Thus, the reference to the second page of the third Section in Volume II would be II/3-2.

## A

Aborting a Program	I/1-2
Active Program Setpoint	
Display of	I/1-3
Alarm 1 Hysteresis	I/3-5
Alarm 1 Status	
Display of	I/1-1, I/1-3
Alarm 1 Type	II/3-4
Alarm 2 Hysteresis	I/3-5
Alarm 2 Status	
Display of	I/1-1, I/1-3
Alarm 2 Type	II/3-5
Alarm Hysteresis	
Description of	I/3-8
Alarm Inhibit	II/3-5
Alarm Operation	
Description of	I/3-7
Automatic Control	
Selection of	I/1-7

## B

Band Alarm 1	I/3-4
Band Alarm 2	I/3-5
Baud Rates Available	I/4-1
Bias	I/3-3
Bit Parameters	I/4-7
Broadcast Messages	I/4-2

## C

Cold Junction Compensation	
Enabling/disabling	II/3-8
Communications	
Enabling/disabling	I/3-5
Communications Address	
Selection of	II/3-8
Communications Baud Rate	
Selection of	II/3-8
Communications Protocol	
Selection of	II/3-8
Control Mode	
Display of	I/1-1, I/1-3
Configuration Mode	
Entry into	II/3-1
Exit from	II/3-9
Controller Dimensions	II/A-11
Controller Set-Up Mode	
Entry into	I/3-1
Exit from	I/3-9
Controller Set-Up Mode Lock Code	
Display of	II/3-8
Cycles Remaining	
Display of	I/1-3
Cyclic Redundancy Checksum	
Description of	I/4-5

**D**

Data Format	I/4-2
Deadband	I/3-3
Description of	I/3-6
Delayed Start	
Enabling/disabling	II/3-8
Delay Time	
Selection of	I/1-2
Derivative Time Constant	I/3-3
Deviation Alarm 1	I/3-4
Deviation Alarm 2	I/3-5

**E**

Error Responses	I/4-5
Event Markers	
Defining	I/2-5
Event Output Status	
Display of	I/1-1, I/1-3
Exception Codes	I/4-5
Exception Responses	I/4-5

**F**

Final Setpoint	
Display of	I/1-3
Fuse Rating	
24V AC/DC supply	II/1-4
Mains supply	II/1-4

**G**

Guaranteed Soak	
Enabling/Disabling/Manual	II/3-8
Guaranteed Soak Band	
Defining	I/2-5
Description of	I/2-6

**H**

Hardware Definition Code	
Adjustment of	II/3-1
Display of	I/1-6, II/3-1
Explanation of	I/1-6
Input/Output Type selection	II/3-3
Holding a Program	I/1-2

**I**

Input Connections	
Linear input	II/1-5
Remote Run/Hold input	II/1-5
RTD	II/1-4
Thermocouple	II/1-4
Input Filter Time Constant	I/3-3
Input Range	II/3-4
Input Type	
Selection of	II/2-4
Integral Time Constant	I/3-3

**L**

LEDs Usage	II/3-8
Lock Code (Controller Set-Up Mode)	I/3-5
Lock Code (Program Define Mode)	
Defining	I/2-5
Logical Combination of Alarms	
Example (AND)	II/3-7
Example (OR)	II/3-6

**M**

Making a Dwell Segment	
Rate Mode	I/2-3
Time Mode	I/2-4
Making a Ramp Segment	
Rate Mode	I/2-3
Time Mode	I/2-4
Making an End Segment	
Rate Mode	I/2-3
Time Mode	I/2-4
Manual Control	
Selection of	I/1-7
Manual Control Selection	
Enabling/disabling	I/3-5
Manual Guaranteed Soak	
Description of	I/2-6
Manual Reset	I/3-3
Message formats	I/4-2
Message termination	I/4-2

**N**

Number of Cycles	
Defining	I/2-5

**O**

ON/OFF Differential	I/3-4
Description of	I/3-6
Option Selection	II/3-3
Output 1 Action	II/3-4
Output 1 Cycle Time	I/3-4
Output 1 Power Limit	I/3-4
Output 1 Type	
Selection of	II/2-5
Output 2 Cycle Time	I/3-4
Output 2 Type	
Selection of	II/2-6
Output 2 Usage	II/3-6

Output 2/Output 3 Option PCB	
Removal/replacement	II/2-3
Output 3 Type	
Selection of	II/2-6
Output 3 Usage	II/3-7
Output Connections	
DC	II/1-6
Relay	II/1-5
Solid State output	II/1-5
SSR Drive	II/1-5
Output Power 1	I/3-3
Output Power 2	I/3-3
Overlap	I/3-3
Description of	I/3-6

**P**

Panel-mounting	
Procedure	II/1-2
Panel-Mounting	
Cut-out dimensions (multiple installation)	II/1-1
Cut-out dimensions (single installation)	II/1-1
Maximum panel thickness	II/1-1
Profiler/Controller dimensions	II/1-1
Panel-mounting the Profiler/Controller	II/1-1
PCB Positions	II/2-1
Power Loss Recovery	
Cold start/Hot start	II/3-8
Pre-Tune	
Dis-engaging	I/1-4
Engaging	I/1-4
Pre-Tune Facility	
Activation of	I/1-4
Pre-Tune Status	
Indication of	I/1-5



Process High Alarm 1	I/3-4
Process High Alarm 2	I/3-5
Process Low Alarm 1	I/3-4
Process Low Alarm 2	I/3-5
Process Variable	
Adjustment of	I/1-1
Process Variable Offset	I/3-3
Profiler Commands	I/4-11
Profiler Status Byte	I/4-11
Program Definition Mode	
Entry into	I/2-1
Exit from	I/2-9
Program Mode	
Selection of	II/3-5
Program Number	
Display of	I/1-1, I/1-3
Selection of	I/1-1, I/1-2
Proportional Band	
Description of	I/3-6
Proportional Band 1	I/3-3
Proportional Band 2	I/3-3
<b>R</b>	
RaPID Control	
Dis-engaging	I/1-4
Engaging	I/1-3
RaPID Control Status	
Indication of	I/1-5
Rate	I/3-3
Rear Terminal Connections	II/1-2
Recorder Output	
Scale Maximum	I/3-4
Recorder Output	
Scale Minimum	I/3-4
Releasing a Currently-Held Program	
I/1-2	
Remote Run/Hold Option PCB	
Removal/replacement	II/2-3
Removing the Profiler/Controller from its Housing	II/2-1

Replacing the Instrument in its Housing	II/2-3
Reset	I/3-3
RS485 Communications Option PCB	
Removal/replacement	II/2-3

**S**

Scale Range Decimal	
Point Position	I/3-5
Scale Range Maximum	I/3-5
Scale Range Minimum	I/3-5
Segment Event Status	
Description of	I/2-7
Sensor Break	
Effect on outputs	
(DC linear inputs)	II/A-3
Effect on outputs	
(RTD inputs)	II/A-2
Effect on outputs	
(thermocouple inputs)	II/A-2
Serial Communications	
Connections	II/1-6
Setpoint Adjustment (in Base Mode)	
Enabling/disabling	I/3-4
Setpoint High Limit	I/3-4
Setpoint Lock	I/3-4
Setpoint Low Limit	I/3-4
Setpoint Strategy	I/3-5
Supply Connections	
24V AC/DC Option	II/1-4
Mains (Line) voltage	II/1-4

**T**

Time Remaining	
Display of	I/1-3
Timebase	
Selection of	I/2-5

**U**

Unpacking Procedure II/1-1

**W**

Word Parameters I/4-8