

HC900 Process Control Designer Software User Guide

Doc. No.: 51-52-25-110

Revision: 15

Date: September 2013

Notices and Trademarks

Copyright 2013 by Honeywell
Revision 15 September 2013

WARRANTY/REMEDY

Honeywell warrants goods of its manufacture as being free of defective materials and faulty workmanship. Contact your local sales office for warranty information. If warranted goods are returned to Honeywell during the period of coverage, Honeywell will repair or replace without charge those items it finds defective. The foregoing is Buyer's sole remedy and is **in lieu of all other warranties, expressed or implied, including those of merchantability and fitness for a particular purpose**. Specifications may change without notice. The information we supply is believed to be accurate and reliable as of this printing. However, we assume no responsibility for its use.

While we provide application assistance personally, through our literature and the Honeywell web site, it is up to the customer to determine the suitability of the product in the application.

Honeywell Process Solutions

Honeywell
1250 W Sam Houston Pkwy S
Houston, TX 77042

HC900 Process Control is a U.S. trademark of Honeywell
Other brand or product names are trademarks of their respective owners.

License Agreement

Read this agreement before opening the software. Once you have removed the software from its envelope, you have accepted the agreement.

USAGE RIGHTS

Your rights, with respect to the Software, are non-exclusive. The software may only be used by one user, on one computer at a time. The software may be transferred to another computer, as long as it is only used by one user at a time. The Software and its documentation may not be copied or distributed to others. You may not create, modify, alter, adapt, merge, de-compile or reverse-engineer the Software, and you may not remove or obscure Honeywell or other included copyright or trademark notices.

TERM OF LICENSE

This agreement is effective until terminated. Terminate the Agreement by destroying the Software, documentation and all backup copies.

BACKUP COPIES

You may make backup copies of the Software. The copyright notice(s) must be included on each backup copy.

COPYRIGHTS

The Software accompanying this manual is protected by United States copyright law. The Software documentation is copyrighted. You may only copy the Software and the Software documentation for backup or to load the Software onto your computer as part of program execution.

TITLE TO SOFTWARE AND CONFIDENTIALITY

The Software and all copies thereof are proprietary to Honeywell and title thereto remains in Honeywell. All applicable rights to patents, copyrights, trademarks and trade secrets in the Software are and shall remain in Honeywell.

You may not sell, transfer, publish, or otherwise make available any software copies thereof to others. You acknowledge that the Software is a trade secret of Honeywell. You agree to secure and protect each program, software product and copies thereof in a manner consistent with the maintenance of Honeywell's rights therein and to take appropriate action by instruction or agreement within your organization to satisfy your obligations hereunder. Violation of these provisions shall be a basis for immediate termination of this license. Termination of the license shall be in addition to and not in lieu of any other legal or equitable remedies available in Honeywell.

About This Document

Abstract

The **Designer** program operates on a PC with Windows™ 2000, XP, Vista or Windows™ 7. It lets you create, edit, view and monitor HC900 Process Control control strategy configurations as well as your Operator Interface menu, screen and button configurations. It uses graphic symbols and line drawing connections to represent control strategies. Completed configurations are loaded into the control system using a dedicated communication port in the controller.

References

The following list identifies all documents that may be sources of reference for material discussed in this publication.

Document Title	Doc ID
HC900 Controller Technical Overview	51-52-03-31
Legacy HC900 Controller Installation and User Guide	51-52-25-107
HC900 Operator Interface User Guide	51-52-25-108
HC900 Process Control Function Block Reference Guide	51-52-25-109
HC900 Process Control Communications User Guide	51-52-25-111
HC900 Process & Safety Controller User & Installation Manual	51-52-25-154
HC900 Process Controller Safety Manual	51-52-25-153

Support & Contact Information

For Europe, Asia Pacific, North and South America contact details, refer to the back page of this manual or the appropriate Honeywell Solution Support web site:

Honeywell Organization	WWW Address (URL)
Corporate	http://www.honeywell.com
Honeywell Process Solutions	http://www.hpsweb.honeywell.com/ps
HPS Technical tips	http://hpsweb.honeywell.com/Cultures/en-US/Products/Instrumentation/hybrid/hc900/TechnicalTips/documents.htm

Telephone and Email Contacts

Area	Organization	Phone Number
United States and Canada	Honeywell Inc.	1-800-343-0228 Customer Service 1-800-423-9883 Global Technical Support
Global Email Support	Honeywell Process Solutions	Email: (Sales) FP-Sales-Apps@Honeywell.com or (TAC) hfs-tac-support@honeywell.com

Symbol Definitions

The following table lists those symbols that may be used in this document to denote certain conditions.











Symbol	Definition
	This DANGER symbol indicates an imminently hazardous situation, which, if not avoided, will result in death or serious injury .
	This WARNING symbol indicates a potentially hazardous situation, which, if not avoided, could result in death or serious injury .
	This CAUTION symbol may be present on Control Product instrumentation and literature. If present on a product, the user must consult the appropriate part of the accompanying product literature for more information.
	This CAUTION symbol indicates a potentially hazardous situation, which, if not avoided, may result in property damage .
	WARNING PERSONAL INJURY: Risk of electrical shock. This symbol warns the user of a potential shock hazard where HAZARDOUS LIVE voltages greater than 30 Vrms, 42.4 Vpeak, or 60 Vdc may be accessible. Failure to comply with these instructions could result in death or serious injury.
	ATTENTION, Electrostatic Discharge (ESD) hazards. Observe precautions for handling electrostatic sensitive devices
	Protective Earth (PE) terminal. Provided for connection of the protective earth (green or green/yellow) supply system conductor.
	Functional earth terminal. Used for non-safety purposes such as noise immunity improvement. NOTE: This connection shall be bonded to protective earth at the source of supply in accordance with national local electrical code requirements.
	Earth Ground. Functional earth connection. NOTE: This connection shall be bonded to Protective earth at the source of supply in accordance with national and local electrical code requirements.
	Chassis Ground. Identifies a connection to the chassis or frame of the equipment shall be bonded to Protective Earth at the source of supply in accordance with national and local electrical code requirements.

Table of Contents

LICENSE AGREEMENT	III
ABOUT THIS DOCUMENT	IV
Abstract.....	iv
References.....	iv
Contacts.....	j
Symbol Definitions	vã
TABLE OF CONTENTS	VII
SOFTWARE INTRODUCTION AND OVERVIEW	1
Introduction	1
Features.....	1
HARDWARE AND SOFTWARE REQUIREMENTS	4
What to Know Before You Start	4
Rack, Module, and Channel Assignments	4
IMPLEMENTATION	7
Starting the Application	7
Connecting the PC to the Controller	8
USER INTERFACE	9
User Interface Overview	9
General Terminology	10
File Browser Window	11
Worksheet Toolbox Window	12
Traceback Window	15
Watch Summary Window.....	16
Status Bar	17
Menu Conventions	17
Selecting a Menu	18
Closing a Menu	18
Main Menu	18
File Menu	19
Edit Menu.....	21
View Menu	23
Monitor Menu	24
Recipes Menu	25
Window Menu	25
Help Menu.....	26
Main Toolbar Functions	27
Navigational Tools	29
Right Mouse Click.....	29
Keyboard Navigation.....	31

FILE MANAGEMENT	33
Opening an Existing File	33
Creating a New Configuration File	33
Saving A Configuration File	33
Creating Other File Types	35
Converting HC900 Configurations	36
Uploading a File from the Controller	36
Downloading a File to the Controller	37
Downloading Controller Firmware	40
Download Firmware Error Messages	42
File Properties	43
How to Add Worksheet Protection	44
File Read Protection	47
Write Protect a File	48
PC COMM PORTS AND CONNECTIONS	51
How to Manage PC Comm Ports and Connections	51
PC Network Port Set Up For Controller Access	51
PC Serial Com Port Setup	53
PC to Controller Connection Settings	55
Remote Loopback Test	56
Remote Access	57
Select the Number to Call	57
Communications Statistics	58
WORKSHEETS OVERVIEW	59
What is a Worksheet?	59
Worksheet Category Tabs	59
CONTROLLER WORKSHEET	60
Controller Worksheet Overview	60
Controller Configuration Toolbar	61
E-Mail Notification	62
Unlock the Worksheets	63
DISPLAY WORKSHEET	64
Operator Panel Worksheet Overview	64
Operator Panel Configuration Toolbar	64
Operator Interface Displays	65
Display Buttons Configuration	65
Configuring or Viewing Display Tag Groups	67
Alarm Details	71
Event List Configuration	72
Event Details	73
E-Mail Notification	73
Operator Interface Settings	74
O/I File Names for Disk Storage	76
Start Up Display Configuration	76
Message Display Configuration	77
Unlock the Worksheets	77

DATA STORAGE.....	79
Data Storage Overview.....	79
Data Storage Conventions.....	79
Data Storage Enable Conditions.....	81
Data Storage Configuration Access.....	85
Create/Edit Data Storage File.....	85
Trend Storage Configuration.....	86
Point Log Storage Configuration.....	87
Alarm/Event Storage Configuration.....	88
FUNCTION BLOCK DIAGRAM (FBD) WORKSHEET.....	91
FB Worksheet Overview.....	91
FBD Configuration Toolbar.....	92
How to Add a New FBD Worksheet.....	93
How to Navigate Between FBD Worksheets.....	93
Keyboard Navigation.....	95
Traceback Window.....	96
Resolve Dangling Soft Wires.....	97
How to Find an Item on the FBD Worksheet.....	99
How to Change a FBD's Worksheet Properties.....	100
How to Change the Worksheet Order.....	100
How to Delete a FBD Worksheet.....	100
How to Add Worksheet Protection.....	101
Alarm Group Configuration.....	103
Alarm Details.....	104
Event List Configuration.....	105
Execution Order.....	105
Event Details.....	111
E-Mail Notification.....	111
Unlock the Worksheets.....	112
FUNCTION BLOCKS OVERVIEW.....	113
Function Block Definition.....	113
Function Block Identification.....	113
Function Block Inputs and Outputs.....	113
Types of Function Blocks.....	115
Function Block Attributes.....	116
Fast Scan Indicator.....	116
USING FUNCTION BLOCKS TO BUILD A CONTROL /SAFETY STRATEGY	117
Before You Start.....	117
General Steps to Build a Control /Safety Strategy.....	117
Adding, Moving, Deleting Function Blocks to a FBD.....	118
Connecting/Disconnecting Blocks.....	120
Adding a Variable.....	122
Adding a Numeric Constant.....	123
Adding a Connector.....	124
Variables.....	125
Wire Nodes.....	125
Signal Tags.....	127

Page Connectors	129
Text String.....	131
Changing the Default Annotation Attributes	132
CONVENTIONS.....	133
Drag and Drop	133
Accessing Context Sensitive Help	133
Right Mouse Click.....	133
HOW TO CONFIGURE FUNCTION BLOCK PARAMETERS.....	134
Accessing Block Details.....	134
Function Block Address	134
User Assigned Tag Names	134
Function Block Parameters.....	134
FUNCTION BLOCK DIAGRAMS.....	135
Overview	135
Function Block Diagram Rules.....	135
Saving A Configuration File	135
UTILITIES WORKSHEET	137
Overview	137
Controller Utility Functions	137
Uploading a File from the Controller	138
Download a File to the Controller.....	138
Set Controller Serial Ports	138
Modbus RTU Master - Advanced Setup	140
Calibrate Controller	142
Set Controller Mode	142
Set Controller Network Parameters	142
Set Controller Time	145
Data Storage Utility	148
Back Up Controller Information.....	149
Restore Controller Information.....	150
Manually Write Database to Flash	152
Diagnostics	153
Calibrate Modules	153
PPO Block Calibration	156
SET POINT PROGRAMMING	161
Terms and Definitions	161
What is a Setpoint Program?	162
Setpoint Program Configuration Overview.....	163
SETPOINT SCHEDULERS.....	165
Setpoint Scheduler Overview.....	165
Setpoint Schedule Overview	165

SEQUENCERS	167
What is Sequence Control?	167
Sequence Configuration Overview	167
RECIPES	168
Recipe Overview	168
Recipes Menu	169
RECIPE (VARIABLES).....	170
Introduction	170
Recipe (Variables) Configuration	170
Using Recipes to Download Setpoint Profiles.....	171
Create/Edit Recipe (Variables) File.....	172
Recipe Pool.....	173
Setup/Edit a Recipe in Pool	174
Recipe Properties	174
SETPOINT PROFILES	175
Create/Edit Setpoint Profile File.....	175
Setpoint Profile Properties	177
SETPOINT SCHEDULES	179
Create/Edit Setpoint Schedule file	179
Setpoint Schedule Pool.....	180
Setup/Edit Setpoint Schedule in Pool	181
Setpoint Schedule Properties	183
SEQUENCES.....	184
Create/Edit Sequence File	184
Sequence Pool.....	186
Setup/Edit Sequence in Pool	186
Sequence Properties	188
ON-LINE MONITORING	189
Overview	189
Enter Monitor Mode	190
Visual Indicators for Monitor Mode	191
Monitor Update Rate.....	192
Monitor Toolbar.....	192
How Do I Start Monitoring.....	193
Right Click Procedure in Monitor Mode	194
Function Block Monitor Window.....	195
Forcing/Unforcing an Output.....	196
Forced Blocks Window	198
How Do I Stop Monitoring	201
Logic Flow.....	201

WATCH SUMMARY WINDOW	208
Overview	208
Find Feature.....	210
Sort Function.....	210
Watch Summary - User Defined	210
Watch Summary - Signals	212
Watch Summary - Variables	214
Watch Summary - Inputs/Outputs	215
Watch Summary - Display Groups.....	216
DIAGNOSTICS	219
Controller Diagnostics	219
Controller Diagnostics Status Indications	221
Rack Diagnostics	227
Rack Diagnostics: Power Supply	230
I/O Module Diagnostics Status Indications	231
I/O Channel/Sensor Status	233
Controller Ports Diagnostics	235
Modbus Master (Serial) Port Diagnostics	248
Modbus Initiator (TCP) Port Diagnostics.....	251
REPORTS	255
Print Report.....	255
Print Report Preview	261
Export Report.....	262
MODBUS REGISTER ADDRESSES	265
Modbus Map Overview	265
Configure Modbus Map Method.....	265
Modbus addressability of principal function blocks	267
Fixed Modbus Map	268
Custom Modbus Map.....	271
Adding function block parameters to custom map	276
Adding system parameters to custom map.....	279
REDUNDANCY	281
Redundancy System Status Indicators	281
Redundancy Link Status Indicators	282
Lead CPU Status Indicators.....	283
Reserve CPU Status Indicators	286
Scanner 2 Link Status Indicators	287
INDEX	289

Software Introduction and Overview

Introduction

The Controller and Operator Interface configurations are performed using HC900 Process Control Designer software on a PC operating with Windows™ XP, Vista or Windows™ 7 Operating Systems.

Easy-to-use Windows™-based software, operable over Ethernet or via an USB to RS 485 adapter or modem connection, simplifies controller and operator interface configuration. It provides advanced monitoring functions for debug, uploads the complete, annotated graphic controller and operator interface configuration, and supplies an array of printouts for enhanced documentation.

In some instances, an On-line configuration download capability allows configuration changes such as block additions or block substitutions to be made without switching the controller to program mode, avoiding initialization.

Once a configuration is installed into the controller and operator interface, the software may be used to develop or change recipes, edit data storage schedules, monitor areas of the configuration to verify proper operation, or perform calibration functions.

Features

- Graphic drag and drop, soft-wire configuration
- Supports on-line configuration changes
- Configuration upload that includes graphic configuration to recreate the function block diagram and OI assignments
- Configures Controller and Operator Interface in an integrated environment
- Configures View OI data storage, e-mail alarms
- Configures recipes (Variables only), SP profiles, SP schedules, sequences with on-line operation, provides easy file generation for media transfer to HC900 OI's locally and file management.
- Configuration partitioning using "Worksheets"
- Extensive monitoring tools including watch windows, concurrent detailed block parameter windows, digital/logic power flow via color coding, live data at block pins, and a signal traceback facility
- Windows™ XP, Vista, Windows™ 7 support
- Use Ethernet or RS 485 to access controller

Worksheets

Worksheets are a logical partition of a configuration and selected by tabs that appear on the Main Window.

A configuration is built using four main elements (or Worksheets) of configuration.

The user-friendly graphic development environment allows partitioning of the control strategy into up to 20 or 40 "worksheets" of 20 pages each, depending on Controller model. This allows the configuration to be organized according to process function, allows faster configuration access, and improves documentation.

The configuration originator may apply additional security to specific worksheets to prohibit access to proprietary operations while allowing other users to modify unprotected worksheets or generate recipe and data storage files.

Blocks are simply selected from a categorized list, dropped on a selected worksheet page, and soft-wired to other blocks directly or via tag references. Editing tools such as box copy and paste speed development.

With Controller Rev 6.0 and higher, there is also the concept of "Safety" function-block-diagram worksheets (vs. the regular "Process" function-block-diagram worksheets) for controllers that support it. The Safety worksheets allow definition of "Safety-enabled" configurations to run on SIL-compliant controller models. Within Safety worksheets, certain restrictions at both configuration and run-time are

enforced to ensure safety compliance is achieved (See below section on Function Block Configuration development). Note that a reference to a "Safety block" refers to a function block that is placed on a Safety worksheet.

Monitoring

On-line monitoring tools allow quick analysis of execution problems. These include:

- Multiple function blocks monitor access on a single display from multiple worksheets. Most internal parameters are available for read/write plus block outputs may be forced including I/O and logic blocks. Major blocks such as PID, Setpoint Programmer and Sequencers have dialog boxes to allow operation and test. Stored profiles or sequences may also be selected on-line.
- User-selected Watch Window lists allow access to digital and analog I/O, Signal Tags, Variables (for write actions), and custom display data groups by tab selection. A user-defined watch window provides custom association of parameters for a debug session. Watch windows also allow write (or force) capability.
- Logic power flow indication using color-coded soft wiring for digital connections to and between block pins including signal tags and connectors
- Live data at block pins (analog floating point or digital status) on a complete block or pin basis.
- Signal Trace-back, for any input to a block, for finding the signal sources for quick identification of potential errors.
- A Forced Blocks window shows all forced outputs and allows release of force conditions individually.
- Data update selection as fast as 250 ms.
- Retention of monitoring setup when moving back and forth between editing and monitoring modes.

The user-selected, dockable Watch Window lists and Signal Trace-back finds the signal sources and provides a clear view of the configuration operation allowing quick identification of potential faults.

Read/write interaction is provided for most blocks including PID, Setpoint Programmer and Sequencers.

A FIND function allows location of multiple instances of specific tags, variables, and function blocks across all worksheets. A right click on any signal tag also allows selection of a "Find Where Used" listing for fast access to tag destinations and return to the tag source.

Configuration Download

Configuration download capability (Hot Start) allows configuration changes such as block additions or block substitutions to be made, with restrictions, without switching the controller to program mode, avoiding initialization (Cold Start). Corrections or additions are executed shortly after download – within 3 normal scan cycles. For scan information, refer to the HC900 Controller Installation and User Guide.

Operator Interface Configuration (for Legacy 559/1042 OI)

Configuration of the Operator Interface is an integral part of the controller configuration. Controllers that have been configured with Operator interface data provide the necessary display format data. This unique attribute guarantees compatibility of the controller and user interface databases and greatly simplifies product maintenance.

Designer configuration software uses the database of the function block control strategy to develop operating displays for the Operator Interface. A large selection of display templates is provided that may be assigned quickly and easily to the Operator Interface.

Additional Software Functions

In addition to creating displays and defining display access, Designer software allows users to set up data archiving schedules, develop recipes, create alarm grouping, establish operator security and define a number of other operator interface attributes.

Documenting your configuration is supported through a variety of printable presentation formats. A few of these include a summary of the controller I/O, the graphic configuration diagram, function block

properties, recipe groups, setpoint profile groups, Operator Interface display and point selections, among others.

Recipe/Data Storage File Generation

Recipes and data schedules may be defined within the configuration and/or created as files (via File New) for external file transfer to HC900 operator interfaces or for file management.

Reports

Documenting your configuration is supported through a variety of report formats. Each can be print-previewed. A few of these include a summary of the controller I/O used, function block worksheet selection (each page of diagram worksheet printed as 8.5 x 11" sheet), function block properties, variable and tag parameters, Modbus addresses, Data Storage Settings, recipe listings, setpoint profile listings, sequencer listings, setpoint scheduler listings, OI display groups, Alarm and Event Groups, and controller setup.

Function Block Configuration development

Function Block configuration development is performed using "Drag and Drop" techniques for positioning graphic icons on a FBD Worksheet from a list of available functions. Once dragged and dropped from the Item list onto any FBD worksheet, you can double-click on a block and open a Properties page in which you can configure the specific parameters of that block.

Signal flow connections from icon to icon form the flow of the control strategy by using either software connections or named tags to complete the controller configuration.

Depending on controller model, you can create up to 20/40 graphic diagrams, 1 page high by 20 pages wide. The completed diagram may be printed on pages of 8.5" x 11" paper.

With Controller Rev 6.0 and higher, there is also the concept of "Safety" worksheets (vs. the regular "Process" worksheets) for controllers that support it. The Safety worksheets allow definition of "Safety-enabled" configurations to run on SIL-compliant controller models. On a Safety worksheet, certain restrictions related to safety may be active:

- Only the function block types that are supported by the SIL-compliant controllers may be placed on Safety worksheets. Others will be grayed out in the Toolbox when a Safety worksheet is active.
- There will be strict data-flow restrictions. Generally, the restriction is that data can flow from items on a Safety worksheet to items on Process worksheet, but not vice-versa. This means that setting up data-flows using Connectors, Page-Connectors, and Signals will be restricted to allow only one-way data flows.
- For some function block types, their functionality will become restricted to adhere to the above mentioned data-flow rule. An example is the Write Constant block, which, if placed on a Process worksheet, will not be allowed to be configured to write to a block on a Safety worksheet.
- The data flow restrictions will not only be applied at configuration time, but will be applied at run-time as well (in the controller). For example, SIL-compliant controllers will not allow other controllers to write into blocks in the Safety worksheets using the Peer Data function blocks.

Hardware and Software requirements

Specification	Description
PC Requirements	CPU: 1 GHz (2.5 GHz preferred) Operating System: Windows™ XP onwards Display Color: Minimum resolution (256 color x 1024 x 768 resolution) Pointing Device: Mouse, Trackball or compatible device RAM: > 1GB (512MB preferred) Disk Drive: CD & DVD Drive Ports: USB (2.0 & 3.0)/ Ethernet
System Interconnection	Connected to the controller through its Ethernet 10/100 Base-T ports, RS232 Port, or RS485 port. Cable Termination: 10/100 baseT RJ45
Configuration	Off-line Configuration or, with restrictions, make incremental configuration changes and download them to the controller without taking the process off-line. On-line Monitoring allows the user to test the developed configuration.

What to Know Before You Start

Rack, Module, and Channel Assignments

The controller contains one or more racks. Each rack may contain one or more I/O modules of various types and each I/O module contains a number of channels. Each rack, module and channel is assigned a number in the configuration that corresponds to a physical location in the installed racks.

Before starting, determine the I/O content of the controller racks. Although configurations can be constructed using default I/O locations, the recommended configuration approach is to first verify that the proper I/O is available to execute the desired configuration, and to record the location of each I/O Rack, Module, and Channel so that they may be properly entered during configuration file development.

Please note that expansion racks **ARE NOT** permitted on the HC900-C30 controller.



To allow for and facilitate future expansions and modifications, it is usually a good idea to leave some I/O module slots vacant in each rack, since in software configuration of the I/O, the identification of each I/O point depends on the physical position of the I/O hardware (Rack #, Module #, and Channel #). If all module slots in a rack are full, addition of one I/O module to a given rack could require hardware and software modifications for one or more other I/O Racks in the system.

The [function blocks](#) that deal with reading input channels and/or writing to output channels are categorized as [I/O Function Blocks](#) (with the exception of the [Three-Position Step Control](#) block which is considered a Loop Function Block). These function blocks all have one or more I/O address properties that must be configured through the block's properties dialog. The rack, module and channel numbers assigned to the block's I/O address properties are displayed on the block's graphic as a series of 3 two-digit numbers separated by decimals, as shown below.

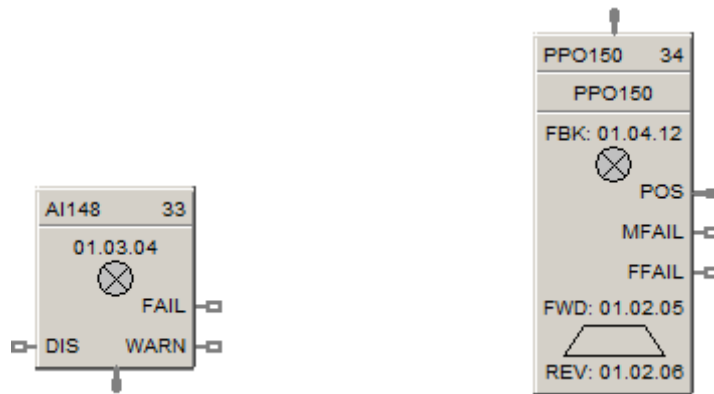

In the above diagram, the AI148 [Analog Input](#) function block has a single input channel configured as:

Rack 01
Module 03
Channel 04

The PPO150 [Position Proportional Output](#) function block has 1 analog input and 2 digital output channels configured as:

Feedback	Forward Relay	Reverse Relay
Rack 01	Rack 01	Rack 01
Module 04	Module 02	Module 02
Channel 12	Channel 05	Channel 06

Implementation

Starting the Application

When the application is started, the only viewable parts are the File Browser and the Worksheet Toolbox.

Go to the **Main Toolbar** or the **File Menu** and select:



or NEW - Displays a "Choose a New File Type" dialog box with three tabs.

New Configuration:

Select the "**Configuration**" tab. From the drop-down menus, select Controller and Revision. Click OK and a new Designer Configuration file is listed in the File Browser and a new diagram is placed in the Main Window area.

New Recipes:

Select the "**Recipe**" tab. On the tab, click on a radio button to select one of the following:

Recipes (Variables)

Setpoint Profile

Setpoint Schedule

Sequence

Click OK. The associated "Editor" dialog box will appear and a new "Opened Recipe File" is listed in the File Browser. Refer to the specific Recipe type for specifics.

New Data Storage (Legacy feature for 559/1042 OI):

Select the "**Data Storage**" tab. On the tab, click on a radio button to create a new Data Storage File

or



or OPEN - Displays the "Open" dialog box.

From the "Files of Type" drop-down menu, select a file type.



Navigate to folder where the file is stored.

Click on the desired file name, then click "OPEN".

or



or Upload (Configuration) - The Upload File dialog box will appear. A temporary file name will be placed in the "File Name" box.

Check the current connection. This will indicate over which communications port the upload will occur. Change the current connection, if necessary, prior to beginning the upload.

Press "START". The dialog box will show "Percent Complete".

The Uploaded Configuration File (.cde) will appear with a temporary file name.

From the "File" menu, select Save or Save As and enter a file name and path in the appropriate fields.

or

Connecting the PC to the Controller

The PC can be connected to the Controller by:

- Direct Serial RS-232 connection
- Modem connection via Remote Access.
- Direct Ethernet connection
- Networked Ethernet connection

For details refer to the HC900 Controller Installation and User Guide, document 51-52-25-154, section "Connecting the HC900 Controller to a PC with the Designer Software."

User Interface

User Interface Overview

The main components of the User Interface are:

Main Menu

Main Toolbar

Worksheet Window(s)

File Browser

Worksheet Toolbox Window

Status Bar

Main menu

Main toolbar

File browser

Worksheet
toolbox
window

Status bar

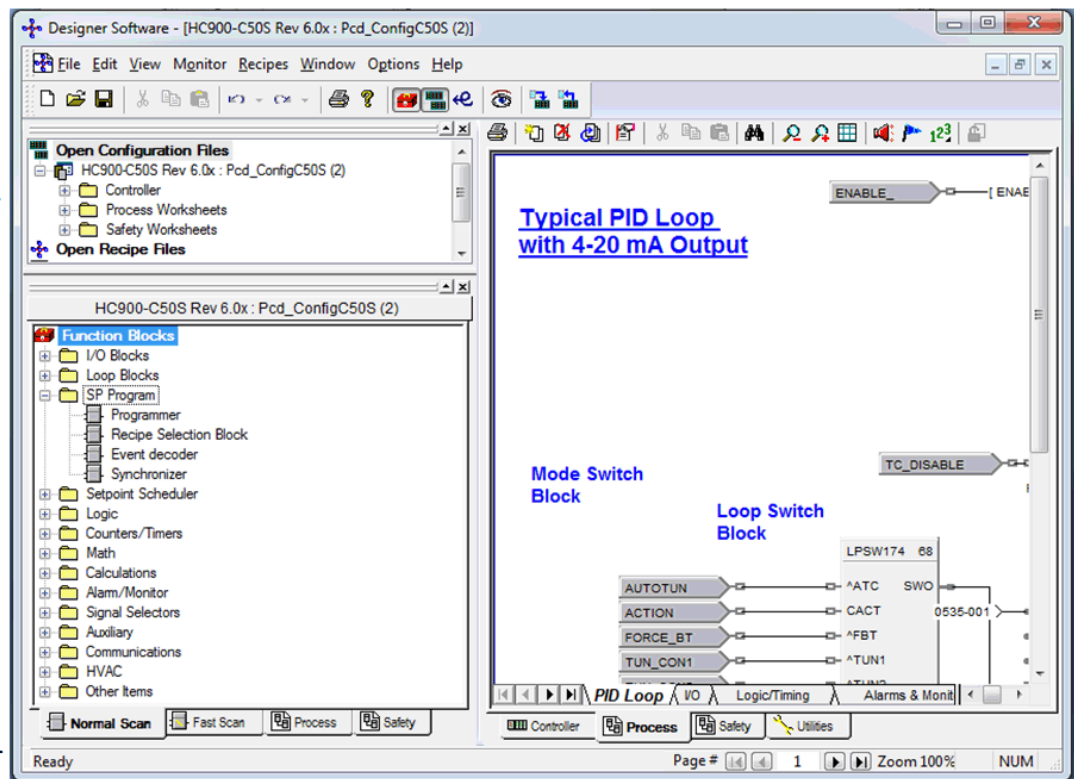

Worksheet window(s)

General Terminology

Term	Definition
Browser	Defaults to the top left side of the Worksheet is a dockable window listing opened files. It allows you to move quickly between files and worksheets.
Configuration Files	A Configuration File contains a Control Strategy that you have created best suited for your application. All Open Configuration Files appear in the Browser Window
Recipe File	A Recipe File refers to one of 4 types of user files – a "Recipe" file consisting of Variables only, a Setpoint Profile, a Setpoint Schedule, or a Sequence.
Data Storage File	A Data Storage File contains a data storage schedule for loading at the operator interface via storage media.
Function Blocks	A Function Block is a unit of software that performs a set of operations on its <i>Input Signals</i> and <i>Function Block</i> parameters and produces <i>Output Signals</i> . These output signals can be configured as inputs to other blocks, whose output parameters can be configured as inputs to other function blocks, and so on.
Main Window	The Main Window contains Menus, toolbars and worksheet window plus other items that help you navigate through the application.
Menu	The Main Menu is a top-level menu for this application. You select (highlight) a menu and then choose a command from the drop-down menu. Choosing the command carries out the action.
Status Bar	The status bar is located along the bottom of the window. It indicates information about the current window, the time, the date, download, upload, monitoring and network information. This status bar can be displayed or not displayed from the "View" menu.
Tab	A configuration is built using three main worksheet types: Controller, Display, and Function Blocks. Select the desired tab, located at the bottom of the configuration window for type of worksheet. There are also Tabs in the Function Block Diagrams that allow you to navigate around the multiple FBD Worksheets.
Toolbox	The Worksheet Toolbox, located on the lower left side of the Worksheet, is a dockable window and lists all the function block by category separated by fast and normal scan tabs at the base of the toolbox. You can drag and drop function blocks onto FBD worksheets. A Configuration Tab lists all configured items. Click on any item to jump to it.
Trace Window	Helps you find problems with soft-wire and signal connections between Function Blocks.
Watch Summary Window	The Watch Summary window lets you monitor the following groups of data from the controller: Signal, Variables, I/O. OI Display Groups.
Worksheet	A Worksheet is a logical partition of a configuration. A configuration is built using three main Worksheet) types: Controller, Display (for Legacy 559/1042 I/O configuration), and Function Blocks. A fourth worksheet type (Utilities) included Maintenance functions for the controller.

File Browser Window

The File Browser Window is a dockable window listing open [Configuration Files](#), [Recipe Files](#), [Data Storage Files](#) and [Backup Files](#), as show below. It allows you to move quickly between open files and individual worksheets within configuration files. You can collapse or expand the tree branches and you can enlarge or shrink the size of the window.

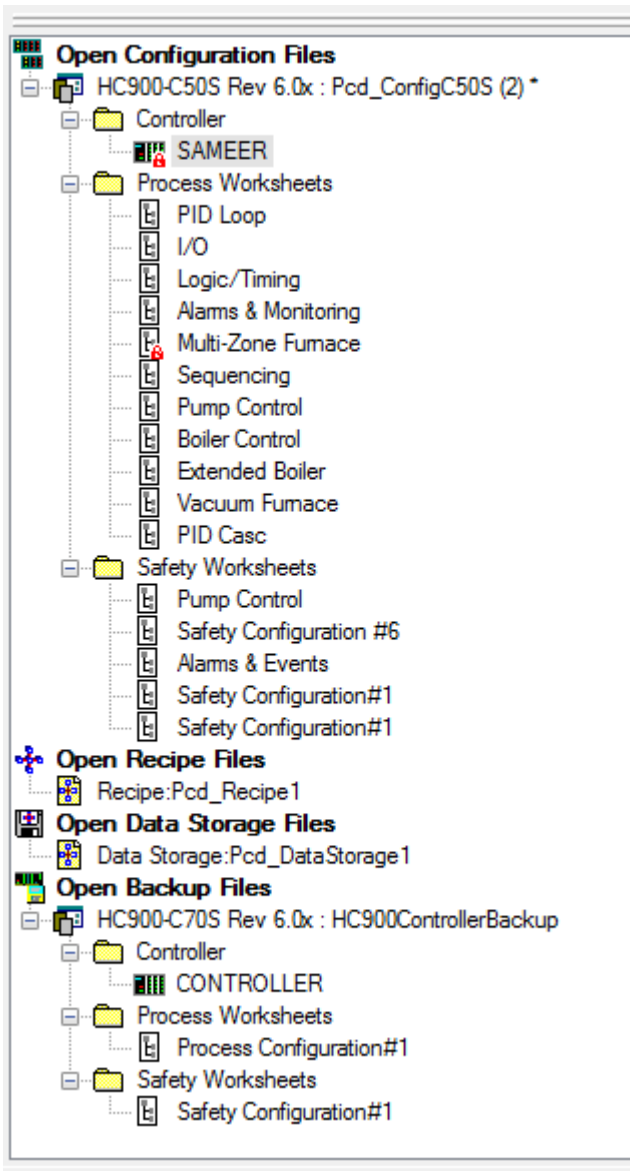

- Right-click on any open file name to make it the active document in the Worksheet Window.
- Right-click on any open file and select **Close File** from the context menu to close it.
- Right-click on a **Configuration** or **Backup** file name and select **Properties** from the context menu to view the file properties.
- Expand the branches under any **Configuration** or **Backup** file name to display the currently configured worksheets. A red lock displayed in the worksheet icon indicates that the worksheet is write-protected.
- Double-click on a worksheet in the browser to make it the active view in the Worksheet Window.
- Right-click on a worksheet to view its context menu. The options available on the context menu will depend on the type of worksheet and the current protection status but may include:
 - Worksheet Properties
 - Unlock Worksheets
 - Print Worksheet
 - Append New Worksheet
 - Delete Worksheet
 - Reorder Worksheets

The File Browser Window can be undocked from its default location to the top-left of the Worksheet Window and moved to another location by dragging and dropping on the bar above the tree view. It can also be hidden or made visible by toggling the state of the  **File Browser** option available from:

- The [Main View](#) menu
- The [Main Toolbar](#)

- The [worksheet context menu](#) View sub-menu

Worksheet Toolbox Window

The Worksheet Toolbox is a dockable window which provides two main functions:

- Categorized library of available function blocks and other items that may be placed on function block worksheets.
- Categorized library of all function blocks, [variables](#) and [signal tags](#) currently in use on all worksheets, providing easy access to properties and navigation to the containing worksheet.

You can collapse or expand the tree and you can enlarge or shrink the size of the window.

This toolbox applies to the current active document and the **name of the active configuration appears on a button at the top of the window**. Click on this button to view the active configuration's file statistics.

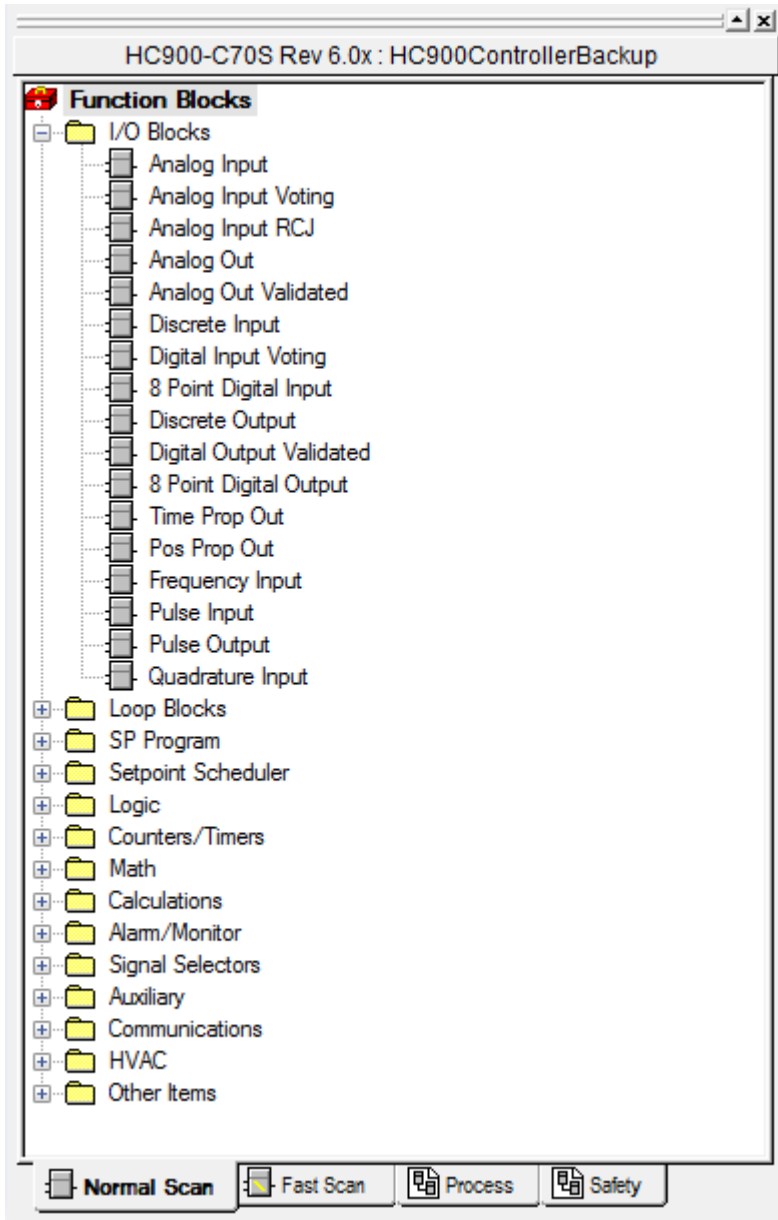

The Worksheet Toolbox contains a tab control with either 3 or 4 tabs. The first two tabs contain the library of available function blocks grouped by the rate that they will be executed at, either [Normal Scan](#) or [Fast Scan](#), as shown below.

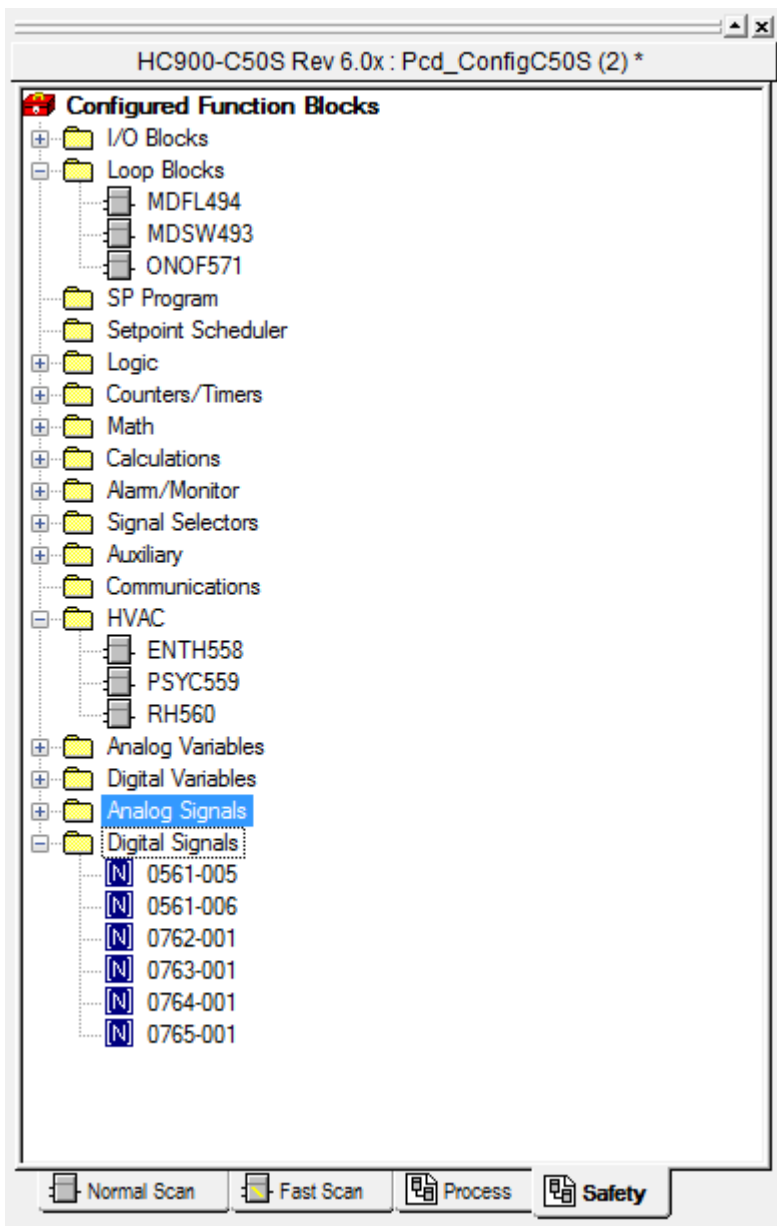

- Click on a tab to display the function block categories available for that scan rate.
- Expand each category to display the available function blocks. For Safety Enabled SIL-compliant configurations some function blocks are not compatible with [Safety Worksheets](#) and will be disabled and grayed-out if the current active worksheet is a Safety Worksheet.
- If the current active worksheet is a Function Block Worksheet, drag and drop any enabled function block to place it on the worksheet.
- Right-click on a function block and select **Help** from the context menu to display a help file page with the details of that block.

The third and optional fourth tabs contain the library of function blocks currently in use, grouped by the type of function block worksheet, either [Process](#) or [Safety](#), as shown below. (The Safety tab will only be available in SIL-compliant configurations.)



- Click on a tab to display the function block categories available for that worksheet type.
- Expand each category to display the function blocks used. The blocks will be identified by the [Function Block ID](#) and the assigned Block Number rather than function block type. The  icon indicates a [Normal Scan](#) rate block and the  icon indicates a [Fast Scan](#) rate block.
- If the configuration is using a [Custom Modbus Map](#), items can be dragged and dropped on to the corresponding [Custom Modbus Map](#) configuration dialog.
- Right-click on an item to display its context menu and select from the following options:
 - **Properties...** to open the item's properties dialog
 - **Block Execution Order...** to change the relative execution order of function blocks
 - **Find** to navigate to the item's location on the worksheet
 - **Help** to display a help file page with the details of that item

The Worksheet Toolbox can be undocked from its default location to the bottom-left of the Worksheet Window and moved to another location by dragging and dropping on the bar above the tree view. It can also be hidden or made visible by toggling the state of the  **Worksheet Toolbox** option available from:

- The [Main View](#) menu
- The [Main Toolbar](#)
- The [worksheet context menu](#) View sub-menu

Traceback Window

Overview

This feature helps you find problems with soft-wire and signal connections between Function Blocks.

For Example:

If you are testing a configuration that you've built and want to know why a Digital Output is ON when it should be OFF, you can search for the source of the Input Signal.

Traceback is useful for finding the analog or digital source signal.

Trace Window

Access the Trace Window from the Main Menu Toolbar



Or, from the View Menu on the main menu.

Function Block	Tag Name	I/O Pin	Worksheet Name
SW126		OUT	#5 - FV's :
PID123	LOOP 3	PVI	#4 - Loops :
MDSW154		MDRQD	#3 - startup :
PID113	LOOP 1	MDRQI	#4 - Loops :
NOT156			#3 - startup :
SPS109	SPS109	~SET	#2 - setpoints :
SPS109	SPS109	SP1	#2 - setpoints :
PID113	LOOP 1	RSP	#4 - Loops :

It is a dockable, sizeable window.

The Trace Window provides a list of all blocks/pins you have traced and lists :

- Block ID
- Tag Name
- I/O Pin Name
- Worksheet name

Trace Window Update

Each time you perform a Trace, the window will update with a new pair of block/pins.

The **first item** is the **signal source**, the **second item** is the **signal destination**.

Select any of the rows in the Traceback window to recall the diagram to display the selected block.

The last trace is on the top of the list.

Right Mouse Click Procedure to Trace Signals

Select a Function Block of interest.

Right Mouse click on any INPUT pin.

Select "TRACE". Traceback will "find" the source of the connection you selected and refresh the FBD view with that block visible (Highlighted) - even if the other side of the connection is on a **different** worksheet.

The Output pin of the block (the signal source) will be displayed in RED.

From that block, repeat the traceback to another block and another block, etc.

Use the Traceback list to view your Traceback history.

You can clear the Trace List by pressing the bar at the top of the window.

Watch Summary Window

Overview



accesses the Watch Summary Window from the Monitor Toolbar

Or, the menu item "Watch Summary" from the Monitor Menu on the main menu.

This is a view of the Watch Summary Window. It is a Dockable (movable), sizable window.

[Press and hold the CTRL key down to prevent Docking when moving the window]

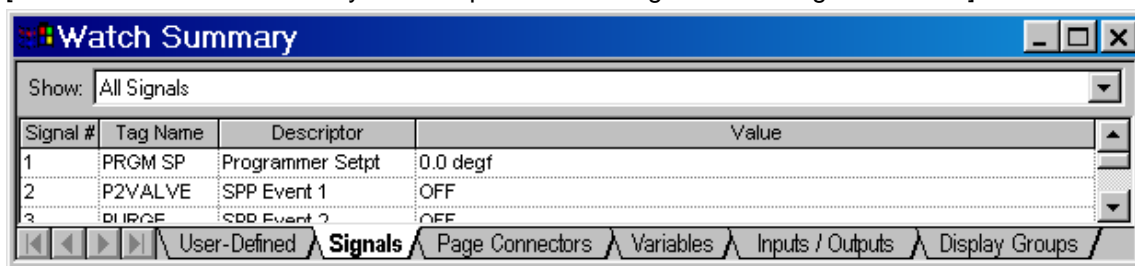

There are five tabs at the bottom of the window that lets you monitor the following groups of data from the controller. Click on any of the tab titles below **to view an example** of the selected data for that tab. All parameter listings may be **sorted** by column.

User Defined (Customized list of Variables, Signal Tags, Page Connectors)

Signals (can be filtered by type - All, Analog, Digital)

Page Connectors (can be filtered by type - All, Analog, Digital)

Variables (can be filtered by type - All, Analog, Digital)

I/O (can be filtered by type - AI, AO, DI, DO)

OI Display groups (Overviews, Panel Meters, Alarms, Trends, etc)

Docking and Undocking the Window

Double clicking in the Title Bar area of the Watch Summary Window will toggle its docked state. If the window is docked, double clicking in the title bar area will undock the window.

If the window is Undocked

- double-clicking in the title bar area will dock the window at it last docked position

- Dragging the window to the top, bottom, left, or right edge of the main viewing area of the application will dock the window at that location

[Press and hold the CTRL key down to prevent Docking when moving the window]

Hot Links

You can click on any I/O function block or Signal on the Controller Worksheet or any I/O function block, Signal, or Variable in the Watch Window and that item will be located on the Function Block Diagram.

As you move the mouse over a HOT LINK, the text changes to Underlined Blue and the cursor

changes to a Hand. 

Writes or Forces

By clicking on the item in the Value column, you may write a value such as for a Variable or force a value for an analog input or digital input. For I/O, a Forced column will indicate that the I/O point is forced.

Status Bar

The status bar is located along the bottom of the application's window. It indicates information about the current window. It can be turned on or off in the "View" Menu.

Menu Item Description - The text string at the far left on the status bar gives a brief description of the menu item in focus. If you pull down a menu list and position the cursor on a menu item this field will describe the menu item.



Connected Field - To the left of the Page Number indicator are two fields that are visible when you are in Monitor Mode. One indicates "Connected" and the other is a green LED that flashes when communications is active between the PC and controller.

Worksheet Page Number -To the left of the Zoom indicator is a page number field. This will display the page number of the **current FBD Worksheet**. It is blank for other worksheet types (Display, Controller, and Utilities). There are scroll buttons to navigate through pages of the worksheet.

Zoom Level – indicates the level of Zoom active on the worksheet. (i.e 100%)

Active Keyboard Keys - Toward the far right, you will see indicators to alert the user that the Caps Lock key on the keyboard is active , the NUM lock on the keyboard is active, or the SCRL (Scroll Lock) key is active.

Menu Conventions

The following menu conventions are used.

Menu Convention	Meaning
Dimmed command	You will not be able to use this command at the current time. (For example: You may need to select another item before using this command.)
An ellipsis (...) following a command	A dialog box will appear when you choose this command. The dialog box contains options you need to select before the command can be completed.
A check mark next to a command	The command is in effect. When you remove the check mark (by selecting the command), the command is no longer in effect.
A key combination next to a command	The key combination is a keyboard accelerator <i>shortcut</i> for this command. You can use this key combination to choose this command.
A triangle next to a command	When you choose this command, a cascading menu appears, listing additional commands.

Selecting a Menu

In this application, you select (highlight) a menu and then choose a command from that menu. Choosing the command carries out the action.

To choose an item from a selected menu:

Mouse

Using the mouse pointer, point to the name of the menu on the menu bar, and click the left mouse button. This opens the menu. To move directly to a menu item, drag the selection cursor down the menu until the desired item is highlighted, then release the button.

UP/Down Arrow Keys

Press the "ALT" key to highlight the menu bar then use the UP/Down arrow keys on the keyboard to select the item, then press "Enter".

Underlined Letter

If a name in the menu bar has an underlined letter you can press ALT and then type the letter that's underlined to open the menu.

For example: to open the FILE menu in the Designer main window, press ALT+F.

Closing a Menu

To close a menu:

Click the menu name or anywhere outside the menu, or







Press ESC to close the menu but remain on the menu bar so that you can make another selection

Main Menu

The Main Menu is located across the top of the User Interface. The menus are:

- File Menu
- Edit Menu
- View Menu
- Monitor Menu
- Recipes Menu
- Window Menu
- Help Menu

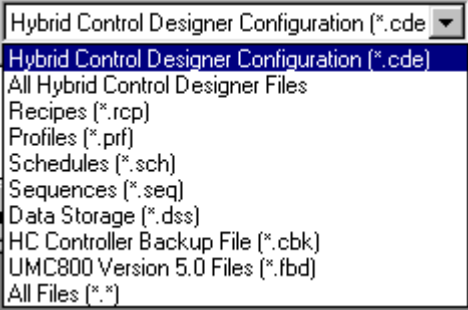



File Menu

Menu Selection	Function
<p><u>N</u>ew</p>  <p>Toolbar: </p> <p>Shortcut: CTRL+N</p>	<p>Displays a "Choose a New File Type" dialog box with these tabs:</p> <p>New Configuration: Select the "Configuration" tab. From the drop-down menus, select Controller and Revision. Click OK and a new Configuration file is listed in the File Browser and a new diagram is placed in the Main Window area.</p> <p>New Recipes: Select the "Recipe" tab. On the tab, click on a radio button to select one of the following: Recipes (Variables) Setpoint Profile Setpoint Schedule Sequence</p> <p>Click OK. The associated "Editor" dialog box will appear and a new "Opened Recipe File" is listed in the File Browser. Refer to the specific Recipe type for specifics.</p> <p>New Data Storage: Select the "Data Storage" tab. On the tab, click on a radio button to create a new Data Storage File</p>
<p><u>O</u>pen ...</p>  <p>Toolbar: </p> <p>Shortcut: CTRL+O</p>	<p>Displays the "Open" dialog box. From the "Files of Type" drop-down menu, select a file type.</p>  <p>Navigate to folder where the file is stored. Click on the desired file name, then click "OPEN". Opens files and converts UMC800 (*.FBD) configuration files.</p>
<p><u>C</u>lose</p>	<p>Closes the active document window. It will also close a minimized window if active. [It will not close an active dialog box.]</p>
<p><u>S</u>ave</p>  <p>Toolbar: </p> <p>Shortcut: CTRL+S</p>	<p>Saves the active configuration. First time save displays the "Save As" dialog box.</p>
<p><u>S</u>ave <u>A</u>s ...</p>	<p>Displays the "Save As" dialog box. Prompts user to name the active configuration and select the file in which the file is to be stored.</p>

Menu Selection	Function
Download	<p>Configuration Download transfers a saved configuration FROM the PC TO the controller.</p> <p>The Controller may be in either RUN or PROGRAM mode.</p>
Upload Configuration	<p>Configuration Upload transfers a configuration FROM the controller TO the PC including graphic function block pages, text annotations, stored recipes/profiles/schedules/sequences, OI display assignments, OI data storage setup. The uploaded file name, as a default, will include the controller name, alias name (if assigned) and network name (if assigned).</p> <p>The Controller may be in ANY mode.</p> <p>No configuration file is required to be opened prior to the Upload Request</p>
Upload...	<p>Opens the "Upload" dialog box that lists the type of recipes available to upload.</p> <p>Click on a radio button to select one of the following:</p> <ul style="list-style-type: none"> Recipes (Variables) Setpoint Profile Setpoint Schedule Sequence Data Storage. <p>Upload transfers a recipe FROM the controller TO the software.</p>
Back up Controller...	<p>Saves a controller's active configuration as a backup file with .cbk extension. Similar to saving an uploaded configuration except that the configuration <i>and</i> port settings are saved. You are prompted to specify the comm. link settings for the controller to be backed up. Backup files are read-only; to edit you must first save as .cde. See Back Up Controller Information for more details.</p>
Hang Up Modem	<p>When communicating with a controller via a Modem, select this to disconnect the Modem from the controller.</p>
Properties ...	<p>Displays the "<u>File Properties</u>" dialog box.</p> <p>Tabs allow user to fill in Configuration File properties, read Configuration File Statistics (capacity usage), read protection, and worksheet protection (password access to individual worksheets)</p>
<u>W</u>rite Protect File ...	<p>Displays the "<i>Add Write Protection</i>" dialog box.</p> <p>Can enter and confirm a password for the selected file. Use the check box to turn "Write Protect" on or off.</p>
<p><u>P</u>rint Report</p> <p>Toolbar: </p> <p>Shortcut: CTRL+P</p>	<p>Displays the "Print Report" Dialog box.</p> <p>Lets you choose reports for printing from 5 different categories:</p> <ul style="list-style-type: none"> Controllers Function Block Diagrams Displays Recipes Alarms and Events

Menu Selection	Function
Print Report Preview	Lets you choose a report preview (Print Preview) for printing from the 5 categories: Controllers Function Block Diagrams Displays Recipes Alarms and Events The selected report is displayed on the screen as it will look when printed.
Export Report	Lets you export reports as files in comma or tab separated format.
Print Setup ...	Displays " <i>Print Setup</i> " dialog box. Allows user to select printer, paper type, and orientation.
Most Recent Files	Lists the most recent files that were open.
Exit	Exits the application.

Edit Menu

Menu Selection	Function
Undo Toolbar:  Shortcut: CTRL+Z	Click once to undo the last action. Click on the down arrow to see all previous actions. To undo several actions, move mouse to an earlier action and click on it: all actions from that action forward are undone. If you accidentally undo an action, use redo. You can undo only actions that affect the contents of the configuration; you can't undo actions that affect the display of the configuration (such as zoom).
Redo Toolbar:  Shortcut: CTRL+Y	Click once to redo the last Undone action. Click on the down arrow to see all Undone actions. To redo several actions, move mouse to earliest desired action and click on it: all actions from that action forward are redone. If you accidentally redo an action, use undo. You can redo only actions that affect the contents of the configuration; you can't redo actions that affect the display of the configuration (such as zoom).
Cut Toolbar:  Shortcut: CTRL+X	Moves the currently selected Process or Safety block diagram items from the current diagram and places them on the clipboard. Indicated by a red dotted line. Upon pasting the items, all links to them (e.g., display references, Modbus address, recipes) are preserved as if they were moved; they are not deleted and pasted as a new copy. The only exception to this is if the item is pasted into a diagram on a different configuration.
Copy Toolbar:  Shortcut: CTRL+C	Copies the currently selected Process or Safety block diagram items from the current diagram, and place it on the clipboard. Indicated by a blue dotted line.

<p>Paste</p>  <p>Toolbar:</p> <p>Shortcut: CTRL+V</p>	<p>Places the contents of the clipboard containing Process or Safety block diagram items onto the Process or Safety block diagram at the location determined by the blinking insertion point caret. This command is unavailable if the clipboard is empty. Cut and pasted items maintain their links (e.g., display references, Modbus addresses, recipes); they are not deleted and pasted as a new copy. The only exception to this is if the item is pasted into a diagram on a different configuration.</p> <p>If you paste a cut (not copied) function block and soft wires to the same or different worksheet in the same configuration, the soft wires will be dangling (unconnected) and you are asked to specify how you want to resolve dangling soft wires.</p>
<p>Delete</p>	<p>Deletes the currently selected item on the function block diagram.</p>
<p>Append Process Worksheet / Append Safety Worksheet</p>	<p>Adds a new Process or Safety block diagram. You will see “Append Process Worksheet” or “Append Safety Worksheet” depending on which tab is currently active. If the Controller or Utilities tab is currently active, this command will be grayed out. If selected when enabled, a new worksheet will be created and a new sub-tab for it will appear at the bottom of the diagram window. The new diagram reference will be placed in the File Browser. Click on the diagram name in the File Browser to edit the name.</p>
<p>Delete Process Worksheet / Delete Safety Worksheet</p>	<p>Deletes the selected Function Block Diagram and its reference in the File Browser.</p>
<p>Reorder Process Worksheets... / Reorder Safety Worksheets...</p>	<p>Opens the Worksheet order dialog box. Allows you to change the order of the worksheets as they appear at the bottom of the Worksheet area. Click on worksheet name and use the increment-decrement buttons at the top of the dialog box to change the worksheet order.</p>
<p>Worksheet Properties...</p>	<p>Opens the "Worksheet Properties" dialog box. Allows you to enter or edit the Title and Description of the worksheet. Type in a title (24 characters) and description (32 characters) for your Worksheet -.</p>
<p>Unlock Worksheets</p>	<p>Displays "Unlock Worksheets" dialog box. Enter password to unlock all protected worksheets. Click on "Unlock".</p>
<p>Block and Tag Order</p>	<p>Opens the " Block Execution Order" or the "Fast Block Execution Order" dialog box to let you re-arrange block execution order.</p> <p>Also available from the Process or Safety worksheet toolbar.</p> <p>Select "Tag Order" to re-arrange the tags order for:</p> <ul style="list-style-type: none"> Alternator Operates Device Controls HOA Switches Loops Ramp Operates Sequencers SP Programmers SP Schedulers Stage Operates
<p>Loop Mode Priority</p>	<p>Opens the Loop Mode Priority dialog box. Lets you select which has priority: Manual Mode or Tracking Mode.</p>
<p>Alarms</p>	<p>Opens the "Alarm Group Configuration" dialog box. Lets you set up or edit alarm groups .</p> <p>Also available from the Process or Safety worksheet toolbar.</p>
<p>Events</p>	<p>Opens the "Configure Event List" dialog box. Allows you to Set up or Edit Events.</p> <p>Also available from the Process or Safety worksheet toolbar.</p>

Configure Modbus Map Type	Available for configuration revision 4.0 or higher. Selects a method for configuring the Modbus register map: fixed or custom. See Configure Modbus Map Method .
Modbus Register Map...	Available for configuration revision 2.0 or higher. Lets you "Edit Fixed Modbus Register Addresses " dialog box.
Trend Backfill Log Point Selection	Available for configuration revision 4.4 or higher. Lets you select method for configuring points to be saved in the trend history buffer either via signal tag name or Modbus address.
Defragment Function Block List	Frees up memory occupied by previously deleted function blocks. After defragmentation is complete, downloading the configuration to the controller requires a cold start. When configuration memory is 100% full but includes fragmented space from deleted blocks, the defragment window appears automatically. To avoid untimely cold starts, we recommended you defragment before configuration memory is full. (See Statistics .)
Find Shortcut: CTRL+F	Searches for an item on the "Find Item" dialog box. Select an item type from the "Show" drop-down menu to search, then select an Item from the "Item" drop down menu. The Tag, Variable, or Function Block will be highlighted on the Function Block Diagram.
Go To Shortcut: CTRL+G	Displays the "Enter Page Number" dialog box and allows you to enter the page number to which you want to go. (1-20)

View Menu

Menu Selection	Function
Toolbar	Displays or hides the toolbar in the top of the Main window. Gray box with √ mark indicates display.
Status Bar	Displays or hides the status bar at the bottom of the Main window. Gray box with √ mark indicates display.
File Browser	Displays or hides the File Browser at the top left of the Main window. Gray box with icon indicates display.
Worksheet Toolbox	Displays or hides the Worksheet Toolbox at the bottom left of the Main window. Gray box with icon indicates display. Tabs separate fast scan and normal scan function block types.
Trace Window	Allows you to view the Traceback list.
Phone Book	Opens the "Select the Number to Call" dialog box. Lets you add and delete phone number on the list.
Network Device List	Lets you setup a PC Network Port for interface to a specific controller. See PC Network Port Set Up .
PC Serial Port Setup	Lets you setup up to 8 PC Serial Comm ports for interface to a specific controller. See PC Serial Com Port Setup .
Grid	Displays or hides a Grid on the FBD Worksheet
Zoom Out	Lets you Zoom in out to see more of a document. Zoom levels of 50%, 75%, 100%, 125%, and 150%. Also available from FBD worksheet toolbar.
Zoom In	Lets you zoom in to return items to normal size. Zoom levels of 50%, 75%, 100%, 125%, and 150%.

Menu Selection	Function
	Also available from FBD worksheet toolbar.

Monitor Menu

Menu Selection	Function
Monitor Mode	Enters or exits monitor mode. While in monitor mode, edits to the configuration cannot be made. If entering monitor mode, selecting this menu item opens the " <u>Enter Monitor Mode</u> " dialog box.
Monitor <u>T</u>oolbar	The Monitor Toolbar toggles each monitor window listed below:
Set Update Rate	You can specify the monitor update rate that determines how often data is collected from the controller during monitoring.
Set Logic State Colors	You can select a color scheme for indicating the on/off status of digital wires, digital signal tags , page connectors , and logic inversion .
<u>W</u>atch Summary Window	Toggles the Watch Summary Window that lets you view groups of related data such as I/O and Signal Tags.
Controller Diagnostics	Toggles the Controller Diagnostics Window that lets you view the controller parameters and values.
Rack Diagnostics	Toggles the Rack Diagnostics window that lets you view the Rack Diagnostics, Expansion I/O Comm Diagnostics(except C30 CPU) and the I/O Module parameters and indicators.
Controller Ports Diagnostics	Toggles the Configuration Port Diagnostics window that lets you view the Configuration Port parameters and values. Serial Port S1 Serial Port S2 Network Port Expansion I/O Comm (except C30 CPU) Host Connections Peer to Peer Connections
Modbus Master Ports Diagnostics	Displays Modbus ports diagnostics. Modbus Master (Serial) Port Diagnostics Modbus/TCP Initiator Port Diagnostics
Monitor Function Block <i>Shortcut: CTRL+M</i>	Toggles the Function Block Monitor Windows that lets you monitor all the parameters of the selected Function Block.
Forced Blocks	Toggles the Forced Block Summary Window that lets you see all the outputs that are being forced and permits release of the force condition for a selected output.
All Function Block Windows	Allows you toggle the function block windows that are open - On/Off.
All Pins	Lets you toggle monitoring values (numeric or On/Off state) at any input or output pin – Display or Hide.
All Monitor Windows	Allows you toggle the Monitor windows that are open - On/Off.

Menu Selection	Function
Redundancy...	<p>Accesses Redundancy diagnostics.</p> <p>Redundancy System</p> <p>Redundancy Link</p> <p>Lead CPU</p> <p>Reserve CPU</p> <p>Scanner 2 Link</p>

Recipes Menu

Accesses all recipe pools. To learn about the different recipe types read Recipe Overview.

Menu Selection	Function
Allocate Recipe Memory	<p>Allocates the controller's memory for the four recipe types. This is the number of recipes that can be stored in the controller's four recipe pools. Recipes in these pools can be loaded and run by Recipe Selection Blocks, Programmers, Schedulers, and Sequencers. As recipe memory usage increases, less memory is available for other parts of your configuration (such as function blocks).</p>
Recipes (Variables)...	<p>A recipe (variables) is a list of Variables with settings that define the ingredients needed to make a product or run a particular batch. This selection opens the Recipe Pool dialog box and allows viewing, adding, editing, and printing of Recipe details. You can save the selected recipe item to a file; open a recipe file and insert it into the pool; and download the selected recipe item to a controller's recipe pool.</p>
Setpoint Profiles...	<p>Setpoint Program (Profile) configuration provides a quick and easy way to create, edit, and save different ramp/soak (setpoint) profiles for the Setpoint Programmer (SPP) control blocks in the configuration. This selection opens the Setpoint Profile Pool dialog box and allows viewing, adding, editing, and printing of Setpoint Profile details. You can save the selected SPP item to a file; open a SPP file and insert it into the pool; and download the selected SPP item to a controller's Setpoint Profiles pool.</p>
Setpoint Schedules...	<p>Setpoint Schedule configuration provides a quick and easy way to create, edit, and save different Setpoint Schedules for the Setpoint Scheduler (SPS) control blocks in the configuration. This selection opens the Setpoint Schedule Pool dialog box and allows viewing, adding, editing, and printing of Setpoint Schedules details. You can save the selected SPS item to a file; open a SPS file and insert it into the pool; and download the selected SPS item to a controller's Setpoint Schedule pool.</p>
Sequences...	<p>Sequence configuration provides a series of inter-related events used to start-up or shut-down a unit process, or a series of timed and process measurement dependent events that are executed to produce a final product. This selection opens the Sequence Pool dialog box and allows viewing, adding, editing, and printing of Sequence details. You can save the selected SEQ item to a file; open a SEQ file and insert it into the pool; and download the selected SEQ item to a controller's Sequence pool.</p>

Window Menu

Menu Selection	Function
----------------	----------

<u>C</u>ascade	Arranges windows so that they overlap making it easy to select a window.
Tile <u>H</u>orizontally	Arranges windows side by side. Each window is visible and none overlap.
<u>T</u>ile Vertically	Arranges windows over and under each other. Each window is visible and none overlap.
<u>A</u>rrange All	Arranges configuration Icons when configurations are minimized.
(Open window designations)	Lists all Function Block Diagrams, recipes, and data storage files that are open and checks the one that is active. Click any file to display it.

Help Menu

MENU SELECTIONS

Help Topics

Calls up the top level Helps Contents page.

Selecting a **Topic** displays information about that topic. If the information about a topic exceeds the height of the window, a vertical scrollbar will be displayed.

Selecting the **Index** tab lets you type in the first few letters of the word you are looking for.

Selecting the **Find** tab lets you search for specific words and phrases in Help topics, instead of searching for information by category.

About Help

Displays copyright and software version, and user name and company name entered during software's installation.

ADDITIONAL HELP ACCESS

Right-click Help for Help Topics







Right-click on any Function Block to access topic help for that particular Block

Hotspots



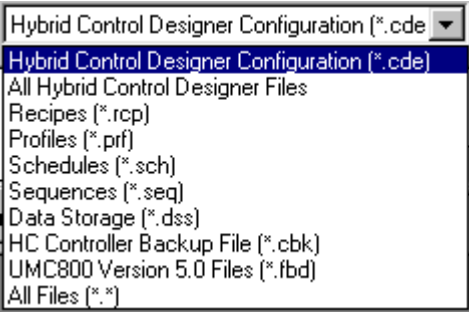







When the cursor is over a hotspot area on an image, it turns to a hand indicating that when clicked some sort of action occurs.

Main Toolbar Functions

Click on ICON to open a dialog box.

ICON	Function	Dialog Box Comments
	New	<p>Displays a "Choose a New File Type" dialog box with these tabs.</p> <p>New Configuration: Select the "Configuration" tab. From the drop-down menus, select Controller and Revision. Click OK and a new Designer Configuration file is listed in the Designer Browser and a new diagram is placed in the Main Window area.</p> <p>New Recipes: Select the "Recipe" tab. On the tab, click on a radio button to select one of the following: Recipes (Variables) Setpoint Profile Setpoint Schedule Sequence</p> <p>Click OK. The associated "Editor" dialog box will appear and a new "Opened Recipe File" is listed in the File Browser. Refer to the specific Recipe type for specifics.</p> <p>New Data Storage: Select the "Data Storage" tab. On the tab, click on a radio button to create a new Data Storage File</p>
	Open	<p>Displays the "Open" dialog box. From the "Files of Type" drop-down menu, select a file type.</p>  <p>Navigate to folder where the file is stored. Click on the desired file name, then click "OPEN". Opens files and converts UMC800 (*.FBD) configuration files.</p>
	Save	<p>Saves the active configuration. First time save displays the "Save As" dialog box.</p>
	Cut	<p>Moves the currently selected FBD diagram items from the current Function Block diagram and places them on the clipboard. Indicated by a red dotted line. Upon pasting the items, all links to them (e.g., display references, Modbus address, recipes) are preserved as if they were moved, they are not deleted and pasted as a new copy.</p>
	Copy	<p>Copies the currently selected FBD diagram items from the current Function Block diagram and places it on the clipboard. Indicated by a blue dotted line.</p>

User Interface
Main Toolbar Functions

ICON	Function	Dialog Box Comments
	Paste	<p>Places the contents of the clipboard containing FBD diagram items onto the Function Block Diagram at the location determined by the blinking insertion point caret. This command is unavailable if the clipboard is empty. Cut and pasted items maintain their links (e.g., display references, Modbus addresses, recipes), they are not deleted and pasted as a new copy.</p> <p>If you paste a cut function block and soft wires to the same or different worksheet in the same configuration, the soft wires will be dangling (unconnected) and you are asked to specify how you want to resolve dangling soft wires.</p>
	Undo	<p>Click once to undo the last action. Click on the down arrow to see all previous actions. To undo several actions, move mouse to an earlier action and click on it: all actions from that action forward are undone. If you accidentally undo an action, use redo.</p> <p>You can undo only actions that affect the contents of the configuration; you can't undo actions that affect the display of the configuration (such as zoom).</p>
	Redo	<p>Click once to redo the last Undone action. Click on the down arrow to see all Undone actions. To redo several actions, move mouse to earliest desired action and click on it: all actions from that action forward are redone. If you accidentally redo an action, use undo.</p> <p>You can redo only actions that affect the contents of the configuration; you can't redo actions that affect the display of the configuration (such as zoom).</p>
	Print	<p>Displays the "Print Report" Dialog box.</p> <p>Lets you choose reports for printing from 5 different categories:</p> <ul style="list-style-type: none"> Controllers Function Block Diagrams Displays Recipes Alarms and Events
	Help Topics	Opens Help Topics Table of Contents and Help information screen.
	Worksheet Toolbox	Displays or hides the Worksheet Toolbox Window.
	File Browser	Displays or hides the File Browser Window.
	Traceback Window	Displays or hides the Traceback Window.
	Monitor Mode	<p>Enters/Exits Monitor Mode and allows On-line Monitoring and Diagnostics.</p> <p>When pressed, the active configuration is in the Monitor mode (and cannot be edited). When not pressed, the active configuration is in the edit mode.</p>
	Download	Opens the "Download File" dialog box. Press start to Download file selected to the controller.
	Upload	Opens the "Upload File" dialog box. Press start to Upload file selected from the controller.

Navigational Tools

Navigational Tools available:

Main Menus and Main Window Toolbar

File Browser Window

Worksheet Category Tabs

Worksheet Toolbars (Controller, Display, Function Block Diagram, Utilities)

Find / Go To

Function Block Help (right mouse click on block)

Connection Traceback Window

Finding an Item on the FBD Worksheet

Hot Links

Keyboard Navigation

Right Mouse Click

Shown below are the right-click menus.

See also Right Click In Monitor Mode.

Right Click On Function Block Object (not pins)

Help - Calls up Topic Help for Function Block selected

Execution Order

Cut

Copy

Paste

Delete

Edit Modbus Register Address

Properties

Right Click On Unconnected Function Block pins*

Signal Tag

Page Connector

Analog Variable

Digital Variable

Numeric Constant

Connector

Paste – Reconnects a signal tag or page connector that you cut from another pin.

*When you drop one of these items it automatically connects to the pin you right-clicked on.

Right Click on Connected Function Block Input Pins

Trace

Right Click on Variable

Help - Calls up Topic Help for Function Block selected

Execution Order

Cut

Copy

Paste

Delete

Add to Modbus Registers

Properties

Right Click on Signal Tag

Help – calls up help

Find Where Used – Opens Find dialog box. Lets you locate any and all places where the signal tag is used.

Cut -- Cuts the signal tag so you can reconnect (paste) it to a different unconnected pin of the same type (digital or analog). Can reconnect to a different function block. Item is grayed out indicating the cut. Press Esc to cancel.

Delete – Deletes the signal tag.

Add to Modbus Registers

Properties

Right Click on Page Connector

Help – calls up help

Find Where Used – Opens Find dialog box. Lets you locate any and all places where the page connector is used.

Cut --Cuts the page connector so you can reconnect (paste) it to a different unconnected pin of the same type (digital or analog). Can reconnect to a different function block. Item is grayed out indicating the cut. Press Esc to cancel.

Delete – Deletes the page connector.

Add to Modbus Registers

Properties

Click On FB Diagram White Space

Cut

Copy

Paste

Drop Other Items

Execution Order

Fast Logic Order

Find

Go To

View (displays the view menu)

Properties [File]

Keyboard Navigation

Press	To
LEFT ARROW	Scroll worksheet to the left
RIGHT ARROW	Scroll worksheet to the right
UP ARROW	Scroll worksheet up
DOWN ARROW	Scroll worksheet down
END	Go to the end of last page
HOME	Go to the beginning of first page
PAGE DOWN	Go to the next worksheet page
PAGE UP	Go to the previous worksheet page
CTRL+LEFT ARROW	Go to the end of last page
CTRL+RIGHT ARROW	Go to the beginning of first page
CTRL+UP ARROW	Go to the top of the page
CTRL+DOWN ARROW	Go to the bottom of the page
CTRL+PAGE DOWN	Go to the next worksheet tab
CTRL+PAGE UP	Go to the previous worksheet tab

Other keyboard functions

If necessary, you can use the standard keystroke conventions to move around.

ALT used together with the underlined letter in text labeling an object lets you select that object.

TAB select next field or object in dialog boxes and configuration templates

SHIFT+TAB select previous field or object in dialog boxes and configuration templates

UP ARROW previous choice in the field

DOWN ARROW next choice in the field

ALT+DOWN ARROW opens a drop-down list box

This page has been intentionally left blank

File Management

Opening an Existing File

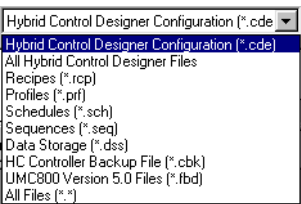
<p>Select "Open" from the File Menu...</p> <p>or</p>  <p>from the Main Toolbar</p> <p>Shortcut: CTRL+O</p>	<p>Displays the "Open" dialog box. Drop-down the "Files of Type" menu and select a file type.</p>  <p>Navigate to folder where the file is stored.</p> <p>Click on the desired file name, then click "OPEN".</p>
<p>or</p>	<p>From the "File" menu, select one of the most recently opened file listed above the "Exit" item.</p>

Creating a New Configuration File

<p>Select "New" from the File Menu then "Configuration" tab from the dialog box</p> <p>or</p>  <p>from the Main toolbar</p> <p>Shortcut: CTRL+N</p>	<p>Displays a "Choose a New File Type" dialog box. Select the "Configuration" tab. From the drop-down menus, select Controller and Revision.</p> <p>Click OK and a new Designer Configuration file is listed in the Designer Browser and a New diagram is place in the Main Window area.</p>
--	--

Saving A Configuration File

To Save an Existing File



1. Select "SAVE" from the "FILE" menu or from the Main Toolbar
2. If there **are no** unconnected inputs that need to be set to OFF or 0, **and** there are no I/O blocks with unassigned I/O addresses, then the data is saved automatically, and the rest of the steps may be skipped.
3. If there **are** unconnected inputs that have not been previously set to OFF or 0, **and/or** there are I/O blocks with unassigned I/O addresses, the Process Control Designer will notify you of the situation and ask if you want to see a list of unconnected inputs and/or a list of unconfigured I/O blocks.

4. Click "Yes" to view the summary of unconnected inputs or unconfigured I/O blocks.
5. Click "Log File" to save the list to a text file, if desired.

To Save a New File or Save the File as a New Name

1. Select "SAVE AS" from the "FILE" menu. The "Save As" dialog box will open.

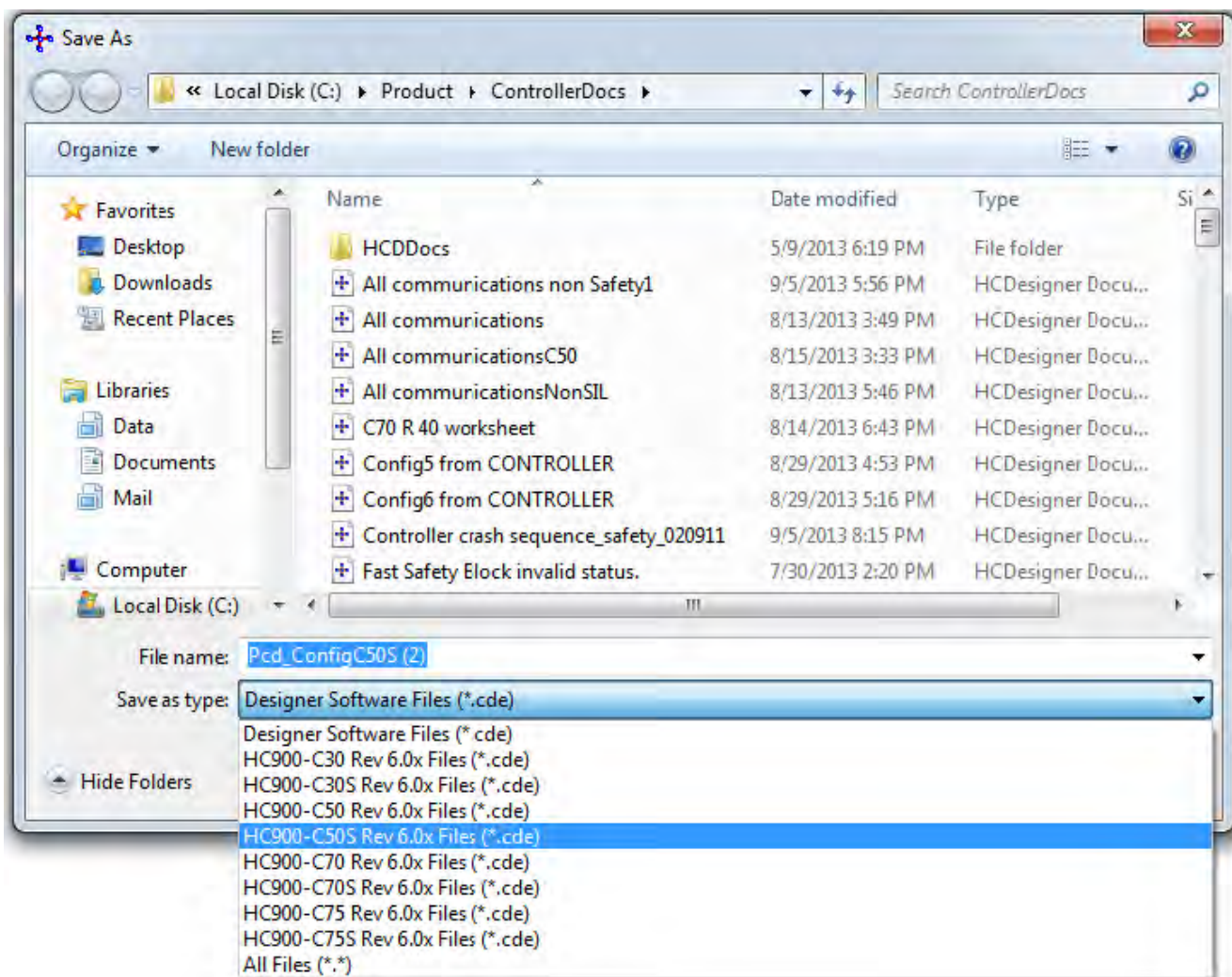

2. Type in the new file name in that field.
3. From the drop-down menu in the "Save as Type" field, select the configuration type depending on the controller you have.
4. If there **are no** unconnected inputs that need to be set to OFF or 0, **and** there are no I/O blocks with unassigned I/O addresses, then the data is saved automatically, and the rest of the steps may be skipped.
5. If there **are** unconnected inputs that have not been previously set to OFF or 0, **and/or** there are I/O blocks with unassigned I/O addresses, the Process Control Designer will notify you of the situation and ask if you want to see a list of unconnected inputs and/or a list of unconfigured I/O blocks.
6. Click "Yes" to view the summary of unconnected inputs or unconfigured I/O blocks.

7. Click "Log File" to save the list to a text file, if desired.

To Save a File as a Different Device or Revision (i.e. conversion)

1. Select "SAVE AS" from the "FILE" menu. The "Save As" dialog box will open.
2. Type in the new file name in that field.
3. From the drop-down menu in the "Save as Type" field, select the configuration type and revision that you wish to convert to.
4. If there **are no** unconnected inputs that need to be set to OFF or 0, **and** there are no I/O blocks with unassigned I/O addresses, then the data is saved automatically, and the rest of the steps may be skipped.
5. If there **are** unconnected inputs that have not been previously set to OFF or 0, **and/or** there are I/O blocks with unassigned I/O addresses, the Process Control Designer will notify you of the situation and ask if you want to see a list of unconnected inputs and/or a list of unconfigured I/O blocks.
6. Click "Yes" to view the summary of unconnected inputs or unconfigured I/O blocks.
7. Click "Log File" to save the list to a text file, if desired.

Note that if you convert a safety-enabled configuration to a non-safety configuration, then all the safety worksheets in the configuration will be converted to process worksheets. Conversely, if you convert a non-safety configuration to a safety-enabled configuration, then a blank safety worksheet will be added to the configuration.

Creating Other File Types

See sections for details.

[Create/Edit Recipe \(Variables\)](#)

[Create/Edit Setpoint Profile](#)

[Create/Edit Setpoint Schedule](#)

[Create/Edit Sequence](#)

[Create/Edit Data Storage Settings](#)

[Back up Controller Information](#)

Converting HC900 Configurations

You cannot download a configuration saved as one HC900 controller model to a controller of a different model. You must first convert the configuration before doing a download.

Conversion Procedure

1. With the configuration file open, select "SAVE AS" from the "FILE" menu. The "Save As" dialog box will open.
2. From the drop-down menu in the "Save as Type" field, select the type of Controller configuration that you want to convert **TO**. (See table below.)
3. Select "SAVE".
4. If there is a problem with the conversion from C50 to C30, the "Conversion Error" dialog box will appear indicating what the error is. For example:
Too many Loop Blocks,
Greater than 400 User Function Blocks,
Expansion Rack used in Configuration.

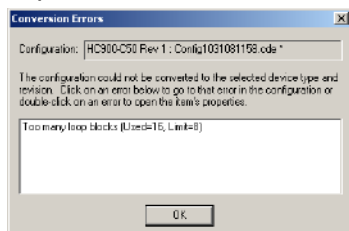

5. If there is no problem, the conversion will proceed.
6. If there **are no** unconnected inputs that need to be set to OFF or 0, the data is saved automatically.
7. If there **are** unconnected inputs that have not been previously set to OFF or 0, the application will notify you that there are unconnected inputs and ask if you want to see a list of unconnected inputs.
8. Click "Yes" to view the summary of unconnected inputs.
9. Click "Log File" to save the list to a text file, if desired.

Note: Configuration for model revisions can only be saved as models of same revision or newer revision. Configuration fails cannot be saved as older configuration revisions.

Start with an "original configuration" and do a File, Save As, and save the configuration to the newer revision (or different controller type).

The new configuration can only be downloaded to a controller of the same type.

* Configuration revision remains the same or is upgraded to a later revision

Uploading a File from the Controller



Introduction

Upload transfers a file **FROM** the controller **TO** the PC. Uploadable files are configurations, recipes, and data storage.

The Controller may be in ANY mode.

No configuration file is required to be opened prior to the Upload Request.

Uploading Configuration

1. From the "File Menu" select Upload Configuration, or click on the Upload icon on the Main Toolbar , or click on the Upload icon on the Utilities Worksheet Toolbar , then select "Upload Configuration".
2. The Upload File dialog box will appear. A temporary file name will be placed in the "File Name" box.
3. Under "Current CommLink Settings", select the port and address to communicate to a controller. Reference "Utilities Worksheet" in the appropriate fields. " for configuring the PC Ports.
4. Press "START". The dialog box will show "Percent Complete".
5. The Uploaded File will appear with an automatic file name containing the controller name, its local name (or alias), and the network it is on.
6. From the "File" menu, select Save or Save As and enter a file name and path in the appropriate fields.

Uploading Recipe or Data Storage

1. From the "File Menu" select **Upload...** The Upload File dialog box will appear. A temporary file name will be placed in the "File Name" box.
2. Under "Current" CommLink Settings", select the port and address to communicate to a controller. Reference "[Utilities Worksheet](#)" for configuring the PC Ports.
3. Press "START".
4. Select a file type to upload. If uploading a recipe you'll be asked to choose which recipe in the controller's memory to upload.
5. The dialog box will show "Percent Complete". When the upload is complete, the Uploaded File will appear (with a temporary file name) in the editor for that file type.
6. From the "File" menu, select Save or Save As and enter a file name and path in the appropriate fields.

Downloading a File to the Controller

Introduction



Once a control strategy—configuration file—is opened, Configuration Download transfers a configuration **FROM** the PC **TO** the controller.

The Controller may be in either RUN or PROGRAM mode (not Run-Locked)

ATTENTION: You cannot download a configuration saved as one HC900 controller model to a controller of a different model. You must first convert the configuration before doing a download. See "[Converting HC900 configurations](#)".

Procedure

1. From the File Menu select "Open" or Upload a file* from the controller.
IMPORTANT: If you intend to make a set of changes to a running configuration and wish to preserve the context of the current configuration parameters, you should perform an upload from the controller first to assure that you have the current configuration, make the incremental changes, save the modified file, and then download. This is highly recommended to avoid configuration conflicts.
2. Select the file (.cde) that is to be downloaded.
3. The selected function block diagram will appear in the Active View window. **Only the active file window can be downloaded.**
4. At this point you can make incremental changes to the file. (See "[Downloading in the RUN](#)")

- mode" first)'
- From the "File Menu" select **Download** or
click on the **Download icon** on the Main Toolbar  or
click on the **Download icon** on the *Utilities Worksheet* Toolbar  then select "Download Configuration".
 - The "Download File" dialog box will appear. Check the Port and Address information for correctness.
 - Press "START" to download the configuration to the configuration buffer.
The **download will begin** if the controller is in:PROGRAM mode or RUN mode.
The **download will be rejected** if the controller is in:RUN/LOCKED mode or OFFLINE mode.
The dialog box will show "Percent Complete".
 - After the database tables have been transferred to a configuration buffer, select one of the following commands to transfer from the buffer to the controller: Download of a safety-enabled configuration will not be allowed if there is a mismatch of I/O channel information or in case of duplicate I/O information.
 - HOT START** - the controller will use the new or updated configuration in RUN Mode.
During a Hot Start:
 - Controller memory will not be re-initialized
 - Outputs will be held at their current value.
 - Controller will stay in RUN modeThere are two possible actions with a Hot Start.
 - If the Hot Start will be completed within approximately 3 controller scan cycles, then the Hot Start will proceed automatically.
 - If the Hot Start requires longer than 3 controller scan cycles, a dialog box displays a) the estimated duration of the Hot Start and b) options to initiate or cancel the Hot Start.
 - COLD START** - the controller will transition through normal PROGRAM-TO-RUN mode transition
 - Controller memory will be re-initialized
 - Outputs will be turned off during re-start
 - Controller will return to RUN mode
 - ABORT** - the controller will disregard the new configuration and continue to use the previous configuration.
 - The dialog box status line will state "Mode Change in Progress" then "Download Successful" when completed.

Downloading in Run Mode



WARNING

While we provide application assistance personally, through our literature and the Honeywell web site, it is up to the customer to determine the suitability of the configuration in the application and the potential dangers of downloading a configuration while running.

Downloading in RUN Mode has the potential to create a hazardous situation. Changes to the configuration result in a short suspension of the control program followed by an immediate execution of the new configuration. It is the user's responsibility to ensure that configuration changes will not result in a hazardous situation.

It is the user's responsibility to assess this risk for his process. Failure to comply with these instructions could result in death or serious injury to people and/or property

damage.

Downloading in Run Mode (Hot Start) is a means to make configuration changes and download them to the controller without taking the process off-line.

It is intended for **incremental changes to a running configuration**, such as:

- Adding and Deleting Blocks
- Modifying block configuration parameters
- Adding/changing soft-wires, signals, variables
- Adding OI displays, Data Storage
- Adding Recipes, SP Profiles, SP Schedules, or Sequencers.
- Adding, deleting, or modifying I/O (DI, DO, AI, AO).

IMPORTANT: If you intend to make a set of changes to a running configuration and wish to preserve the context of the current configuration parameters you should perform an upload from the controller first to assure that you have the current configuration, make the incremental changes, and then download.

Cautions

Configuration Change Transfer

Once the HOT START button is depressed, the configuration will be updated with the new changes. Note: During the time period required to perform the Hot Start, the controller will suspend the execution of its function blocks and hold its outputs at their current value. If you select Hot Start and the Hot Start will take longer than approximately three controller scan cycles, a popup window appears:

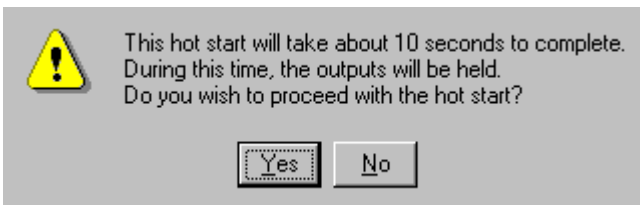

If this time period is acceptable, click Yes to begin the Hot Start. If this time period is not acceptable, press No.

Configuration Parameters

All Configuration Parameters are set to the value or state in the .cde file following a download. For example: *Tuning constants could be over written by a Download while in Run Mode.* The tuning constants are considered **part of the configuration**. If you DO NOT first upload the present configuration, you will overwrite the active parameters with the values in the configuration that are downloaded. The new download is an all or nothing proposition.

Function Block Changes

If a function block is **deleted**, Designer does not re-use the block number.

If a function block is **added**, Designer uses the highest current block number + 1.

Restrictions:

When a configuration uses the last block number (500 for C30, 2100 for C50, 5100 for C70/C70R/C75) and you try to add another block, Designer will prompt you to "de-fragment" the table and recover previously deleted blocks. **There can be NO Hot Start this case.**

Data Storage Schedule (Legacy 559/1042 OI only)

Assuming changes have NOT been made to an OI data Storage Schedule, the data storage will be interrupted only as long as it takes to transfer the configuration changes.

Downloading Controller Firmware

Background

Code download provides a mechanism to upgrade the firmware in your HC900 Process Control to a newer version without the need to replace the CPU card. This can be useful if you wish to upgrade your controller to take advantage of new features and functions as they are introduced, or in the event that a software bug requires field repair. The HC Designer upgrade files can be downloaded from website <https://www.honeywellprocess.com/en-US/explore/products/control-monitoring-and-safety-systems/modular-control-systems/hc900-control-system/Pages/hc900-controller.aspx>

Getting Started

Before you begin the download there are a few things you need to be aware of.

- Code Download can take from a couple of minutes using Ethernet to over one hour if using a Modem. Therefore, it is highly recommended that you do not start the code download procedure at a time when the likelihood of power failure is increased, such as during thunderstorms.
- The code download function is only available through the HC900 Process Control Designer program connected to the controller via the CONFIGURATION port or Ethernet port on the HC900. Use the Utilities Worksheet to do the download.
- The controller will not allow the controller firmware download to begin if the battery is bad.
- Code download will destroy the configuration database in the controller. Therefore, before code download is started, either upload the configuration file via the operator interface and save on floppy disk or other storage media, or upload and save to your PC via the software's Utilities Worksheet.

Controller Firmware Files



The firmware files for the various CPU and Scanner versions are placed in the [C:\Program Files\HC900 Firmware](#) directory when HC Designer is installed or upgraded. It is strongly recommended both controller and scanners be upgraded together.

Controller Mode

Before starting the Controller Firmware Download, switch the controller to "Program Locked" or "Program" mode. Program Locked offers more security by requiring a key to change the mode switch position. See set controller mode.

Download Procedure

Step	Action
1	Backup the controller configuration either by uploading to floppy disk on the operator interface, or uploading and saving via the Designer.
2	Make sure the controller's mode switch is in "Program" (locked) or "Run/Prog" position. If the switch is in "Run/Prog" position, go to set controller mode display and change mode to Program.
3	In Designer select the Utilities Worksheet tab.
Controller Module	

Step	Action
4	<p>From the "Controller Utilities Functions" select "Download to Controller".</p>  <p>On the sub-menu, select "Controller Firmware", then "Controller Module".</p>
5	Use the "Look in:" drop down list in the "Open" dialog box to select the drive and folder you placed the files in.
6	Select and open the file " Version.CPU " displayed in the file list box.
7	Select the "Port" and "Address" on the "Download File" dialog box.
8	Click on the "Start" button in the "Download File" dialog box. The download will start, and progress is displayed. The download itself will take a few minutes, depending on the Port type and connection.
9	<p>A "Download Succeeded" status will be displayed in the "Download File" dialog box.</p> <p>If a failure is detected, an error message will appear in the Status section of the "Download File" dialog box. See "Error Messages" for a list of possible messages and resolutions. Also see Failure Modes.</p>
Scanner Module	
10	<p>From the "Controller Utilities Functions" select "Download to Controller".</p>  <p>On the sub-menu, select "Controller Firmware", then "Scanner Module".</p>
11	Use the "Look in:" drop down list in the "Open" dialog box to select the drive and folder you placed the files in.
12	Select and open the file " Version.SCN " displayed in the file list box.
13	Select the "Port" and "Address" on the "Download File" dialog box.
14	Click on the "Start" button in the "Download File" dialog box. The download will start, and progress is displayed. The download itself will take a few minutes, depending on the Port type and connection.
15	<p>A "Download Succeeded" status will be displayed in the "Download File" dialog box.</p> <p>If a failure is detected, an error message will appear in the Status section of the "Download File" dialog box. See "Error Messages" for a list of possible messages and resolutions. Also see Failure Modes.</p>
16	Restore the configuration from the backup copy you previously made.

Failure Modes

If there is a download failure indication on the "Download File" dialog box:

- DO NOT cycle the controller power and DO NOT remove the battery.
- Check the physical connections.
- Check for power failures.
- Restart the download from the beginning.

Download Firmware Error Messages

This is a list of possible error messages that could be displayed as the result of a Download Firmware failure:

Error Message	What to do
Instrument must be in PROGRAM LOCK mode to perform this operation	Put controller in program lock mode before starting code download.
Instrument's battery missing or dead	Replace controller battery before starting code download.
Missing loader binary file	Could not open the loader file. Make sure the "loader.s19" file is in the same directory as the firmware file to be downloaded.
Could not open firmware update file	Make sure the firmware file is present in the directory selected.
Programming is not required, the downloaded version matches the code in the controller	The version in the controller matches the version that was downloaded.
The downloaded file is corrupted	The firmware file was bad. Replace the firmware file
Failed to complete file transfer	Could be caused by communication loss or controller power failure. Restart code download again.
Controller is not responding, code download failed	Could be caused by communication loss or controller power failure. Restart code download again.
Failed to put instrument into loader transfer mode	Could be caused by communication loss or controller power failure. Restart code download again.
Failed to get controller status	Could be caused by communication loss or controller power failure. Restart code download again.
Unexpected controller mode. Code download will abort. The controller will now reset	Could be caused by communication loss or controller power failure. Restart code download again.
Failed to get expansion rack status	Could be caused by communication loss or controller power failure. Restart code download again.
FLASH erase failure. Replace the controller card	The controller has a hardware problem. Replace the controller card.
FLASH programming failure. Replace the controller card	The controller has a hardware problem. Replace the controller card.
FLASH memory failure. Replace the Controller card	The controller has a hardware problem. Replace the controller card.
An incomplete code download has been detected. Do not remove controller power! Removing controller power	A previous code download was aborted or failed. Code download will proceed using the selected file.

Error Message	What to do
could result in damage to the scanner card(s)	
An incomplete code download has been detected. Code download will proceed using the selected file	A previous code download was aborted or failed. Code download will proceed using the selected file.
No scanner racks detected	Most likely cause is no expansion racks connected to the main controller. It can also be caused by a failed scanner card. If a scanner is properly connected to the controller and this message is displayed, replace the scanner card.
"Rack 1: SUCCESS, Rack 2: FAILED"	Completion report for scanner code download. There should be a SUCCESS status for each card connected to the main controller rack. A FAILED status could be caused by a communications problem between the main controller rack and the scanner racks or by a failed scanner card. Restart code download again.

File Properties

Lets you fill in the title and author of the file as well as view the file statistics (Number of Blocks, Inputs, and other items).

From the Designer Window File menu, select "Properties". Or in the File Browser Window right-click on an open configuration.

The "File Properties" dialog box will appear.

Select a tab:

General

Enter Title and Author.

Read only: Path and file name, Date created and Last Modified, Schema #, Device information (CPU type, Revision number)

Statistics

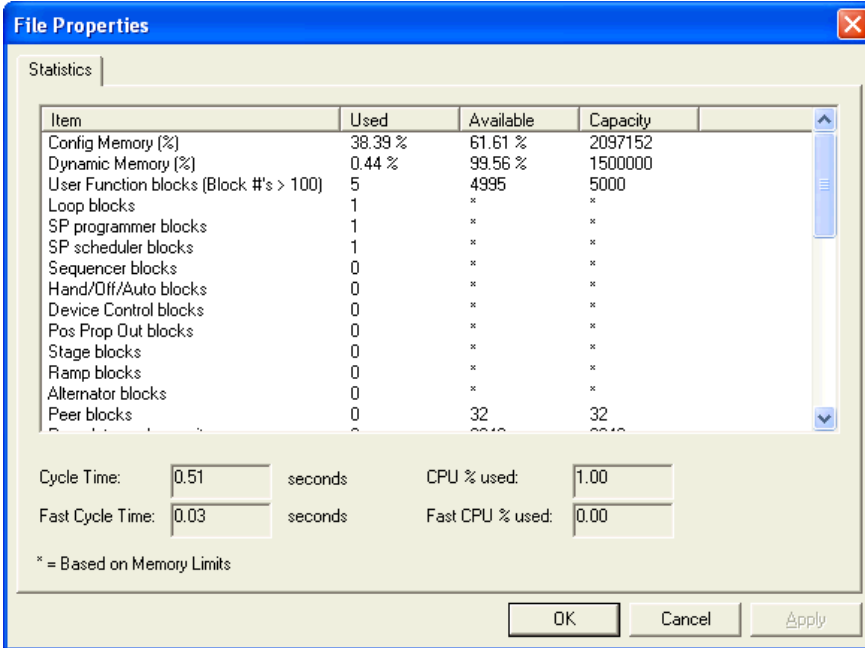

Shows usages and capacities for all items in the configuration. Asterisk * indicates there is no specific limit for this item, its limit is determined by available memory.

Cycle Time and Fast Cycle Time increase (slow down) as the following increase: CPU % Used, Fast CPU % Used, Dynamic Memory, Config Memory. Also, extensive use of Free Form Logic blocks (as opposed to equivalent gate logic) can substantially increase Fast Cycle Time.

Be aware that deleted function blocks consume memory; this memory can be made available by defragmenting.

"Read Protection" - Indicates current protection. If file is unprotected, click on "Protect File" to allow new password entry or change current password.

"Worksheet Protection" - Indicates current protection. If worksheet is unprotected, click on "Protect" to allow new password entry or change current password. Also, you can change or remove worksheet protection.

How to Add Worksheet Protection

Introduction

The HC900 Process Control Designer provides an optional configuration Worksheet protection. New files default to "No Protection". Worksheets can be protected on individual basis where all protected worksheets use the same password. A user has limited access to protected worksheets.

The HC900 Process Control Designer provides an optional configuration Worksheet protection. New files default to "No Protection". Worksheets can be protected on individual basis where all protected worksheets use the same password. A user has limited access to protected worksheets.

Protected Worksheet Type	View Worksheet?	Edit Worksheet?
Controller	YES	NO
Display	YES	NO
Function Blocks	NO	NO
Modbus Map	YES	NO

Protected Worksheets:

- can be "**unlocked**". Protection is disabled, but not removed from the file. If you save the file, the worksheet protection will be "locked" when the file is reopened.
- can have their **passwords changed**. In order to change a password, you will need to know the current password.
- Can have their **protection "removed"**. Removing the protection is permanent. If you save the file, the worksheet will not be protected when the file is reopened.

Protection Symbols

There are three symbols that could appear on the "Worksheet Protection" tab that indicate the level of protection for the file:



= No protection is in place, worksheets are 'Unlocked'



= Protection exists, and the worksheets are "Unlocked".



= Protection exists, and the worksheets are "Locked".

Protecting a Worksheet When There is No Protection

Step	Action
1	From the "File" menu, select "Properties", then select the "Worksheet Protection " tab.
2	Click on the "Change Protection" button.
3	Click on the box next to the worksheet names you want to protect, then select "DONE" button.
4	Click on the "Lock" button to setup a password.
5	Enter a password for the file in the "New Password" field (up to 14 characters).
6	Re-enter the password in the "Confirm New Password" field.
7	Click "OK".
8	In version 4.4 and greater click "Disable Master Password" if you wish to prevent others from overriding password protection by getting a master password from Honeywell. IMPORTANT NOTE: If you forget your password after Disable Master Password has been selected you will not be able to view any protected worksheets.

To Change a Password

Step	Action
1	From the "File" menu, select "Properties", then select the "Worksheet Protection " tab.
2	Click on the "Change Password" button.
3	Enter the current password in the appropriate field.
4	Enter a New Password in the appropriate field.
5	Confirm the new password in the appropriate field.
6	Click "OK".

To Temporarily Unlock a Worksheet

Step	Action
1	From the "File" menu, select "Properties", then select the "Worksheet Protection " tab.
2	Click on the "Unlock" button.
3	Enter the current password in the appropriate field.
4	Click "OK", the worksheets are unprotected NOTE: the "Controller", "Display", and "Function Block" worksheets also have a toolbar button to unlock worksheets. 

To Permanently Remove Worksheet Protection

Step	Action
1	From the "File" menu, select "Properties", then select the "Worksheet Protection " tab.
2	Click on the "Remove Protection" button.
3	Enter the current password in the appropriate field.
4	Click "OK", the worksheets are unprotected.

Protecting a Worksheet When Worksheets Protection is Active

Step	Action
1	From the "File" menu, select "Properties", then select the "Worksheet Protection " tab.
2	"Unlock" the worksheet.
3	Change protection.
4	Select worksheet names, then "DONE".
5	Select "LOCK"

File Read Protection

Protected files are password protected. You will be prompted for a password to open them.

Introduction

The HC900 Process Control Designer provides an optional configuration File Read protection. All the files default to "No Protection". Through the Properties selection on the FILE menu, you can enter a password to read protect each file. You can change the password and also remove Write protection using the same password.

Use this security feature to prevent other users from viewing your configuration. Once a file is protected and saved (or downloaded to a controller), it cannot be opened (or uploaded) unless you know the password.

Adding Read protection to a file

Step	Action
1	From the "File" menu, select "Properties", then select the "Read Protection " tab.
2	Click on the "Protect File" button.
3	Enter a password for the file in the "New Password" field (up to 14 characters).
4	Re-enter the password in the "Confirm New Password" field.
5	Click "OK".

To Change a Password

Step	Action
1	Click on the "Change Password" button.
2	Enter the current password in the appropriate field.
3	Enter a New Password in the appropriate field.
4	Confirm the new password in the appropriate field.
5	Click "OK".

To Unprotect a File

Step	Action
1	Click on the "Unprotect File" button.
2	Enter the current password in the appropriate field.
3	Click "OK", the file is unprotected

Write Protect a File

Introduction

Optional configuration File Write protection is provided. This feature makes use of the disk general file "Read Only" attribute. All the files default to "No Protection". When set to "Read Only", the file is Write Protected, which means it cannot be over written or deleted.

Select "Write Protect File" from the FILE menu.

Use the Check Box on the dialog box that appears to turn the attribute On (selected) or Off (deselected).

This page has been intentionally left blank

PC Comm Ports and Connections

How to Manage PC Comm Ports and Connections

The middle and lower portions of the Utilities Worksheet contain the PC Comm Ports and Connections functions.

Setting up your PC Comm Ports consists of the following functions:

- PC Network Port Setup for Controller Access
- PC Serial Comm Port Setup
- PC to Controller Connection Settings
- Remote Loopback test
- Remote Access
- Communications Statistics

PC Network Port Set Up For Controller Access

The software lets you setup a PC Network Port and up to 8 PC Serial/USB Comm ports for interface to a specific controller (serially via the controller's RS-232 (legacy) or RS485 configuration port or over a network via the controller's Ethernet port, accessed by its IP address). You will need an Network Interface Card (NIC) in your PC for network connection. If there is a Modem on your PC, a symbol will appear on one of the Serial comm ports buttons.

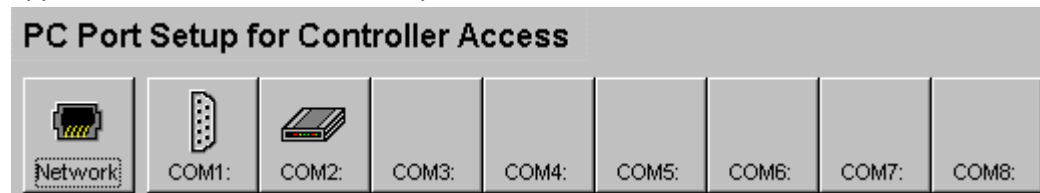

Setting Up a Network Port

1. Click on the Network Port setup button



2. The Network Port Dialog Box will Open

To ADD a Network Port:

Click on ADD and enter the properties in the Device IP Address fields.

To EDIT a Network Port:

Click a device, click on EDIT and enter the properties in the Device IP Address fields.

To Delete a Network address:

Click on a device in the Network address list, then click Delete button. The address will be deleted.

3. To do a Loopback test for a specific address click on the Loopback button.

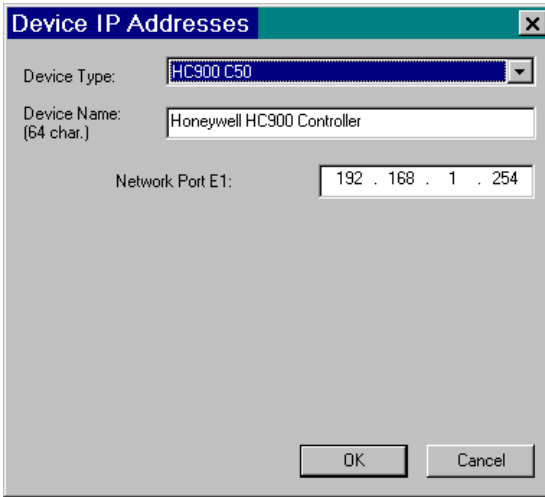
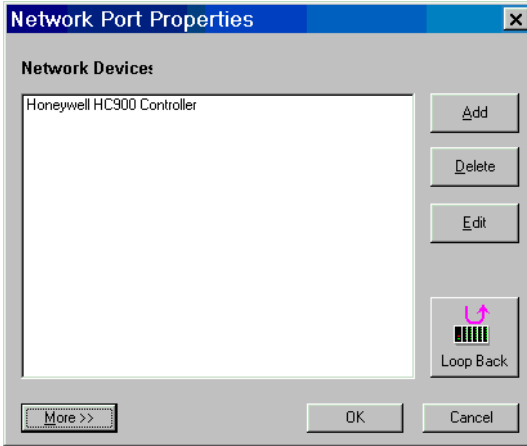

4. For **Advanced Network Setup**, click on the MORE>> button at the bottom of the "Network Port Properties" dialog box.

Number of Retries before Abort - Enter a decimal value

Retry Delay - Enter a value in milliseconds

Timeout - Enter a value in milliseconds

Note: It is not recommended that you set the values lower than those shown in the dialog box, since it may cause some communications operations to fail.

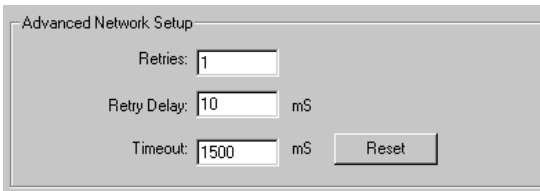

Press **Reset** button to reset these fields to their default values



PC Serial Com Port Setup

The software lets you setup a Network Port and up to 8 Serial Comm ports. If there is a Modem on your PC, a symbol will appear on one of the Serial Comm Ports buttons. See Setting up a Serial Com Port with a Modem.

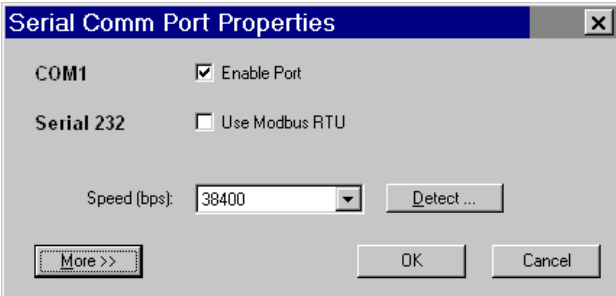
Setting Up a Serial Comm Port

<p>1. Click on the Serial Comm Port setup button. When there is no port Icon above the comm port name, the port is currently disabled. With newer PCs a USB to RS232 or USB to RS485 adapter may be used.</p>	
<p>2. The "Serial Comm Port Properties" Dialog Box will Open</p> <p>Click the 'Enable Port' box</p> <p>Manually select a Baud Rate from the "Speed" drop-down menu, or if a controller is currently connected to the ports, press the "Detect" button to detect the controller's RS232 /RS485 baud rate.</p> <p>Click OK.</p> <p>Note: The Legacy controller's serial port can be set for either RS232 or RS485 operation (by means of DIP switches on the CPU card). Version 6.0 and greater CPUs support only an RS485 serial connection. If the Detect process runs through all of the baud rates rapidly without appearing to actually check each baud rate, there may be a mismatch between the PC's serial port type and the controller's serial port type. If this behavior occurs, make sure that the DIP switches on the controller's CPU card are set correctly. The legacy controller factory settings are RS232 for Serial Port S1 and RS485 for Serial Port S2.</p>	 <p>Note: The serial comm ports are configured to default to Honeywell ELN protocol, If a user configures a serial port to use Modbus RTU (slave) protocol, the Serial 232 box may be checked for HC Designer to communicate via this protocol.</p>
<p>3. The Serial CommPort Button will now show an icon indicating that the port has been set up.</p>	

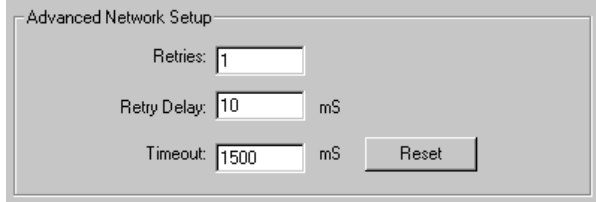
<p>4. For Advanced Network Setup, click on the MORE>> button at the bottom of the "Serial Comm Port Properties" dialog box. <i>Number of Retries before Abort</i> - Enter a decimal value <i>Retry Delay</i> - Enter a value in milliseconds <i>Timeout</i> - Enter a value in milliseconds <i>Note: It is not recommended that you set the values lower than those shown in the dialog box, since it may cause some communications operations to fail.</i> Press Reset button to reset these fields to their default values.</p>	 <p>The image shows the 'Advanced Network Setup' dialog box. It contains three input fields: 'Retries' with the value '1', 'Retry Delay' with the value '10' and 'mS' to its right, and 'Timeout' with the value '1500' and 'mS' to its right. A 'Reset' button is located to the right of the 'Timeout' field.</p>
--	---

Setting Up a Serial Comm Port with a Modem

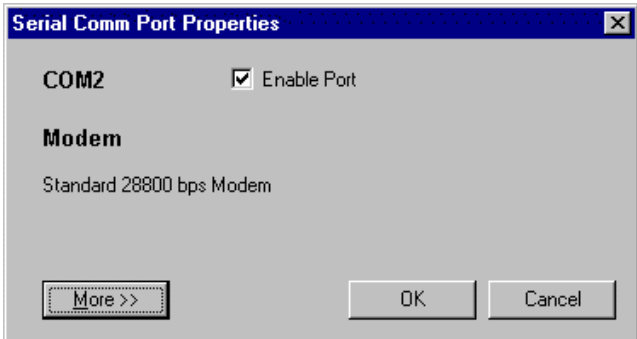
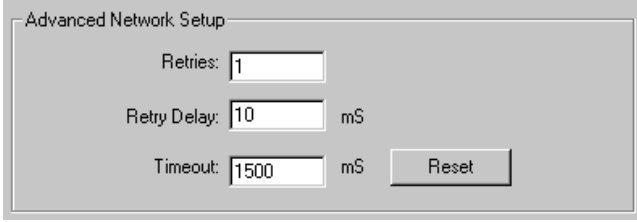
<p>1. Modems must be "Installed" in MS Windows™.</p>	
<p>2. Click on the Serial Comm Port Setup button.</p>	 <p>The image shows a small icon representing a serial port, labeled 'COM2:'. It depicts a physical port connector.</p>
<p>3. The "Serial Comm Port Properties" Dialog Box will Open Click the 'Enable Port' box There is NO Baud selection because the speed is determined by the controller's modem. Click OK.</p>	 <p>The image shows the 'Serial Comm Port Properties' dialog box. The title bar reads 'Serial Comm Port Properties'. Inside, 'COM2' is listed with a checked 'Enable Port' box. Below that, the 'Modem' section shows 'Standard 28800 bps Modem'. At the bottom, there are 'More >>', 'OK', and 'Cancel' buttons.</p>
<p>4. For Advanced Network Setup, click on the MORE>> button at the bottom of the "Serial Comm Port Properties" dialog box. <i>Number of Retries before Abort</i> - Enter a decimal value <i>Retry Delay</i> - Enter a value in milliseconds <i>Timeout</i> - Enter a value in milliseconds <i>Note: It is not recommended that you set the values lower than those shown in the dialog box, since it may cause some communications operations to fail.</i> Press Reset button to reset these fields to their default values.</p>	 <p>The image shows the 'Advanced Network Setup' dialog box, identical to the one in the first table. It has 'Retries' set to 1, 'Retry Delay' set to 10 mS, and 'Timeout' set to 1500 mS, with a 'Reset' button.</p>

5. For **Telephony Settings**, click on the MORE>> button at the bottom of the "Serial Comm Port Properties" dialog box.

Click on a radio button to select one of the following two options:

No Timeout - No timeout is performed and the application will stay connected until you Hang Up

Connection Timeout - Enter in the active field (in minutes) how long the application will leave the line open before hanging up automatically. The Modem will hang up if there is no communications activity for this amount of time.



PC to Controller Connection Settings

After setting up your PC Network and PC Serial Comm Ports:

<p>Select a Port from the drop-down menu</p>	
<p>If you selected "Network" Select the Address of the controller from the drop-down menu.</p>	
<p>You can run a loopback test</p>	
<p>You can view and reset the communications statistics</p>	

Remote Loopback Test

Remote Loopback tests the connection between the PC and the Controller.

Running the test

- Click on the Loopback icon on the Utilities Worksheet Window. . The "Remote Loopback Test" dialog box will appear.
- Click "SEND". The Status line will read:
Instrument Responded Correctly, or
Instrument did not Respond - check the connections
- Click "Close".

Remote Access

For Remote Controller Access via dial-up modem an external modem is required at the controller and is connected to the standard RS 232 configuration port.

If a modem is already installed on the PC the Designer will notify you that it exists.

Remote Access functions include on-line monitoring Live Monitor - Overview, Uploading and Downloading Configurations.

Procedure

1. Click on the Utilities tab.



2. Under PC Port Setup, click on a Comm Port.
3. The Serial Comm Port Properties dialog box opens. Click on the "Enable Port" box.



4. From the "Port" drop-down menu, select "COMx:MODEM".  will appear next to the Statistics button.
5. Click on this icon and the "Select the Number To Call" will appear.

To **Hang Up** a call, select "**Hangup Modem**" from the File Menu in the Main Menu.

A message will ask you to confirm that you want to hang up.

Select the Number to Call

Select the Number to Call Dialog Box.

To ADD a Phone Number

Type in the Phone Number, Name, and Comments in their respective fields, then click on "ADD to List". The information will appear in the Phone Number List.

To DELETE a Phone Number

Click on a name or number in the Phone Number List and click "Remove from list". The line will be deleted and all the Phone numbers and names will move up one line.

To SELECT a number to call

Click on a name or number in the Phone Number List and click "Dial".

To Hang Up a call

Select "Hangup Modem" from the File Menu in the Main Menu. A message will ask you to confirm that you want to hang up.

Communications Statistics

The "Statistics" button on the "Current PC to Controller Connections Settings" will launch the "Communications Error Summary" dialog box. The summary statistics are shown below:

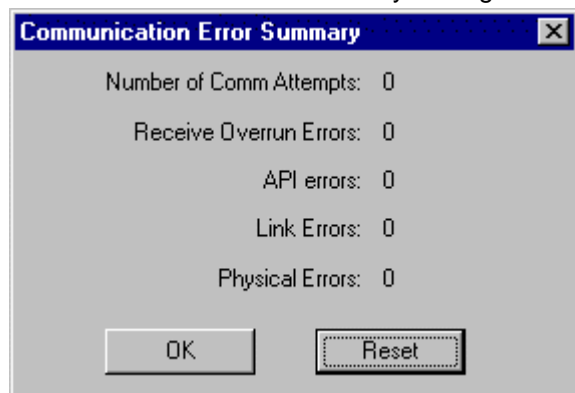

See the table below for corrective action for each communication error. Click on "Reset" to change the statistics to "0".

Error	Reason
Number of Comm Attempts	Count of messages sent down to a Controller
Receive Overrun Errors	A count of Controller response messages that were longer than expected. Make sure you have the latest version of HC Designer and that it is compatible with the Controller version. Contact Technical Support if the problem continues.
API Errors	The number of Application Errors are typically errors reported by the Controller. Common reasons for this error: Instrument responded to the wrong message. Check that there isn't more than one device with the same IP or Modbus address trying to communicate with the Controller. Controller communication port is in use by other device(s). Instrument responded with an error code. Take note of any error message dialog boxes that may popup while communicating with the Controller (e.g. While Monitoring). Attempt any corrective action based on the reported errors. Contact Technical Support if the problem continues.
Link Errors	Count of messages that could not be interpreted by HC Designer. Typically these occur when the response message contains garbled data. Check physical connections between the Controller and the PC. If you are using a modem or a serial cable, this error may be the result of "line noise".
Physical Errors	Count of hardware type errors. These typically occur when the Controller doesn't respond. Check cable and other hardware connections. If using a modem or a serial cable, verify the cable connections and baud rates of all pieces.

Worksheets Overview

What is a Worksheet?

A Worksheet is a logical partition of a configuration file. Worksheets can be further categorized by function into 6 main categories. Each category is assigned a tab in the worksheet category tab control that makes up the main Worksheet Window of a configuration. There are restrictions on the number of individual worksheets that can exist in a given category and not all categories are available to all controller types and revisions of controller firmware. Below are the different worksheet categories:

[Controller Worksheet](#)

- Displays the configuration of I/O modules
- 1 per configuration

[Operator Panel Worksheet](#)

(Also referred to as Display Worksheets)

- Display and configure Operator Interface displays
- 1 per configuration
- Not available in revision 6.0 and above

[Function Block Diagram Worksheets](#)

(This category is sub-divided into)

Process Worksheets

- 20 per configuration (for C30, C30S, C50, C50S)
- 40 per configuration (for C70, C70S, C70R, C75, C75S)

Safety Worksheets

- 20 per configuration (for C30S, C50S)
- 40 per configuration (for C70S, C75S)
- Only available for SIL-compliant controller types
- Only available in revision 6.0 and above

[Modbus Map Worksheet](#)

- Only available in revision 4.0 and higher configurations using a [Custom Modbus Address Map](#)
- 1 per configuration

[Utilities Worksheet](#)

- Provides access to a variety of maintenance functions for the controller
- 1 per configuration

Each Worksheet may have full or restricted access ([Worksheet Protection](#)).

Worksheet Category Tabs

A configuration is organized into categories shown as tabs at the bottom of the Main window:

Controller

Display

Function Blocks / Process/ Safety

Modbus Map (Rev. 4.0 configurations and higher with custom Modbus map)

An additional tab, Utilities, is provides access to a variety of useful functions that interact with the controller.



Controller Worksheet

Controller Worksheet Overview

There is one worksheet for the configuration. It displays the I/O in all configured racks.

Toolbar

The Controller Worksheet has a Toolbar to launch dialog boxes to configure:

Print Worksheet- Prints the I/O Summary as viewed on the worksheet.

Controller Identification - Enter a **controller name**. It will be displayed on the Operator Interface used for Peer Communications (16 characters).

Controller E-Mail Notification

Unlock Worksheets

I/O Summary

A summary of each addressed I/O point (as well as unassigned I/O points) in the configuration indicates:

Rack/Module/Channel

Block ID - a hot link when clicked finds the I/O block on the Function Block Diagram

Engineering Units and AI Input range





Signal Tag of primary output pin (if present) a hot link when clicked finds the signal tag on the Function Block Diagram

Signal Descriptor of primary output pin (if present)

This assignment summary is built and updated dynamically on the worksheet body. It can be printed from the toolbar Icon.

Controller Configuration Toolbar

Click on **ICON** to open a dialog box.

ICON	Function	Dialog Box Comments
	Print Worksheet	<p>Click to open the standard Print dialog box.</p> <p>Fill in appropriate fields</p> <p>Printed Output is the I/O Summary as viewed on the worksheet.</p> <p>To display each page, as it will look when printed, click Print Report Preview on the File menu.</p>
	Controller Identification	<p>Click to open the Controller Identification dialog box.</p> <p>Type in a name for your controller configuration. (same as Worksheet name)</p> <p>Also indicates controller type and revision. (read only)</p>
	E-Mail Notification	<p>Click to open the E-Mail Notification dialog box.</p> <p>Two Tabs on Dialog Box:</p> <p>General - FROM name displayed for convenience (read only) and SUBJECT information - 31 character configurable text.</p> <p>To List - enter up to 3 configurable E-Mail addresses. For each Email address check an Alarm/Event priority</p> <p>See "E-Mail Notification"</p>
	Unlock Worksheets	<p>Click to open the "<u>Unlock Worksheets</u>" dialog box. Enter a password and click "Unlock" to unlock all worksheets.</p>

E-Mail Notification



opens the **E-Mail Notification** dialog box. It lets you configure up to three E-Mail addresses per controller configuration for Alarm and Event notification.

There are two tabs on the dialog Box.

General Tab

- FROM** The **Controller name** is configured by the builder of the Configuration file [Read Only]
- SUBJECT** Enter an Event Subject (up to 31 characters)
Enter an Alarm Subject (up to 31 characters)

To List Tab -

Enter up to 3 configurable E-Mail addresses.(32 characters per addresses)

For each Email address check the Alarm/Event priorities you want the E-mail address to receive.

Events do not have multiple priorities like alarms because they are considered at a priority lower than all alarms.

Alarm priorities were set during "Alarm Group Configuration" under "Alarm Details"

- 2 = Low Priority Alarm
- 3 = Medium Priority Alarm
- 4 = High Priority Alarms
- 5 = Emergency Alarm

The priority of an event is always indicated as "1" - (see Event Configuration)

Attention: See "Set Controller Network Parameters" and follow the wizard to set up a SMTP mail server IP Address.

Examples:

Somebody@somewhere.com receives **only priority 5 Alarms**
(only the check box for "5" is checked)

Aperson@somewhere.com receives **all Alarms and Events**
(all 5 boxes are checked)

People@somewhere.com receives **only Events**
(only check box for "1" is checked)

Unlock the Worksheets

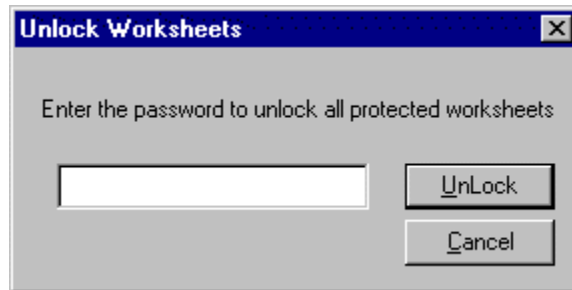

opens the "Unlock Worksheets" dialog box.

Enter the password in the field and then, press "UNLOCK".
See How to Add Worksheet Protection on page 44.

Display Worksheet

Note: This section does not apply to the 900 Control Station.

Operator Panel Worksheet Overview

The Operator Panel Worksheet has a Toolbar to launch dialog boxes to configure:

O/I Display Buttons [1 - 8] Model 1042; [1 - 5] Model 559
and Display Groups

O/I Security (Operator Interface Settings)

O/I Data Storage

Alarm Groups

Event List

Filenames

Start Up Banner Page

Help Message screens.

Unlock Worksheets

There is a Display Keys Report that indicates current O/I Button assignments:

Display Button Number

Display Position on the button





Display Format







Group Title or Tag name

This assignment summary is built and updated dynamically on the worksheet body. It can be printed from the toolbar.

Operator Panel Configuration Toolbar

Click on ICON to open the dialog box.

ICON	Function	Dialog Box Comments
	Print	Prints the OI Display Worksheet. The printed output is the list of displays on each user-assigned button as viewed on the worksheet. To display each page as it will look when printed, click "Print Preview" on the File menu.
	Display Button Configuration	Click to open Display Buttons Configuration. It lets you assign displays to the user-assigned Operator Interface keys.
	Operator Interface Settings	Click to open the " <u>Operator Interface Settings</u> " Dialog Box. It lets you edit security settings on the Operator Interface.
	Data Storage Configuration	Click to open the Data Storage Configuration dialog box. It lets you w create groups of data to be archived on the Operator Interface's storage device. Dialog box tabs are: <i>Trend, Point Log, and Alarm/Event</i>

ICON	Function	Dialog Box Comments
	Alarm Group Configuration	Click to open the Alarm Group Configuration dialog box. It lets you configure groups of alarm points in the controller to report be reported at the OI and via E-Mail. See " Configuring or Viewing Display Tag Groups ".
	Configure Event List	Click to open the Configure Event List Dialog Box. It lets you configure tags to events from the controller to be reported at the OI or via E Mail.
	Operator Interface File Names	Click to open the " O/I File Names for Disk Storage " Dialog Box. It lets you configure root names for the Operator Interface.
	Start Up Display Configuration	Click to open the Start Up Display Configuration Dialog Box. It lets you configure the Operator Interface Start Up display.
	Message Display Configuration	Click to open the " Message Display Configuration " Dialog Box. It lets you configure a set of message help displays for the Operator Interface.
	Unlock Worksheets	Click to open the " Unlock Worksheets " dialog box. Enter a password and click "Unlock" to unlock all worksheets.

Operator Interface Displays

The **Operator Interface** uses a color display to provide a variety of screen presentations for viewing control loops, setpoint programs, and other analog and digital status.

Modifying and customizing the operator interface is done using the Designer software.

With the software, data points can be identified with ASCII tag names. Once named, these data points may be accessed by the operator interface using a standard set of display formats.

Customized display access and the assignment of selected display screens to keyboard buttons may be viewed using the Operator Interface Worksheet.

All of the information for control loops and setpoint programmers will be accessed by the associated tag name while selected screens such as bar graphs, trends, and overview displays will require the user to specify the individual data points to be represented on the screen.

Display Buttons Configuration

Overview

This function lets you customize display access by assigning specific display screens to a set of assignable buttons. OI Model 1042 has 8 assignable buttons, Model 559 has 5. Each assignable button supports a sequence of up to ten screens. Screens assigned to these buttons may be Monitor screens (view data only) or Operate screens (take actions). The type of screen and the data presented on the screen is defined during configuration.

Configuration Procedure



on the Operator Panel Worksheet Toolbar opens the "Display Buttons Configuration" dialog box.



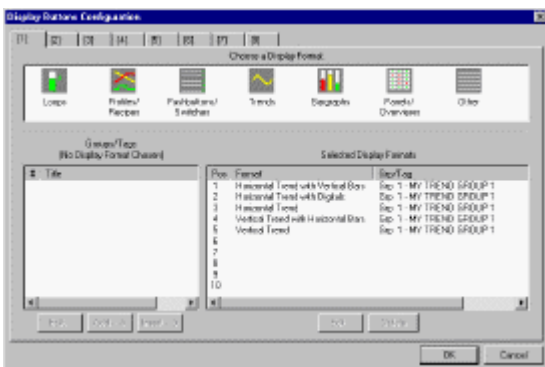



Display Worksheet Display Buttons Configuration



Select one of the tabs (one for each button) located across the top of the dialog box.

"Choose a display format" field. This will determine what will be shown in the "Groups/Tags" field located below the "Display Format" selection box.

Display Formats categories are as follows. For examples, see the *Operator Interface User Guide*.

Category	Available Display Formats
 Loops	1 Loop faceplate with trend , 1 Loop Numeric, Auto-Manual Bias, Multi-loop Faceplate
 Profiles/ Recipes	Recipe Load, Sequencer, Setpoint Programmer, Setpoint Scheduler
 Pushbuttons/ Switches	Device Control Operate, Four-Selector Switch, HOA Switch, Pushbutton
 Trends	Horizontal Trend, Horizontal Trend with Digitals, Horizontal Trend with Vertical Bars, Vertical Trend, Vertical Trend with Horizontal Bars
 Bargraphs	3 Pt Horizontal, 3 Pt Vertical, 6 Pt Horizontal, 6 Pt Vertical
 Panels/ Overviews	1 Pt Rotating Panel, Multipoint Panel, Overview, Panel - 4 Pts, Panel Meter
 Other	Alarm, Alternator Operate, Data Storage Status, Messages, Ramp Operate, Stage Operate

A list of configured Groups/Tags and their titles will appear in the "Groups/Tags" selection window on the tab. The format selection title is listed under "Groups/Tags".
Click on a Group/Tag number.

Click **ADD** - to add the selection to the "Selected Display Formats" list.

Click **INSERT** - to insert into a screen position. Other entries will shift down. Note that you must first select (click) the position in the "Selected Display Formats" list, on the right-hand side of the dialog, where you want to insert this display.

Click **DELETE** - to delete a page from a selected position in the "Selected Display Formats" list.

Click **EDIT** - to change the Tag Order or to bring up the Display Tag Group Configuration dialog box.
Note: You can also double-click on an entry in the "Groups/Tag" list or the "Selected Display Formats" list. This action produces the same result as clicking on the Edit button for the selected entry.

Each time you configure a Loop (PID, CARB, ONOFF, TPSC, or AMB), SP Programmer (SPP), SP Scheduler (SPS), Sequencer, Hands/Off/Auto Switch (HOA), Ramp, Stage, Alternator or Device Control (DC) function block, you will have assigned a unique Tag Name to the block. This selection lets you arrange tags to determine the tag order in various displays on the operator interface. The order in which they appear in this "Tag Order" dialog box can be changed to coincide with the order in which you want them to be displayed.

For other Display Groups, it allows you to go and edit the group; for example: Trend, Bar, Overview, and others.

Configuring or Viewing Display Tag Groups

Overview

The "**Display Tag Groups**" let you configure groups of tags that can be accessed by the operator interface using a standard set of display formats and a predefined menu hierarchy. These groups are configured using tabs that appear on the "Display Tag Groups Configuration" dialog box. The groups are listed below.

After you have completed all the group configurations you can select the groups to be displayed and assign them to a specific operator panel display button. Refer to (Display Button Configuration)

Configuration



on the Operator Panel Worksheet Toolbar opens the "Display Tag Group Configuration" dialog box.

Select one of the tabs (one for each group) located across the top of the dialog box.

Click on tab below to access the configuration procedure for the specific tab.



Alarms Display Tag Group

The Alarm Display Tag Group configuration tab provides a drop list of **Alarm** groups.

You can configure 20 Alarm Groups of 12 alarm points each. Each group contains a set of selected digital signal tags. An Alarm may be any Digital Signal Tag. There are up to 240 alarm points available. Each alarm point can be configured to generate an E-mail notification.

Select the **Alarm tab** then Select Display Group from the drop-down menu. Digital signals will be displayed in the "Selected Tags List" field.

You can also select "Alarms" from:

- the EDIT menu on the Main Menus
- the FBD Worksheet toolbar button

(when you **do not have** an OI and **do not** need to use Alarm Group logic in the control strategy)
- the FBD Worksheet by dropping an ALMGR block onto the configuration and either double-clicking on the block or right-clicking on the block and selecting the properties menu item on the context menu to bring up the "Alarm Group Configuration" dialog box.
(when you **do not have** an OI and **do** need to use Alarm Group logic in the control strategy)

From the "Selected Tags List" drop-down menu, select the type of tags you wish displayed in the list. The default selection is "ALL".

Enter the group title. Use any mix of numbers, letters, and spaces

Select a "Tag Name" from the "Select Tag List".

Click on **ADD**, the selected signal tag will be placed in the next available position in the "Selected Tags" field,

OR

Select a position in the "Selected Tags" field, then click on **INSERT**. The selected signal tag will be placed in the position chosen and the other signal tags will reorder as required.

Repeat the selection for up to 12 tags for each group.

Select a signal in the "Selected Tags" field and click on **ALARM DETAILS**, and enter Alarm details in the Dialog Box.

Click OK.

Note: when you edit "Alarm Group 1-20" from either the O/I Worksheet, the FBD worksheet, or the FBD Alarm Group block, you are editing the same data.

Panel Meter Display Tag Groups

This selection lets you configure groups of **Panel Meter** Displays. Each group may contain a mix of analog signal tags, digital signal tags, analog variables, and digital variables.

Select the **Panel Meter** tab then Select Display Group from the drop-down menu. Analog signal tags, digital signal tags, analog variables, and digital variables will be displayed in the "Selected Tags" field.

From the "Selected Tags List" drop-down menu, select the type of tags you wish displayed in the list. The default selection is "ALL".

Enter the group title. Use any mix of numbers, letters, and spaces.

Select a "Tag Name" from the "Select Tag List".

Click on **ADD**, the selected signal tag or variable will be placed in the next available position in the "Selected Tags" field,

OR

Select a position in the "Selected Tags" field, then click on **INSERT**. The selected signal tag will be placed in the position chosen and the other signal tags will reorder as required.

Repeat the selection for up to 12 tags for each group. Click OK.

Trend Display Tag Groups

A selection of horizontal or vertical trend format displays is available to provide a historical record of recent control performance. Trend displays may be configured with analog or digital points on each display. Trend displays allow a user selectable time period of from 0.5 to 24 hours each. Each display will retain from 1.5 to 6 screens of historical data that may be recalled from memory. Trend graph displays provide traditional value versus time plots in horizontal or vertical orientation. Each group may contain a mix of analog signal tags and digital signal tags.

Attention: If you want **trends displayed logarithmically** make sure that the first signal tag selected has the decimal place setting. (Exponential Notation). See "Signal Tags".

Select the **Trend tab** then Select Display Group from the drop-down menu. Analog signal tags and digital signal tags will be displayed in the "Selected Tags" field.

From the "Selected Tags List" drop-down menu, select the type of tags you wish displayed in the list. The default selection is "ALL".

Enter the group title. Use any mix of numbers, letters, and spaces

Select a "Tag Name" from the "Select Tag List".

Click on **ADD**, the selected signal tag will be placed in the next available position in the "Selected Tags" field,

OR

Select a position in the "Selected Tags" field, then click on **INSERT**. The selected signal tag will be placed in the position chosen and the other signal tags will reorder as required.

Enter the "Scale High" and "Scale Low" values for each signal selected.

Select a Time base for the Trend Display from the Drop down menu. (30 minutes to 24 hours)

Repeat the selection for up to 6 tags for each group.

Click OK.

Bar Display Tag Groups

This selection lets you configure 8 groups of **Bar Displays**. Bar Graph displays provide graphic representation of multiple analog or digital signal tags using horizontal or vertical orientation. Bar Graph displays are available in 3-point or 6-point vertical or horizontal format. Each group may contain a mix of analog signal tags and digital signal tags.

Select the **Bar tab** then Select Display Group from the drop-down menu. Analog signal tags and digital signal tags will be displayed in the "Selected Tags" field.

From the "Selected Tags List" drop-down menu, select the type of tags you wish displayed in the list. The default selection is "ALL".

Enter the group title. Use any mix of numbers, letters, and spaces

Select a "Tag Name" from the "Select Tag List".

Click on **ADD**, the selected signal tag will be placed in the next available position in the "Selected Tags" field,

OR

Select a position in the "Selected Tags" field, then click on **INSERT**. The selected signal tag will be placed in the position chosen and the other signal tags will reorder as required.

Enter the "Scale High" and "Scale Low" values for each signal selected. Defaults are 0 and 100.

Repeat the selection for up to 6 tags for each group.

Click OK.

Overview Display Tag Groups

This selection lets you configure groups of Overview Displays. An **Overview** display will present the current status/state for analog or digital tagged points. The display allows operator entry of values via assigned analog and digital variables.. Each group may contain a mix of analog signal tags, digital signal tags, analog variables, and digital variables for monitor only and/or operator entries. Analog entries for variables have range limits and digital variables may be turned on or off (via corresponding label).

The user may adjust analog and digital variables listed on overview displays while in operation.

Configure entry limits for analog variables. Use entry limits for analog variables. Use entry limits of 0 (low) and 1 (high) for digital limits.

Select the **Overview tab** then Select Display Group from the drop-down menu. Analog signal tags, digital signal tags, analog variables, and digital variables will be displayed in the "Selected Tags" field. From the "Selected Tags List" drop-down menu, select the type of tags you wish displayed in the list. The default selection is "ALL".

Enter the group title. Use any mix of numbers, letters, and spaces.

Select a "Tag Name" from the "Select Tag List".

Click on **ADD**, the selected signal tag or variable will be placed in the next available position in the "Selected Tags" field,

OR

Select a position in the "Selected Tags" field, then click on **INSERT**. The selected signal tag will be placed in the position chosen and the other signal tags will reorder as required.

Enter the "Min Value" and "Max Value" values for each signal selected. Defaults are -99999 and +99999

Repeat the selection for up to 12 tags for each group.

Click OK.

Single Point (Rotating) Panel Display Tag Groups

This selection lets you configure 2 groups of **Single Point (Rotating) Panel** Displays. Single Point Panel displays provide a single point alphanumeric readout that consists of the tag and current value. The display sequences through a list of up to 12 analog or digital signals or analog or digital variables. Each group may contain a mix of analog signal tags, digital signal tags, analog variables, and digital variables.

Select the **Single Point tab** then Select Display Group from the drop-down menu. Analog signal tags, digital signal tags, analog variables, and digital variables will be displayed in the "Selected Tags" field.

From the "Selected Tags List" drop-down menu, select the type of tags you wish displayed in the list. The default selection is "ALL".

Enter the group title. Use any mix of numbers, letters, and spaces.

Select a "Tag Name" from the "Select Tag List".

Click on **ADD**, the selected signal tag or variable will be placed in the next available position in the "Selected Tags" field,

OR

Select a position in the "Selected Tags" field, then click on **INSERT**. The selected signal tag will be placed in the position chosen and the other signal tags will reorder as required.

Repeat the selection for up to 12 tags for each group.

Click OK.

Multi-Point Panel Display Tag Groups

This selection lets you configure 8 groups of **Multi-Point Panel** Displays. Multi-Point Panel displays present the current value/state for up to seven Analog or Digital signal tags or analog or digital variables in the controller. Each group may contain a mix of analog signal tags, digital signal tags, analog variables, and digital variables.

Select the **Multi Point tab** then Select Display Group from the drop-down menu. Analog signal tags, digital signal tags, analog variables, and digital variables will be displayed in the "Selected Tags" field.

From the "Selected Tags List" drop-down menu, select the type of tags you wish displayed in the list. The default selection is "ALL".

Enter the group title. Use any mix of numbers, letters, and spaces.

Select a "Tag Name" from the "Select Tag List".

Click on **ADD**, the selected signal tag or variable will be placed in the next available position in the "Selected Tags" field,

OR

Select a position in the "Selected Tags" field, then click on **INSERT**. The selected signal tag will be placed in the position chosen and the other signal tags will reorder as required.

Repeat the selection for up to 7 tags for each group.

Click OK.

Alarm Details

Select a tag in the "Selected Tags" area of the Alarm Group Configuration dialog box, then click on "Alarm Details" button. The **Alarm Details** dialog box opens and enables you to enter details for the selected tag.

The block number and output number are listed across the banner. The Tag number and descriptor is listed in field below the banner.

Details include:

Alarm Priority - used for routing alarms to Email (which Email addresses get which alarms)
Each of 3 E-mail address may have any/all alarm priorities assigned to it.

2 - Low Priority Alarm

3 - Medium Priority Alarm

4 - High Priority Alarm

5 - Emergency Alarm

(select from the drop-down menu)

E Mail Notification of alarms, by priority, on a point by point basis.

(check the box to allow Email notification) The E-mail will be sent:

- if an alarm occurs on a point configured to send E-mail.

- to any/all of the 3 E-mail addresses that have the associated alarm priority assigned.

Detailed Text - appears on the Operator Interface.

(enter 2 lines of detailed text -24 characters max for each line)

Trigger Direction -

Trigger on ON state means alarm goes ON when triggered by rising edge (the discrete goes off-to-on)

Trigger on OFF state means alarm goes ON when triggered by falling edge (the discrete goes on-to-off)

(click on radio button to select)

Alarm Acknowledge - Group acknowledge

Manual Acknowledge - Can be acknowledged by operator. When a manual acknowledge alarm goes into alarm and then out of alarm without being acknowledged by the operator, it will be indicated as cleared. Use when you want the operator to be able to acknowledge the alarm or see that the alarm was acknowledged and cleared.

Auto Acknowledge -When an auto acknowledge alarm goes into alarm and then out of alarm without being acknowledged by the operator, it will show no indication it was in alarm. Alarm can still be acknowledged by the operator when it is in the alarm state. An alarm point with this attribute will never indicate "clear" status.

(click on radio button to select)

Note: an alarm will always be stored to the O/I Archive list.

Event List Configuration

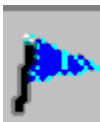

on the Operator Panel Worksheet Toolbar opens the **Configure Event List** dialog box.

You can also select "Events" from:

- the EDIT menu on the Main Menu
- the FBD Worksheet toolbar button

Up to 64 digital signals can be configured as events.

The most recent 150 events will be available for display at the Operator Interface

Events can generate Emails.

From 150 to 1500 event records can be stored on the Operator Interface archive disk.

Each event must have at least one of the following destinations:

Email, OI archive, or OI Display

You can select the events from a list of **all digital tags**.

A digital signal may be either an Event or an Alarm, but not both

Procedure

Enter a Title for the Event list.

From the drop-down menu, select the type of tags you want to display on the tag name list.

Click on each tag name you want included in the list.

Click on ADD. The selected tag or variable will be placed in the next available position in the "Selected Tags List".

Select a tag in the list then, click on "Event Details" button to enter details for the tag selected. Details include:

E Mail Notification

Store to O/I Archive List

Display on O/I

Trigger Direction for ON or OFF state

Click OK.

Event Details

The **Event Details** dialog box enables you to enter details for the tag selected when you configure events. The block number and output number are listed across the banner. The Tag name and tag descriptor is listed in field below the banner.

Events do not have multiple priorities like alarms. They are considered a lower priority than alarms.

Details include:

E Mail Notification of events on a point by point basis. (Check the box to allow Email notification) The E-mail will be sent:

- if an event occurs on a point configured to send E-mail.
- to any/all of the 3 E-mail addresses that have events assigned. **Event priorities** are always indicated as "1"

Store to OI Archive List -OI Event File on the data archive disk on an event by event basis

Display on OI - presentation on OI Status line and Event Summary display

Trigger Direction – ON – Event on rising edge (Off-to-on transition)

OFF – Event on falling edge (off-to-on transition).

(click on radio button to select)

E-Mail Notification



opens the **E-Mail Notification** dialog box. It lets you configure up to three E-Mail addresses per controller configuration for Alarm and Event notification.

There are two tabs on the dialog Box.

General Tab

- FROM** The **Controller name** is configured by the builder of the Configuration file [Read Only]
- SUBJECT** Enter an Event Subject (up to 31 characters)
Enter an Alarm Subject (up to 31 characters)

To List Tab -

Enter up to 3 configurable E-Mail addresses.(32 characters per addresses)
For each Email address check the Alarm/Event priorities you want the E-mail address to receive.
Events do not have multiple priorities like alarms because they are considered at a priority lower than all alarms.

Alarm priorities were set during "Alarm Group Configuration" under "Alarm Details"

- 2 = Low Priority Alarm
- 3 = Medium Priority Alarm
- 4 = High Priority Alarms
- 5 = Emergency Alarm

The priority of an event is always indicated as "1" - (see Event Configuration)

Attention: See "Set Controller Network Parameters" and follow the wizard to set up a SMTP mail server IP Address.

Examples:

Somebody@somewhere.com receives **only priority 5 Alarms**
(only the check box for "5" is checked)

Aperson@somewhere.com receives **all Alarms and Events**
(all 5 boxes are checked)

People@somewhere.com receives **only Events**
(only check box for "1" is checked)

Operator Interface Settings

Note: This section does not apply to the 900 Control Station.



on the Operator Panel Worksheet Toolbar opens the "**Operator Interface Settings**" Dialog Box.

Select one of the tabs:

Security

Save

Main Menu

Language

Security Tab

This lets you configure, download, and upload security settings for the operator interface. The security configuration is divided into two areas: **Operator Security** and **Engineer Security**.

Each of the security features shown in the dialog box offers a different level of security.

Item	Feature	Description
1	Enable Security	This is a master enabling switch. Click on box to enable security on any of the engineer or operator secured items that are also selected. <i>If this is not selected, no engineer or operator secured items will be secured, even if they are selected.</i>
2	Operator Security Code	Enter a 3-digit NUMERIC code that will be used to secure items 3 through 9. 0 disables Operator Security
3	Set Up Control	Click to secure access to setup items. Click off to allow unrestricted access.
4	Change between Auto and Manual Control	Click to secure loop mode AUTO/MANUAL operation Click off to allow unrestricted access
5	Change between Local and Remote Setpoint	Click to secure changing between Local and Remote Setpoints. Click off to allow unrestricted access.
6	Disk Utilities/ Data Storage	Click to secure access to disk utilities, data storage controls, and load data storage settings. Click off to allow unrestricted access.
7	Setpoint Programmer - Scheduler - Sequencer operations	Click to secure Setpoint Program/Scheduler/Sequencer operation. Click off to allow unrestricted access.
8	Recipe operations/Variable Edit	Click to secure recipe and variable edit operation. Click off to allow unrestricted access.
9	Log On/Off	Click to secure Log On/Off operation. Click off to allow unrestricted access.
10	Engineer Security Code	This is a higher level of security than the operator security code because it secures access to "off-line" functions such as calibration. Choose a 3-digit code which will be used to secure the item 11 through 13. 0 disables Engineering Security

Item	Feature	Description
11	Unit Setup	Click to secure Set Mode, Set Time and Date, Set Security, Comm Ports., Self Tests, Calibrate AI, Calibrate AO. Click off to allow unrestricted access.
12	Function Block Edit	Click to secure Edit Device Control and HOA EDIT displays. Click off to allow unrestricted access.
13	Edit Menus	Click to secure Edit Device Control and HOA operate display Edit menus. Click off to allow unrestricted access

Save tab

The Save tab is available for Rev. 2.0 or later configurations.

Prevents unauthorized saves by specifying which items can be saved to the controller's pool.

- Recipes
- Setpoint Profiles
- Schedules
- Sequences

Main Menu tab

The Main Menu tab is available for Rev. 2.0 or later configurations.

Specify which items appear on the OI main menu:

- Recipes
- SP Programmers
- SP Schedulers
- Sequencers
- Loops
- Alarms/Events/Diags
- Summary Displays
- Unit Setup
- Disk Utilities
- Data Storage
- Log Off

Language tab

Specify the language for all OI menus.

O/I File Names for Disk Storage



on the Operator Panel Worksheet Toolbar opens the **OI File Names** dialog box.

You can configure up to 25 file name roots (6-characters) for use by the operator interface in disk storage.

The Operator Interface lets you choose a name root and append it with a 2-digit number. Then a 3-character extension is automatically added to create a filename for the disk storage functions.

Please use DOS format File Names.

The first several names listed in the dialog box are defaults and can be changed.

Click on a box and enter a file name.

Start Up Display Configuration



on the Operator Panel Worksheet Toolbar opens the **Start Up Display Configuration** dialog box.

This selection lets you enter **Title Text** and **Comment Text** for your start up display. The "Start Up display" is the first screen displayed following start up and is **not associated with any display button**.

This same text is also viewed on the OI's Logoff Display.

Configuration Procedure

Enter a title on the Startup display. The title can be up to 2 lines in length but there is a maximum of 12 characters per line.

Enter a text message on the Startup display. The message can be up to 4 lines in length but there is a maximum of 24 characters per line.

Example

<p>YOUR NAME</p> <p>HERE</p> <p>SUPPORTING TEXT LINE 1 SUPPORTING TEXT LINE 2 SUPPORTING TEXT LINE 3 SUPPORTING TEXT LINE 4</p>

Message Display Configuration



on the Operator Panel Worksheet Toolbar opens the **Message Display Configuration** dialog box.

This selection lets you configure 10 pages of **Help Message Displays**.

Configuration Procedure

Select a page from the drop-down menu or navigate to the desired page using the Forward/Reverse buttons on the top of the dialog box.

Enter a title text for the display. The title can be one line in length but there is a maximum of 24 characters per line.

Enter a message text for the display. The message can be up to 11 lines in length for each page but there is a maximum of 32 characters per line.

Example

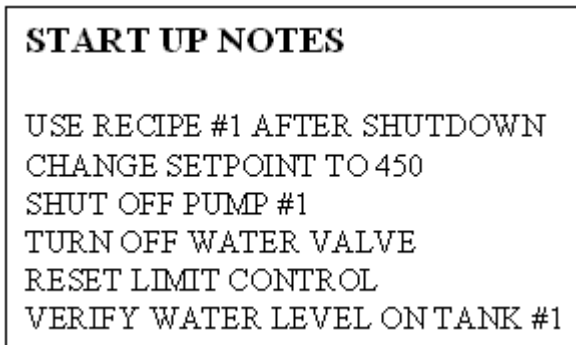

Unlock the Worksheets



opens the "Unlock Worksheets" dialog box.

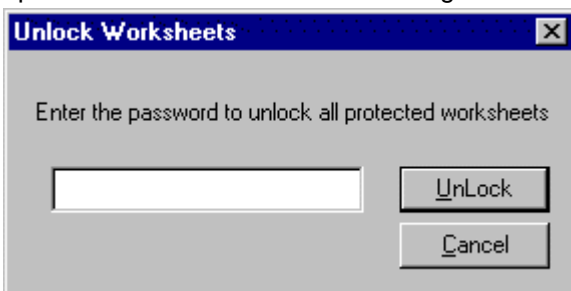

Enter the password in the field and then, press "UNLOCK".
How to add/change worksheet protection.

Data Storage

Note: This section does not apply to the 900 Control Station.

Data Storage Overview

The Data Storage feature provides background storage of process information on a storage device for analysis by an off-line computer equipped with Honeywell data analysis software.

Data stored files can not be reviewed from the operator interface. The instrument can support both continuous and discontinuous (batching) modes of the following storage types:

Trends - Two Trend groups of up to 12 points each can be stored. Floppy disk capacity for trends is inversely proportional to the number of trend points and the storage time interval (that is, the time between trend samples). For example, when storing 2 trend groups of 12 points each at a storage interval of 2 seconds, the storage device will be filled in a few hours. Conversely, when storing 1 trend group of 3 points at a storage interval of 30 minutes, the storage device could take several months to be filled.

Point Log (unit data samples) - A point log file to take a "snapshot" of process data for up to 12 points is also provided. Point log samples can be scheduled to occur at a user-specified time synchronized to the controller's Real Time Clock (RTC) or by a digital event in the controller. The maximum sample rate for point log data is 60 seconds per sample. The Point log file has a maximum capacity of between 2000 and 5000 records per file.

Alarms - Alarm recording is available to store on and off alarm actions. Alarm data includes the point tag, a 16-character point description, and the time and date of alarm occurrence. The Alarm file has a capacity of between 150 and 1500 records per file.

Events - Digital event recording is also available to store on and off transitions of digital events in the controller. Event data includes the point tag, a 16-character point description, and the time and date of event occurrence. An Event file has a capacity of between 150 and 1500 records per file.

Setpoint Programs/Schedules, instrument configurations, recipes, variables, diagnostics, and calibrations are not part of the Data Storage feature.

Data Storage Conventions

Storage Modes

Trends, Point Log, and Alarms/Events can be stored in **Continuous** or **Batch** modes. In addition, Point Log can be stored in **On Command** mode.

Mode	Description
Off	No data will be collected
Continuous	Data is sampled at the storage interval
Batch	Data is sampled at the storage interval, but also a Batch Enable Signal separates the sampled data into numbered batches. Batch #1 begins when the Batch Enable Signal turns on, and ends when the signal turns off. Batch #2 begins when the Batch Enable Signal turns on, and ends when the signal turns off, etc. No batch mode data is collected while the Batch Enable Signal is off. The Batch Enable Signal does not affect data being stored as Continuous or On Command.
On Command	Point Log data is sampled on each off-to-on transition of the Point Log Enable Signal.

Storage intervals

When data storage is enabled, samples are taken at regular intervals known as the storage intervals. These intervals can be from a few seconds to 30 minutes. Each data type has its own storage interval. For example:

Trends can be stored using one interval (like 5 seconds),
Point Log using another interval (like 10 per day), and
Alarms/Events (stored as they occur).

Or, they can **all use the same interval**. It depends on how data storage has been configured.

In **Continuous** and **Batch** modes, the storage interval determines how often data is sampled and stored:

For **trends**, data is first sampled when storage is enabled and again at equally spaced intervals thereafter. For example, if trend storage is enabled at 2:03 p.m. and the interval is 10 minutes, trend storage occurs at 2:03, 2:13, 2:23, etc. until storage is disabled.

For **Point Log**, data is first sampled after storage is enabled but not until the programmed Start Time. Data is sampled at equally spaced intervals after the Start Time. For example, suppose the Start Time is 3:00 p.m. and the storage interval is 10 minutes. If storage is enabled at 2:03 p.m., the first sample will occur at 3:00 and every 10 minutes thereafter. If storage is disabled at 3:35 and enabled at 3:42, storage will resume at 3:50. Notice that the interval is synchronized to the Start Time.

Alarm/Events are logged on occurrence with time and date (No interval)

In **On Command** mode for *Point Log*, there is no storage interval or Start Time. A single sample of Point Log data is taken when the Point Log Enable changes from off (disable) to on (enable).

How Storage is Enabled

Data collection may be started through key actions from the operator interface keyboard or from digital status signals from the controller. An "S" in the status line of the operator interface display indicates active storage. *[For detailed information refer to Data Storage Enable Conditions]*

Disk Capacity

The disk capacity (in time) is calculated and displayed once all storage initialization is complete. This eliminates the need for manual calculations and gives the operator the exact duration of the disk. All file types in the data storage feature may be configured to stop collecting data when the file is full or to continue in a circular storage mode (roll-over) where the oldest data is discarded as new data is collected. When roll-over is **not** selected, a disk full warning indication is provided in the status line of the display. The configurator, as required, may change the percent full limit. A storage buffer in the operator interface allows changing the disk media without the loss of process data.

Calculation for Data Storage Capacity

$$\text{Trend Capacity (In Hours)} = \frac{\text{Disk factor} * (R1)}{F1 + (F2 * (R1/R2))}$$

Where:

R1 and R2 are the storage rates (in seconds) for Trend 1 and Trend 2, respectively.

F1 and F2 are the point factors associated with the number of points per trend file.

Disk Factors:

398	Trends files only active
394	Trends files + Alarms and Events
347	Trend files, + alarms and Events + Point Log Files

Number of points in trend

1	2	3	4	5	6	7	8	9	10	11	12
14.00	20.16	26.53	33.60	38.77	45.82	50.40	56.00	63.00	72.00	84.00	84.00

Point Factor (F1 and F2)

File Extensions

The following File Extensions are used for the HC900 Controller's Data Storage output files:

LNT for **Trend** Files

LNP for **Point Log** Files

LNA for **Alarm** Files

LNE for **Event** Files

Data Storage Enable Conditions

How storage is enabled

Data Storage Enable/disable is an Operator Interface function. If a schedule is developed in the software, all storage is automatically enabled.

Enable controls

The figure below shows the controls that must be enabled for each storage mode and data type. The left side shows the three data types and their possible storage modes (only one storage mode is in effect for any data type). The arrows show the conditions required for that storage to take place.

For example, trend batch storage requires:

the Trend Storage Control to be on (enabled at configuration – if any signal is selected for storage i.e. Signal Enable = NONE),

the Batch Command Control to be on (enabled at configuration), and

the Data Storage Control to be enabled (enabled at Operator Interface).

Notice that the Batch Command Control applies only to batch storage mode.

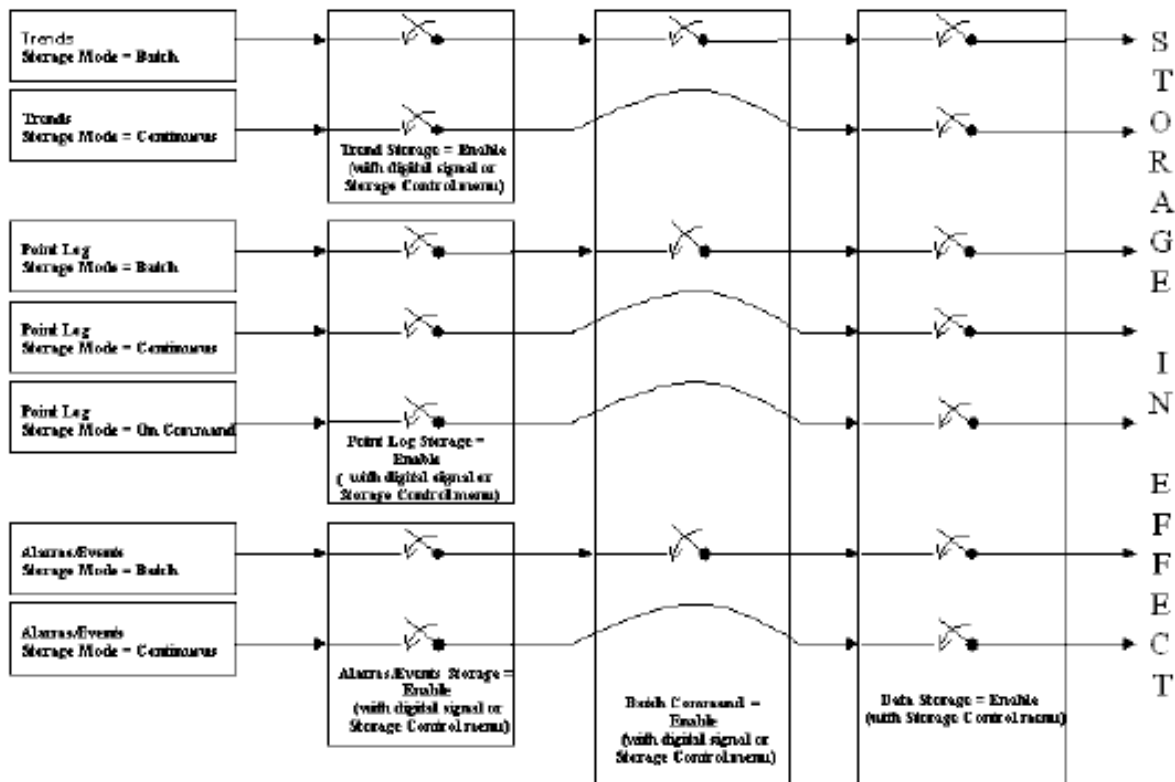

Three Levels of Enabling

There are three levels of Data Storage Enable:

Data Storage Disable Signal (Operator Interface) – See Note 1.

Data Type Enable Signals

Batch Command Enable Signal

Note 1. *Since any storage schedules loaded into the system automatically enables storage, the operator interface can disable storage.*

Data Type Enable Signals

This level of control is the Data Type Enable Signal. Each data type (trends, point log, and alarms/events) has its own Enable Signal that can either be configured as a digital signal on the Designer, or if not configured as a digital signal (NONE selected on Designer Data Storage Configuration), it will appear on the Storage Control menu on the operator interface

For example, if the Trend Enable Signal is *configured as a digital signal in the Designer Data Storage Configuration*, it will **not** appear on the Storage Control menu on the operator interface. This is done to avoid having two conflicting sources for the enable signal.

When a *digital signal is not used*, the Trend enable signal is set to enable when the configuration is loaded. The Trends can then be disabled from the Operator Interface.

The Enable Signal has two functions for Point Log storage.

In Continuous and Batch modes, it enables Point Log storage to begin at the Start Time and at every storage interval thereafter.

In On Command mode, when it changes from off (disable) to on (enable), it causes a single sample of Point Log data to be stored at that moment. (*See Point Log Storage Enable Conditions*)

Batch Command Enable Signal

This level of control is the Batch Command. It is a single control signal that starts and stops storage for all data types configured for batch storage. **It does not affect Continuous or On Command storage.**

If the Batch Signal is *configured as a digital signal* in the Designer Data Storage Configuration, it will **not** appear on the Storage Control menu on the Operator Interface. This is done to avoid having two conflicting sources for the signal.

When a *digital signal is not used* and Batch storage has been selected, the Batch command signal is set to Stop. Batches can be started from the Operator Interface.

Storage Enable Conditions

Trend Storage Enable Conditions

The figure below shows examples of Trend Storage Enable Conditions.

Notice that **Continuous Trend** storage occurs unless **Trend Disable** or **Data Storage Disable** is selected.

For **Batch Trend** storage, notice that Trend enable/disable, Data Storage enable/disable must be set to enable and Batch command must be Start.

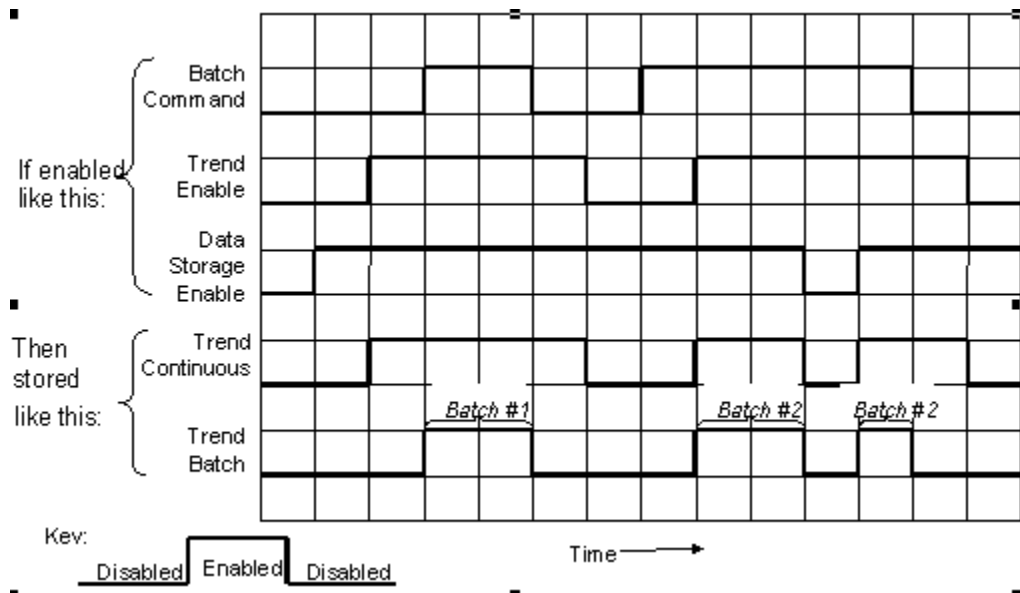

Point Log Storage Enable Conditions

The figure below shows examples of Point Log Storage Enable conditions.

Notice that it occurs unless **Point Log Disable** or **Data Storage Disable** is selected.

For **Batch Point Log** storage, notice that *all three enables must be on*.

The figure shows that storage does not actually occur until the Start Time occurs, and then at every Storage Interval thereafter.

For **On Command Point Log** storage, notice the samples are taken the instant Point Log Enable is enabled but not at intervals.

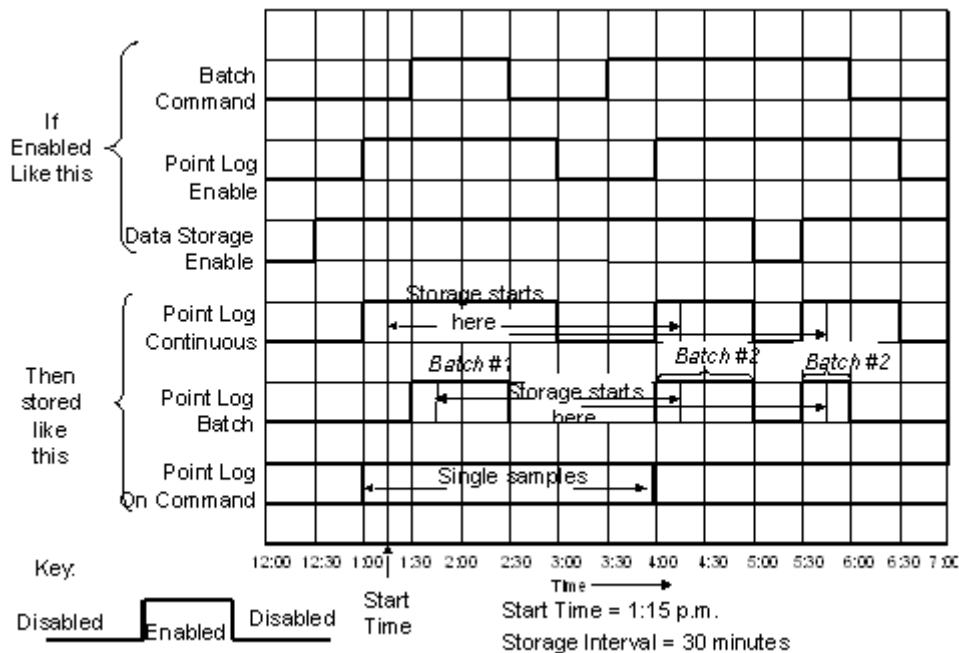

Alarm/Event Storage Enable Conditions

The figure below shows examples of Alarm/Event Enable conditions.

Notice that **Continuous Alarm/Event** storage occurs unless **Alarm/Event Disable** and **Data Storage Disable** is selected.

For **Batch Alarm/Event** storage, *all three enables must be on*.

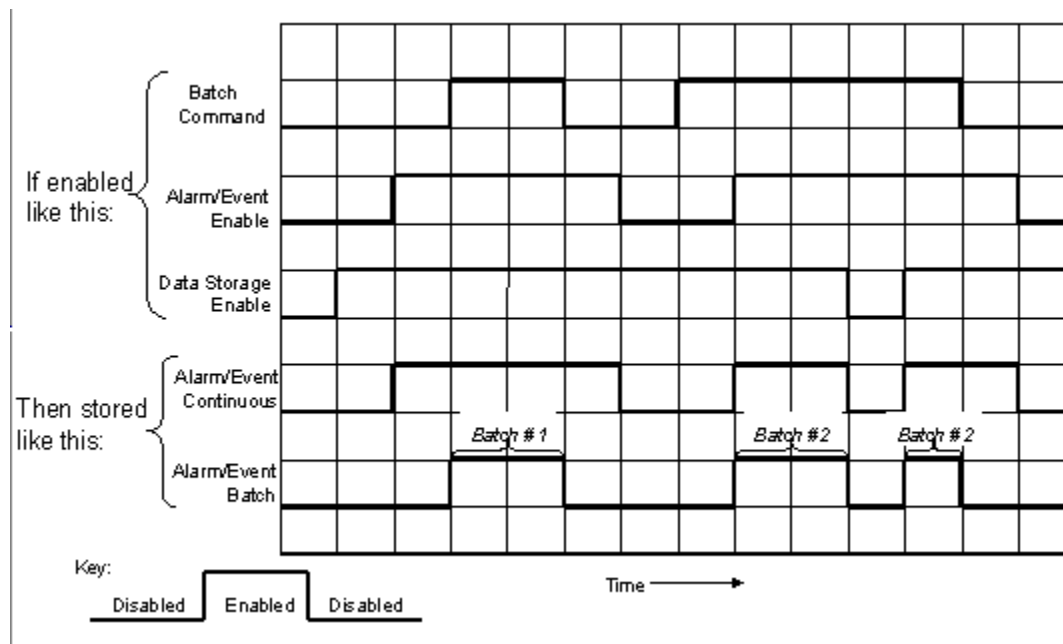

1: Although Alarm Storage is active during the specified time periods, Alarm records will only be saved on active transitions of the alarm status. If no alarm occurs during the active period, the data for that period will be blank.

Data Storage Configuration Access



on the Operator Panel Worksheet Toolbar opens the **Data Storage Configuration** dialog box.

This facility allows you to configure groups of data that will be stored to the Operator interface's data storage device. This process history can be a valuable source of information to analyze process operations quality and upsets.

The groups are configured in Designer and downloaded as part of the configuration.

You can also create a new data storage file (.dss) separate from the configuration. On the File menu, select New, Data Storage.

Select a tab at the top of the dialog box to access a specific Data Storage Configuration dialog box.

Click on a button below for specific Data Storage Configuration Instructions.

[Trend Storage](#) [Point Log Storage](#)

Create/Edit Data Storage File

Creates/edits a data storage file (.DSS). File can be downloaded to the controller.

Step/Item	Action/Description
Select File, Open.	Lets you choose a .DSS file to edit. After selecting file the Data Storage Editor appears.
OR	
Select File, New.	"Choose a new file type" box appears.
Select Data Storage tab.	Data Storage button appears.
Select Data Storage.	The Data Storage Editor appears.
THEN	
Select a Reference Configuration.	A data storage file must have a configuration to give it context. Select an open configuration from the pull-down list. If none available, select Open Configuration to open one. The configuration will open. Click back to Data Storage Editor and select the reference configuration.
Trend	Trend setup.
Point Log	Point Log setup.
Alarm/Event	Alarms/Events setup.
Pre-initialize Disk	Prepares zip disk for data storage. Select this to avoid the long initialization time on the operator interface.
Print	Prints the data storage settings.
Save	Saves the data storage file as .DSS file.
Download	Downloads data storage file to the controller.

Trend Storage Configuration

Trend storage will provide the following:

Number of Files:	2 maximum
Points per Trend:	12 maximum, Analog or Digital
Storage Modes:	Off, Batch, Continuous
Storage Interval:	2, 5, 10, 20,30,40, 50 seconds 1, 2, 5, 10, 20, 30 minutes
External Control:	Digital Tagged Signal – Start/Stop of both Trends

Configuration Procedure

Select the "TREND" tab on the "Data Storage Configuration" dialog box.

Active Field	Description
Batch Enable Signal	<p>This signal starts and stops storage for Trends configured for "Batch" storage. It does not affect "Continuous" storage selection.</p> <p>From the pull-down menu, select:</p> <p>NONE – Batch is started/stopped only through the operator interface's Data Storage Control Menu (defaults to Stop on configuration download)</p> <p>ANY DIGITAL TAG – Batch is started/stopped only through the on/off state of the selected Digital Signal. It will not appear on the operator interface's data Storage Control Menu</p> <p><i>For detailed information concerning Data Storage Enable, refer to "Data Storage Enable Conditions"</i></p>
Group	Use the pull-down menu and select a Trend Group for configuration.
Title	<p>Enter a Group Title. There is a maximum of 24 characters</p> <p><i>(Note: This is not displayed on the Operator Interface. It only serves as a reminder for the user.)</i></p>
File name	Enter a File Name. There is a maximum of 8 Alpha Numeric characters. (DOS File Name restrictions)
Tag List	<p>From the Tag List drop-down menu, select the type of signals you want the tag list to display.</p> <p>Click on a Tag Name and click ADD>>.</p> <p>The tag name will be added to the "Selected Tags" list.</p>
Selected Tag List	<p>Scaling Signals</p> <p>Scale each tag selected for High and Low values for the Trend Display. Click on the "Scale High" and "Scale Low" fields and enter the value.</p> <p>To delete a signal tag, click on a tag and click Delete.</p>
Storage Intervals	<p>Storage Interval</p> <p>From the Storage Interval drop-down menu, select a storage interval of from 2 seconds to 30 minutes.</p> <p>When Data Storage is enabled, samples will be taken at the interval selected here.</p> <p><i>Refer to Storage Intervals in Storage Conventions</i></p>
Data Type Enable Signals	<p>This enable signal turns storage on and off for trends.</p> <p>From the pull-down menu, select:</p>

Active Field	Description
	<p>NONE – Trend Storage Enable is started/stopped only through the operator interface's Data Storage Control Menu (defaults to Enable on configuration download), or,</p> <p>ANY DIGITAL TAG – Trend Storage is started/stopped only through the on/off state of the selected Digital Signal. It will not appear on the operator interface's data Storage Control Menu</p> <p><i>For detailed information concerning Trend Storage Enable, refer to "Trend Storage Enable Conditions".</i></p>
Storage Mode	<p>From the pull-down menu, select a Storage Mode.</p> <p>Refer to "Data Storage Conventions" for mode definitions.</p>
Rollover	<p>Click this box to allow data storage to continue collecting data in a circular storage mode where the oldest data is discarded as new data is collected.</p> <p>Clear this box to allow data storage to stop collecting data when the file is full. You can configure a Warning Level for Disk Full %.</p>
Warning Level	<p>If you do not select rollover, enter a percent in the appropriate box.</p>

Point Log Storage Configuration

Point Log storage will provide the following:

Number of Files:	One
Points per File:	12 maximum, Analog or Digital
Storage Modes:	Off, Batch, Continuous, On Command
Storage Interval: (all relative to start time)	1 to 59 minutes, one minute increments 1 to 23 hours, one hour increments 1 to 30 days, one day increments Once month, same day of each month
External Control:	Digital Tagged signal - start/stop storage to file - On Demand sampling

Configuration Procedure

Select the "**POINT LOG**" tab on the "Data Storage Configuration" dialog box.

Active Field	Description
Batch Enable Signal	<p>This signal starts and stops storage for Point Logs configured for "Batch" storage. It does not affect "Continuous" or "On Command" storage selections.</p> <p>From the pull-down menu, select:</p> <p>NONE – Batch is started/stopped only through the operator interface's Data Storage Control Menu (defaults to Stop on configuration download)</p> <p>ANY DIGITAL TAG – Batch is started/stopped only through the on/off state of the selected Digital Signal. It will not appear on the operator interface's data Storage Control Menu</p> <p><i>For detailed information concerning Data Storage Enable, refer to "Data Storage Enable Conditions".</i></p>
File name	<p>Enter a File Name. There is a maximum of 8 Alpha Numeric characters. (DOS File Name</p>

Data Storage
Alarm/Event Storage Configuration

Active Field	Description
	restrictions)
File Record Limit	Enter a File Record Limit number of between 2000 and 5000.
Tag List	<p>From the Tag List drop-down menu, select the type of signals you want the tag list to display.</p> <p>Click on a Tag Name and click ADD>>.</p> <p>The tag name will be added to the "Selected Tags" list.</p>
Selected Tag List	<p>Scaling Signals</p> <p>Scale each tag selected for High and Low values for the Point Log Display. Click on the "Scale High" and "Scale Low" fields and enter the value.</p> <p>To delete a signal tag, click on a tag and click Delete.</p>
Data Type Enable Signals	<p>This enable signal turns storage on and off for Point Logs.</p> <p>From the pull-down menu, select:</p> <p>NONE – Point Log Storage Enable is started/stopped only through the operator interface's Data Storage Control Menu (defaults to Enable on configuration download), or,</p> <p>ANY DIGITAL TAG – Point Log Storage is started/stopped only through the on/off state of the selected Digital Signal. It will not appear on the operator interface's data Storage Control Menu</p> <p><i>For detailed information concerning Trend Storage Enable, refer to "Point Log Storage Enable Conditions".</i></p>
Storage Mode	<p>From the pull-down menu, select a Storage Mode.</p> <p>Refer to "Data Storage Conventions" for mode definitions.</p>
Storage Interval	<p>NOTE: <i>For On Command storage mode, there is no storage interval or start time. (They are not used.)</i></p> <p>Click on "Change". The "Storage Interval" dialog box will appear.</p> <p>Click on the radio button for Minutes, Hours, or Days and select a storage interval from the Edit box.</p> <p>Or, click on the radio button for "Once a Month".</p> <p>Click OK</p> <p><i>Refer to Storage Intervals in Storage Conventions</i></p>
Start Time	<p>NOTE: <i>For On Command storage mode, there is no storage interval or start time. (They are not used.)</i></p> <p>Click on "Change". The "Change Time" dialog box will appear.</p> <p>In the Edit box in each field, select a start time.</p> <p>Click OK.</p> <p><i>Refer to Storage Intervals in Storage Conventions</i></p>
Rollover	<p>Click this box to allow data storage to continue collecting data in a circular storage mode where the oldest data is discarded as new data is collected.</p> <p>Clear this box to allow data storage to stop collecting data when the file is full. You can configure a Warning Level for Disk Full %.</p>
Warning Level	If you do not select rollover , enter a percent in the appropriate box.

Alarm/Event Storage Configuration

Alarm/Event storage will provide the following:

Number of Files:	One each
Records per File:	150 to 1500 records per file
Data Types:	All Alarms – Time/Date, On/Off All Events – Time/Date, On/Off
Storage Modes:	Off, Batch, Continuous
External Control:	Digital Tagged Signal – Start/Stop storage to file

Configuration Procedure

Select the "**Alarm/Event**" tab on the "Data Storage Configuration" dialog box.

Active Field	Description
Batch Enable Signal	<p>This signal starts and stops storage for Alarm/Events configured for "Batch" storage. It does not affect "Continuous" storage selections.</p> <p>From the pull-down menu, select:</p> <p>NONE – Batch is started/stopped only through the operator interface's Data Storage Control Menu (defaults to Stop on configuration download)</p> <p>ANY DIGITAL TAG – Batch is started/stopped only through the on/off state of the selected Digital Signal. It will not appear on the operator interface's data Storage Control Menu</p> <p><i>For detailed information concerning Data Storage Enable, refer to "Data Storage Enable Conditions"</i></p>
Alarm File Name	Enter a File Name. There is a maximum of 8 Alpha Numeric characters. (DOS File Name restrictions)
Alarm File Record Limit	Enter an Alarm File Record Limit number of from 150 to 1500.
Event File Name	Enter a File Name. There is a maximum of 8 characters
Event File Record Limit	Enter an Event File Record Limit number of from 150 to 1500.
Data Type Enable Signal	<p>This enable signal turns storage on and off for Alarm Events.</p> <p>From the pull-down menu, select:</p> <p>NONE – Alarm/Event Storage Enable is started/stopped only through the operator interface's Data Storage Control Menu (defaults to Enable on configuration download), or,</p> <p>ANY DIGITAL TAG – Alarm/Event Storage is started/stopped only through the on/off state of the selected Digital Signal. It will not appear on the operator interface's data Storage Control Menu</p> <p><i>For detailed information concerning Trend Storage Enable, to "Alarm/Event Storage Enable Conditions"</i></p>
Storage Mode	<p>From the pull-down menu, select a Storage Mode.</p> <p>Refer to "Data Storage Conventions" for mode definitions.</p>
Rollover	<p>Click this box to allow data storage to continue collecting data in a circular storage mode where the oldest data is discarded as new data is collected.</p> <p>Clear this box to allow data storage to stop collecting data when the file is full. You can configure a Warning Level for Disk Full %.</p>
Warning Level	If you do not select rollover , enter a percent in the appropriate box.

Function Block Diagram (FBD) Worksheet

FB Worksheet Overview

Function Block Diagram Worksheets let you build your [control strategy](#) graphically right on the [User Interface](#). It provides a full complement of SAMA-style symbols that we call [Function Blocks](#) that can be "[softwired](#)" to each other. It also includes [signal tag](#) generation capability for resident control data that can be linked to displays and other software programs.

The Function Block Diagram Worksheet has a [Toolbar](#) to launch dialog boxes to configure:

Worksheet Properties - Enter a configuration name and description in the appropriate fields.

[Alarm Group Configuration](#)

[Event List Configuration](#)

[Block Order](#)

The toolbar also contains icons for Cut, Copy, and Paste; Zoom Level, and an Icon to toggle a grid on and off on the worksheet.

The Function Blocks are listed in the appropriate Worksheet Toolbox (Function Block Menu Tree).

You can Drag and Drop the function blocks from the menu onto the worksheet and softwire them to create a control and/or safety strategy. See [FB Diagram Rules](#).

Note that with Controller Rev 6.0 and higher, there is now the concept of "Safety" function-block-diagram worksheets (vs. the regular "Process" function-block-diagram worksheets) for controllers that support it. The Safety worksheets allow definition of "Safety-enabled" configurations to run on SIL-compliant controller models. Within Safety worksheets, certain restrictions at both configuration and run-time are enforced to ensure safety compliance is achieved.

The "Process" worksheet is the same as the "FBD" worksheet as they were called prior to Rev 6.0.

Note that a "Safety" function-block-diagram worksheet may be simply called "Safety worksheet", and a "Process" function-block-diagram worksheet may be simply called "Process worksheet", for purposes of brevity. Also, a function block that is placed on a Safety worksheet may be simply called a "Safety block".

When a new configuration is created, the Safety worksheet tab will only appear if the controller model and revision selected is a SIL-compliant model/revision.

There are:









- | | |
|--------------------|--|
| Process Worksheets | <ul style="list-style-type: none">• 20 per configuration (for C30, C30S, C50, C50S)• 40 per configuration (for C70, C70S, C70R, C75, C75S) |
| Safety Worksheets | <ul style="list-style-type: none">• 20 per configuration (for C30S, C50S)• 40 per configuration (for C70S, C75S)• Only available for SIL-compliant controller types• Only available in revision 6.0 and above |







- Up to 20/40 worksheets per configuration depending on controller model A total of up to 400 Function Block Pages (20 x 20) for non-SIL controllers C30, C50
- A total of up to 800 Function Block Pages (40 x 20) for non-SIL controllers C70, C70R, C75
- A total of up to 800 Function Block Pages (20 x 20 x 2) for SIL controllers C30S, C50S
- A total of up to 1600 Function Block Pages (40 x 20 x 2) for SIL controllers C70S, C75S

There is extended use of [Right Mouse Click](#).

FBD Configuration Toolbar

Click on ICON to open the dialog box.

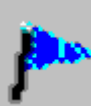
ICON	Function	Dialog Box Comments
	Print Worksheet	Click to print the active worksheet. It opens the "Print" dialog box for printing.
	Append Process Worksheet / Append Safety Worksheet	Adds a new Process or Safety block diagram. If selected, a new worksheet will be created and a new sub-tab for it will appear at the bottom of the diagram window. The new diagram reference will be placed in the File Browser. Click on the diagram name in the File Browser to edit the name.
	Delete Process Worksheet / Delete Safety Worksheet	Click to delete the selected Process / Safety Worksheet highlighted on the File Browser. This will delete all the items in the worksheet.
	Reorder Process Worksheets / Reorder Safety Worksheets	Opens the Worksheet order dialog box. Allows you to change the order of the worksheets as they appear at the bottom of the Worksheet area. Click on worksheet name and use the increment-decrement buttons at the top of the dialog box to change the worksheet order.
	FBD Worksheet Properties	Type in a title and description of your FBD Worksheet. The title will appear in the File Browser and on the associated FB Worksheets tab at the bottom of the diagram.
	Cut	Moves the currently selected FBD diagram items from the current Function Block diagram and places them on the clipboard. Indicated by a red dotted line. Upon pasting the items, all links to them (e.g., display references, Modbus address, recipes) are preserved as if they were moved, they are not deleted and pasted as a new copy.
	Copy	Copies the currently selected FBD diagram items from the current Function Block diagram and places it on the clipboard. Indicated by a blue dotted line.
	Paste	Places the contents of the clipboard containing FBD diagram items onto the Function Block Diagram at the location determined by the blinking insertion point caret. This command is unavailable if the clipboard is empty. Cut and pasted items maintain their links (e.g., display references, Modbus addresses, recipes), they are not deleted and pasted as a new copy. If you paste a cut function block and soft wires to the same or different worksheet in the same configuration, the soft wires will be dangling (unconnected) and you are asked to specify how you want to resolve dangling soft wires.

ICON	Function	Dialog Box Comments
	Find Item	Allows you find an Item on the FBD worksheet. Opens the "Find Item" dialog box.
	Zoom Out	You can "zoom out" to see more of the page at a reduced size. Zoom levels of 50%, 75%, 100%, 125%, and 150%.
	Zoom In	You can "zoom in" to return items to normal size. Zoom levels of 50%, 75%, 100%, 125%, and 150%.
	Grid	Lets you place a grid in the FBD Diagram. This can aid in the placement of items on the diagram.
	Alarms	Click to open the "Alarms Group Configuration" Dialog Box. It lets you configure alarm points. See " Alarm Group Configuration "
	Events	Click to open the "Configure Event List" Dialog Box. It lets you configure events in the controller. See " Event List Configuration "
	Block Tag Order	Click to show drop down menu. Lets you change the execution order of the function blocks. Select Execution Order, Fast Logic Order, or Tag Order.
	Unlock Worksheets	Click to open the " Unlock Worksheets " dialog box. Enter a password and click "Unlock" to unlock all worksheets.

How to Add a New FBD Worksheet

Right click on the FBD Worksheet name on the Browser. Select "Append New Worksheet", or Select the "New FBD Worksheet" icon on the Function Block Diagram Toolbar (far left), or From the Edit menu on the Main Drop-down menus, select "Append New Worksheet".

A new worksheet will appear at the bottom of the Function Block Diagram list in the browser and a blank worksheet will be placed on the Designer.

Right click on the new Worksheet name in the browser or double-click on the worksheet's tab then, select Properties and set the new worksheet properties.

For each worksheet added, a tab will appear at the bottom of the Function Block Worksheet area with the name of the worksheet that was set in "Worksheet Properties" on it. Use the scroll bar for access to a specific worksheet tab.

How to Navigate Between FBD Worksheets

Use the Worksheet Tabs

For each worksheet added, a tab will appear at the bottom of the Function Block Worksheet area with the name of the worksheet that was set in "Worksheet Properties" on it. If necessary, use the scroll bar to access other worksheet tabs. Click on the tab to select the associated Worksheet.

Use the File Browser

The File Browser, located on the top left side of the Worksheet, is a movable window listing opened files.

It allows you to move quickly between files and worksheets.

To select a particular Worksheet, double-click the Function Block Worksheet name.

Use the Connection Traceback

Access the Trace Window from the Main Menu Toolbar



Or, from the View Menu on the main menu.

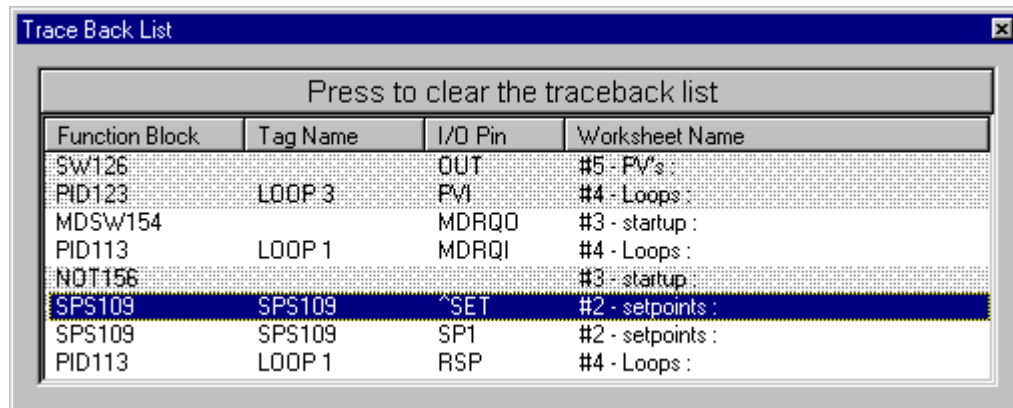

The image shows a screenshot of a software window titled "Trace Back List". At the top of the window, there is a button that says "Press to clear the traceback list". Below this is a table with four columns: "Function Block", "Tag Name", "I/O Pin", and "Worksheet Name". The table contains several rows of data, with the row for "SPS109" and "SPS109" with I/O Pin "SET" highlighted in blue.

Function Block	Tag Name	I/O Pin	Worksheet Name
SW126		OUT	#5 - FV's :
PID123	LOOP 3	PVI	#4 - Loops :
MDSW154		MDRQD	#3 - startup :
PID113	LOOP 1	MDRQI	#4 - Loops :
NOT156			#3 - startup :
SPS109	SPS109	SET	#2 - setpoints :
SPS109	SPS109	SP1	#2 - setpoints :
PID113	LOOP 1	RSP	#4 - Loops :

The Trace Window provides a list of all blocks/pins you have traced and lists :

- Block ID
- Tag Name
- I/O Pin Name
- Worksheet name

The last trace is on the top of the list.

Selecting a function block from the list will activate the associated function block worksheet.

Use the "Find Item" feature

From the "Edit" Menu on the main menu select "Find". It lets you search for an item on the FBD Worksheet.

Select the item type from the "Show" drop down menu on the "Find Item" dialog box.

Select an item from the "Item" drop-down menu. Click on the Worksheet in the "Find Results" field and the associated worksheet will be selected and the Tag, Variable, or Function Block will be highlighted on the worksheet.

Keyboard Navigation

Press	To
LEFT ARROW	Scroll worksheet to the left
RIGHT ARROW	Scroll worksheet to the right
UP ARROW	Scroll worksheet up
DOWN ARROW	Scroll worksheet down
END	Go to the end of last page
HOME	Go to the beginning of first page
PAGE DOWN	Go to the next worksheet page
PAGE UP	Go to the previous worksheet page
CTRL+LEFT ARROW	Go to the end of last page
CTRL+RIGHT ARROW	Go to the beginning of first page
CTRL+UP ARROW	Go to the top of the page
CTRL+DOWN ARROW	Go to the bottom of the page
CTRL+PAGE DOWN	Go to the next worksheet tab
CTRL+PAGE UP	Go to the previous worksheet tab

Other keyboard functions

If necessary, you can use the standard keystroke conventions to move around.

ALT *used together with the underlined letter in text labeling an object lets you select that object.*

TAB *select next field or object in dialog boxes and configuration templates*

SHIFT+TAB *select previous field or object in dialog boxes and configuration templates*

UP ARROW *previous choice in the field*

DOWN ARROW *next choice in the field*

ALT+DOWN ARROW *opens a drop-down list box*

Traceback Window

Overview

This feature helps you find problems with soft-wire and signal connections between Function Blocks.

For Example:

If you are testing a configuration that you've built and want to know why a Digital Output is ON when it should be OFF, you can search for the source of the Input Signal.

Traceback is useful for finding the analog or digital source signal.

Trace Window

Access the Trace Window from the Main Menu Toolbar



Or, from the View Menu on the main menu.

Function Block	Tag Name	I/O Pin	Worksheet Name
SW126		OUT	#5 - FV's :
PID123	LOOP 3	PVI	#4 - Loops :
MDSW154		MDRQD	#3 - startup :
PID113	LOOP 1	MDRQI	#4 - Loops :
NOT156			#3 - startup :
SPS109	SPS109	^SET	#2 - setpoints :
SPS109	SPS109	SP1	#2 - setpoints :
PID113	LOOP 1	RSP	#4 - Loops :

It is a dockable, sizeable window.

The Trace Window provides a list of all blocks/pins you have traced and lists :

- Block ID
- Tag Name
- I/O Pin Name
- Worksheet name

Trace Window Update

Each time you perform a Trace, the window will update with a new pair of block/pins.

The **first item** is the **signal source**, the **second item** is the **signal destination**.

Select any of the rows in the Traceback window to recall the diagram to display the selected block.

The last trace is on the top of the list.

Right Mouse Click Procedure to Trace Signals

Select a Function Block of interest.

Right Mouse click on any INPUT pin.

Select "TRACE". Traceback will "find" the source of the connection you selected and refresh the FBD view with that block visible (Highlighted) - even if the other side of the connection is on a **different** worksheet.

The Output pin of the block (the signal source) will be displayed in RED.

From that block, repeat the traceback to another block and another block, etc.

Use the Traceback list to view your Traceback history.

You can clear the Trace List by pressing the bar at the top of the window.

Resolve Dangling Soft Wires

When you cut a function block(s) and any connected soft wires, after you paste the selection onto the same or different worksheet *in the same configuration*, the pasted soft wires are left dangling (unconnected). To resolve these dangling soft wires a dialog box appears with the following choices.

Delete dangling soft wires. Select this to delete the soft wires from the pasted function block(s). The soft wire connections prior to the cut will be broken.

Split dangling soft wires using signal tags. Select this to restore the pre-cut connections using automatically created signal tags. The function blocks will again be connected not with soft wires but with signal tags.

Split dangling soft wires using page connectors (available in configuration revisions 2.x or higher). Select this to restore the pre-cut connections using automatically created page connectors. The function blocks will again be connected not with soft wires but with page connectors.

The last two choices are selectable only if sufficient quantities of signal tags or page connectors remain.

ATTENTION: The automatically created signal tags or page connectors can sometimes overlap or hide the original connectors so check behind them, don't assume the previous connectors were replaced.

Examples

Before the cut:

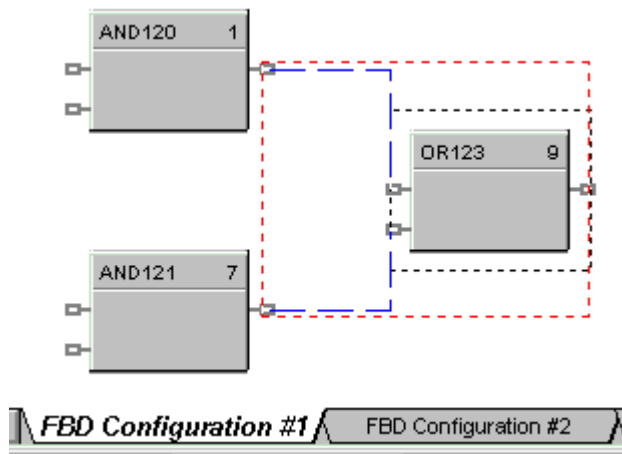

After pasting on a different worksheet and **Delete dangling soft wires**:

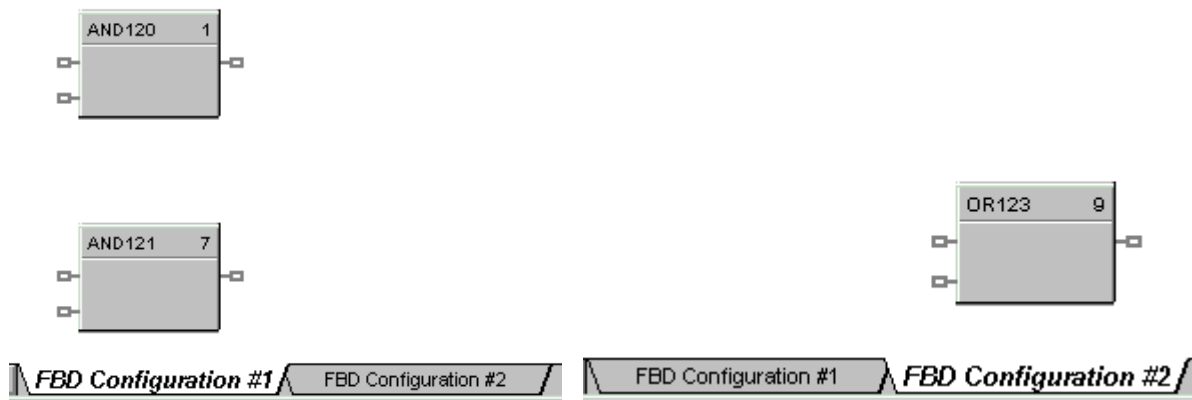

After pasting on a different worksheet and **Split dangling soft wires using signal tags:**

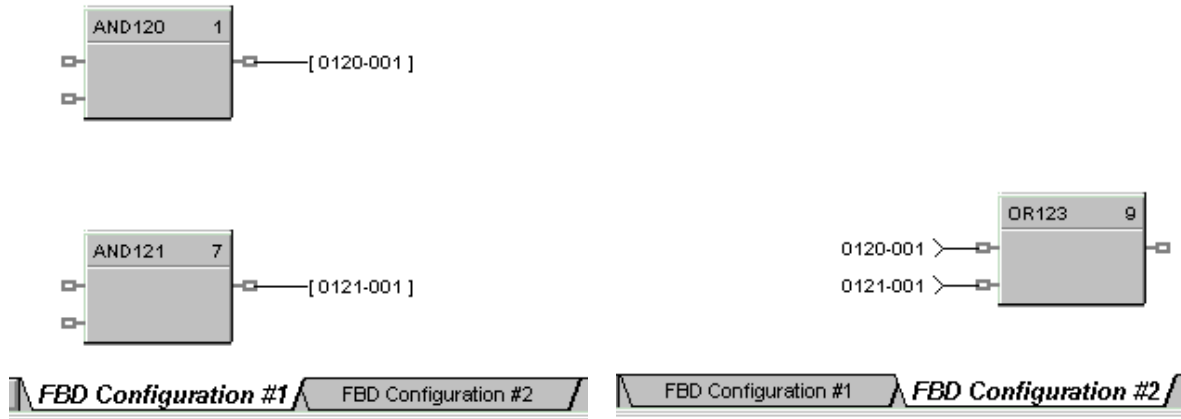

After pasting on a different worksheet and **Split dangling soft wires using page connectors:**

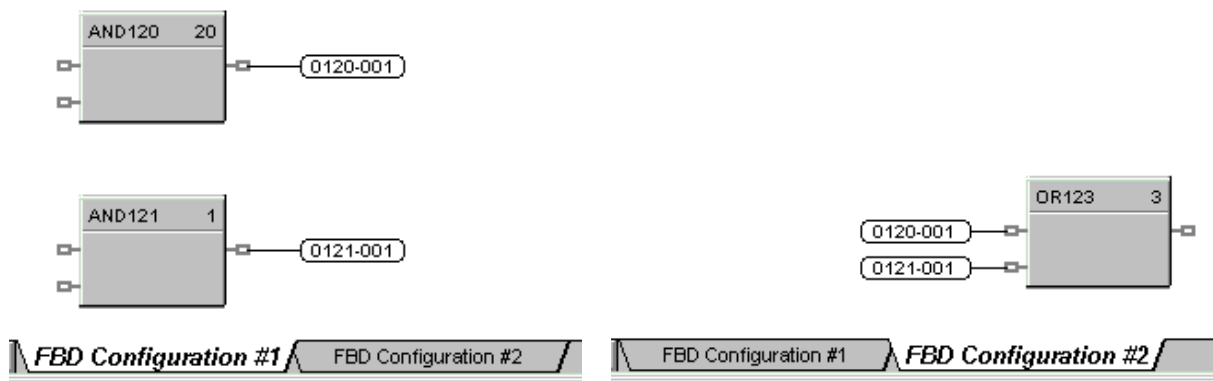

How to Find an Item on the FBD Worksheet



On the FBD worksheet lets you find an item and all places it is used (such as a signal tag used multiple times).

Access

From Edit menu or by right clicking an item on the FBD worksheet. Opens the "Find Item" dialog box.

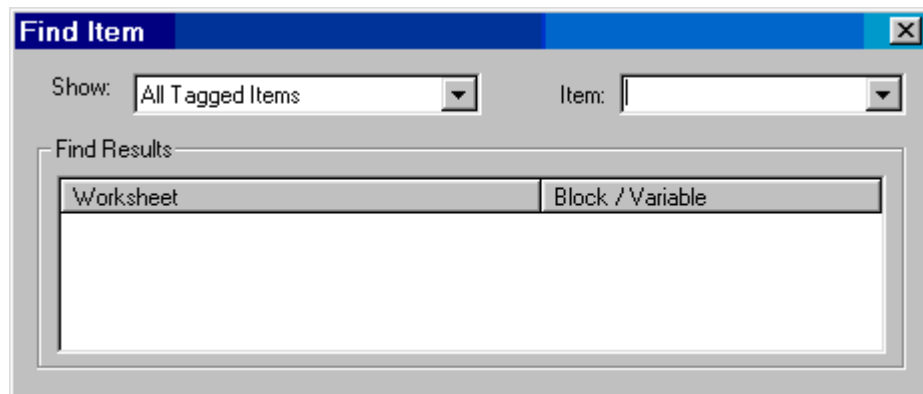

From the "Show" drop-down menu, choose an item type

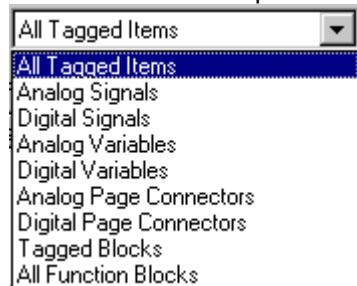

From the "Item" drop-down menu, choose an item. If you already right clicked on an item in the FBD worksheet it will be displayed here.

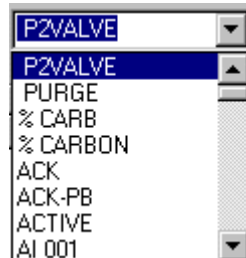

The Find Results" field will indicate the Worksheet where the item is located. Click on the Worksheet name and you will jump to the item on the worksheet.

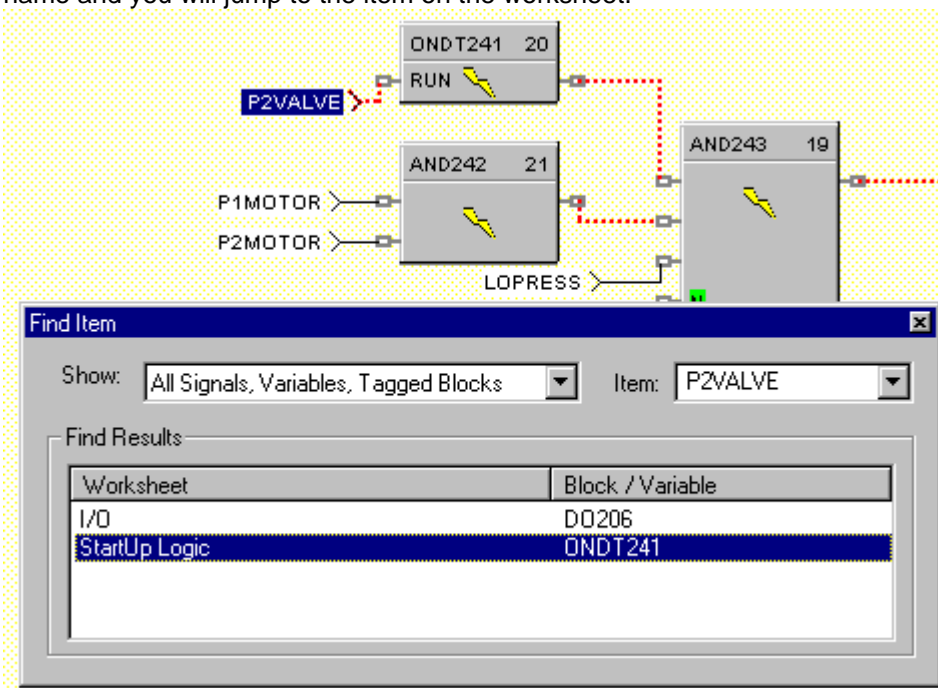

Double click on an item on the worksheet to open the "properties" dialog box. The Tag or Variable Number or Function Block name will appear on the dialog box banner.

How to Change a FBD's Worksheet Properties

Right click on the new Worksheet name in the browser and select "Properties", or

Double click on the worksheet tab, or

Select the "Properties" icon on the Function Block Diagram Toolbar (3rd from left), or

From the Edit menu on the Main Drop-down menus, select " Worksheet Properties".

Enter a Title (*worksheet name will appear on the File Browser and worksheet tabs*) and Description (*enhance the Worksheet name with descriptive text*) in the appropriate fields of the dialog box. The descriptive name appears on the FBD Report Printouts. Reference "Print Report"

How to Change the Worksheet Order

The Worksheet Order dialog box lists the FBD worksheets as they appear on the tabs at the bottom of the Function Block Worksheet area.

In the dialog box, click on the Worksheet name that you want to reorder

Change the worksheet order using the Increment/decrement buttons at the top right of the worksheet order dialog box

The tabs will be reordered at the bottom of the worksheet area.

How to Delete a FBD Worksheet

Right click on the new Worksheet name in the browser and select "Delete Worksheet", or

Select the "Delete" icon on the Function Block Diagram Toolbar (2nd from left), or

From the Edit menu on the Main Drop-down menus, select " Delete Worksheet". The selected worksheet will be deleted.

How to Add Worksheet Protection

Introduction

The HC900 Process Control Designer provides an optional configuration Worksheet protection. New files default to "No Protection". Worksheets can be protected on individual basis where all protected worksheets use the same password. A user has limited access to protected worksheets.

Protected Worksheet Type	View Worksheet?	Edit Worksheet?
Controller	YES	NO
Display	YES	NO
Function Blocks	NO	NO
Modbus Map	YES	NO

Protected Worksheets:

- can be "**unlocked**". Protection is disabled, but not removed from the file. If you save the file, the worksheet protection will be "locked" when the file is reopened.
- can have their **passwords changed**. In order to change a password, you will need to know the current password.
- Can have their **protection "removed"**. Removing the protection is permanent. If you save the file, the worksheet will not be protected when the file is reopened.

Protection Symbols

There are three symbols that could appear on the "Worksheet Protection" tab that indicate the level of protection for the file:



= No protection is in place, worksheets are "Unlocked"



= Protection exists, and the worksheets are "Unlocked".



= Protection exists, and the worksheets are "Locked".

Protecting a Worksheet When There is No Protection

Step	Action
1	From the "File" menu, select "Properties", then select the "Worksheet Protection" tab.
2	Click on the "Change Protection" button.
3	Click on the box next to the worksheet names you want to protect, then select "DONE" button.
4	Click on the "Lock" button to setup a password.
5	Enter a password for the file in the "New Password" field (up to 14 characters).
6	Re-enter the password in the "Confirm New Password" field.
7	Click "OK".
8	In version 4.4 and greater click "Disable Master Password" if you wish to prevent others from overriding password protection by getting a master password from Honeywell. IMPORTANT NOTE: If you forget your password after Disable Master Password has been selected you will not be able to view any protected worksheets.

To Change a Password

Step	Action
1	From the "File" menu, select "Properties", then select the "Worksheet Protection " tab.
2	Click on the "Change Password" button.
3	Enter the current password in the appropriate field.
4	Enter a New Password in the appropriate field.
5	Confirm the new password in the appropriate field.
6	Click "OK".

To Temporarily Unlock a Worksheet

Step	Action
1	From the "File" menu, select "Properties", then select the "Worksheet Protection " tab.
2	Click on the "Unlock" button.
3	Enter the current password in the appropriate field.
4	Click "OK", the worksheets are unprotected NOTE: the "Controller", "Display", and "Function Block" worksheets also have a toolbar button to unlock worksheets. 

To Permanently Remove Worksheet Protection

Step	Action
1	From the "File" menu, select "Properties", then select the "Worksheet Protection " tab.
2	Click on the "Remove Protection" button.
3	Enter the current password in the appropriate field.
4	Click "OK", the worksheets are unprotected.

Protecting a Worksheet When Worksheets Protection is Active

Step	Action
1	From the "File" menu, select "Properties", then select the "Worksheet Protection " tab.
2	"Unlock" the worksheet.
3	Change protection.
4	Select worksheet names, then "DONE".
5	Select "LOCK"

Alarm Group Configuration



opens the **Alarm Group Configuration** dialog box.

You can also select "Alarms" from:

- the [EDIT menu](#) on the Main Menu
- the FBD Worksheet by dropping an ALMGP block onto the configuration - when you **do not have** an O/I and **do** need to use Alarm Group logic in the control strategy)

The Alarm Display Tag Group configuration tab provides a drop list of **Alarm** groups. You can configure:

- For controller Rev 4.0 or higher: 30 Alarm Groups of 12 alarm points each for a total of 360 alarm points in the controller.
- For lower revisions: 20 Alarm Groups of 12 alarm points each for a total of 240 alarm points.

Each group contains a set of selected digital signal tags. An Alarm may be any Digital Signal Tag.

All alarms are displayed at the OI.

Each alarm point can be configured to generate an [E-mail notification](#).

Procedure

1. Select a Display Group from the drop-down menu. Digital signals will be displayed in the "Selected Tags" field.
2. From the "Selected Tags List" drop-down menu, select the type of tags you wish displayed in the list. The default selection is "ALL".
3. (For Safety-enabled configurations only) From the "Safety Filter" drop-down menu, select the type of tags you wish displayed in the list. The default selection is "ALL".
4. Enter the group title. Use any mix of numbers, letters, and spaces
5. Select a tag then click on **ADD**, the selected signal tag will be placed in the next available position in the "Selected Tags" field,
OR
Select a position in the "Selected Tags" field, then click on **INSERT**. The selected signal tag will be placed in the position chosen and the other signal tags will reorder as required.
6. Repeat the selection for up to 12 tags for each group.
7. Select a signal in the "Selected Tags" field and click on **ALARM DETAILS**, and [enter Alarm details](#) in the Dialog Box.
8. Click OK.

Alarm Details

Select a tag in the "Selected Tags" area of the Alarm Group Configuration dialog box, then click on "Alarm Details" button. The **Alarm Details** dialog box opens and enables you to enter details for the selected tag.

The block number and output number are listed across the banner. The Tag number and descriptor is listed in field below the banner.

Details include:

Alarm Priority - used for routing alarms to Email (which Email addresses get which alarms)

Each of 3 E-mail address may have any/all alarm priorities assigned to it.

2 - Low Priority Alarm

3 - Medium Priority Alarm

4 - High Priority Alarm

5 - Emergency Alarm

(select from the drop-down menu)

E Mail Notification of alarms, by priority, on a point by point basis.

(check the box to allow Email notification) The E-mail will be sent:

- if an alarm occurs on a point configured to send E-mail.

- to any/all of the 3 E-mail addresses that have the associated alarm priority assigned.

Detailed Text - appears on the Operator Interface.

(enter 2 lines of detailed text -24 characters max for each line)

Trigger Direction -

Trigger on ON state means alarm goes ON when triggered by rising edge (the discrete goes off-to-on)

Trigger on OFF state means alarm goes ON when triggered by falling edge (the discrete goes on-to-off)

(click on radio button to select)

Alarm Acknowledge - Group acknowledge

Manual Acknowledge - Can be acknowledged by operator. When a manual acknowledge alarm goes into alarm and then out of alarm without being acknowledged by the operator, it will be indicated as cleared. Use when you want the operator to be able to acknowledge the alarm or see that the alarm was acknowledged and cleared.

Auto Acknowledge -When an auto acknowledge alarm goes into alarm and then out of alarm without being acknowledged by the operator, it will show no indication it was in alarm. Alarm can still be acknowledged by the operator when it is in the alarm state. An alarm point with this attribute will never indicate "clear" status.

(click on radio button to select)

Note: an alarm will always be stored to the O/I Archive list.

Event List Configuration

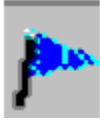

on the Operator Panel Worksheet Toolbar opens the **Configure Event List** dialog box.

You can also select "Events" from:

- the [EDIT menu](#) on the Main Menu
- the [FBD Worksheet toolbar](#) button

- Up to 64 digital signals can be configured as events.
- The most recent 150 events will be available for display at the Operator Interface
- Events can generate Emails.
- From 150 to 1500 event records can be stored on the Operator Interface archive disk.
- Each event must have at least one of the following destinations:
 - Email, OI archive, or OI Display
- You can select the events from a list of **all digital tags**.
- A digital signal may be either an Event or an Alarm, but not both

Procedure

1. Enter a Title for the Event list in the "Title" editbox.
2. From the drop-down menu below the "Title" editbox, select the type of tags you want to display on the tag name list.
3. (For Safety-enabled configurations only) From the "Safety Filter" drop-down menu, select the type of tags you want to display on the tag name list.
4. Click on each tag name you want included in the list.
5. Click on ADD. The selected tag or variable will be placed in the next available position in the "Selected Tags List".
6. Select a tag in the list then, click on "[Event Details](#)" button to enter details for the tag selected.
Details include:
 - E Mail Notification*
 - Store to O/I Archive List*
 - Display on O/I*
 - Trigger Direction for ON or OFF state*
7. Click OK.

Execution Order

Execution Order is the order in which function blocks are executed in the control strategy. There is a separate execution order for each of the two available scan rates, [Normal Scan](#) and [Fast Scan](#). Each function block within a given scan rate is assigned a relative Block Execution Order number. Blocks are executed in increasing order, with blocks having lower execution order numbers being executed before those with higher execution order numbers. The Block Execution Order of each block is shown as a number in the top right-hand corner of the block's graphic on the function block diagram, as shown below.

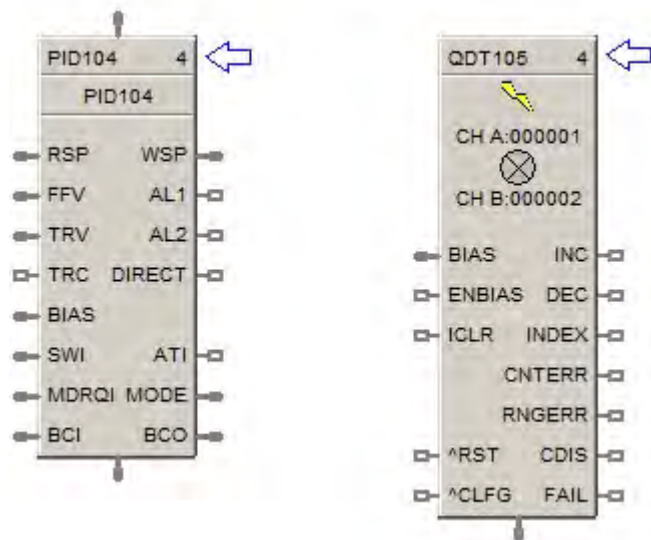

In the diagram above, both function blocks have an execution order of 4. This is allowed because the PID104 block is executing at the [Normal Scan](#) rate, whereas the QDT105 block is executing at the [Fast Scan](#) rate, as indicated by the **yellow lightning bolt** on the QDT134 graphic.

It should be noted that the Block Execution Order is independent of the [Block Number](#). Both the Block Number and the Block Execution Order are assigned in the sequence in which they are programmed, however, the Block Number must be unique throughout all function blocks, while the Block Execution Order only needs to be unique throughout the function blocks in the same scan rate. The system remembers the last programmed Block Execution Order for both scan rates independently.

You can override the execution order determined by the system during programming. Block Numbers, on the other hand, can not be reassigned. There are two ways to change the execution order; by assigning a specific Block Execution Order number to a single function block, or by changing the relative execution order of multiple function blocks.

Assigning a Block Execution Order

To change the Block Execution Order of a specific function block on a function block diagram, double-click in the top portion of the block's graphic where the Block Number and Block Execution Order are displayed (circled in the diagram below).



This action will display the Change Block Execution Order dialog on top of the function block graphic as shown below.

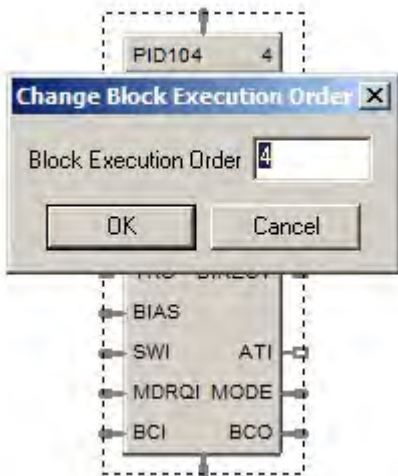

The block's execution order can be changed by entering a new number in the entry box and clicking on the OK button. You can increase or decrease the block's execution order to any value from 1 to 2100. If you enter a value outside this range an error message will be displayed.

When you click on the OK button the Block Execution Order of the selected function block is set to the new value. Any other function blocks in the same execution rate that have current execution orders equal to or greater than the new value will have their execution order incremented to retain uniqueness. For example, if the Block Execution Order of the PID104 block shown in the diagrams above is changed to 5, the Block Execution Order of the AI107 block will be incremented to 6, but the Block Execution Order of the DI108 block will remain at 5, as shown below.





When you change a block's execution order in this way, the previous execution order number is not reassigned to another block, but rather it is dropped from the list of used execution order numbers. This can leave gaps in the assigned execution order numbers. A similar situation occurs when a function block is deleted from a diagram. This does not create a problem for block execution, as it is the relative value of the execution order numbers that matter, not the absolute value. It does mean, however, that you can change the Block Execution Order number of a block without actually changing its true execution order if no other function block is assigned a number between the previous and new values.

Changing Relative Execution Order of Multiple Blocks



The relative execution order of one or more function blocks executing at either the [Normal Scan](#) or [Fast Scan](#) rates may be changed through the Function Block Execution Order dialog. This method has an advantage over the method described above, even for single function blocks, because the absolute values of the assigned execution order numbers does not have to be known and the function blocks from all function block diagrams are displayed together.

The Function Block Execution Order dialog can be accessed in a number of ways as described below. Note that while the same dialog is used to change the execution order of either the [Normal Scan](#) or [Fast Scan](#) function blocks, there are separate selection methods to pre-populate the dialog's list with the correct function blocks.



Edit Menu

1. Select **Edit** from the main application menu.
2. Select **Block and Tag Order** and activate sub-menu.
3. Select either  **Block Execution Order...** or  **Fast Block Execution Order...** to launch the Function Block Execution Order dialog.



Function Block Diagram Worksheet Toolbar

1. Click on the  icon in the Worksheet Toolbar displayed above any Function Block Diagram Worksheet to activate the drop-down menu.
2. Select either  **Block Execution Order...** or  **Fast Block Execution Order...** to launch the Function Block Execution Order dialog.





Function Block Diagram Worksheet Context Menu

1. Right-click in any whitespace area of any Function Block Diagram Worksheet to activate the context menu.
2. Select either  **Block Execution Order...** or  **Fast Block Execution Order...** to launch the Function Block Execution Order dialog.

Function Block Graphic Context Menu

1. Right-click within the body portion of any normal scan or fast scan function block graphic (not the pins) to activate the context menu.
2. Select either  **Block Execution Order...** or  **Fast Block Execution Order...**, depending on which function block was selected in step 1, to launch the Function Block Execution Order dialog.

Worksheet Toolbox Context Menu

1. Click on the Process or Safety tab of the Worksheet Toolbox to display a browser view of the function blocks currently in use.
2. Expand the folder of one of the function block types used in the configuration.
3. Right-click on either the icon or name of any  normal scan or  fast scan rate function block to activate the context menu.
4. Select either  **Block Execution Order...** or  **Fast Block Execution Order...**, depending on which function block was selected in step 3, to launch the Function Block Execution Order dialog.

When one of the above actions is taken, the Function Block Execution Order dialog box is displayed, as shown below. The list box will be populated with all of the function blocks executing at the selected execution rate, [Normal Scan](#) or [Fast Scan](#). If there are more function blocks that can be displayed in the list box a vertical scrollbar will be displayed.

- If the dialog is accessed through the function block graphic context menu or the worksheet toolbox context menu, the corresponding function block will be selected in the dialog.
- If the dialog is accessed through the edit menu, worksheet toolbar or the worksheet context menu and a function block has been selected on an active function block diagram worksheet, that function block will be selected in the dialog.
- Otherwise the first function box in the list will be selected in the dialog.

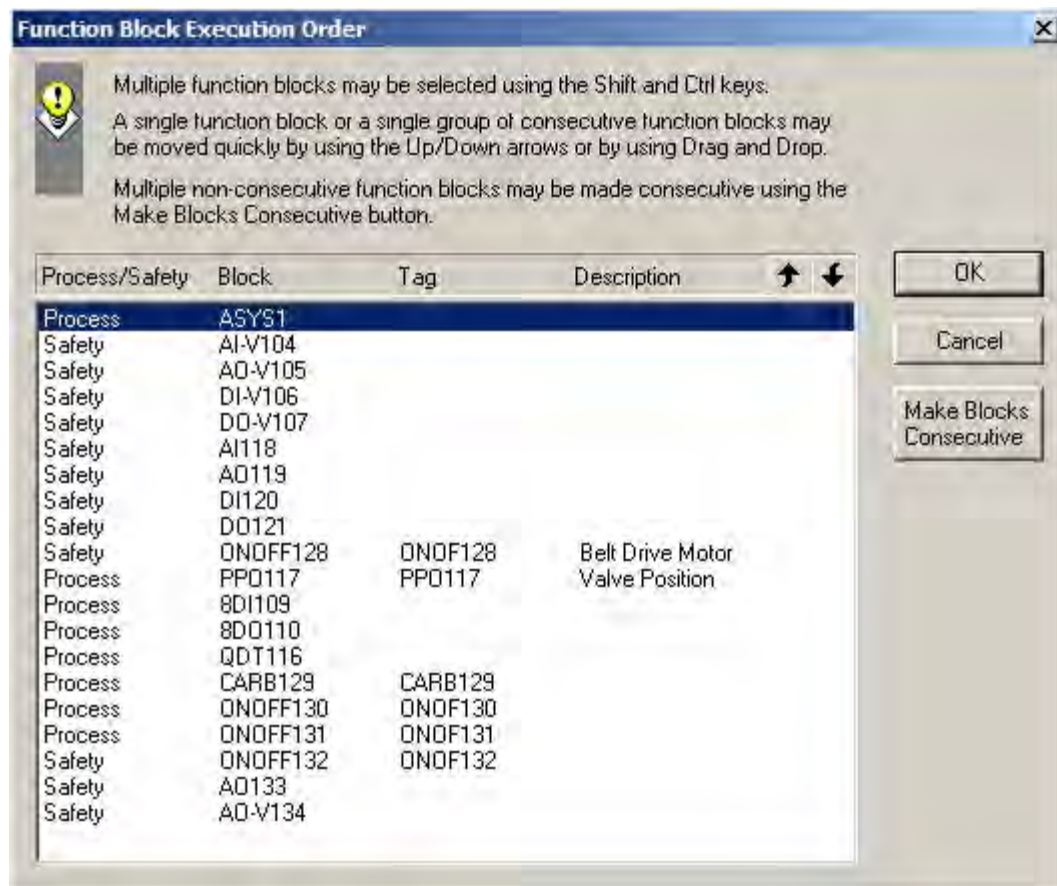

For controller configurations that support the SIL Safety standard, the function blocks in the Process and Safety segments of the control strategy share the two execution rate systems. As a result, there is no filtering of Process versus Safety function blocks in this dialog, but the location of the function block, either Process or Safety, is shown in the first column. **Note that for non SIL configurations there is no Safety portion, so the Process/Safety column shown in the figure above will not be present.**

The relative position of the function blocks shown in the dialog list box can be selected and manipulated in a number of ways.

Single Function Block:

- Select by clicking on that function block.
- Use the up and down arrows in the list box tile bar to reposition the function block one row at a time.
- Use Drag and Drop by clicking and holding on a block and dragging it to the desired location and releasing the mouse button. Dragging to the top or bottom of the list box bounds will cause the list to scroll if the scrollbar is visible.

Consecutive Function Blocks:

- Select first function block by clicking and then select the last function block while holding down the *Shift* key while clicking.
- Use the up and down arrows in the list box tile bar to reposition the group of function blocks one row at a time.
- Use Drag and Drop by clicking on one of the selected function blocks and holding and dragging it to the desired location and releasing the mouse button. Dragging to the top or bottom of the list box bounds will cause the list to scroll if the scrollbar is visible.

Non-Consecutive Function Blocks:

- Select the first function block or consecutive group of function blocks as indicated above. Add additional function blocks by holding down the *Ctrl* key while clicking.
- Make all of the selected function blocks have a consecutive execution order, starting with the position of the first selected function block, by clicking on the **Make Blocks Consecutive** button.
- **Note that neither the Up and Down arrows in the list box title bar or Drag and Drop work with this selection method.**

When all function blocks have been repositioned, click on the **OK** button to enforce the new execution order, or click on the **Cancel** button to revert back to the existing execution order. When the new execution order is enforced, the new Block Execution Order numbers will be assigned consecutively starting from 1, so any previous gaps in the execution order numbers will be eliminated.

See also "[Tag Order](#)"

Event Details

The **Event Details** dialog box enables you to enter details for the tag selected when you configure events. The block number and output number are listed across the banner. The Tag name and tag descriptor is listed in field below the banner.

Events do not have multiple priorities like alarms. They are considered a lower priority than alarms.

Details include:

E Mail Notification of events on a point by point basis. (Check the box to allow Email notification) The E-mail will be sent:

- if an event occurs on a point configured to send E-mail.
- to any/all of the 3 E-mail addresses that have events assigned. **Event priorities** are always indicated as "1"

Store to OI Archive List -OI Event File on the data archive disk on an event by event basis

Display on OI - presentation on OI Status line and Event Summary display

Trigger Direction – ON – Event on rising edge (Off-to-on transition)

OFF – Event on falling edge (off-to-on transition).

(click on radio button to select)

E-Mail Notification



opens the **E-Mail Notification** dialog box. It lets you configure up to three E-Mail addresses per controller configuration for Alarm and Event notification.

There are two tabs on the dialog Box.

General Tab

FROM The **Controller name** is configured by the builder of the Configuration file [Read Only]

SUBJECT Enter an Event Subject (up to 31 characters)
Enter an Alarm Subject (up to 31 characters)

To List Tab -

Enter up to 3 configurable E-Mail addresses.(32 characters per addresses)

For each Email address check the Alarm/Event priorities you want the E-mail address to receive.

Events do not have multiple priorities like alarms because they are considered at a priority lower than all alarms.

Alarm priorities were set during "Alarm Group Configuration" under "Alarm Details"

- 2 = Low Priority Alarm
- 3 = Medium Priority Alarm
- 4 = High Priority Alarms
- 5 = Emergency Alarm

The priority of an event is always indicated as "1" - (see Event Configuration)

Attention: See "Set Controller Network Parameters" and follow the wizard to set up a SMTP mail server IP Address.

Examples:

Somebody@somewhere.com receives **only priority 5 Alarms**
(only the check box for "5" is checked)

Aperson@somewhere.com receives **all Alarms and Events**
(all 5 boxes are checked)

People@somewhere.com receives **only Events**
(only check box for "1" is checked)

Unlock the Worksheets



opens the "Unlock Worksheets" dialog box.

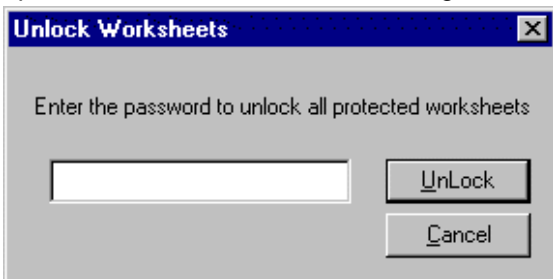

Enter the password in the field and then, press "UNLOCK".

Function Blocks Overview

Function Block Definition

A Function Block is a unit of software that performs a set of operations on its *Input Signals* and *Function Block* parameters and produces *Output Signals*. These output signals can be configured as inputs to other blocks, whose output parameters can be configured as inputs to other function blocks, and so on. By configuring and connecting all the desired input signals and function block parameters, you develop control strategies for both analog and digital operations.

A function block may represent a physical input or output, several inputs or outputs, an internal calculation or an internal function such as a PID algorithm. A single controller configuration may have up to 400(CPU C30) or 2000(CPU C50) or 5000 (CPU C70/C70R/C75) user-defined blocks. Block numbers 1-100 are reserved for specific status blocks.

Function Block Identification

Each Function Block has a type identification label of up to 5 characters assigned by during configuration. The label is an abbreviation for the operation or algorithm that the block performs and indicates the block number assigned.

Function Block Inputs and Outputs

Inputs

Function Block Inputs must be connected to a signal source. Valid sources to a function block input parameter are:

- Signal Tags
- Variables
- Soft Wires
- Constants
- Page connectors

Inputs enter the block from the top or left-hand side.

Note that unconnected inputs will default to 0 or OFF.

Outputs

Function Block Outputs are signals that reflect the results of a function block's execution.

Outputs can be connected to any number of function block inputs including inputs on the same block, but, they *cannot* be connected to:

- an output of another block,
- a variable or constant,
- an internal system value from system status block.

Outputs exit the block as straight lines from the bottom or right-hand side.

Note that unused outputs can be left unconnected.

Attention

As shown on the function block example below, there is a visual distinction between analog and digital pins,

Function Blocks Overview
 Function Block Inputs and Outputs

Analog Inputs and Outputs are indicated by a solid pin and
 Digital Inputs and Outputs are indicated by a hollow pin.

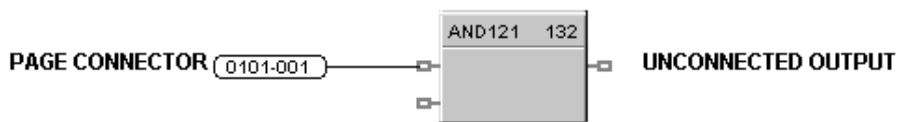
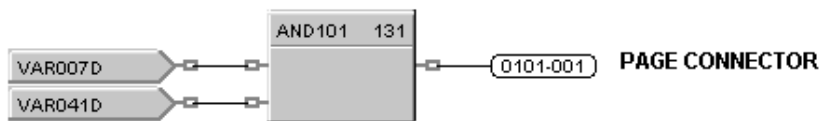
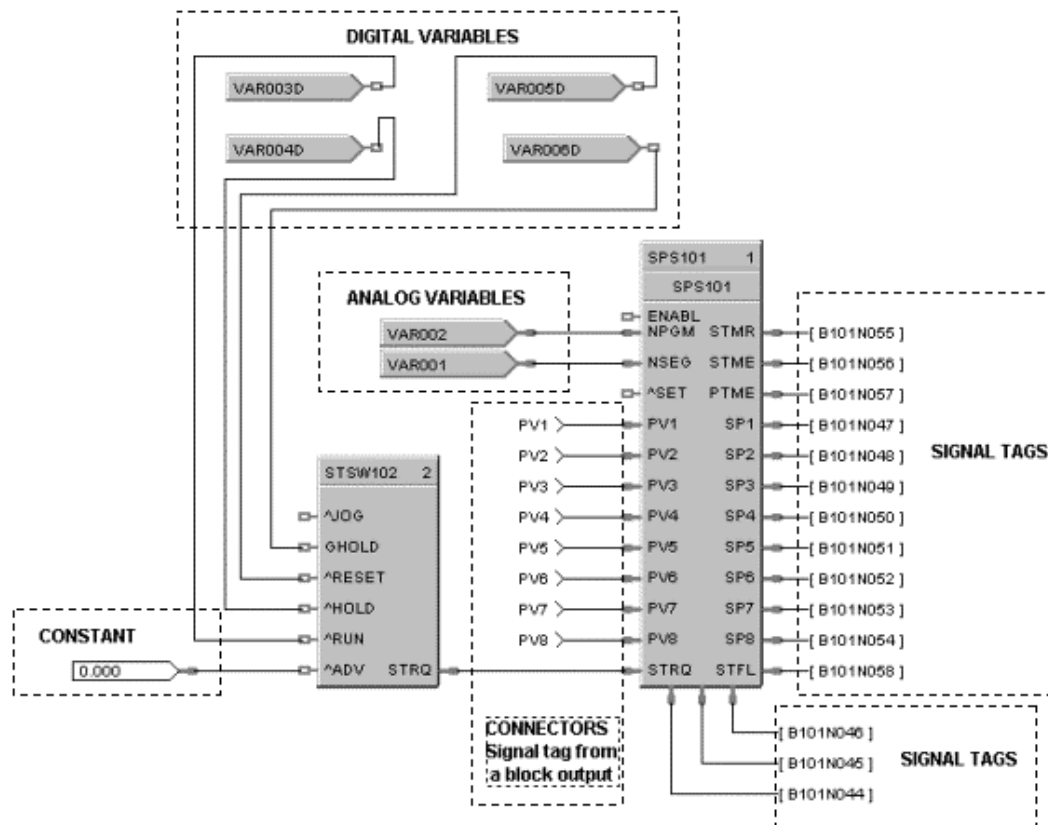

Types of Function Blocks

Function blocks come in three main classes.

Input

These process the physical inputs from the controller. Examples are Analog Input, Digital Input. They are the first stage in the controller's configuration.

Calculations and logic

These process the data from the input blocks and perform arithmetic, logic and sequencing operations. Examples are PID, Setpoint Programmer, AND, Math, etc. They are the middle stage of the controller's configuration.

Output

These process the data from the calculations and logic blocks and are the link with the physical outputs of the controller. The Analog output and Digital output function blocks convert this output information into a voltage or current, which is fed to the corresponding output hardware (such as a current output or relay).

Overview

Function blocks are graphic representations of instrument-like functions

- They are accessible through the Worksheet Toolbox on the Designer Main Window.
- They have inputs and/or outputs for connections to other blocks or functions, as applicable.
- Each function block is assigned a unique number from 101 to 500(CPU C30), 101 to 2100(CPU C50), 101 to 5100 (CPU C70/C70R/C75)

Note: Some blocks have reserved block numbers from 1 to 100

Memory usage

The amount of memory used depends on the type of block. For capacities, File Properties, Statistics.

Function Block Attributes

1 Blocks have a rectangular graphic form, which varies in size depending on number of inputs and outputs that the block possesses. The block type determines the type of operation or algorithm that the block performs.

2 Each block has type identification label of up to five characters. The label is an abbreviation for the operation or algorithm that the block performs. Each block has a number to uniquely identify the function block. A few blocks have reserved block numbers.

3 Block numbers from 101 to 500(CPU C30), 101 to 2100(CPU C50), 101 to 5100 (CPU C70/C70R/C75) are assigned in the sequence that they are programmed. This is the Block ID number. During controller operation, control blocks are executed in numerical order; lowest numbered blocks are executed first unless you change the execution order.

4 Loops, Setpoint programmers, Setpoint Schedulers, Sequencers have unique user-assigned tag names. They are used to identify values for operator displays. Note that tag names are automatically displayed in capital letters.

5 Pin labels help identify block's secondary inputs and outputs.

6 Block outputs can be labeled with a "Signal Tag Name. (Right click on the Output pin to drop a signal tag symbol) Signal point names are used to display value/state of block output signals on operator displays.

7 Many blocks have configuration parameters to tailor operation to control requirements at hand.

8 Outputs exit block as straight lines from bottom or right-hand side. Outputs can be connected to any number of control block inputs, but, they cannot be connected to:• an output of another block,• a named variable , or• a constant. Note that unused outputs can be left unconnected.

9 Inputs enter block as arrows from top or left-hand side. Inputs can be from:• An output of another block (soft wire),• A named variable (values that can be changed from the Operator Interface (max-150)) (Right click on Input pin to drop a variable)• A connector that references a signal tag or page connector (Right click on Input pin to drop a connector)• A constant that references a signal tag (Right click on Input pin to drop a constant) Note that unconnected inputs will default to 0 or OFF.

10 There is a visual distinction between analog and digital pins, Analog Inputs and Outputs are indicated by a solid pin and Digital Inputs and Outputs are indicated by a hollow pin.

11 A Digital pin without the ^ symbol indicates it is level sensitive. The pin is ON when its source signal is ON, OFF when source signal is OFF.A digital pin with the ^ symbol indicates it is rising edge sensitive. The pin is ON after its source signal changes from OFF to ON. Examples:HOLD is level sensitive ^RST is rising edge sensitive

11 Each I/O block corresponds to a physical address in a rack. That address (rack, module, channel) is shown at the top of the block.

Fast Scan Indicator

The Fast Scan Indicator is a yellow lightning bolt that has been placed somewhere on the face of the function block. See the example below.

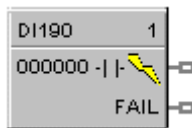

ATTENTION

For information on update rates for these blocks, refer to the "Fast Scan Function Blocks".

Using Function Blocks to Build a Control /Safety Strategy

Before You Start

The Designer software operates on a PC, independently from the controller hardware, until after the configuration is completed and downloaded. For this reason, you must identify the hardware that will be used in the controller so that the configuration constructed will match the intended I/O quantity and location in the controller.

There are two basic methods to begin configuring the controller:

1. Start with the physical I/O requirements of the controller
 - Identify the I/O
 - Configure the I/O blocks
 - Download and test the I/O first, then
 - Configure the Control /Safety Strategy, or
2. Start with the Control /Safety Strategy
 - Drop the I/O blocks as needed but leave the physical address 0.0.0
 - Download and debug the strategy, then
 - Configure the physical I/O addresses.

You can use some combination of these 2 methods, the Designer and Controller is flexible and will accommodate either approach.

See "[Rack, Module, and Channel Assignments](#)".

General Steps to Build a Control /Safety Strategy

Introduction

Configuration is the process of creating/editing a Control /Safety Strategy, best suited for your application, using Function Blocks, Variables, and Constants; Operator Interface Display assignments, Setpoint Programs, Schedules, Sequencers, and Recipes; Data Storage, Alarm and Event configuration. The configuration is essential to the controller, since it defines your control strategies and operational displays.

Following are the steps of the configuration process as determined by the tasks required.

Develop the Control/Safety Strategy using Function Block Worksheets

Step	Task
1	Select the Function Blocks, Variables, and Constants needed to meet the control /safety strategy requirements.
2	Soft-wire the outputs to the inputs.
3	Assign signal tags to block outputs needed on displays.
4	Enter annotations as needed on the diagram.
5	Configure the function block parameters needed to define the operating characteristics.
6	Configure the Execution Order.
7	Configure Setpoint Profiles, Setpoint Schedules, Sequencers, and Recipes.
8	Configure the Alarms and Events.
9	Save the Configuration File.
10	Download the Configuration File.

Step	Task

Develop the Operator Interface and Data Storage using the Display Worksheet (Legacy controllers V 4.3 and older)

Step	Task
1	Configure the Display Tag Groups.
2	Configure the Alarms and Events.
3	Configure the Display Buttons for the Operator Interface.
4	Configure the Start Up and Message Displays .
5	Configure Operator Interface Settings.
6	Configure Data Storage
7	Save the Configuration File
8	Download a Control Strategy

Notes

You can initiate a print out of your control strategy whenever you want to assist you in configuring.

The above is a general approach to building a control strategy. One of the benefits of this product is its flexibility and integration. You can develop some I/O, Control Displays, then download and repeat.

Adding, Moving, Deleting Function Blocks to a FBD

Adding

Drag and drop a function block symbol in the Worksheet Toolbox tree to the function block diagram.
The Function block will appear on the Function Block Diagram for configuration.



Selecting a drawing item

To select a drawing item, either click on it (Shift-Click to add an existing selection) or capture it in a selection net.

Auto-scrolling to select offscreen items

Click and drag the mouse to the window's edges to automatically scroll to offscreen items.

Manipulating a drawing item

<p>To form a selection net, press the left mouse button on an empty area of the drawing and drag the mouse to form a visible dotted rectangle</p>	
<p>Release the mouse button. Everything entirely within the rectangle is selected and highlighted.</p>	

Drawing Conventions

- To delete a selected item, press the DELETE key or right-click on the item and select DELETE.
- To **move** a selected item, press the left mouse button on an already selected item and drag the selection to the desired location on the function block diagram.
- To **copy** a selected item, use the CUT, COPY, and PASTE functions on the EDIT menu or Toolbar or right-click on the item and select the desired menu item.
- To **abort** a move operation, press the ESCAPE key before releasing the mouse.

Function Block Changes

If a function block is **deleted**, Designer does not re-use the block number.

If a function block is **added**, Designer uses the highest current block number + 1.

Restrictions:

When a configuration uses the last block number (500 or 2100) and you try to add another block, Designer will prompt you to "de-fragment" the table and recover previously deleted blocks. **The next configuration download to the controller following the defragmentation process requires a Cold Start.**

Connecting/Disconnecting Blocks

Introduction

A control strategy is created by connecting function blocks to each other -(Softwiring).

Connecting

To connect two blocks, you must softwire a block's output pin to the other block's input pin (or vice versa).

CAUTION

In pre-2.0 configurations, if a function block is (inadvertently) placed on top of another block with pins touching, wires connected to the touching pins may follow the wrong block, when the block again moves. In other words, the connections you see may not be the connections you actually get.

SOLUTION: Place drawing items so their boundaries do not touch or overlap. When moving drawing items groups, release the group over empty diagram space.

The outputs are always on the right or bottom of blocks; inputs are always on the top or left of the blocks.

Double click at the end of a block's output (or input) pin. A single segment wire will adopt a straight or "L" shaped route.

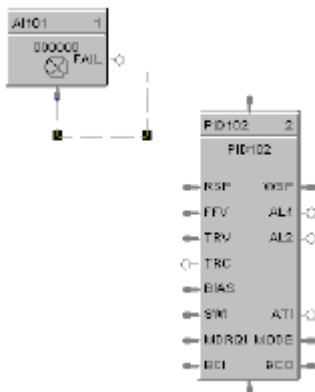

You can click anywhere on the drawing to make a wire vertex and continue to either another vertex or a block pin.

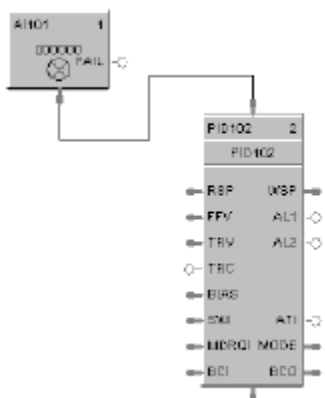

A wire can have up to eight vertices including endpoints.

You can connect two or more wires to the same output pin.

Repositioning

To reposition an existing wire:

Click on the end point of the wire to be repositioned. It will be highlighted in a dotted line showing each vertex.

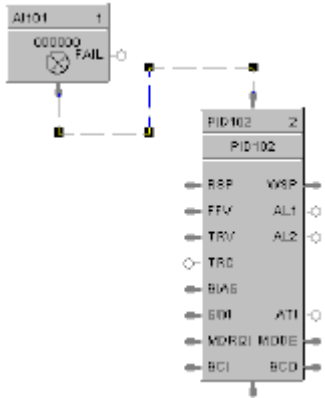

Click on a vertex and drag into the new position and release

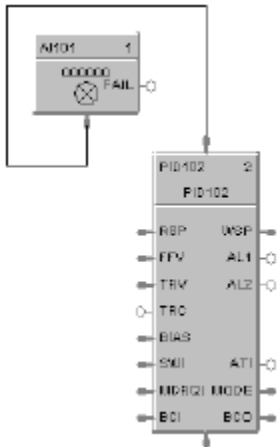

NOTE: A single "L" shaped wire cannot be repositioned. If you must alter the routing, delete the wire and add one with a vertex.

Disconnecting

To disconnect an existing wire:

Click on the end point of the wire to be deleted. The wire is highlighted.

Pull down the "EDIT" menu and select "Delete", or press the DELETE key.

NOTE: A single "L" shaped wire cannot be repositioned. If you must alter the routing, delete the wire and add one with a vertex.

See also

Wire nodes

Adding a Variable

There are two types of variables; Analog and Digital.

Procedure

Right-click on an Input pin and select "Drop Analog Variable" or "Drop Digital Variable" from the dropdown list

OR

From the Worksheet Toolbox group "Other Items", drag and drop the Variable symbol to the function block diagram.

The Variable symbol will appear on the Function Block Diagram for configuration.

Analog Variable



Double click on the symbol to open its properties dialog box. Enter:

Name and Descriptor

Decimal Places (1-5)

Engineering Units

Decimal Places

Initial Value

Also displayed is the item's default Modbus address and data type, followed by any user-defined addresses.

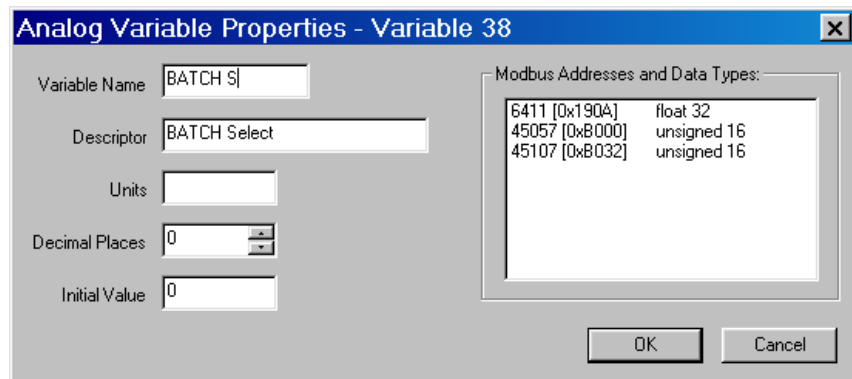

Digital Variable

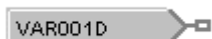

Double click on the symbol to open its properties dialog box. Enter:

Tag Name and Descriptor

Off Label

On Label

Initial Value (Off or ON)

Also displayed is the item's default Modbus address and data type, followed by any user-defined addresses.

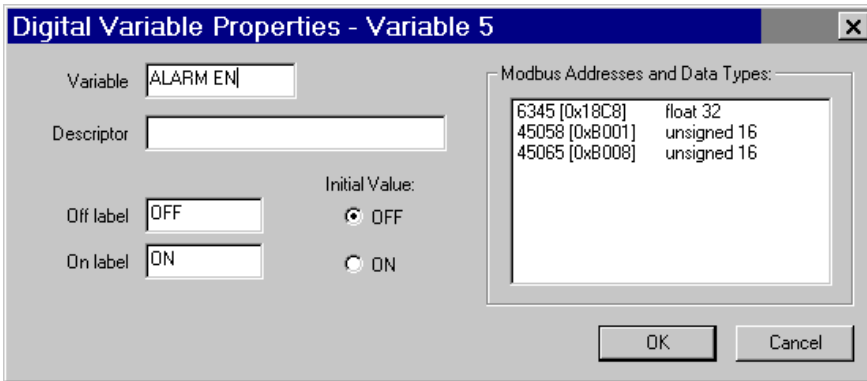

Adding a Numeric Constant

Procedure

Right-click on an Input pin and select "Drop Constant" from the drop-down list

OR

From the Worksheet Toolbox group "Other Items", drag and drop the Numeric Constant symbol to the function block diagram.

The Constant symbol will appear on the Function Block Diagram for configuration.

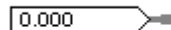

Numeric Constant **symbol**

Double click on the symbol to open its dialog box. Enter Numeric Constant value.

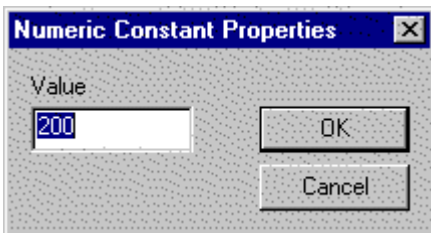

Click "OK".

Hint

To save the number of numeric constants used when a given constant is used more than once, connect a signal tag to the output pin of the constant and use a connector object as the input pins of the appropriate blocks.

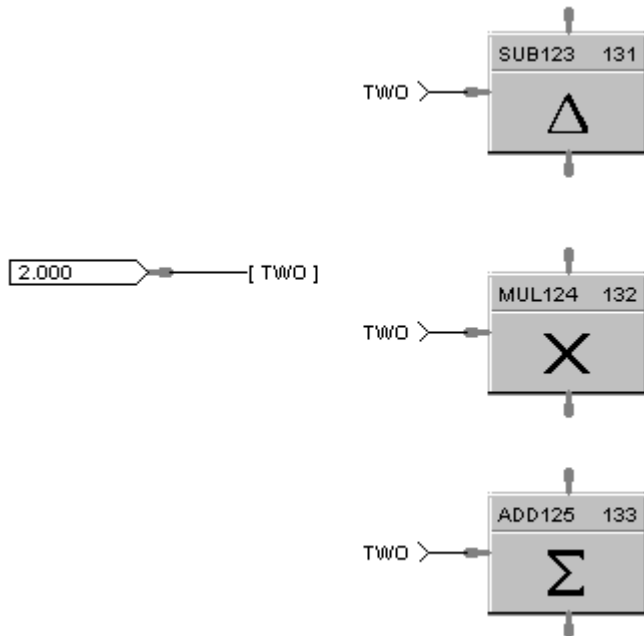

Adding a Connector

Procedure

Right-click on an Input pin and select "Connector" from the drop-down list

OR

From the Worksheet Toolbox group "Other Items", drag and drop the Connector symbol to the function block diagram.

The Connector symbol will appear on the Function Block Diagram for configuration.

Connector symbol

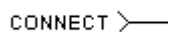

Double click on the symbol to open its dialog box. Enter:

Connector Name

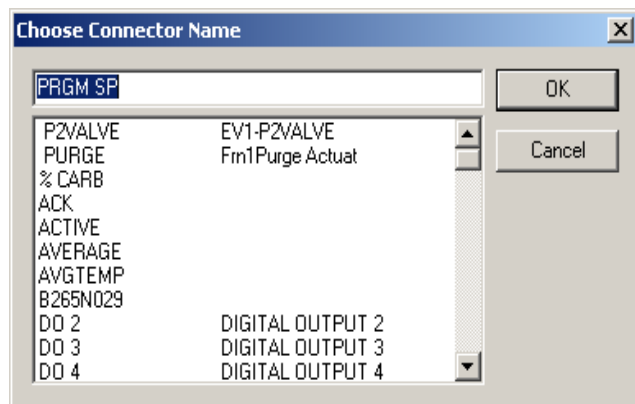

Click 'OK'.

Variables

A variable is a named diagram item, capable of holding a single analog or digital value. The value can be connected to function block inputs with a softwire. The value can be changed through any of the following:

- Entry at the Operator Interface
- Loaded through a recipe
 - Either at the operator interface or programmed in the control strategy using a recipe load block.
- Over a communications link from a peer controller or from a supervisor host.

Wire Nodes

Note: The Wire Node feature is available only in configurations for HC900 C30/C50 revision 2.0x and higher.

Introduction

 A wire node lets you distribute an output signal to multiple input pins. The wire node has 4 pins; any one pin can be connected to an output signal (this action defines the pin as the input pin of the wire node and the pin is marked with an arrow head), the other three pins of the wire node are then automatically defined as output pins and can be connected to input pins of function blocks or other wire nodes. Note that multiple soft wires can be connected to each of the three output pins of the wire node, so you can distribute an output signal to more than three input pins on function blocks or other wire nodes using just one wire node. Also note that you can wire an input connector to the input pin of a wire node. This input connector can refer to either a signal tag or a page connector. This is useful if you want to distribute a signal on one page or worksheet to multiple places on another page or worksheet."

Procedure

Right-click on white space in your function block diagram and select "Drop Other Items..., Wire Node"

OR

From the Worksheet Toolbox group "**Other Items**", drag and drop the Wire Node symbol  to a blank spot on the controller configuration.

Double-click any pin on the wire node, then click on the output signal you want. You can also double-click on the output signal first and then click on any pin on the wire node. An arrow appears showing logic flow direction. You can connect the input pin of a wire node to an output signal of a block, variable, signal connector, or numeric constant but not to a signal tag or page connector.

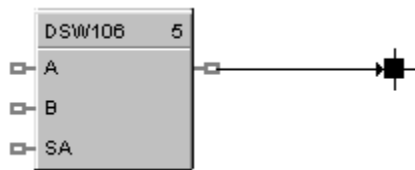

Double-click on any remaining wire node pin, then click on the desired input pin to complete the connection. Repeat for the remaining wire node pins.

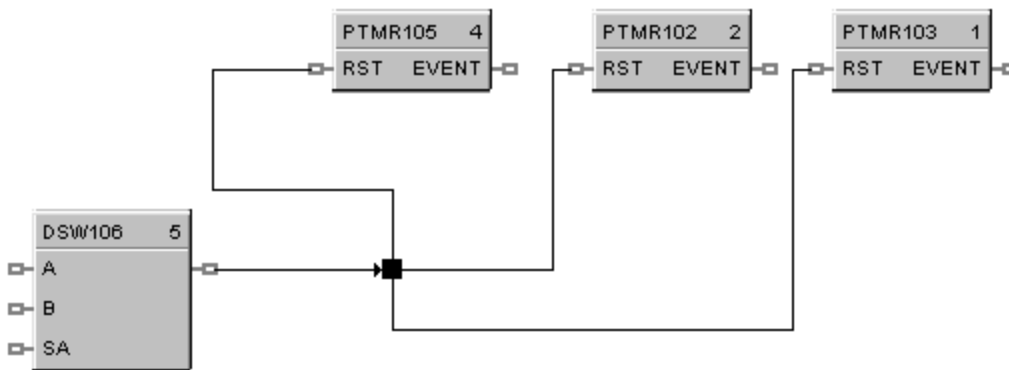

If you need an output signal to go to more than 3 inputs, use additional wire nodes. You may use any number of output pins of a wire node.

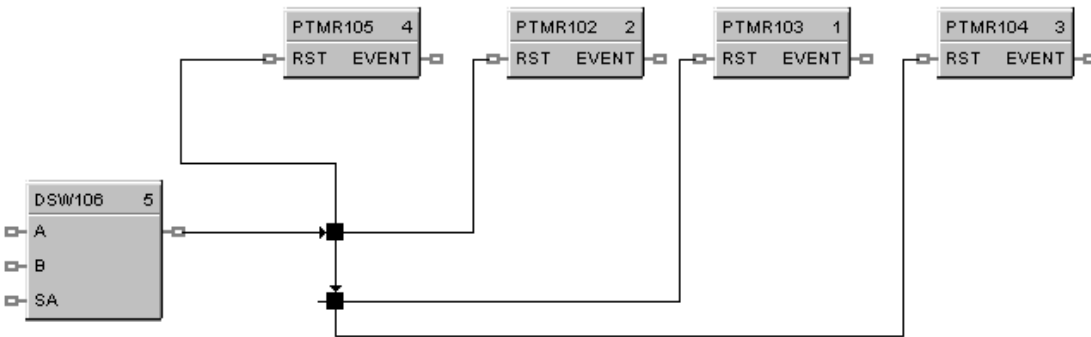

Loop-backs are allowed.

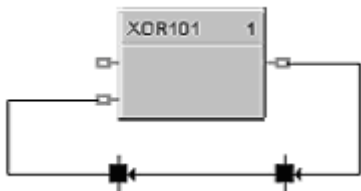

You can drag a wire node without breaking its connections.

Signal Tags

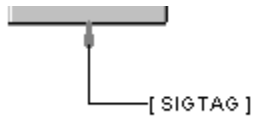

Introduction

Signal tags are users assigned names that can be associated with the output of any item. They can be:

- Assigned to displays

- Used to connect discontinuous wires to other block inputs using connectors in the same or in another FBD Worksheet.

- Assigned to Data Storage

- Used for Peer-to-Peer communication between multiple-networked controllers using Modbus communications.

- To identify important block output pins for monitoring.

Procedure

Right-click on an Output pin and select "Signal Tag". Drops the signal tag down and automatically connects it to the pin. Skip to Step 4.

OR

From the Worksheet Toolbox "**Other Items**", drag and drop the Signal Tag symbol  to the controller configuration

OR

Right-click on white space in your function block diagram and select "Drop Other Items..., Signal Tag".

The Signal Tag symbol will appear on the Controller configuration and **the cursor will change to the software cursor.**

Attention: You cannot drop a signal tag directly onto an output pin. Drop it away from the pin, then software it to the pin. Once it is connected, you can move the signal tag to any location.

Place the crosshairs on the output pin and click to connect the tag to the output (dotted Line). You can add vertices like a software.

Double click on the tag name area to display the signal properties dialog box.

Analog Signal Tag

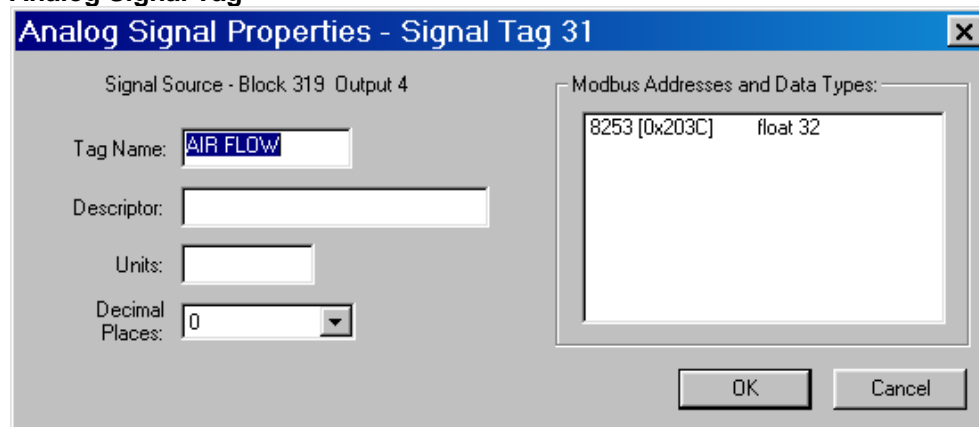

Enter:

- Tag Name
- Descriptor
- Select Decimal Place [0-5]
or select exponential notation (i.e. display Trend Points Logarithmically)
- Engineering Units

Also displayed is the item's default Modbus address and data type, followed by any user-defined addresses.

Digital Signal Tag

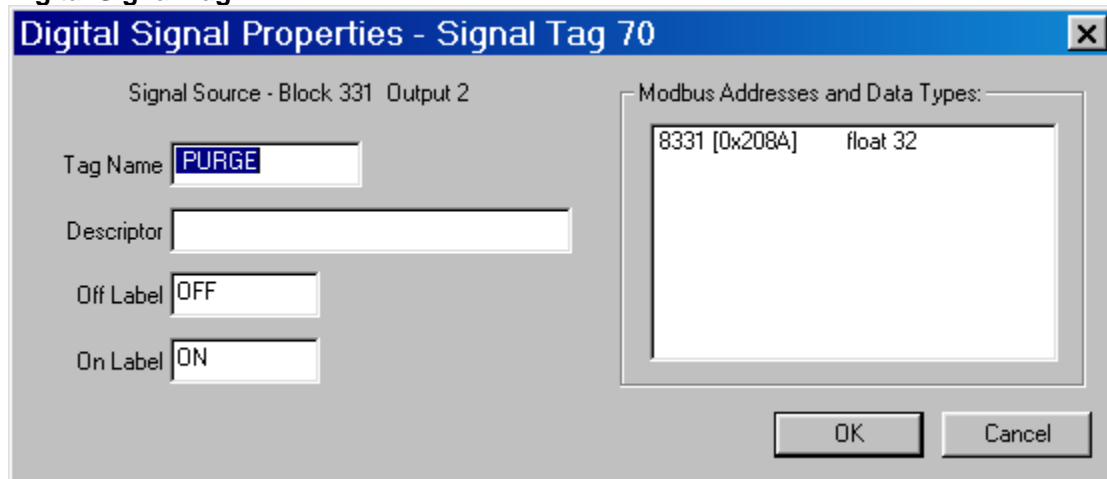

Enter:

- Tag Name
- Descriptor
- Off Label
- On Label

Also displayed is the item's default Modbus address and data type, followed by any user-defined addresses.

An input signal tag connector can be changed to another signal tag connector or to a page connector. Double-click on the assigned input connector to see a selection of different signal tags or page connectors.

Page Connectors

Note: The Page Connector feature is available only in configurations for HC900 C30/C50 revision 2.0x and higher.

Introduction

A Page Connector lets you connect a signal from a worksheet page to another page and across worksheets. Page connectors are similar to signal tags except they do not appear in any signal tag lists. They are tags but they have no descriptors, decimal places, or alarm/event notification properties. You can rename them.

Page connectors can be monitored. The Watch Summary window has a tab for page connectors.

Procedure

Right-click on white space in your function block diagram and select "Drop Other Items..., Page Connector",

OR

From the Worksheet Toolbox group "**Other Items**", drag and drop the Page Connector symbol  to a blank spot on the controller configuration.

OR

Right-click on a function block output pin. Drops the page connector down and automatically connects it to the pin. Skip to Step 3.

Click any output pin of any function block to make a connection. (An output pin can have multiple signal tags and/or page connectors attached to it.) The output page connector appears with a

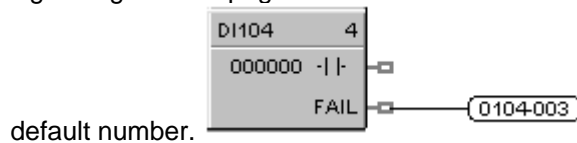

Drop a connector . Use any of the following methods.

Right click on the white space of a function block worksheet,

OR

Right click on a function block input pin

OR

Drag and drop the connector from the Worksheet Toolbox.

Double-click on the connector . A list of signal tags or page connectors is shown. Display all page connectors and pick one to assign to the input. When you pick one the unconnected input

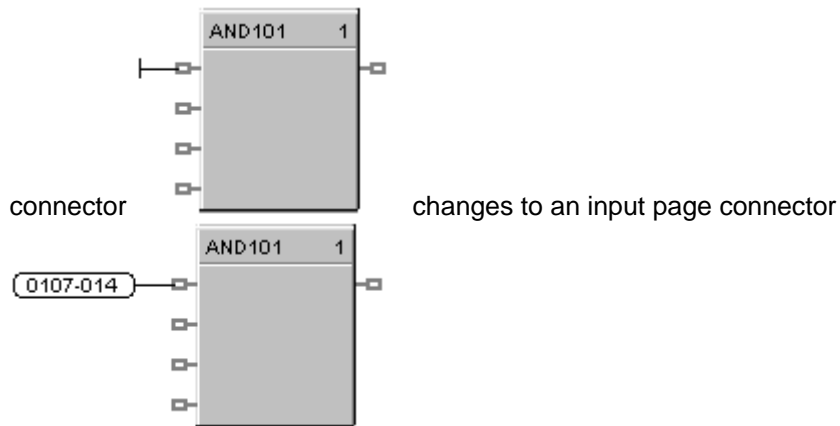

Double click on the page connector tag name area to view or change the page connector properties:

Analog Page Connector Properties

- Tag Name
- Engineering Units

Digital Page Connector Properties

- Tag Name
- Off Label
- On Label

Page connector tag names must be unique.

An input page connector can be changed to another page connector or to a signal tag connector. Double-click on the assigned input connector to see a selection of different signal tags or page connectors.

If you change the name of an output page connector you break the connection to any connected input page connectors. Input and output page connector names must match exactly to be a valid connection. Unconnected input page connectors are displayed as

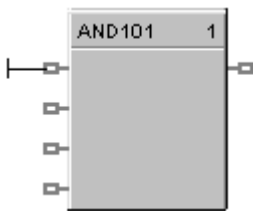

Text String

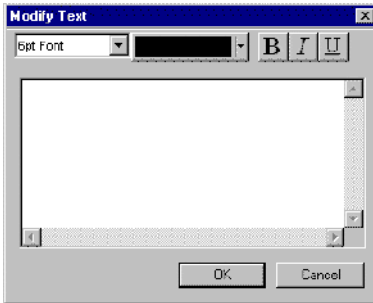

This is part of the Other Items category.

Introduction

You have the option to enter descriptive data on the Function Block Diagram. V Any entered data has no effect on the operation of the Controller.

Procedure to Enter a Text String.

Step	Action
1	From the Worksheet Toolbox group "Other Items", use the left Mouse button to click on the T (text) symbol, hold the button down, drag the symbol to the function block diagram and release the mouse button. The "Modify Text" dialog box will appear on the Function Block Diagram.
2	Select a Font size (6, 10, 12, 16 pt) Select a Color (black, blue, red, green) Select Bold , <i>Italics</i> , or <u>underline</u> or <i><u>all three</u></i> You can change the default font characteristics for Text Annotations. See " Changing the Default Annotations Attributes "
3	Key in the desired text in the field, then click OK. You can use carriage returns for multiple lines. The text will appear on the diagram in a dotted-line box.
4	Click and hold the cursor in the box and move the text string to the desired location.
5	To enter another text string, repeat the above steps.

Editing Text

To edit existing text, double click the text. The "Modify Text" dialog box will reopen. You can delete text or cut, copy, and paste text from one "Modify Text" dialog box to another. Use the 'right' mouse button menu while the mouse cursor is in the edit box.

Changing the Default Annotation Attributes

You can change the default font characteristics for Text Annotations. These include

- Font Size
- Color
- Bold/italic/underline Settings

Configuration Procedure

1. From the "Edit" menu, select "Options".
2. Select " Default Annotation Attributes". The "Default Text Attributes" dialog box opens.
3. Select a **font size** from the dropdown menu.(6,10,12,or 16 points)
4. Select a **color** from the drop-down menu. (black, red, green, or blue)
5. Click on a button to select **Bold**, **Italics**, or **Underline**, or all three.
6. Click OK to save the selections for default text annotations

Conventions

Drag and Drop

To add a function block to a controller configuration, select the desired block from the menu tree. Press and hold the left mouse button and drag the block over to the diagram on the right hand side of the screen. Position the block and then release the left mouse button to drop the item into place.

Accessing Context Sensitive Help

While in a Controller configuration, click the **right** mouse button to allow access to Topic Help, Monitor functions, Cut, Copy, Paste functions and Properties Dialog Boxes.

Right Mouse Click

See page 29.

How to Configure Function Block Parameters

Accessing Block Details

Overview

After function blocks are placed on the function block diagram, they can be configured

Most dialog boxes are simple dialog boxes that contain the assigned block number and execution order of the block.

Some dialog boxes contain various parameters and options that are configured based on the particular type of function block. For example: I/O blocks contain Rack, Module, and Channel addresses and function block configuration parameters. Certain function blocks contain a Modbus address.

Tabbed dialog boxes will be used for the most complicated blocks (for example, PID) to organize the data for you.

Procedure

To access Block Properties, double click on the selected function block and the corresponding dialog box(es) will be displayed.

The dialog box(es) display(s) all parameters having to do with the selected function block.

Enter a physical address if applicable.

Enter any Tag Names

Enter all parameters on each tab, if present.

When all the changes are entered, click OK to enter, or CANCEL.

While in a Controller configuration, click the right mouse button to allow access to Topic Help, Monitor functions, Properties Dialog Boxes, and Cut, Copy, and Paste functions. Some function blocks let you customize their Modbus address.

Function Block Address

Addresses identify physical connection points for field wiring to Input/Output modules.

Assign a unique address to each I/O block. See page 4.

User Assigned Tag Names

Some blocks have unique, user-assigned tag names.

They are used to identify values for operator displays.

When configuring displays you will be able to select from a list of tag name groups that you have assigned. (See "Configure Tag Order")

Enter a Name in the "Tag Name" field.

Tag names are automatically displayed on the block in capital letters

Function Block Parameters

All Function Block Parameters are values that influence the function block's execution.

To enter a parameter:

- Click the cursor on the desired parameter field to highlight it.
- Key in the desired value, make a selection from any drop-down menus, or select a radio button, if necessary.
- Click OK when configuration is complete.

Function Block Diagrams

Overview

Function Block diagrams let you build your control /safety strategy graphically right on the Designer Window. It provides a full complement of SAMA-style symbols that we call Function Blocks that can be "softwired" to each other. It also includes signal tag generation capability for resident control data that can be linked to displays and other software programs.

Function Block Diagram Rules

1. Do not place Function Block icons over another or overlap pins.
2. A pin output may be soft-wired to any number of inputs of other blocks.
3. You may change direction for soft-wiring with a left mouse click (up to 6 direction changes).
4. You may use "Signal tags" and "Connectors" to substitute for soft-wired connections and for reference across diagram pages.(right click on the input or output pins)
5. You may move a block or group of blocks by selecting blocks or "boxing a group of blocks".
6. You may cross soft-wires.
7. You can cut, copy, or paste (**from File menu or Right-click on the diagram**) one or more blocks by selecting or "boxing" within an application or between active applications (allows function block libraries to be stored).

Saving A Configuration File

To Save an Existing File



Select "SAVE" from the "FILE" menu or from the Main Toolbar

If there **are no** unconnected inputs that need to be set to OFF or 0, the data is saved automatically.

If there **are** unconnected inputs that have not been previously set to OFF or 0, The Designer will notify you that there are unconnected inputs and ask if you want to see a list of unconnected inputs.

Click "Yes" to view the summary of unconnected inputs.

Click "Log File" to save the list to a text file, if desired.

To Save a New File or Save the File as a New Name

Select "SAVE AS" from the "FILE" menu. The "Save As" dialog box will open.

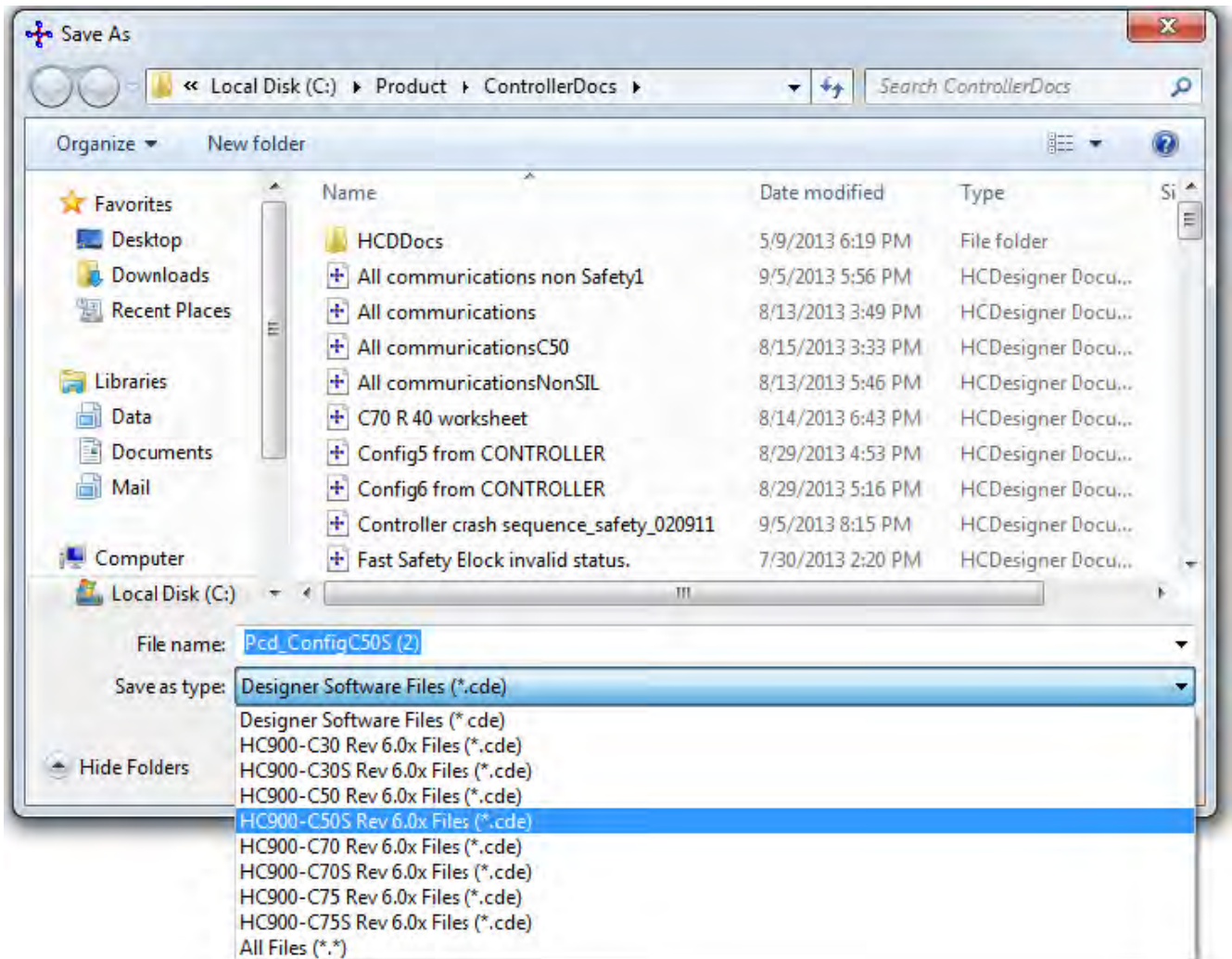

Type in the new file name in that field.

From the drop-down menu in the "Save as Type" field, select the configuration type depending on the controller you have.

If there **are no** unconnected inputs that need to be set to OFF or 0, the data is saved automatically.

If there **are** unconnected inputs that have not been previously set to OFF or 0, The Designer will notify you that there are unconnected inputs and ask if you want to see a list of unconnected inputs.

Click "Yes" to view the summary of unconnected inputs.

Click "Log File" to save the list to a text file, if desired.

Utilities Worksheet

Overview

This **Utility Worksheet** has three areas that let you perform a variety of tasks for maintaining the HC900 Process Control and setting up your PC's Communications Ports.

Controller Utility Functions

The upper part of the Utilities Worksheet contains the Controller Utility Functions. It has list of Icons that will launch dialog boxes for the following utilities:

- Diagnostics
- Uploads
- Downloads (Configuration, Controller Firmware, Scanner Firmware)
- Set Controller Serial Port
- Calibrate Modules
- Set Controller Mode
- Set Controller's Network Parameters
- Set Controller Time
- Data Storage Utility
- Back Up Controller Information or Restore Controller Information
- Manually Write Database to Flash

Current PC to Controller Connection Settings

- Displays Comm Port and Address information. Lets you select a Port and Controller Network Address from the drop-down menus.
- Allows you do a Loopback to check the communications connections.
- Allows you view and reset the communications statistics.
- Allows you to Dial/hang up the modem.









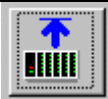

PC Port Setup

Lets you set up a Network Port and up to 8 Comm Ports or Modems.

Controller Utility Functions

The upper part of the Utilities Worksheet contains the Controller Utilities Functions. It has list of Icons that will launch dialog boxes for the following utilities:

ICON	FUNCTION	REFERENCE
	Controller Diagnostics*	Select from drop down menu: (options are only available in Monitor Mode) Controller Diagnostics. See page 219 Rack Diagnostics – see page 227 Controller Ports Diagnostics – see page 235 Modbus Port Diagnostics Modbus Master (Serial) Port Diagnostics – see page 248 Modbus/TCP Initiator Port Diagnostics – see page 251 Forced Blocks – see page 198 Redundancy ... Redundancy System – see page 281 Redundancy Link - see page 282 Lead CPU – see page 283 Reserve CPU – see page 286 Scanner 2 Link – see page 287
	Upload from Controller*	Configuration Upload transfers a configuration FROM the controller TO the PC. See page 36.

ICON	FUNCTION	REFERENCE
	Download to Controller*	Downloads a saved configuration, controller firmware, or scanner firmware from FROM the PC TO the controller. See page 37 and page 40.
	Set Controller Port**	Menu selection lets you Set Protocol for controller's configuration ports.
	Calibrate Controller **	Click to open the Calibrate dialog box. Four Tabs on the Dialog Box: AI Channel - see " Calibrate AI Channel ". CJ Temp - see " Calibrate CJ Temp ". AO Channel - see " Calibrate AO Channel ". PPO Block – see " PPO Block Calibration "
	Set Controller Mode**	Click to open the Set Controller Mode dialog box. Read the current mode, select a new mode, then write the new mode to the controller.
	Set Controller Network Parameters*	A Wizard interface guides you through connecting to a controller in order to view and edit the controller's network parameters In order to change the controller's network parameters, the controller must be in PROGRAM mode.
	Set Controller Time**	Click to open the Set Controller Time dialog box.
	Data Storage Utility	(Available only for software revision Rev 4.4 and earlier.) Click to open the Data Storage Utility dialog box. Select a Removable Disk Drive Group Number and Trend group number. Press "Initialize" to prepare the disk for storage.
	Back Up Controller Information	Backs up controller's configuration and port settings. See Back Up Controller Information.
	Restore Controller Information	This button visible for open backup files only. See Restore Controller Information .
	Manually Write Database to Flash	See Manually Write Database to Flash.

* *These functions prompt you to select a PC port to which to connect.*

** *These functions communicate to a controller by using the PC Port displayed in " Current PC to Controller Connection Settings".*

Uploading a File from the Controller

See page 36.

Download a File to the Controller

See page 37 and page 40.

Set Controller Serial Ports

Use this feature to set the RS232 (legacy controllers) and RS485 ports protocol.



has two tabs—Serial S1 (RS232) and Serial S2 (RS485)—each with the following settings.

Honeywell ELN: Default protocol

Modbus RTU Master: Select to set controller up as a master.

Modbus RTU Master - Advanced: Provides enhanced data throughput for applications where the HC900 is being used in conjunction with a “Modbus-to-fieldbus” gateway device. See page 140 for details.

Modbus RTU Slave: Select to set controller up as a slave.

Slave Type:

Multidrop--select when using more than one slave on the selected PC port.

Point to point--select for one slave

Modem--select when using a modem between the master and slave.

Slave Address: Enter 1-247, or 255.

Modbus Slave Double Register Format: Each IEEE 32-bit floating point number requires two consecutive registers (four bytes, MSB=4, LSB=1 in byte order below) starting with the register defined as the starting register for the information. The stuffing order of the bytes into the two registers differs among Modbus hosts. To provide compatibility, the Double register format is configurable. Selections are:

FPB Floating Point Big Endian Format Byte order - 4, 3, 2, 1 (Default)

FP LB Floating Point Little Endian with byte-swapped Byte order - 2, 1, 4, 3

FP BB Floating Point Big Endian with byte-swapped Byte order - 3, 4, 1, 2

FP L Floating Point Little Endian Format Byte order - 1, 2, 3, 4

Port Enable: Enables or disables port.

Speed (bps): Select Baud rate. All slaves on the same PC port must be the same.

Modbus parity: Odd or even. All slaves must be the same.

Modbus stop bits: 1 or 2. All slaves must be the same.

Set – Activates settings. If you changed the controller's Baud Rate via a PC RS232 Comm Port, your PC will no longer communicate with the controller. In this case, you are prompted to detect the controller's Baud Rate. This feature will synchronize the PC's Comm Port with the controller and set the PC Baud Rate to the correct Baud Rate.

Modbus RTU Master - Advanced Setup

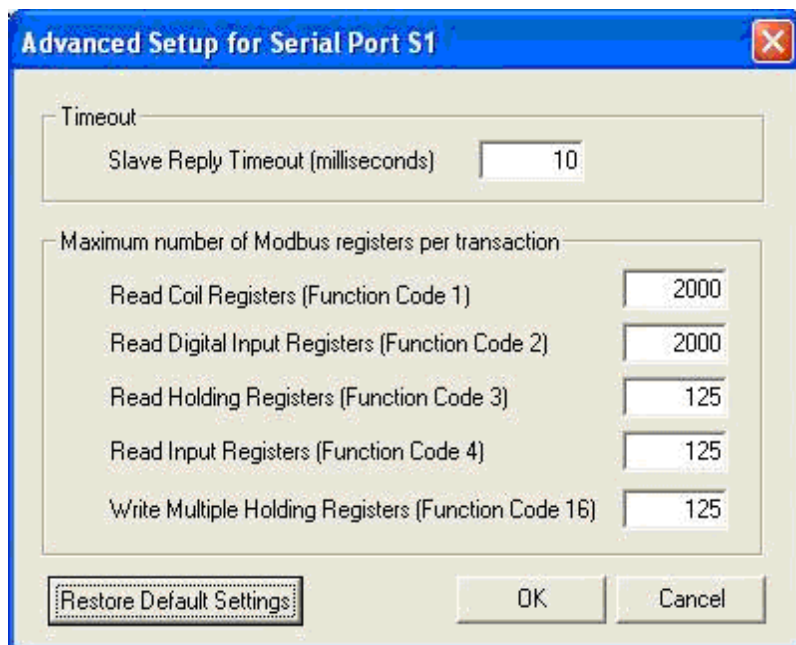

Overview

The Modbus RTU Master Advanced protocol provides enhanced data throughput for applications where the HC900 is being used in conjunction with a “Modbus-to-fieldbus” gateway device. In these applications the gateway acts as a Modbus slave to the HC900 controller. The Modbus data is connected into the HC900 control strategy using the Modbus Read, Modbus Write, and Modbus Slave function blocks.

In order to achieve the enhanced data throughput, the HC900 communicates with the gateway using large packets of contiguous Modbus register addresses. This packetization technique allows the HC900 to exchange data with the gateway at rates up to the analog cycle rate of the controller (depending on the operating characteristics of the gateway device). The packet sizes can be adjusted to match the specifications of the gateway slave device.

Differences from standard Modbus RTU

There are several important ways in which the Advanced protocol differs from the standard Modbus RTU Master protocol:

1. Under the Advanced protocol the Modbus register data is written to the slave devices during every Modbus Master scan cycle. This behavior is different than the standard Modbus RTU Master protocol, where the data is written only when the slave block’s Enable pin is ON.
2. The Enable pins on the Modbus function blocks do not control when the register data is written to the slave device. Instead, they control the value that is written to the block. For example, if a Modbus function block has the value 10 on its Write pin and the Enable pin is ON, then a value of 10 is written to the slave device. If the Enable pin is changed to OFF, the HC900 controller will continue to write a value of 10 to the slave device once every Modbus Master scan cycle. If the value on the Write pin is changed to 100 while the Enable pin is OFF, the controller will continue to write a value of 10 to the slave device. The next time the Enable pin is changed to ON, the controller will write the value 100 to the slave device.
3. Modbus Register write operations are performed using Modbus Function Code 16 (Preset Multiple Write). The number of registers written in a single transaction is based on the Advanced Setup settings for the serial port.

4. If there are “gaps” in the Modbus register addresses referenced within the HC900 configuration, the controller will write a value of zero to the “undefined” registers. For example, if Modbus Registers 1 and 10 are assigned to Modbus function blocks but Registers 2 through 9 are not, the controller will write zeroes to Registers 2 through 9.

The Advanced protocol can be used in any Modbus Master application that can accommodate these differences.

Factors affecting scan time

Using the Advanced protocol, the HC900 controller can potentially scan all of the Modbus registers on the serial link at a rate that is equal to the analog cycle time. The actual scan time for any given application is affected by the following factors.

1. Characteristics of the slave devices (e.g., the maximum baud rate, the message turn around time, support for Modbus packets, the maximum allowable packet size, etc.).
2. Configuration of the Modbus slave blocks.
3. Programmed baud rate of the serial port.

The Modbus Master scan time is adjusted automatically by the HC900 at run-time; no user intervention required. The actual scan time of the link is displayed on the Modbus Communication Diagnostics display in Monitor Mode.

Configurable parameters

The parameters on this dialog can be used to match the behavior of the Advanced protocol to the characteristics of the slave devices on the link. Please consult the documentation for your slave devices to determine the best settings for your application. In general, the best overall performance of the Modbus Master Advanced link can typically be achieved by using the largest possible packet sizes.

Slave Reply Timeout (milliseconds)

This parameter defines the Modbus message turnaround time for the link. It has a range of 10ms to 255ms. This parameter should be set to handle the slave device that has the worse case turnaround time on the link. If there are slave devices with turnaround times that are longer than 255ms, then the standard Modbus RTU Master protocol must be used.

Maximum Number of Modbus registers per transaction

Read Coil Registers (Function Code 1)

This parameter determines the maximum number of coil registers that can be read from the slave devices in a single transaction.

Read Digital Input Registers (Function Code 2)

This parameter determines the maximum number of digital input registers that can be read from the slave devices in a single transaction.

Read Holding Registers (Function Code 3)

This parameter determines the maximum number of holding registers that can be read from the slave devices in a single transaction.

Read Input Registers (Function Code 4)

This parameter determines the maximum number of input registers that can be read from the slave devices in a single transaction.

Write Multiple Holding Registers (Function Code 16)

This parameter determines the number of registers that will be written to the slave devices in a single transaction. Note: if there are gaps in the Modbus register addresses referenced within the HC900 configuration, the controller will write a value of zero to the undefined address. For example, if Modbus Registers 1 and 10 are assigned to Modbus function blocks but Registers 2 and 9 are not, the controller will write zeroes to Registers 2 and 9.

Restore Default Settings

This button allows you to restore the original default settings for the Advanced Setup parameters.

Note: you must click the Set button on the Set Protocol dialog to activate any changes that are made on this dialog.

Calibrate Controller

See page 153.

Set Controller Mode

Set Controller Mode lets you set the controller mode. It can only be set when the controller's mode switch is in the center "Run Mode" position.

ATTENTION: If the controller's mode switch is in one of the "Locked" positions, the mode cannot be changed from this position. It can be changed only by changing the position of the switch.



opens the **Set Controller Mode** dialog box. Follow the steps on the dialog box

1. Select a new mode - RUN, PROGRAM, or OFFLINE
2. Write the new mode to the controller. Press "Set New Mode" button
Program to Run takes some time. An Indicator on the dialog box shows the progress.

Set Controller Network Parameters



opens the "**Controller Identification Setup Wizard**" dialog box.

You can select a serial port or the Ethernet port over which the network parameters will be read/written.

The controller must be in PROGRAM mode to set the Network Parameters.

There are set up options on the wizard. The option you choose depends on how you are connected to a controller and what current knowledge you have of that controller.

Important: *before configuring your controller to work on a corporate LAN, consult with your Network Administrator regarding any corporate networking policies.*

Follow the Wizard instruction to set:

- **Network Name**
User assigned name - can be different from controller name (16-character ASCII name. It is not part of configuration.)
It is required to uniquely define a Peer group if multiple processes, each with its set of peer controllers, are on the same physical cable. The controller binds the "Network name: Controller name" to the IP address of each of its peers at run-time.
- **Local Name** (alias)
User assigned 16-character ASCII name [can be different from controller name]
It is not part of the configuration.

See Controller Identification for more info on names.

- **Modbus TCP Double Register format**
Each IEEE 32-bit floating point number requires two consecutive registers (four bytes, MSB=4, LSB=1 in byte order below) starting with the register defined as the starting register for the information. The stuffing order of the bytes into the two registers differs among Modbus hosts. To provide compatibility, the Double register format is configurable. Selections are:
 - FP B Floating Point Big Endian Format Byte order - 4, 3, 2, 1 (Default)
 - FP LB Floating Point Little Endian with byte-swapped Byte order - 2, 1, 4, 3
 - FP BB Floating Point Big Endian with byte-swapped Byte order - 3, 4, 1, 2
 - FP L Floating Point Little Endian Format Byte order - 1, 2, 3, 4
- **IP Address**
Controller Internet Protocol Address - Guaranteed unique address, assigned by the Internet Corporation of America for Assigned Names and Numbers (ICANN) IP Address includes four "Octets" (eight bits, translating to integers from 0 to 255, separated by periods). The manufacture default IP Address is 192.168.1.254.
- **Subnet Mask**
Subnet Mask defines the *netid* (Network ID) and the *hostid* (Host ID) parts of an IP Address. The *netid* uniquely identifies a network, and the *hostid* uniquely identifies a computer on the network.
The Subnet Mask can be used to partition the Network into sub-networks, using parts of the *hostid* to define new *netids*, or more correctly *subnetids*.
Portioning a network in this way enables switches and routers to use the subnetids to reduce collision domains and to promote security.
- **Gateway IP Address**
Used to forward packets to other networks and subnets. The Network Administrator typically provides this address.
- **Email Server**
Outgoing Mail (SMTP) server IP Address: If the controller is configured for E-mail notification, enter the IP Address of the (SMTP) E-mail server.

Controller Identification

The figure below shows how to uniquely identify multiple controllers on a network. Notice the controller names can be the same in both furnaces (Larry, Curly, Moe), but within the same network name they must be unique. To further distinguish controllers, use unique network names (Furnace #1 and Furnace #2). Network name:Controller name are bound to the IP address of each controller. Finally, use a local name (alias) to identify each controller to the end user. This local name is a convenient name such as for displays on the PC, it is not referred to for actual communication.

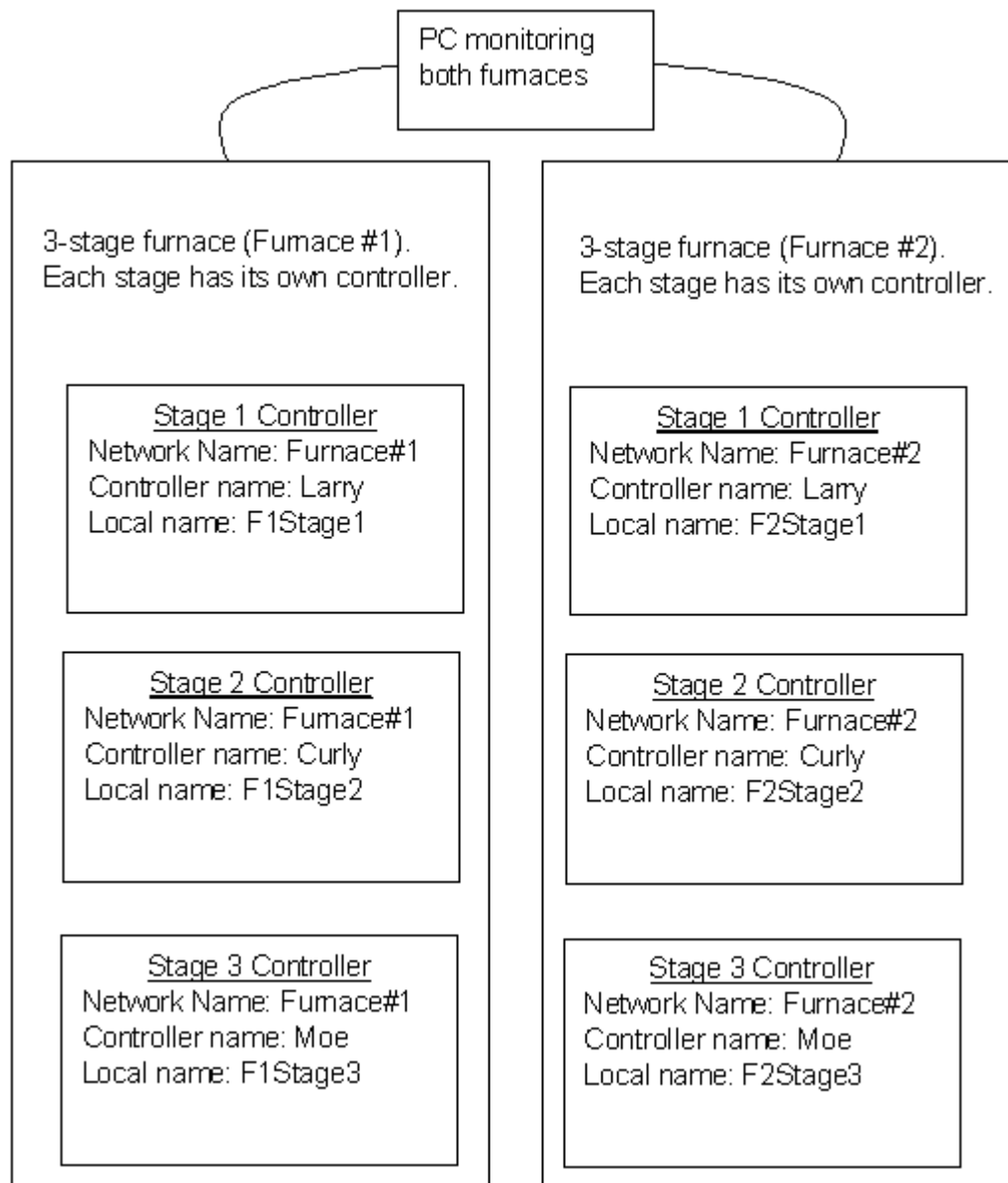

Set Controller Time



opens the **Set Controller Time** dialog box. Screens differ according to the version of HC Designer.

Version 4.0 and earlier

This window lets you set your controller's date and time.

Note: Use of Daylight Saving or Network Time Server requires Version 4.1.

Group	Item	Description	Action
PC Time	Current Date Current Time Time Zone	Indicates PC's date, time and time zone.	Read Only.
Controller Time	Current Date Current Time	Shows Controller's current date and time This is updated when you click on Set Controller Time button below.	Read only.
Select method for writing Time and Date to the Controller	Set to PC Time	PC's date and time, indicated here, will be used by controller.	Click radio button to select.
	Manually Override Time	Date and time entered here will be used by controller.	Click radio button and enter desired date and time.
	Set Controller Time	Writes PC or manual Date and Time to the controller. Current Controller Time (top of window) will be updated. A status message confirms the update.	Click to set time.

Version 4.1 and later

There are two tabs in this window.

Time and Date tab - Lets you set controller time to the PC time and assign a time zone to the controller.

Network Time Server and DST tab - Lets you assign a Network Time Server that periodically synchronizes the controller time. Lets you specify when controller time changes to Daylight Saving.

Version 4.1 Time and Date tab

Group	Item	Description	Action
Current PC Time	Current Date Current Time Time Zone	Indicates PC's date, time and time zone, including Standard or Daylight Saving.	Read Only.
Current Controller Time	Current Date Current Time Time Zone	Shows Controller's current date, time and time zone. Note: Daylight Saving, if applicable, is not shown unless Controller is in RUN mode.	Read only.
Set Controller Time and Date	Date Time	PC's date and time, indicated here, will be used by controller.	Read only.
	Use Controller Time Zone	Time zone entered here will be used by controller.	Click to select. Enter desired Time Zone.
	Use PC's Time Zone	Time zone displayed here will be used by controller.	Read only. Click to select.
	Set Controller Time	Click to write the above Date, Time and Time Zone to the controller. Current Controller Time (top of window) will be updated. A status message confirms the update.	Click to select.

Version 4.1 Network Time Server and DST tab

Use this tab to

- assign a Network Time Server that periodically synchronizes the controller time,
- specify when controller time changes to Daylight Saving.

Group	Item	Description	Action
Network Time Server	Enabled Disabled	<p>Disabled - controller's time will not be synchronized with a network time server.</p> <p>Enabled - controller's time will be periodically synchronized to a network time server in Greenwich Mean Time. Different time zone or Daylight Saving must be configured separately.</p> <p>Disable or enable will take effect when you click on Write Time Server Settings to Controller.</p>	Click to select.
Time Server IP Addresses	Primary Secondary	<p>Primary - primary time server's IP address.</p> <p>Secondary - secondary time server address as a backup in case the primary can't be accessed.</p>	Enter addresses. If using one server only, enter the same address as the primary.
Write Time Server Settings to Controller		<p>Writes time server settings (enable or disable) to controller. Status will confirm the completed write. This button does not update the controller time, it just enables the connection. To see the current controller time, go to the Time and Date tab. Important: Network time servers use Greenwich Mean Time. Go to the Time and Date tab and set the time zone for your controller.</p>	Click to write to the controller.
Daylight Saving Mode	Adjust Clock for Daylight Saving Changes	Lets you select one of the three Daylight Saving methods below.	Check box to enable one of the following options.
	Use DSTI Pin on Time and Date Function Block	Controller time will be in Daylight Saving when DSTI pin on the Time and Date function block is ON. Time will be in Standard when pin is OFF.	Click to select.
	One Year	Controller time will change to Daylight Saving, then to Standard, on the dates and times specified for a single year.	Click to select. Enter dates and times. Begin Daylight Saving Time setting must be earlier than Begin Standard Time setting.
	Every Year	Controller time will change to Daylight Saving, then to Standard, on the weekdays and times specified for every year.	Click to select. Enter dates and times. Last will be either 4th or 5th week, whichever is last.

Data Storage Utility

Note: This section does not apply to the 900 Control Station.



opens the **Data Storage Disk Initialization Utility** dialog box.

It is used to initialize ZIP disks offline. (It takes a long time to initialize a disk on the Operator Interface)

Pre-initializing ZIP Diskette

Step	Action
1	Insert the 100MB Zip disk into your PC drive.
2	Select the Data Storage Utility Icon on the Utilities toolbar.
3	The dialog box appears.
4	Select a Drive Letter from the drop-down menu to specify the drive on your PC.
5	Select the number of Trend Groups that the Operator Interface will need from the drop down menu .
6	Click on Pre-initialize to prepare the disk for storage.
7	Exit DSU.
8	Remove disk, insert it into the operator Interface, and initialize it. See Initializing Disk under this section entitled "Data Storage Operation".

Back Up Controller Information

Saves a controller's active configuration as a backup file with .cbk extension. Similar to saving an uploaded configuration except that in addition to the configuration the port settings are saved. Versions 4.1 and up save time settings (time zone, DST, NTS IP addresses).

You are prompted to specify the comm. link settings for the controller to be backed up. Backup files are read-only; to edit you must save as .cde.

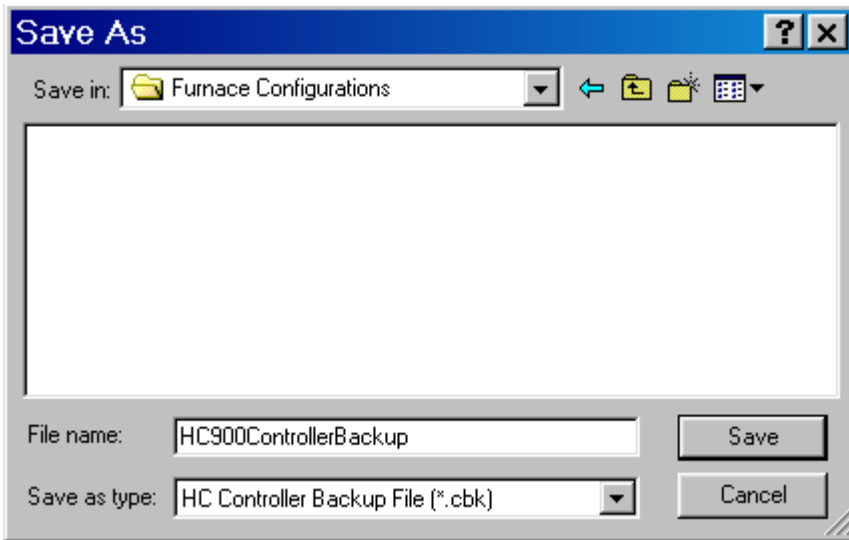

Restore Controller Information

This button is visible for currently open backup files (.cbk).

Choices:

Back Up Controller

Restore Controller – Same as doing a download to controller except port settings are also downloaded.
Controller must be in Program Lock Mode

View Port Settings – Shows all port settings in the backup file.

Serial S1/Serial S2 ports:

Back Up Controller Information

Serial-S1 | Serial-S2 | General Properties | Network-E1 | Network-E2

Honeywell ELN
 Modbus RTU Master
 Modbus RTU Slave

Slave Type: []
Slave Address: [255]
Modbus Slave Double Register Format: [FP B - Big Endian (4,3,2,1)]
Port Enable: [Enabled]

Speed (bps): [38400]
Modbus Parity: [none]
Modbus Stop Bits: [1]

Close

General properties:

The screenshot shows a dialog box titled "Back Up Controller Information" with a close button (X) in the top right corner. The dialog has four tabs: "Serial-S1", "Serial-S2", "General Properties" (which is selected), and "Network-E1" and "Network-E2". The "General Properties" tab contains the following settings:

- Network Name: NETWORK1028
- Controller Name: FURNACE1
- Local Name (alias): ERIC70R1028
- Modbus TCP double register format: FP L - Little Endian (1,2,3,4)
- Email Server - Outgoing Mail (SMTP) server IP Address: 0 . 0 . 0 . 0

A "Close" button is located at the bottom center of the dialog box.

Network E1, Network E2 ports:

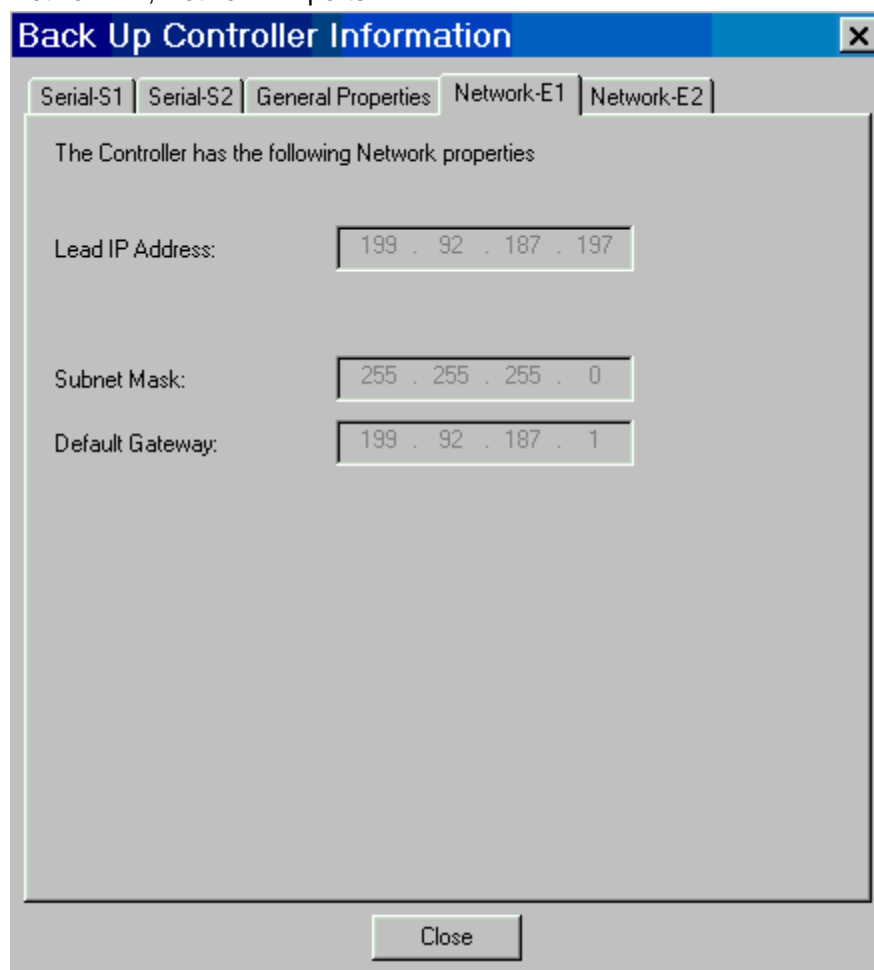

Manually Write Database to Flash

Causes the configuration and user settings of a C70R CPU to be written (saved) to the controller's FLASH memory. User settings include, for example, PID tuning parameters, PP Output calibrations and changes to recipes (setpoint profiles, sequences, schedules). These settings are normally saved in battery-backed RAM, but if there is a power failure and the battery dies, these settings would be lost. By allowing an on-demand write of the database to FLASH, these settings will be retained and available immediately upon power-up.

If using redundant CPUs (C70R) the database is saved to the FLASH of both Lead and Reserve controllers. On-demand write to flash memory is not available for C30 and C50 CPU types.

Diagnostics



has menu selections on a drop-down menu. It lets you select from a list of diagnostic windows for various controller connections.

The controller must be in "Monitor" mode. Select Monitor Mode from the Monitor menu or click on the Monitor mode icon on the Main toolbar.

Controller Diagnostics - displays controller status and diagnostic parameters.

Rack Diagnostics - displays the "Rack Diagnostic Summary" dialog box. Information is for Rack, I/O expansion (except C30 CPU), and Module diagnostics.

Controller Ports Diagnostics - select a port from the drop-down list.

- Serial Port S1
- Serial Port S2
- Network Port
- Expansion Rack Port (except C30 CPU)
- Host Connections
- Peer-to-Peer connections

Modbus Master Port Diagnostics - displays status of the Modbus Master port S1 (RS232) or S2 (RS485), if so configured.

Forced Blocks.- displays a list of Function Blocks, by block ID, that have a forced output pin.

Redundancy – select from the drop-down list:

- Redundancy System
- Redundancy Link
- Lead CPU
- Reserve CPU
- Scanner 2 Link

Calibrate Modules

Overview

The controller I/O modules are factory calibrated to 0.1% accuracy. But, if greater accuracy is required, you can calibrate the **AI and AO modules** using the Process Control Utilities on-line connected to the controller.

You can also calibrate the **Position Proportional Output block**. The calibration of the PPO block is similar to that of the AI and AO except that the calibration values are stored as part of the block's configuration, not on the AI card itself.

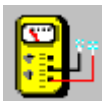

opens the **Calibrate Modules** dialog box.

There are four tabs on the Dialog Box:

AI Channel - see "Calibrate AI Channel".

CJ Temp - see "Calibrate CJ Temp".

AO Channel - see "Calibrate AO Channel".

PPO Block – see "Calibrate Position Proportional Output "

Calibrate AI Channel

The Calibrate AI Channel tab allows you to calibrate the selected AI to ensure that the 0 and 100% values selected during configuration is actually correct.

ATTENTION: *You should not access the Utilities Calibrate Controller Analog I/O display while the OI calibration display is being displayed, or vice versa. Calibration can't be done as long as both displays are shown; user must exit either display to do a calibration.*

To calibrate an AI Channel:

1. Enter a Rack #, Module #, and Channel #.
2. Click on Select Input. The program will then poll the controller to see if the selected AI exists.
3. The Cal 0% button is now available. Connect a reference supply to the input pins of the AI.
The reference supply must have the following characteristics:
T/C, mV, Volts Inputs: 1 microvolt resolution
Ohms, RTD Inputs: 0.1 Ohm resolution
4-20mA inputs: 4 microamp resolution
4. Set the reference supply to the reference value shown. (The reference value is displayed below the Instrument Status section.) Click on "Cal 0%" to calibrate the low end of the AI.
5. The Instrument Status section of the dialog will display the results of the calibration.
6. If the 0% calibration was successful, the 100% button is now available. Set the reference supply to the reference value shown. Click on "Cal 100%" to calibrate the high end of the AI.
7. If the Cal 100% calibration was successful, the Save Cal button is then available. Click on "Save Cal" to save the current set of calibrations for the selected AI.
8. If either calibration fails,
the *Instrument Status* section will display an AI Calibration Failed message - Check connections
The *Reference* section will display a wrong Rack, Module, and channel - reenter Addresses.
9. Click on Close.

Note: Click on "Restore Factory Calibration" button to do same.

NOTE: *Refer to the Calibration section in the HC900 Installation and User Guide for additional Hardware details.*

Calibrate CJ Temp

The Calibrate CJ Temperature tab allows you to ensure the Cold Junction calibration is correct.

To calibrate a CJ Temperature:

1. Enter a Rack #, Module #, and Channel #.
2. At CJ Temperature, enter the actual ambient temperature (measured at the AI pins).
3. Click on Select CJ Input. The program will then poll the controller to see if the selected AI exists. If the AI is found the Cal CJ button will then be available.
4. Click on the Cal CJ button to initiate the calibration. The status of the calibration is displayed in the Instrument Status section of the dialog. If the calibration is successful, the Save Cal button will be available.
5. Click on the Save Cal button to save the current CJ calibration.
6. If the calibration fails, a message will be displayed in the Instrument status section.
7. Click on Close to close dialog.

Note: Click on "Restore Factory Calibration" button to do same.

NOTE: *Refer to the Calibration section in the HC900 Installation and User Guide for additional Hardware details.*

Calibrate AO Channel

The Calibrate AO Channel option allows you to calibrate the selected AO to ensure that the 0 and 100% values selected during configuration are actually correct.

ATTENTION: *You should not access the Utilities Calibrate Controller Analog I/O display while the OI calibration display is being displayed, or vice versa. Calibration can't be done as long as both displays are shown; user must exit either display to do a calibration.*

To calibrate an AO Channel:

1. Enter a Rack #, Module #, and Channel #.
2. Click on Select Output. The program will then poll the controller to see if the selected AO exists.
3. The Cal 0% button is now available. Measure the actual output of the AO at the terminal block with a meter and enter the measurement into 0% Measured. Click on Cal 0% button to calibrate the 0% measurement. The reference value is displayed below the Instrument Status section.
4. The Instrument Status section of the dialog will display the results of the test.
5. If the 0% calibration was successful, the 100% button is now available. Measure the actual output of the AO at the terminal block with a meter and enter the measurement into 100% Measured. Click on Cal 100% button to calibrate the 100% measurement.
6. If the Cal 100% was successful, the Save Cal button is then available. Click on Save Cal in order to save the current set of calibrations for the selected AO.
7. If either of the tests fail, the Instrument Status section will display an AO Calibration Failed message.
8. Click on Close.

Note: Click on "Restore Factory Calibration" button to do same.

NOTE: *Refer to the Calibration section in the HC900 Installation and User Guide for additional Hardware details.*

Restore Factory Calibration

To restore the Factory Calibration:

1. Click on the Restore Factory Calibration button on the dialog box. The Restore Factory Calibration dialog is displayed.
2. Enter the Rack, Module, and Channel number for the desired calibration.
3. Click on Restore to initiate the task. The status of the restore will be displayed in the Instrument Status section of the dialog.
4. Click on Close to close the dialog when the restore is complete.

PPO Block Calibration

Introduction

The Calibrate PPO Block tab allows you to calibrate the selected Position Proportional Output Block to ensure that the 0% and 100% Motor Positions are actually correct and to measure the true motor speed.

The calibration of the PPO Block is similar to that of the AI and AO. However, the calibration values are stored as part of the PPO block's configuration data; not on the AI card itself.

To retain these calibrated values, upload and save the configuration to disk.

The procedure is to move the motor first to its 0% position, wait until the position feedback signal has stabilized, and capture the 0% feedback value.

A similar procedure is done next for the motor's 100% position,

The third step is to measure the true motor speed by moving the motor a fixed period of time, measuring the position feedback delta, and computing a motor speed from this data.

The final step is to save the values in the block's configuration data. All previous calibration values will be overwritten.

Calibration Procedures

There are three methods for calibrating the PPO block. Click on one of the modes shown below for instructions.

AUTO – Controller positions the motor and captures the positions.

SEMI-AUTO – Controller positions the motor and the user captures the positions.

HAND – User positions the motor by hand and captures the positions.

Auto Calibration Procedure

Controller automatically positions the motor and captures the positions.

NOTE: Put the controller in "Offline" or "Program" mode in order to perform calibration.

2. Select the **Utilities tab** at the bottom of the Main Window



3. Under the "Controller Utility Functions", select the **"Calibrate Controller"** icon.



The "Calibrate" dialog box will open.

4. Select the **"PPO Block" tab** at the top of the dialog box.
5. In the "Calibration Block" field, drop-down the list of PPO blocks and **select one**.
6. Under "Calibration Mode", select the **"AUTO" radio button**.
7. Under "Calibration Procedure", press **"Start"**.

Result:

- The "Start" button is disabled and the Status indication at the top of the dialog box will change to indicate that the motor is moving to its 0% position.
The "Feedback Value" area on the dialog will indicate movement and direction of the motor.
The Progress Bar will indicate progress (Time Remaining) for this step.
- The status will change to indicate that the motor is at its 0% position.
The status will change to indicate that the 0% position has been captured.
- The status will change to indicate that the motor is moving to its 100% position and the feedback area will indicate movement and direction of the motor.
The progress bar will indicate progress (Time Remaining) for this step.
- The status will change to indicate that the motor is at its 100% position.
The status will change to indicate that the 100% position has been captured.
- The status will change to indicate that the motor is currently undergoing speed calibration.
The feedback area will indicate movement and direction of the motor.
The progress bar will indicate progress (Time Remaining) for this step.
- The status will change to indicate that the PPO Calibration has been saved.

A message box appears indicating that the calibration is complete.

Three choices will also appear. **Select one.**

Press F2 to Position Motor at 0%

Press F3 to Position Motor at 100%

Press F4 to Leave Motor at Current Position

Semi-Auto Calibration Procedure

Controller automatically positions the motor and the user captures the positions

NOTE: Put the controller in "Offline" or "Program" mode in order to perform calibration.

1. Select the **Utilities tab** at the bottom of the Main Window.

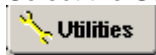

2. Under the "Controller Utility Functions", select the **"Calibrate Controller" icon**



The "Calibrate" dialog box will open.

3. Select the **"PPO Block" tab** at the top of the dialog box.
4. In the "Calibration Block" field, drop-down the list of PPO blocks and **select one**.
5. Under "Calibration Mode", select the **"SEMI-AUTO"** radio button.
6. Under "Calibration Procedure", press **"Start"**.
The "Start" button is disabled and the Status indication at the top of the dialog box will change to indicate that the motor is moving to its 0% position.
The "Feedback Value" area on the dialog will indicate movement and direction of the motor.
The Progress Bar will indicate progress (Time Remaining) for this step.
The status will change to indicate that the motor is at its 0% position.
7. Click the **Cal 0% button**, then the status will change to indicate that the 0% position has been captured.
The status will change to indicate that the motor is moving to its 100% position.
The feedback area will indicate movement and direction of the motor.
The progress bar will indicate progress (Time Remaining) for this step.
The status will change to indicate that the motor is at its 100% position.
8. Click the **Cal 100% button**, then the status will change to indicate that the 100% position has been captured.
9. Click the **Cal Speed button**.
A dialog box will appear warning that the speed calibration will move the motor.
Press "OK" to start or **"Cancel"** to abort.
The status will change to indicate that the motor is currently undergoing speed calibration.
The feedback area will indicate movement and direction of the motor.
The progress bar will indicate progress (Time Remaining) for this step.
10. Click the **Save Cal button**.
A dialog box will appear that confirms the Motor Calibration Values.
Press "OK" to save the values or **"Cancel"** to abort.
The status will change to READY and indicate that the PPO Calibration has been saved.

A message box appears indicating that the calibration is complete.

Three choices will also appear. **Select one.**

Press F2 to Position Motor at 0%

Press F3 to Position Motor at 100%

Press F4 to Leave Motor at Current Position

Hand Calibration Procedure

User positions the motor by hand and captures the positions.

NOTE: Put the controller in "Offline" or "Program" mode in order to perform calibration.

1. Select the **Utilities tab** at the bottom of the Main Window.



2. Under the "Controller Utility Functions", select the **"Calibrate Controller" icon**.



The "Calibrate" dialog box will open.

3. Select the **"PPO Block" tab** at the top of the dialog box.
4. In the "Calibration Block" field, drop-down the list of PPO blocks and **select one**.
5. Under "Calibration Mode", select the **"HAND"** radio button.
6. Under "Calibration Procedure", press **"Start"**.
The "Start" button is disabled and the Cal 0% button is enabled.
7. Move the motor **by hand to its 0% position**.
The feedback area will indicate movement and direction of the motor when it is moving.
8. When ready, click the **Cal 0% button** and the 0% position of the motor is captured as indicated in the status.
9. Move the motor **by hand to its 100% position**.
The feedback area will indicate movement and direction of the motor when it is moving.
10. When ready, click the **Cal 100% button** and the 100% position of the motor is captured as indicated in the status.
11. Click **the Cal Speed button**
A dialog box will appear warning that the speed calibration will move the motor.
Press "OK" to start or **"Cancel"** to abort.
The status will change to indicate that the motor is currently undergoing speed calibration.
The feedback area will indicate movement and direction of the motor.
The progress bar will indicate progress (Time Remaining)
11. Click **the Save Cal button**.
A dialog box will appear that confirms the Motor Calibration Values.
Press "OK" to save the values or **"Cancel"** to abort.
The status will change to READY and indicate that the PPO Calibration has been saved.
A message box appears indicating that the calibration is complete.

This page has been intentionally left blank.

Set Point Programming

Terms and Definitions

Term	Definition
Auxiliary Analog Value	In addition to the main ramp and soak output value, a second analog value is available for each step of the profile. This output is a fixed soak value, which may be used to provide a setpoint value for a secondary control loop in the process. An example would be a ramp and soak temperature program combined with pressure setpoints for each step of the profile.
Cycles	A portion of a profile or the entire program may be repeated up to 100 times or indefinitely as specified in the program Cycles count value.
Engineering Units	You must assign a descriptor consisting of up to 4 keyboard characters for the engineering units that the setpoint value represents. For example, GPM for gallons per minute, NPS for number per second, RPM for revolutions per minute, and DEGF for degrees Fahrenheit.
Guaranteed Hold Soak Limits	Limits High and Low (above and below the Setpoint value) can be configured in selected engineering units. If the PV is outside of configured limits just prior to entering the Soak segment, the soak timer will not be permitted to start. It will start when the PV is within the High and Low limits. Once the soak timer has started and then the PV goes out side of configured limits, the soak timer will halt. It will remain halted until the PV is again within the configured limits. A Guaranteed Hold High or Low limit setting of 0.00 is equal to no limit at all.
Number of Segments	Segments are timed ramp and soak subdivisions of a setpoint program. Consecutive ramps and soaks are allowed. The last segment must be a soak.
Power Loss	A recovery ramp rate value is provided in the event of a power loss while a program is running. The ramp rate value is used to return the process to the last operating setpoint prior to power loss. A power OFF digital input and separate timing block will abort the running program if power loss has been OFF for more than a specified time period.
Program	The term "Program" is used to identify the process for selecting and entering the individual ramp and soak segment data for a Setpoint Program function block (SPP) needed to generate a required setpoint versus time profile (also called a program).
Program Name	During configuration you must assign a name (descriptive reference) consisting of from 1 to 8 letters or numbers without spaces. Thus, a name can be a combination of letters and numbers. Note that lowercase letters are automatically converted to uppercase.
Program Number	This number is assigned when the software or the Operator Interface creates the profile. The program number is assigned in the "Setpoint Profile Pool" and is shown on the "Edit Setpoint Profile" dialog box.
Ramp Segments	<p>A ramp segment is a starting setpoint and the time or rate to reach the setpoint of the following segment.</p> <p>Typically, segment #1 will be a ramp. Ramp time is determined in either:</p> <p style="text-align: center;">TIME*—Hours or Minutes Range = 0.00 hr. to 999.99 hr. / 0.00 min. to 999.99 min.</p> <p style="text-align: center;">OR</p> <p style="text-align: center;">RATE*—EU/MIN or EU/HR Range = 0 to 999.99</p> <p style="text-align: center;">*This selection of time or rate is made when you configure properties.</p> <p>Make this selection before entering any Ramp during Profile Edit.</p> <p>NOTE: When Ramp unit is configured for TIME, entering "0" will imply an immediate step change in setpoint to the next soak.</p>
Running a Profile	Setpoint profiles may be started, held, advanced, jogged to a predefined segment or reset from the operator interface or by digital inputs to the block. Programs may be started from a pre-selected segment number.
Segment	A segment is a ramp or soak function which together make up a Setpoint Profile.

Term	Definition
Segment Events	You can configure 1 to 16 segment events to turn ON or OFF at the beginning of each segment. Segment events are digital switches that provide ON/OFF outputs through an SPEV control block. When a segment event is turned ON, it remains ON until the end of the segment at which time it is turned OFF unless it is configured to turn ON in the next segment. Note that segment events are not interrupted by soak time delays when the process variable is outside the guaranteed soak band. Events turn ON as soon as the previous segment is completed even if the process variable has not reached the soak setpoint. When the program completes, the events are held at current value until the programmer is returned to the ready state.
Setpoint Guarantee	There is a setpoint guarantee function provided that holds the program if a PV exceeds a predefined deviation from setpoint. Selections allow setpoint guarantee to be active for all segments, soak segments only, or for specified segments. Up to 3 Process Variables may be configured as inputs to the block for setpoint guarantee.
Setpoint Value	A setpoint value set for Ramp (starting Setpoint value) and Soak (soak setpoint value)segments
Soak Segments	A soak segment is a combination of soak setpoint (value) and soak duration (time). The last segment must be a Soak. The soak setpoint range value must be within the setpoint high and low range limits in engineering units. SOAK TIME is the duration of the soak and is determined in: TIME* —Hours or Minutes Range = 0.00 hr. to 999.99 hr. / 0.00 min. to 999.99 min. *This selection is made when you configure properties.
Synchronizing Programs	Two setpoint programs operating on the same time base can be synchronized using the Synchronize (SYNC) function block. This block automatically starts the second program when the first program is started and maintains synchronization when either program is place in hold.

What is a Setpoint Program?

A Setpoint Program is really a **setpoint versus time profile** that establishes the setpoint values and how they are to vary with time.

Each setpoint profile consists of segments. Each segment of the profile may be a ramp or a soak except the last step that must be a soak.

In addition to the main ramp and soak output value, a second analog value (Aux. Output) is available for each step of the program. This output is a fixed soak value that may be used to provide a setpoint value for a secondary control loop in the process. An example would be a ramp and soak temperature program combined with pressure setpoints for each step of the program.

Each segment can turn on segment events to provide ON/OFF signals through a Setpoint Program Events (SPEV) control block that is used in conjunction with an SPP block.

Each Profile carries its own unique number and a name for identification. (The names are descriptive references [aliases] and uniqueness is not enforced.) Unique names are recommended to avoid operator confusion).

Using the software, you can set the setpoint values, soak times, guaranteed soak band, ramp rates, and event action for individual setpoint profiles in configuration and access the information through the Setpoint profile display in the operator interface. This means that an operator can adjust individual ramp and soak segment settings during operation, but the general profile configuration, including number and name, is under configuration control.

However, any changes made through the SPP Operate display to a program that is running in an SPP block will **not** be written as changes in the program configuration.

Setpoint Program Configuration Overview

Introduction

Setpoint Program (Profile) configuration provides a quick and easy way to create, edit, and save up to 99 different ramp/soak (setpoint) profiles for the Setpoint Programmer (SPP) control blocks in the configuration. An operator can interact with the configured profiles through the Setpoint Program Operate display at the operator interface or operation can be directed through integral actions connected by Softwiring functions.

Configuration Functions

Basic functions that you will use to configure a Setpoint Profile.

- Create/Edit Setpoint Profile - Under File-New or File-Open you can access the Profile Editor to create or edit a setpoint profile.
- Setpoint Profile Pool - The SP Profile Pool lets you add or delete a profile on a list of configured profiles. Through two menus on the dialog box you can set the properties for each profile and set up or edit the information for each segment that make up a profile.
- Setpoint Profile Properties - Setpoint Profile Properties is information for the profile that is entered on five specific tabs. It includes Text, General, Loop/Jog, and Start/Restart.
- Setpoint Profile Setup (EDIT) - Setpoint Profile Setup or Edit consists of configuring each segment of the profile and assigning the ramps and soaks and associated information (Values, Time, Auxiliary output, Guaranteed Hold, and Events) in the order required to complete your SP program.

This page has been intentionally left blank

Setpoint Schedulers

Setpoint Scheduler Overview

Setpoint Scheduler blocks may be configured for multi-setpoint control. Comprising the suite is a Master block (SPS), Auxiliary Setpoint block (SPSA), Event Decoder block (SPEV), State Switch Block (STSW), and State Flags block (STFL).

The Master block supports ramp or soak outputs operating on a common time base. It accepts one PV for each setpoint. Setpoint guarantee is provided for the master (SPS) block setpoints with a single symmetrical value for each setpoint output.

You can assign a Failsafe value for each setpoint.

The Auxiliary block supports soak only outputs.

The Event block supports event outputs.

A single schedule may include segments and auxiliary block data. The schedules are stored in the controller's memory.

Setpoint Schedules offer the same operating modes and digital controls as setpoint programs.

On-line editing of a running schedule is supported through dedicated operator interface displays

Setpoint Guarantee

Setpoint guarantee is provided for the master block setpoints with a single symmetrical value for each setpoint output. Actions for the guarantee soak may be set on a per segment basis for OFF, high setpoint deviation, low setpoint deviation or both high and low setpoint deviations.

Segments

Each segment of the Setpoint Scheduler allows entry of a next segment recycle location. This function allows unlimited recycle nesting and continuous recycle operation. A jog function allows a single jump to a designated segment number through a digital input to the State Switch block.

Labels

Main Output Labels

Eight character labels and four character engineering units are provided for each Setpoint plus a decimal point selection.

Auxiliary Output Labels

Eight character labels and four character engineering units are provided for each Setpoint plus a decimal point selection

Event Labels

Eight character labels are also provided for the Digital Event block.

Assigning these labels first will aid you in the setpoint schedule configuration process. These labels will appear in the configuration dialog boxes.

Setpoint Schedule Overview

Introduction

Setpoint Schedule configuration provides a quick and easy way to create, edit, and save up to 20 different Setpoint Schedules for the Setpoint Scheduler (SPS) control blocks in the configuration. An operator can interact with the configured schedules through the Setpoint Program Operate display at the operator interface or operation can be directed through integral actions connected by Softwiring functions.

Setpoint Scheduler Display Configuration

ATTENTION

Before you proceed with the Setpoint Schedule assign the appropriate labels for the Setpoint Scheduler displays.

Assigning these labels first will aid you in the schedule configuration process.

See [Setpoint Scheduler Function Block](#) configuration.

These labels will appear in the configuration dialog boxes.

Configuration Functions

Basic functions that you will use to configure a Setpoint Schedule.

- Create/edit Setpoint Schedule - Under File-New or File-Open you can access the Schedule Editor to create or edit a setpoint schedule.
- Setpoint Schedule Pool - The SP Schedule Pool lets you add or delete a schedule on a list of configured schedules. Through this dialog box you will set the properties for each schedule and set up or edit the information for each segment that make up a schedule.
- Setpoint Schedule Properties - Setpoint Schedule Properties is information for the schedule that a Label, a Jog Segment, Time Units, and Guaranteed Hold Limits for each of the eight setpoints.
- Setup/Edit Setpoint Schedule - Setpoint Schedule Setup or Edit consists of configuring each segment of the schedule and assigning starting values for all eight Setpoints of the segment and the Guaranteed Hold Type for each. You can also set up to 16 events for each segment. Time Units, Recycle Segment, and Recycle Counts selections are included on this dialog box.
- You can also assign values to all eight Auxiliary Outputs for each segment by clicking on each "Aux" button on the dialog box.

Sequencers

What is Sequence Control?

The need to control a sequence of operation is a very common control requirement in industrial equipment today. Sequence control can be a very rigid series of inter-related events used to start-up or shut-down a unit process, or it can be a series of timed and process measurement dependent events that are executed to produce a final product.

Sequences can be very simple with only timed or cascaded events that occur regardless of process feedback, or they can be very complex with multiple nested default sequences programmed to occur only if process feedback indicates a need to take alternate actions.

When sequence control is used to produce final product, sequence variations are often required to allow the same equipment to be used to produce multiple types of product. In these applications the sequence is often partitioned into logical units to allow operators and supervisors to monitor the progress of the process using familiar terminology. Heat-up, cool-down, filling, venting, mixing and other similar terms are often used to describe the particular phase the control equipment is executing.

Variations in the product being processed can require changes to the sequence where particular phases are bypassed, duplicated or executed in an alternate manner.

When all of these requirements are combined in a single control specification, developing a suitable control strategy can be a demanding and sophisticated endeavor.

Sequence Configuration Overview

The sequencer function block controls the output statuses of up to 16 digital outputs and one auxiliary analog output. Each combination of outputs represents a state of the sequence such as Heat, Mix, or Cool, for example. The function block supports up to 50 states e.g. PURGE, FILL, HEAT, etc.

The sequence contains up to 64 steps. Each step enables a state, allowing for a state to be designated for several steps.

A pool of 20 sequences, up to 64 steps each, may be stored in controller memory for quick recall and assignment to any of the 4 sequencers.

Each state supports two of digital events as inputs that can designate the end of the associated step.

Time in seconds or minutes, a manual advance, or a digital event can be used to terminate a sequencer step and cause the sequence to advance.

The operational sequence for the steps is retained in a separate sequence file in the memory pool of the controller that may be selected on-demand through a user interface or via a recipe (variables).

Configuration Functions

Basic functions that you will use to configure a Sequence.

Sequence Editor

Create/Edit a Sequence under the File-New or File-Open menus. Accesses the Sequence Editor.

Sequence Pool

When you select "Sequences" from the Recipe menu, the "Sequence Pool" dialog box will be displayed. Through this display, you will add a new sequence or delete an existing one and also enter the properties function and the "Edit Sequence" function to set up each sequence.

Sequence Properties

Sequence Properties is information for the sequencer: Label, Description, a Jog Step, and Time Units.

Sequence Setup (EDIT)

Sequence Setup or Edit consists of configuring each step of the Sequence with a State Number and Name, Time In Step, Time Next Step, Event 1 Next Step, Event 2 Next Step, Advance next step, and an Auxiliary value.

Recipes

Recipe Overview

Multiple meanings of "recipe"

Loop control users apply the word "recipe" differently in different contexts. There is no industry standard for the word's meaning. In a broader sense, a recipe is any collection of data specific to a process setup that can be downloaded into and then run as part of controller's function block configuration. The following are recipe types:

- Recipe (Variables)
- Set Point Profile
- Set Point Schedule
- Sequence

Notice the first recipe type is also called a recipe. The two uses of the word "recipe" can get confusing. In this narrower sense, a recipe is a collection of data—specifically, variables. To distinguish it from the broader meaning HC Designer calls it "**recipe (variables)**".

To one user a recipe is a collection of variables; to another user a recipe is a set point profile; to another user a recipe is a set point schedule; to another it's a sequence. These different uses of the word "recipe" are all ok as long as you understand they are all recipes in the broader sense.

A recipe needs a configuration for context

A recipe by itself is useless; it must be associated with a specific controller configuration to give it context. Therefore when creating or opening a recipe you must specify by name which configuration the recipe applies to. Set Point Profiles are excluded from this requirement.

Recipe type	How linked to configuration
Recipe	Variable tag names
Setpoint Profile	Not linked to configuration
Setpoint Schedule	Event labels
Sequence	State Name, Event Signal #1, Event Signal # 2

Compatibility

It is up to you to understand how your recipes will work with your configurations. For example, when you download a recipe (variables).(rcp) to a controller, the recipe's variables, sequential order and their values might make sense in one controller configuration but not another.

Recipe locations

Once created, a recipe can reside in several places. Be aware that having multiple copies of a recipe can cause mixups. For example, suppose you've created a recipe (any type) called COOKIES. It can reside in the following places.

COOKIES saved as a separate recipe file to disk or floppy. Recipe files can be added to a recipe pool. (See Recipe file types.)

COOKIES in the recipe pool of a configuration saved to disk as a .CDE file.

COOKIES in the recipe pool of a currently open configuration in the software. (See Recipes menu)

COOKIES in the recipe pool of your controller's running configuration. Here it is available to be loaded into the controller's function block configuration.

COOKIES actively loaded and running in your controller's function blocks.

This example applies to all recipe types (recipe (variables), schedules, sequences, profiles).

Recipe file types

After creating a recipe or editing one in the recipe pool, you can save a recipe to disk using the following extensions (assigned automatically).

- Recipe (variables): .RCP
- Set Point Profile: .PRF
- Set Point Schedule: .SCH
- Sequence: .SEQ

When part of a configuration's recipe pool, a recipe is not saved as a separate file but is saved in a "slot" in the pool as part of the configuration (.CDE). Any recipe can be accessed in the configuration's recipe pools and saved as its own recipe file if desired.

Recipes Menu

Accesses all recipe pools. To learn about the different recipe types read Recipe Overview.

Menu Selection	Function
Allocate Recipe Memory	Allocates the controller's memory for the four recipe types. This is the number of recipes that can be stored in the controller's four recipe pools. Recipes in these pools can be loaded and run by Recipe Selection Blocks, Programmers, Schedulers, and Sequencers. As recipe memory usage increases, less memory is available for other parts of your configuration (such as function blocks).
<u>R</u>ecipes (Variables)...	A recipe (variables) is a list of Variables with settings that define the ingredients needed to make a product or run a particular batch. This selection opens the Recipe Pool dialog box and allows viewing, adding, editing, and printing of Recipe details. You can save the selected recipe item to a file; open a recipe file and insert it into the pool; and download the selected recipe item to a controller's recipe pool.
<u>S</u>etpoint <u>P</u>rofiles...	Setpoint Program (Profile) configuration provides a quick and easy way to create, edit, and save different ramp/soak (setpoint) profiles for the Setpoint Programmer (SPP) control blocks in the configuration. This selection opens the Setpoint Profile Pool dialog box and allows viewing, adding, editing, and printing of Setpoint Profile details. You can save the selected SPP item to a file; open a SPP file and insert it into the pool; and download the selected SPP item to a controller's Setpoint Profiles pool.
<u>S</u>etpoint <u>S</u>chedules...	Setpoint Schedule configuration provides a quick and easy way to create, edit, and save different Setpoint Schedules for the Setpoint Scheduler (SPS) control blocks in the configuration. This selection opens the Setpoint Schedule Pool dialog box and allows viewing, adding, editing, and printing of Setpoint Schedules details. You can save the selected SPS item to a file; open a SPS file and insert it into the pool; and download the selected SPS item to a controller's Setpoint Schedule pool.
<u>S</u>equences...	Sequence configuration provides a series of inter-related events used to start-up or shut-down a unit process, or a series of timed and process measurement dependent events that are executed to produce a final product. This selection opens the Sequence Pool dialog box and allows viewing, adding, editing, and printing of Sequence details. You can save the selected SEQ item to a file; open a SEQ file and insert it into the pool; and download the selected SEQ item to a controller's Sequence pool.

Recipe (Variables)

Introduction

Each recipe consists of Variables, and carries its own unique recipe number and name for identification. (The names are descriptive references [aliases] and uniqueness is not enforced. Unique names are recommended to avoid operator confusion). The selected Variables were assigned during the Function Block Diagram Configuration.

It is possible to edit the setting of any recipe Variables through the Recipe Setup display at the operator interface. This means that an operator can adjust individual ingredient amounts in the recipe; but the ingredients (item's Variable Name), the order of the ingredients, and the recipe's number and name are under configuration control.

The recipe variable list is configured using the Designer application. An operator will be able to change individual item values through the Operator Interface.

For automatic loading of a setpoint profile in addition to other variables, a variable representing a profile number may be included in the recipe. This would also apply to a schedule or sequence number.

Recipe Attributes

A recipe is a list of Variables with settings that define the ingredients needed to make a product or run a particular batch. The items represent Analog and/or Digital Points that were assigned in the Function Block Configuration and are identified by their Variable Names. Recipes have these basic attributes:

Recipe Number - A unique number must be assigned for each recipe that is configured. Numbers can be assigned in any sequence with gaps between numbers, but no two recipes can be given the same number.

Recipe Name - A descriptive name must be assigned consisting of letters or numbers with no spaces. Thus, a name can be any combination of letters and numbers without spaces. Note that lowercase letters are automatically converted to uppercase letters.

Recipe Variables - A list of Variables can be compiled for each recipe. A valid Variable and desired setting must be specified for each recipe item.

Adjustable Settings - The setting for an analog point can be any appropriate value from -99999 to 99999, and a digital point can be set in its ON or OFF state. It is possible to edit/change any recipe item/Variable Name setting through the "Edit Recipe" Setup dialog box during configuration.

Recipe (Variables) Configuration

Overview

A recipe is a list of Variables with settings that define the ingredients needed to make a product or run a particular batch. The items represent Analog and/or Digital Points that are assigned in the Function Block Configuration and are identified by their Variable Names.

Configuration Functions

Basic functions that you will use to configure a Recipe:

Recipe Editor

Create/Edit a Recipe under the File-New or File-Open menus. Accesses the Recipe Editor.

Recipe Pool

When you select "Recipes" from the Recipe menu, the "Recipe Pool" dialog box will be displayed. Through this display, you will add a new recipe or delete an existing one and also enter the properties function and the "Edit Recipe" function to set up each recipe.

Recipe Properties

The Recipe Properties is merely a name assigned to the recipe, which will be added to the pool. You can also include a descriptor.

Recipe Setup (EDIT)

Recipe Set Up or Edit consists of selecting Variable names, assigning an analog value or digital state, and adding them to a list of Recipe items.

Using Recipes to Download Setpoint Profiles

Recipes can be given an 16-character name and shown on the Recipe Menu display for user selection (accessed through the Main Menu selections of the Operator Interface).

A Recipe can automatically load a stored profile number for use by a specific Set Point Programmer. To do this connect an Analog Variable to the NPGM pin of the Set Point Programmer block given a name such as PROFNUM (see figure below). This Variable is added to the variable list for a recipe and given a number corresponding to the profile number to be loaded. Upon selection and loading of the recipe at the Operator Interface, the programmer will also load the profile number listed in the recipe. The operation of the programmer to run this profile is from the standard Set Point Programmer display.

As an example, for a selection of a SP Profile number 2, the entries into the Edit Recipe dialog box would be

VARIABLE NAME = PROFNUM VALUE = 2

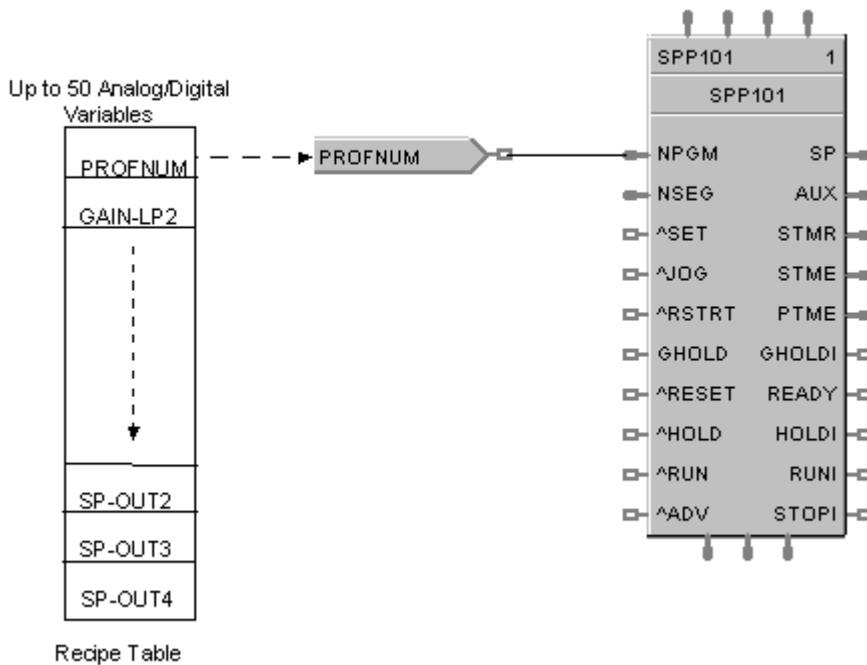

Create/Edit Recipe (Variables) File

Creates/edits a group of variables to be saved as a file (.RCP). File can be downloaded to the recipe pool. A recipe in the pool can later be edited or loaded into the controller's active configuration. The file assumes that the variables are in a certain order in the configuration. Make sure that this order is preserved when loading into a controller's active configuration. Changes to variables via deletions, renaming, or re-directing may affect the recipe content.

Step/Item	Action/Description
Select File, Open.	Lets you choose an .RCP file to edit. After selecting file the Recipe Editor appears.
OR	
Select File, New.	"Choose a new file type" box appears.
Select Recipes tab.	Recipe types appear.
Select Recipes (Variables).	The Recipe Editor appears.
THEN	
Select a Reference Configuration.	A recipe must have a configuration to give it context. Select an open configuration from the pull-down list. If none available, select Open Configuration to open one. The configuration will open. Click back to Recipe Editor and select the reference configuration.
Name and Description	Identify the recipe.
Variable Tag List	Lists all variable tags in the reference configuration. Click on a tag and click Add to add it to the recipe.
Recipe Items	Lists all variables in the recipe.
Name	Name of variable
Value	Value/state of variable. If analog variable, enter a value in the value field. If digital variable, select ON or OFF.
Delete	Deletes selected item from recipe.
Print	Prints the recipe
Save	Saves the recipe as .RCP file.
Download	Downloads recipe to the controller's recipe pool where it can be edited or loaded into the controller's active configuration.

Recipe Pool

Introduction

This is the recipe (variables) pool. The Recipe Pool lets you add or delete a Recipe on a list of configured Recipes and also enter the "Properties" function and the "Edit Recipe " function to set up each recipe.

Configuration

When you select "Recipes (Variables)" from the Recipes menu, the "Recipe Pool" dialog box will be displayed. From left to right the icons are:



ADD a Recipe:

Put cursor on an empty pool line and select the **NEW** Icon. The "Recipe Properties" dialog box will open.

EDIT the Properties of an Existing Profile:

Select the **Worksheet Properties** Icon. The "Recipe properties" dialog box will open.

EDIT a Recipe:

Select the **Edit Recipe** Icon. The "Edit Recipe" dialog box will appear.

COPY and PASTE:

Select a recipe from the pool window, then select the **Copy** Icon. Select another location in the pool window, then select the **Paste** Icon. The copied recipe will be inserted into the location selected.

DELETE a Recipe:

Click on a recipe name and then click on the **Delete** icon.

PRINT a Recipe:

Click on a recipe name and then select the **Print** icon. The "Print" dialog box will appear.

Select OK.

A recipe report will be printed with all the information entered on the "Recipe Properties" dialog box. [Variable, Description, Value or State]

SAVE a Recipe:

To save a recipe as a .rcp file, click on a recipe name and then select the Save icon. The "Save As" dialog box will appear.

OPEN a Recipe:

To open a previously saved .rcp file and insert it into the pool, click on the Open icon.

DOWNLOAD a Recipe:

To download a recipe to the controller's recipe pool, click on the Download icon.

Setup/Edit a Recipe in Pool

The "Edit Recipes" dialog box lets you set up or edit a recipe listed in the "Recipe Pool."

Make sure you have clicked on "Properties " and have given that specific recipe a name and description. See RECIPE POOL before proceeding.

Procedure

Click on a recipe name in the active field and select "Recipe" or double click on the recipe name. The "Edit Recipe" dialog box will appear.

To ADD Variable to a Recipe:

Select a variable and click on ADD. A variable number will appear under "Recipe Items".

To DELETE a Variable from a Recipe:

Select a **variable number** from the "Recipe Items" field, then click "Delete".

To SET UP a Recipe Item

From the "Recipe Items" list, select a variable name from the list of recipe items.

If it is an **analog variable**, enter a **value** in the value field.

If it is a **digital variable**, select **ON or OFF**, from the drop-down menu in the Value field, as a digital state for the variable.

Repeat this procedure for each **recipe variable** desired for the recipe you are configuring.

Click "OK". The length of the Recipe (number of variables) will appear in the "Recipe Pool".

Click "CLOSE" on the "Recipe Pool" dialog box to complete the configuration.

Recipe Properties

The Recipe Properties dialog box contains fields for you to enter:

- a recipe name you want assigned to the recipe, which will be added to the pool.
- a descriptor of 16 characters.

Setpoint Profiles

Create/Edit Setpoint Profile File

Creates/edits a setpoint profile be saved as a file (.PRF). File can be downloaded to the setpoint profile pool. A profile in the pool can be edited or loaded into the controller's active configuration.

Step/Item	Action/Description
Select File, Open.	Lets you choose a .PRF file to edit. After selecting file the Profile Editor appears.
OR	
Select File, New.	"Choose a new file type" box appears.
Select Recipes tab.	Recipe types appear.
Select Setpoint Profile	The Profile Editor appears.
THEN	
Name and Description	Identify the profile.
Properties	This function lets you set the properties for the profile. The information configured here will appear in the Edit SP Profile dialog box.
Ramp Type Eng. Units Time Units Aux. Out Units Guar. Hold Type Guar. Hold High Guar. Hold Low	Properties of the profile. You can change these under Properties.
Add	Adds a step.
Insert	Inserts a step.
Delete	Deletes selected step.
Type	Ramp or Soak. A ramp segment is a starting setpoint and the time or rate to reach the setpoint of the following segment. Typically, segment #1 will be a ramp.
SP Value	Setpoint value set for Ramp (starting Setpoint value) and Soak (soak setpoint value).
Time/Rate	Ramp time is determined in either: TIME*-Hours or Minutes Range = 0.00 hr. to 999.99 hr. / 0.00 min. to 999.99 min. OR RATE*-EU/MIN or EU/HR Range = 0 to 999.99 *This selection of time or rate is made when you configure properties. Make this selection before entering any Ramp. NOTE: When Ramp unit is configured for TIME, entering "0" will imply an immediate step change in setpoint to the next soak.

Step/Item	Action/Description
Aux. Out	In addition to the main ramp and soak output value, a second analog value is available for each step of the profile. This output is a fixed soak value, which may be used to provide a setpoint value for a secondary control loop in the process. An example would be a ramp and soak temperature program combined with pressure setpoints for each step of the profile.
Guar. Hold	OFF or ON. Choose ON to hold the program if a process variable exceeds a predefined deviation from setpoint.
Events	You can configure 1 to 16 segment events to turn ON or OFF at the beginning of each segment. Segment events are digital switches that provide ON/OFF outputs through an SPEV control block. When a segment event is turned ON, it remains ON until the end of the segment at which time it is turned OFF unless it is configured to turn ON in the next segment. Note that segment events are not interrupted by soak time delays when the process variable is outside the guaranteed soak band. Events turn ON as soon as the previous segment is completed even if the process variable has not reached the soak setpoint. When the program completes, the events are held at current value until the programmer is returned to the ready state.
Print	Prints the profile.
Save	Saves the profile as .PRF file.
Download	Downloads profile to the controller's Setpoint Profile Pool where it can be edited or loaded into the controller's active configuration.

Setpoint Profile Properties

Introduction

This function lets you set the properties for the program selected in the Setpoint Profile Pool. Appears when creating a new profile or editing one in the setpoint profile pool.

Parameters

Enter the properties information in the appropriate fields in the dialog box, then click "OK".

Parameter	Parameter Description	Entry Information
TEXT		
Label	Profile Name	8 characters
Descriptor	Description of Profile	16 characters
Primary Output Label	Primary Output Descriptor Name.	8 characters
Primary Output Engineering Units	Primary Output Engineering Units descriptor	4 characters
Auxiliary Output Label	Auxiliary Output Descriptor name	8 characters
Auxiliary Output Engineering Units	Auxiliary Output Engineering Units descriptor	Auxiliary Output Engineering Units descriptor
GENERAL		
Ramp Type		
<i>Rate</i>	Each ramp segment's time specifies the RATE at which that profile's output will reach the next segment.	Click on Radio button
<i>Time</i>	Each ramp segment's time is the TIME allotted to the profile's output to reach the next segment's value in hours or minutes.	Click on Radio button
Guaranteed Hold Type		
<i>None</i>	No guaranteed hold if a PV deviates a specified amount above or below the profile output.	Click on Radio button
<i>Per Segment</i>	Lets you select specific segments for guaranteed soak where you set up the profile ramps and soaks.	Click on Radio button
<i>All Soaks</i>	All soaks will have a guaranteed soak.	Click on Radio button

Setpoint Profiles
Setpoint Profile Properties

<i>All Segments</i>	All segments will have a guaranteed soak	Click on Radio button
Time Units <i>Hours</i> <i>Minutes</i>	This selection assigns the time units of all segments in HOURS. This selection assigns the time units of all segments in MINUTES.	Click on Radio button Click on Radio button
Guaranteed Hold High	A Number in Engineering Units above the setpoint outside of which the timer halts	Enter a value
Guaranteed Hold High	Enter a Number in Engineering Units below the setpoint outside of which the timer halts.	Enter a value
LOOP/JOG		
Jog Segment	Segment number jog will go to.	Enter a value
Loop <i>Start Segment</i> <i>End Segment</i> <i>Cycles</i>	This designates the number of the first segment of the loop. This designates the number of the last segment of the loop. The last segment of a program must be a soak segment. Last segment of a loop can be a ramp or soak. This number lets the program repeat (loop) a specified number of time from beginning to end. An entry of 0 will cause an indefinite loop.	Enter a value from 1 to 49 Enter a value from 2 to 50 Enter a value from 0 to 100
START/RESTART Restart Rate	The Restart Rate value is used to return the process to the last operating setpoint prior to power loss when restart input is connected to power off timing block.	Enter a value in Engineering Units

Click on the tab to access the properties for that tab.

Enter the information required for each tab then click "OK".

Click on the profile name in the Setpoint Profile Pool and select the Edit Segments Icon (3rd from left) from the Toolbar on the dialog box

Setpoint Schedules

Create/Edit Setpoint Schedule file

Creates/edits a setpoint schedule be saved as a file (.SCH). File can be downloaded to the setpoint schedule pool. A schedule in the pool can be edited or loaded into the controller's active configuration.

Step/Item	Action/Description
Select File, Open.	Lets you choose a .SCH file to edit. After selecting file the Schedule Editor appears.
OR	
Select File, New.	"Choose a new file type" box appears.
Select Recipes tab.	Recipe types appear.
Select Setpoint Schedule.	The Schedule Editor appears.
THEN	
Select a Reference Configuration.	A schedule must have a configuration to give it context. Select an open configuration from the pull-down list. If none available, select Open Configuration to open one. The configuration will open. Click back to Schedule Editor and select the reference configuration.
Name and Description	Identify the schedule.
Properties	Sets properties for the schedule, such as time units and guaranteed hold limits.
Time	Length of time for the segment.
SP1-SP8	Setpoint values. For ramp segments these are the starting values.
Events 1-16	Segment events are digital switches that provide ON/OFF output through an SPS function block. When a segment event is turned ON, it remains on until the end of the segment at which time it is turned OFF unless it is configured to turn ON in the next segment. Select from the drop down menu which events you want to turn ON or OFF at the beginning of each segment.
Aux1-Aux8	The auxiliary block supports up to 8 soak only outputs. You can assign values to all eight Auxiliary Outputs for each segment.
GHold1-GHold8	Setpoint guarantee is provided for the master block setpoints with a single symmetrical value for each setpoint output. Actions for the guarantee soak may be set on a per segment basis for OFF, HIGH setpoint deviation, LOW setpoint deviation or both HIGH and LOW setpoint deviations. Click on an active field and select a GHOLD Type from Drop-down menu: OFF - No Guaranteed Hold HIGH setpoint deviation - The schedule will hold if a PV deviates above the Setpoint value set. LOW setpoint deviation - The schedule will hold if a PV deviates below the Setpoint value set on the "Setpoint Schedule Properties" dialog box. HIGH and LOW setpoint deviations - The schedule will hold if a PV deviates above or below the Setpoint value set on the "Setpoint Schedule Properties" dialog box.
Recycle Segment	The segment number at which a recycle will start. Enter a value 0 to 50
Recycle Count	This number lets the schedule repeat (loop) a specified number of times. Enter a value 0-999 or 0 for infinite.

Step/Item	Action/Description
Delete	Deletes selected item from schedule.
Print	Prints the schedule.
Save	Saves the schedule as .SCH file.
Download	Downloads schedule to the controller's schedule pool where it can be edited or loaded into the controller's active configuration.

Setpoint Schedule Pool

Introduction

The SP Schedule Pool lets you add or delete a schedule on a list of configured schedules. Through this dialog box you will set the properties for each schedule and then set up or edit the information for each segment that make up a schedule.

Configuration

When you select "Setpoint Schedules" from the Recipe menu, the "Setpoint Schedule Pool" dialog box will be displayed. Through this display, you will add a new schedule or delete an existing one and also enter the set properties function and the "Edit Schedule" function to set up each schedule.

From left to right the icons are:



To ADD a Schedule:

Select the **NEW** Icon. The "Setpoint Schedule Properties" dialog box will open.

To EDIT the *Properties of an Existing Schedule*:

Select the **Worksheet Properties** Icon. The "Setpoint Schedule Properties" dialog box will open.

To EDIT a Schedule:

Select the **Edit Segments** Icon. The "Edit Setpoint Schedule" dialog box will appear.

COPY and PASTE:

Select a schedule from the pool window, then select the **Copy** Icon. Select another location in the pool window, then select the **Paste** Icon. The copied schedule will be inserted into the location selected.

To DELETE a Schedule:

Click on a schedule name and then click on the Delete icon.

PRINT a Schedule:

Click on a schedule name and select the **Print** icon. The "Print" dialog box will appear.

Select OK.

A profile report will be printed with all the information entered on the tabs of the "Setpoint Schedule Properties" dialog box.

SAVE a Schedule:

To save a Schedule as a .sch file, click on a recipe name and then select the Save icon. The "Save As" dialog box will appear.

OPEN a Schedule:

To open a previously saved .sch file and insert it into the pool, click on the Open icon.

DOWNLOAD a Schedule:

To download a Schedule to the controller's Schedule pool, click on the Download icon.

Setup/Edit Setpoint Schedule in Pool

Introduction

The “Edit Schedule” dialog box lets you set up or edit a schedule from the schedules listed in the [“Setpoint Schedule Pool.”](#)

Make sure you have clicked on [“Properties”](#) and have configured the properties for that specific Schedule.

Edit a Schedule

Click on a schedule name in the active field and select the **Edit Segments** Icon (3rd from left) from the **Toolbar** on the dialog box or double click on the schedule name.

The **“Edit Schedule Segments”** dialog box will appear with the selected Schedule indicated on the top banner. The Designer presents multiple segments at a time to view and edit.

To ADD a Segment

Click on ADD on the dialog box. A new Segment number will appear at the bottom of the segment list.

To DELETE a Segment

Click on a segment number in the field and click “Delete” on the dialog box. The segment will be deleted and all the segment numbers following the deletion will be changed.

To EDIT a Segment

Each segment contains the following Segment attributes: (click on field for drop down menu to appear for some selections)

Parameter	Parameter Description	Entry Information
Time	Length of time for the segment Time Units were selected in the “Setpoint Schedule Function Block Properties” Dialog Box	Value in Minutes or Hours, whichever has been selected.
Setpoint Values	Setpoint 1 through Setpoint 8	Enter a starting setpoint value in each active field
Ghold Type [Ghold1 thru Ghold8]	Setpoint guarantee is provided for the master block setpoints with a single symmetrical value for each setpoint output. Actions for the guarantee soak may be set on a per segment basis for OFF, HIGH setpoint deviation, LOW setpoint deviation or both HIGH and LOW setpoint deviations.	Click on an active field and select a GHOLD Type from Drop-down menu
	OFF - No Guaranteed Hold	
	HIGH setpoint deviation The schedule will hold if a PV deviates above the Setpoint value set.	
	LOW setpoint deviation The schedule will hold if a PV deviates below the Setpoint value set on the “Setpoint Schedule Properties” dialog box.	
	HIGH and LOW setpoint deviations The schedule will hold if a PV deviates above or below the Setpoint value set on the “Setpoint Schedule Properties” dialog box.	

Setpoint Schedules
 Setup/Edit Setpoint Schedule in Pool

Parameter	Parameter Description	Entry Information
Auxiliary Outputs [Aux1 thru Aux8]	The auxiliary block supports up to 8 soak only outputs. You can assign values to all eight Auxiliary Outputs for each segment.	Enter values for all Auxiliary Outputs in the appropriate fields.
Recycle Segment	The segment number at which a recycle will start	Enter a value 0 to 50
Recycle Count	This number lets the schedule repeat (loop) a specified number of times.	Enter a value 0-999 or 0 for infinite
Events [Events 1 thru 16]	Segment events are digital switches that provide ON/OFF output through an <u>SPS function block</u> . When a segment event is turned ON, it remains on until the end of the segment at which time it is turned OFF unless it is configured to turn ON in the next segment.	Select, from the drop down menu, which events you want to turn ON or OFF at the beginning of each segment. Click on the box for each segment. A zero will change to 1 in the selected event position

Setpoint Schedule Properties

Introduction

This function lets you set the properties for the schedule selected in the Setpoint Schedule Pool. If you are adding a schedule, this dialog box will automatically appear. It will also appear if you select the **Worksheet Properties** Icon (2nd from left) from the **Toolbar** on the dialog box. The information configured here will appear in the “Edit Schedule Segment” dialog box.

Configuration

Refer to the table below and enter the properties information in the appropriate fields in the dialog box, then click “OK”. You will return to the “Setpoint Schedule Pool” dialog box.

Parameter	Parameter Description	Entry Information
General		
<i>Label</i>	Schedule Name	6 characters
<i>Descriptor</i>	Description of schedule	16 characters
<i>Jog Seg</i>	Logic input (JOG) on state switch block will cause the schedule to jump to the start of the segment designated then continue.	Segment number jog will go to
Time Units	This selection assigns the time units (hours <i>or</i> minutes) for all segments.	
<i>Hours</i>	Time unit in Hours	Click on Radio button
<i>Minutes</i>	Time unit in Minutes	Click on Radio button
Guaranteed Hold Limit	The schedule will hold if a PV deviates above or below (or both) the Setpoint value set here. Select Guaranteed Hold Type on the “Setpoint Edit Schedule” dialog box.	Enter a setpoint value

Sequences

Create/Edit Sequence File

Creates/edits a sequence be saved as a file (.SEQ). File can be downloaded to the sequence pool. A sequence in the pool can be edited or loaded into the controller's active configuration.

Step/Item	Action/Description
Select File, Open.	Lets you choose a .SEQ file to edit. After selecting file the Sequence Editor appears.
OR	
Select File, New.	"Choose a new file type" box appears.
Select Recipes tab.	Recipe types appear.
Select Sequence.	The Sequence Editor appears.
THEN	
Select a Reference Configuration.	A sequence must have a configuration to give it context. Select an open configuration from the pull-down list. If none available, select Open Configuration to open one. The configuration will open. Click back to Sequence Editor and select the reference configuration.
Name and Description	Identify the sequence.
Properties	Sets properties for the sequence, such as jog step and time units.
Add	Adds a step to the sequence.
Time	Length of time for the segment.
SP1-SP8	Setpoint values at the start of the segment.
State	State number for each step of the sequence. A state may be selected multiple times in the sequence. Since time is an attribute of the sequence, the state may be activated for a different time period each time it is selected. (The order does not have to be sequential). Enter a State Number in each active field. States are numbered from 1 to 50.
State name	Name of current state. Enter a state name (12 character max.) Examples: Heating, Cooling, Mixing.
Time in Step	Time duration value for each step of the sequence. Time units can be changed under Properties.
Time in Next Step	Designates the step the sequence will advance to when the time expires. It can be any step in the sequence, including steps that have been previously executed. Enter 0 to stop the sequence after current step expires and to hold the outputs.
Event Signal #1	Click on the Event Signal #1 field and from the drop-down menu, select the event you want signal #1 to represent.
Event 1 Next Step	Each state of the sequence can also be configured to accept two different events to terminate the step. Whichever occurs first—an Off-to-On (rising edge) transition of either event signal OR elapsed step time—will cause the sequence to advance to the appropriate next step. Enter a value for Event 1 Next Step.
Event Signal #2	Click on the Event Signal #2 field and from the drop-down menu, select the event you want signal #2 to represent.

Step/Item	Action/Description
Event 2 Next Step	Each state of the sequence can also be configured to accept two different events to terminate the step. Whichever occurs first—an Off-to-On (rising edge) transition of either event signal OR elapsed step time—will cause the sequence to advance to the appropriate next step. Enter a value for Event 2 Next Step.
Advance Next Step	Allows you to select an appropriate action for the manual advance OI action or function block digital advance input. Enter a value.
Aux. Value	Enter an analog output value associated with each state.
Delete	Deletes selected step from sequence.
Print	Prints the sequence.
Save	Saves the sequence as .SEQ file.
Download	Downloads sequence to the controller's schedule pool where it can be edited or loaded into the controller's active configuration.

Sequence Pool

Introduction

The Sequence Pool lets you add or delete a Sequence on a list of configured Sequences and also enter the "Properties" function and the "Edit Sequence " function to set up each Sequence.

Configuration

When you **select "Sequences" from the Recipes menu**, the "Sequence Pool" dialog box will be displayed. From left to right the icons are:



ADD a Sequence:

Select the **NEW** Icon. The "Sequence Properties" dialog box will open.

EDIT the Properties of an Existing Sequence:

Select the **Worksheet Properties** Icon. The "Sequence Properties" dialog box will open.

EDIT a Sequence:

Select the **Edit Sequence** Icon. The "Setup/Edit Sequences" dialog box will appear.

COPY and PASTE:

Select a recipe from the pool window, then select the **Copy** Icon. Select another location in the pool window, then select the **Paste** Icon. The copied sequence will be inserted into the location selected.

DELETE a Sequence:

Click on a sequence name and then click on the **Delete** icon.

PRINT a Sequence:

Click on a sequence name and then select the **Print** icon. The "Print" dialog box will appear. Select OK.

A sequence report will be printed with all the information entered on the "Sequence Properties" dialog box. [Label, Description, Jog Step, and Time Units in Hours or Minutes]

SAVE a Sequence:

To save a sequence as an .seq file, click on a recipe name and then select the Save icon. The "Save As" dialog box will appear.

OPEN a Sequence:

To open a previously saved .seq file and insert it into the pool, click on the Open icon.

DOWNLOAD a Sequence:

To download a sequence to the controller's sequence pool, click on the Download icon.

Setup/Edit Sequence in Pool

Introduction

The "Edit Sequence" dialog box lets you set up or edit a sequence from the sequences listed in the "Sequence Pool" dialog box.

Make sure you have clicked on "Edit Properties" toolbar icon and have configured the properties for that specific Sequence.

Edit a Sequence

Click on a Sequence name in the active field and select the **Edit Item** Icon (3rd from left) from the **Toolbar** on the dialog box or double click on the Sequence name.

The "**Edit Sequence**" dialog box will appear with the selected Sequence indicated on the top banner. Several Steps are shown for viewing and editing.

To ADD a Step

Click on ADD on the dialog box. A new Step number will appear at the bottom of the Step list.

To DELETE a Step

Click on a Step number in the field and click "Delete" on the dialog box. The Step will be deleted and all the step numbers following the deletion will be changed.

To EDIT a Step

Each step contains the following Step attributes:

Parameter	Parameter Description	Entry Information
State Number	State number for each step of the sequence. A state may be selected multiple times in the sequence. Since time is an attribute of the sequence, the state may be activated for a different time period each time it is selected. (The order does not have to be sequential)	Enter a State Number in each active field. States are numbered from 1 to 50
State Name	Name of current state	N/A
Time in Step	Time duration value for each step of the sequence. Time Units are selected on the Sequence Properties dialog box	Enter values for all Steps in the appropriate fields.
Time Next Step	Designates the step the sequence will advance to when the time expires. It can be any step in the sequence, including steps that have been previously executed.	Enter a number for the next step when time expires on current step. Enter 0 to stop the sequence after current step expires and to hold the outputs.
Event Signal #1	The event signal is a digital signal defined in the sequencer block. When Event Signal #1 signal transitions from FALSE to TRUE the sequence will jump to the step defined in Event 1 Next Step.	N/A
Event 1 Next Step	An off-to-on (rising edge) transition of Event Signal #1 will cause the sequence to advance to the step specified here.	Enter a value for Event 1 Next Step.
Event Signal #2	The event signal is a digital signal defined in the sequencer block. When Event Signal #2 signal transitions from FALSE to TRUE the sequence will jump to the step defined in Event 2 Next Step.	N/A
Event 2 Next Step	An off-to-on (rising edge) transition of Event Signal #2 will cause the sequence to advance to the step specified here.	Enter a value for Event 2 Next Step.
Advance Next Step	Allows you to select an appropriate action for the manual advance OI action or function block digital advance input	Enter an "Advance Next Step" value.
Aux Value	Enter an analog output value associated with each state.	Enter an analog output value.

Sequence Properties

Introduction

This function lets you set the properties for the sequence selected in the Sequence Pool. If you are adding a Sequence, this dialog box will automatically appear. It will also appear if you select the **Worksheet Properties** Icon (2nd from left) from the **Toolbar** on the dialog box. The information configured here will appear in the "Edit Sequence" dialog box.

Configuration

Refer to the table below and enter the properties information in the appropriate fields in the dialog box, then click "OK" to return to the "Sequence Pool" dialog box.

Parameter	Parameter Description	Entry Information
General		
Label	Sequence Name	6 characters
Descriptor	Description of Sequence	16 characters
Jog Step	Logic input (JOG) on state switch block will cause the Sequencer to jump to the start of the step designated then continue.	Step number jog will go to
Time Units	This selection assigns the time units (hours or minutes) for all Steps.	
Hours	Time unit in Hours	Click on Radio button
Minutes	Time unit in Minutes	Click on Radio button

On-Line Monitoring

Overview

Designer Monitoring provides the following:

- Multiple, concurrent function block Monitor Windows
 - You can open as many Function Block monitor windows as you want until you run out of physical resources on the PC
 - You can open Function Block monitor windows concurrently for Function Blocks on *different* Function Block Diagram Worksheets
 - Function Block monitor window can be resized to better suit concurrent windows
- Provides a Watch Window to view groups of related data such as I/O and Signal Tags
- Allows Monitoring to cross all FBD worksheet boundaries
 - There are no boundaries
 - You can call up Function Block monitor windows from any or all FBD worksheets concurrently
 - The Watch Window implicitly crosses all worksheets
 - All other diagnostic windows can also be open concurrently

Access

Select "Monitor Mode" from the "Monitor" menu or select the "Monitor" icon from the Main



Toolbar.

You can specify the monitor update rate that determines how often data is collected from the controller during monitoring. This update rate can be set to either 1/4 second, 1/2 second, 1 second, or 5 seconds.

See "Monitor Toolbar" for the available Monitoring and Diagnostic Windows.

See "Visual Indicators for Monitor Mode" for on-line monitoring indicators.

Enter Monitor Mode

Select "Monitor Mode" from the "Monitor" menu or select the "Monitor" icon from the Main Toolbar.



While in monitor mode, edits to the configuration cannot be made.

Procedure

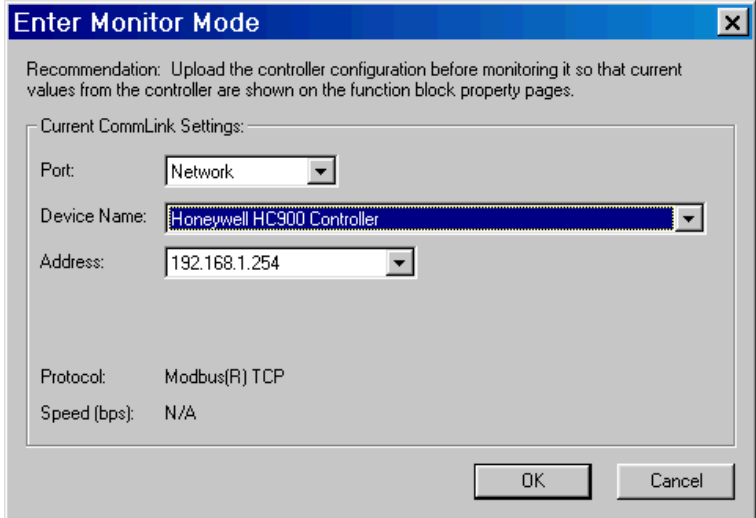
1	Selecting this menu item opens the "Enter Monitor Mode" dialog box  The screenshot shows a dialog box titled "Enter Monitor Mode" with a close button (X) in the top right corner. Below the title bar, there is a recommendation: "Recommendation: Upload the controller configuration before monitoring it so that current values from the controller are shown on the function block property pages." Underneath, a section titled "Current CommLink Settings:" contains several fields: "Port:" with a dropdown menu set to "Network"; "Device Name:" with a dropdown menu set to "Honeywell HC900 Controller"; "Address:" with a dropdown menu set to "192.168.1.254"; "Protocol:" set to "Modbus(R) TCP"; and "Speed (bps):" set to "N/A". At the bottom of the dialog box are "OK" and "Cancel" buttons. <p>Recommendation: Upload the controller configuration before monitoring it so that current values from the controller are shown on the function block property pages.</p> <p>Current CommLink Settings:</p> <p>Port: Network</p> <p>Device Name: Honeywell HC900 Controller</p> <p>Address: 192.168.1.254</p> <p>Protocol: Modbus(R) TCP</p> <p>Speed (bps): N/A</p> <p>OK Cancel</p>
2	Select the controller to monitor using the Port and Address fields on this dialog. The dialog box also indicates the Protocol and Baud rate for the selected controller.
3	Click the OK button on this dialog to enter monitor mode for this configuration.
4	The background of the function block diagram worksheet changes to yellow and the cursor includes the Monitor icon [Eye] with the arrow. See " Visual Indicators for Monitor Mode ".
5	The Monitor Toolbar will appear, whose buttons you can use to toggle (show or hide) the various monitor windows. These windows can also be toggled using menu items on the Monitor menu.
6	When exiting monitor mode, any monitor windows still open will be closed and will be re-opened at their same positions when monitor mode is re-entered for this configuration.

Visual Indicators for Monitor Mode

When "Monitor Mode" is selected there are several indications that the configuration is in Monitor Mode.

1. The "Connected" indicator on the Status Bar will blink to show that the controller, whose name appears next to it, is being monitored.
2. The cursor changes to include the Monitor icon [Eye] along with the arrow.
3. The word <Monitoring> appears in the configuration Title Bar at the top of the diagram.
4. The background color of the Function Block Diagram changes to YELLOW.

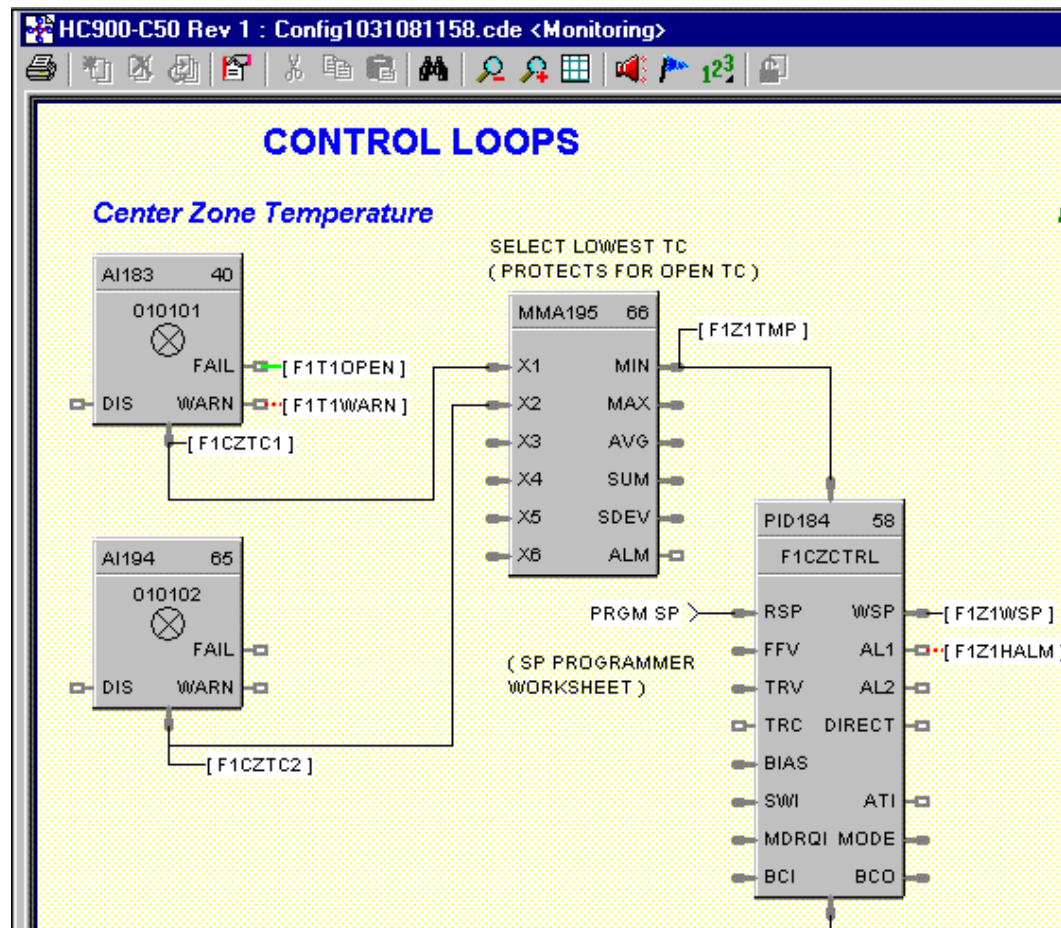

Monitor Update Rate

Introduction

You can specify the monitor update rate that determines how often data is collected from the controller during monitoring. This update rate can be set to either 1/4 second, 1/2 second, 1 second, or 5 seconds.

This option is **allowed only during edit mode**, not while you are monitoring the controller. The default monitor update rate is 1 second and this update rate is remembered between sessions of the software.

If you want to monitor from a relatively slow computer set the monitor update rate to a slow setting.

Procedure

Select "Set Update Rate" from the "Monitor" menu on the Main Drop-down menus.

Select an Update Rate from the Sub-menu:





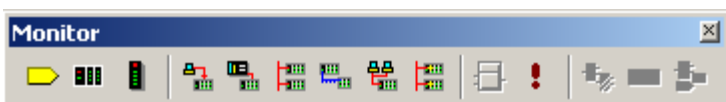

- 1/4 Second
- 1/2 Second
- 1 Second, or
- 5 seconds





Monitor Toolbar



Click on ICON to open a dialog box. More than one dialog box can be open at a time.

The Monitor Toolbar toggles monitor windows for the following:

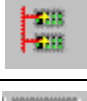
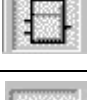
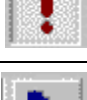
ICON	Function	Window Comments
	Watch Summary	Toggles the Watch Summary Window that lets you view groups of related data such as I/O and Signal Tags.
	Controller Diagnostics	Toggles the Controller Diagnostics Window that lets you view the controller parameters and values.
	Rack Diagnostics	Toggles the I/O Rack Diagnostics window that lets you view the Rack Diagnostics, Expansion I/O Comm Diagnostics(except C30 CPU), and the I/O Module diagnostics.
	Serial S1 Port Diagnostics	Opens the Serial Port S1 (RS232 Default) Configuration Port Diagnostics window that lets you view the parameters and values of the S1 port (default R2-232) on the controller.
	Serial S2 Port Diagnostics	Toggles the Serial Port S2 (RS485 default) OI Port Diagnostics window that lets you view the S2 port (default RS485 Operator Interface) parameters and values.
	Network Port Diagnostics	Toggles the Network Port Diagnostics window that lets you view the network port parameters and values.

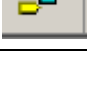
ICON	Function	Window Comments
	Expansion I/O Comm Diagnostics (except C30 CPU)	Toggles the Expansion I/O Comm Diagnostics window that lets you view the expansion port parameters and values.
	Host Connections Diagnostics	Toggles the Host Connections window that lets you view the host connections parameters and values.
	Peer-to-Peer Diagnostics	Toggles the Peer-to-Peer Connections Diagnostics window that lets you view the Peer-to-Peer parameters and values.
	Function Block Monitor	Toggles the Monitor Function Block window that lets you monitor key parameters of the selected Function Block.
	Forced Blocks Window	Toggles the Forced Block Summary Window Window that lets you see all the function blocks that have forced outputs.
	All Function Block Windows	Lets you toggle the function block windows that are open - Display or Hide
	All Pins	Lets you toggle (display/hide) monitoring values (numeric or On/Off state) at all input and output pins that are shown.
	All Monitor Windows	Lets you toggle the Monitor windows that are open - Display or Hide.

How Do I Start Monitoring

Procedure

Either upload the configuration from the controller to your PC or Open the file from disk that matches what's in the controller. Designer will inform you if the file you opened is not currently loaded in the controller. In this case, limited monitoring capabilities will be available. For example, you won't be able to monitor function blocks or bring up the Watch Summary Window.

Press the MONITOR button on the main toolbar.



The "Enter Monitor Mode" dialog box will open.

Note: *While in monitor mode, you won't be able to edit the configuration. For example, you won't be able to add or delete function blocks, move items on the Function Block Diagram, or change configuration parameters of function blocks on their property pages. You will, however, be able to view the configuration parameters of function blocks on their property pages, but these values aren't being read from the controller. They exist only in the configuration open in Designer. That is why it is recommended that you perform an upload from the controller before monitoring so that current values from the controller are shown on the function block property pages."*

Select the Comm port and controller address to monitor. Press OK.

It checks to see if information is the same in the controller.

The feedback will be the monitor toolbar.

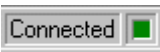
The Status Bar shows  on bar indicates that monitor mode is in effect. The green square is an activity indicator and flashes bright green when requests for monitored data are made to the controller.

There is also the word "Monitoring" indicated on the banner of the worksheet, the FBD worksheet background turns yellow and an eye appears with the cursor arrow.
 See "Visual Indicators for Monitor Mode" for on-line monitoring indicators.

Right Click Procedure in Monitor Mode

Depending where you right-mouse click on the FBD worksheet during monitoring, the resulting menu will have some differences.

In each column is shown the menu items that appear when you right-click on that item on your FBD during Monitor Mode.

Right click on these						
	Function Block	Variable	Yellow Space	Signal Tags	Connectors	Page Connectors
To see these choices	<u>Monitor Block</u>	<u>Monitor Block</u>	<u>Execution Order</u>	<u>Watch Summary</u>	<u>Watch Summary</u>	<u>Watch Summary</u>
	<u>Watch Summary</u>	<u>Watch Summary</u>	<u>Fast Logic Order</u>	<u>Add to Watch Summary</u>	<u>Add to Watch Summary</u>	<u>Add to Watch Summary</u>
	<u>Monitor Pins</u>	<u>Add to Watch Summary</u>	<u>Find</u>	<u>Monitor Pins</u>	<u>Monitor Pins</u>	<u>Monitor Pins</u>
	<u>Help</u>	<u>Monitor Pins</u>	<u>Go To</u>	<u>Help</u>	<u>Help</u>	<u>Help</u>
	<u>Execution Order</u>	<u>Help</u>	<u>View</u>	<u>Find Where Used</u>	<u>Find Where Used</u>	<u>Find Where Used</u>
	<u>Copy</u>	<u>Execution Order</u>	<u>Properties (File)</u>	<u>Properties (Signal Tag)</u>	<u>Properties (Connector)</u>	<u>Properties</u>
	<u>Properties (Function Block)</u>	<u>Copy</u>				
		<u>Properties (Function Block)</u>				

Right click on these			
	Input Pins	Output Pins	Wire Node
	<u>Trace</u>	<u>Monitor Pins</u>	<u>Help</u>
To see these choices	<u>Monitor Pins</u>		

Function Block Monitor Window

The Designer provides live monitoring of all Function Blocks.

To access, select "Monitor Function Block" from the "Monitor" menu or from the Monitor toolbar.



Or

Right Click a function block or variable in Monitor Mode and select the Monitor Block menu item.

The summary will provide status of the parameters shown in the list.

For "Loop" blocks, the current mode will be shown in the lower right of the window

LSP AUTO = Local Setpoint, Automatic Output

LSP MAN = Local Setpoint, Manual Output

RSP AUTO = Remote Setpoint, Automatic Output

RSP MAN = Remote Setpoint, Manual Output

To change Mode settings of a loop block, click on a radio button to select

Local or Remote Setpoint

Automatic or Manual Output

Click the "Change Mode" button to change the mode.

Changing a Parameter

Some blocks allow you to change some parameters. Click on a parameter name, if allowed the "Write" field will become active. Enter an override value in the field.

Channel/Sensor Status

I/O blocks display a parameter called Channel/Sensor Status to indicate any abnormalities. See I/O Channel/Sensor Status for details.

Click on "X" to exit box.

Attention: All function blocks dialog boxes have a "MONITOR" button when in Monitor mode that will access this window.

Below is an example of a Monitor Window for a PID block.

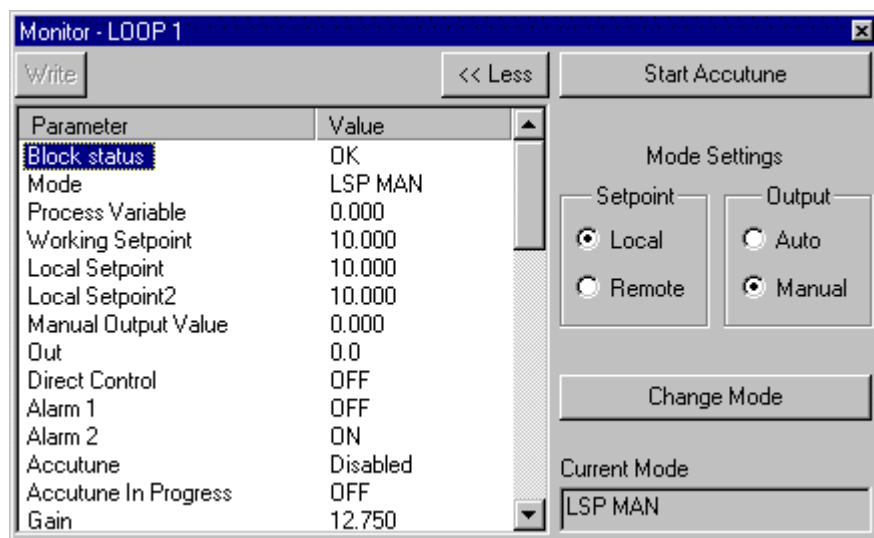

Forcing/Unforcing an Output

Overview

The ability to **force and unforce the output [pin]** of function blocks and variables from the Designer is provided as an aid to startup and configuration troubleshooting. The feature is limited to single output per block.

The majority of blocks have a single output, and most of the multiple output blocks have an obvious primary (i.e. most important) output. This may apply to the block's primary analog output (such as for an AI block) or digital output of a logic block (such as for a DI or DO block).

Note: A function block input is never forced.

Some blocks (i.e. Loop Blocks) do not have a forceable output. It is not possible to force/unforce function block outputs from the Operator Interface.

Variables, which are normally set to 0 on download of a new configuration or a change in configuration can have their output value changed on-line. You can also preset the value of a variable using an initialization procedure via function blocks or by setting the Initial Value field on the variable's property page.

You can also display a list of blocks that are presently being forced. See "Forced Blocks Window "

ATTENTION:

All forced outputs are cleared by a CONTROLLER COLD START.

CAUTION

During Live-Monitoring (especially fast logic), it is possible to see transient states where the block output is inconsistent with its input values. This occurs because it is possible for the input values and outputs values to be taken from different controller execution cycles. Therefore, either the viewed inputs or outputs may be "older".

SOLUTION: Recognize this possibility when interpreting results. Use forcing if necessary to create and assess static conditions.

Forcing an Output

Do an Upload to make sure the file is current.

Enter Monitor Mode - Select the Monitor Mode icon from the Main Toolbar, or select "Monitor Mode" from the Monitor menu. The FBD background turns yellow.

Right-Click on a selected function block, then select "Monitor Block". The "Monitor Block" dialog box will open.

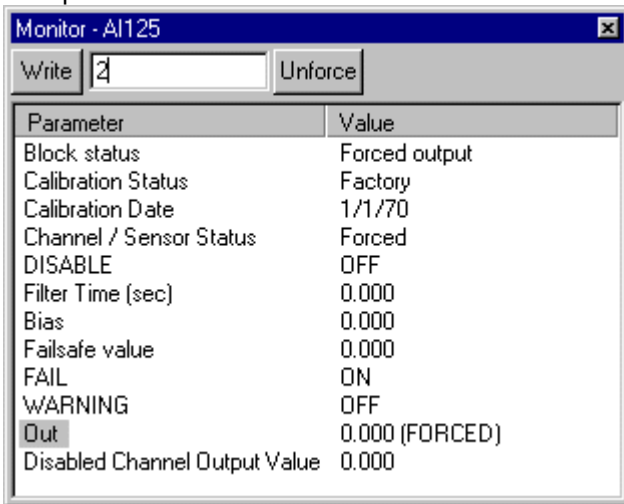

Select "OUT" or "Output" in the dialog box of the Live Monitor screen. If Forcing is allowed, the Write field becomes active. Enter the Output value in the entry field next to the "Write" button.

NOTE: for Loop Blocks, put the controller into Manual Mode

Click "WRITE". The output value will change to the value entered for forcing.

The word Forced will appear next to "Output" and "Block Status".

Changing (Force) a Digital Value from ON to OFF

Select "ON" or "OFF" from the drop down list box and click "WRITE". The selection for the parameter selected will change to the selection entered for forcing.

If there is a problem with the forcing

Check your communication Set Up for correct settings

Make sure the Mode Switch on the controller is in "RUN " mode.

Unforcing an Output

Right-Click on a selected function block, then select "Monitor Block". The "Monitor Block" dialog box will open.

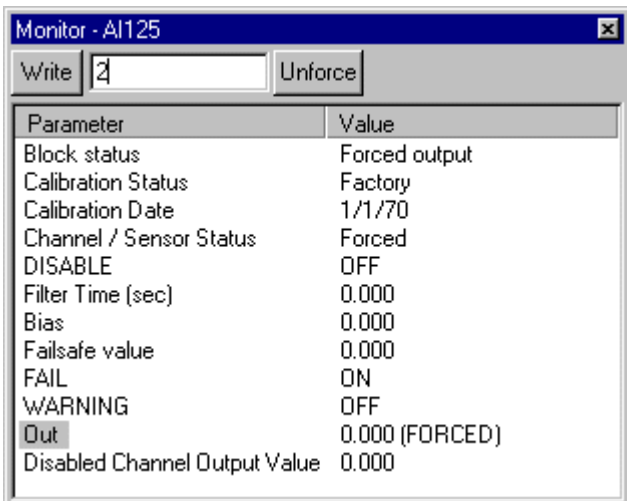

Click on the forced output (indicated by FORCED).

Click Unforce. The original selection for the parameter will return.

Forced Blocks Window

Overview

The Forced Blocks window provides a list view of all function blocks that have forced outputs and provides a quick means of removing the forced outputs on selected block. The Forcing and Unforcing of function block outputs is a feature that is only available in [Monitor Mode](#). For more information on how to force function block outputs see [Forcing/Unforcing an Output](#).

Opening the Window

The Forced Blocks Window is represented by the Exclamation Mark icon and can be accessed in 3 ways as described below. For each method, the system must already be in [Monitor Mode](#) for the option to be available.

Monitor Menu



4. Select **Monitor** from the main application menu.
5. Select  **Forced Blocks...** to launch the Forced Blocks window.

Monitor Mode Toolbar

1. Click on the  button in the **Monitor Mode Toolbar** from the main application toolbar.

Utilities Worksheet

1. Select the  **Utilities** tab from the main Worksheet Category Tabs to display the Controller Utilities worksheet.

2. Click on the  button to bring up the **Controller Diagnostics** submenu.
3. Select  **Forced Blocks...** to launch the Forced Blocks window.

Unforcing Block Outputs

There are two versions of the Forced Blocks dialog window, depending on whether or not the controller being monitored is one that supports the SIL Safety standard. For SIL compliant controllers the version shown on the left below will be displayed. For non SIL compliant controllers the version shown on the right below will be displayed.

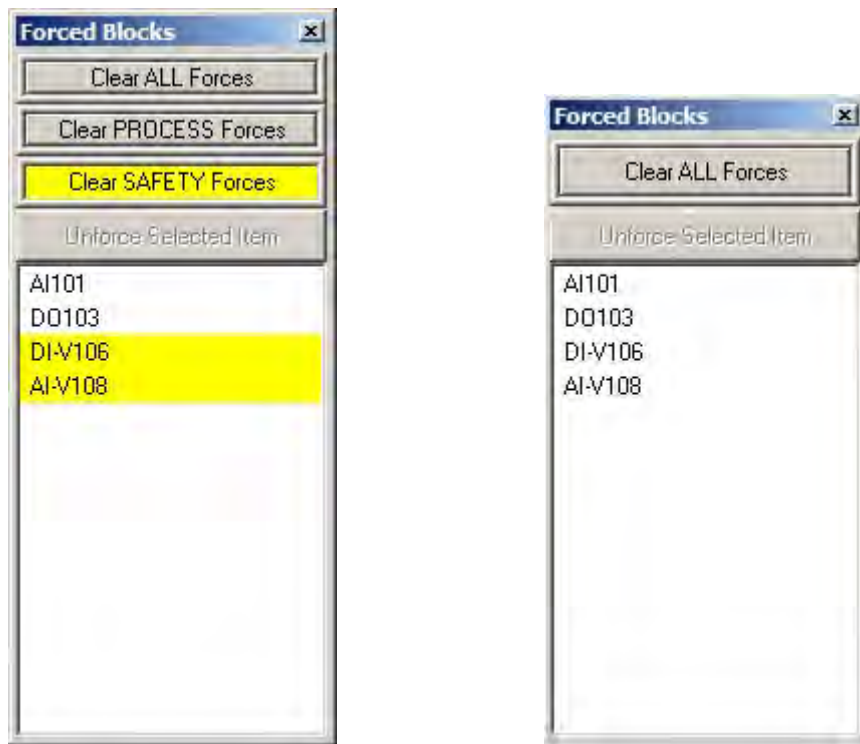

Both versions of the window have a list box displaying a list of all of the function blocks that currently have forced outputs.

- Function blocks located on a Safety worksheet have a yellow background.
- Function blocks located on a Process worksheet have a white background.
- If no function blocks have forced outputs the word NONE is displayed.
- If new forces are added or removed from individual function block monitor windows the list will be updated dynamically.

Both versions of the window have a **Clear ALL Forces** button that allows all forced outputs to be cleared with one click. For Safety enabled controllers there are additional **Clear PROCESS Forces** and **Clear SAFETY Forces** buttons that allow forced outputs on the Process and Safety worksheets to be cleared independently. In either, case a warning message similar to the one shown below will be displayed requesting confirmation before the action is taken.

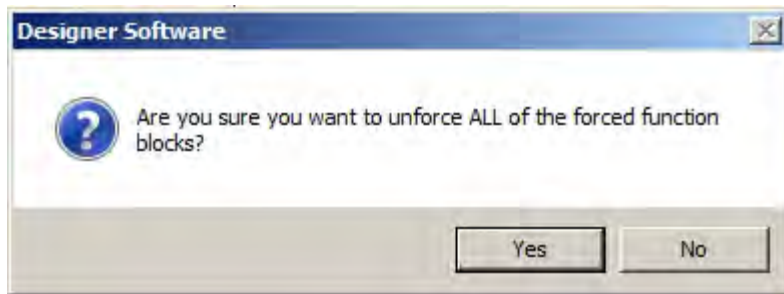

Both versions of the window have a **Unforce Selected Item** button that allows the output of a single function block to be unforced. To enable this button, click on the desired function block as shown below. (Multiple selections using the Shift or Ctrl keys are not allowed.)

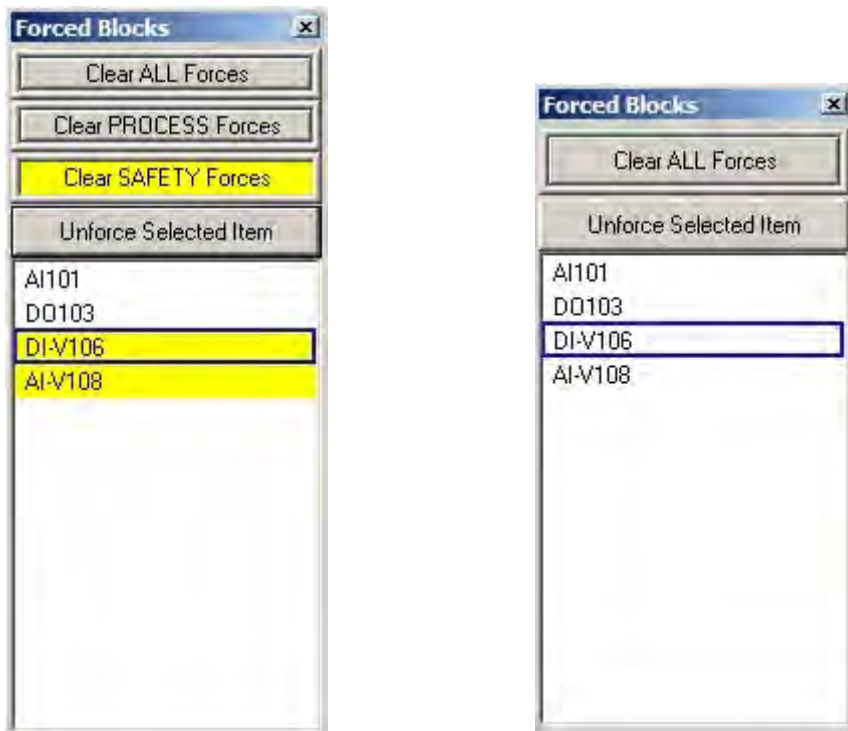

Clicking on the **Unforce Selected Item** will now clear the forced output on the selected function block. In this case the action takes place immediately and no confirmation is required.

Exiting

To close the Force Blocks window click on the **X** in the top right-hand corner.

See Also

[Monitor Mode](#)

[Forcing/Unforcing an Output](#)

[Watch Summary – Inputs/Outputs](#)

How Do I Stop Monitoring

Press the MONITOR button on the main toolbar.



This will return the associated configuration to EDITmode.

Feedback will be the monitor button (unpressed), and all open monitor windows will disappear. The FBD Worksheet background returns to white and the eye disappears from the cursor.

Attention: If you return from EDITmode to Monitor mode, all your previously opened monitor windows will appear (if the same configuration)

Logic Flow

Overview

In Monitor Mode, Logic Flow is shown within the Configuration Worksheet Monitor Window.

Soft Wires are identified to represent the Logic state at the pin of the source in monitor mode.

Function Block pin values can be monitored briefly or you can stick the values on display until you dismiss them. Analog Values are in decimal format and Digital States are On/Off.

Digital Signal Tags and corresponding Connectors at the block pins include color-coded representations for state changes.

Page Connectors include color-coded representations for state changes.

Logic Inversion indicators are pictorially identified on the block and are color-coded to identify logic states impeding or permitting logic flow.

CAUTION

During Live-Monitoring (especially fast scan), it is possible to see transient states where the block output is inconsistent with its input values. This occurs because it is possible for the input values and outputs values to be taken from different controller execution cycles. Therefore, either the viewed inputs or outputs may be "older". Logic monitoring is appropriate for static conditions.

Soft Wire Identification

Solid/Green = On, Dotted/Red = Off

Logic State at the Output Pin = ON

The Digital Signal Tag and its corresponding Connector/Page Connector will have the entire length of its tail drawn in solid GREEN.

Logic State at the Output Pin = OFF

The Digital Signal Tag and its corresponding Connector/Page Connector will have the entire length of its tail drawn in dashed RED.

On-Line Monitoring Logic Flow

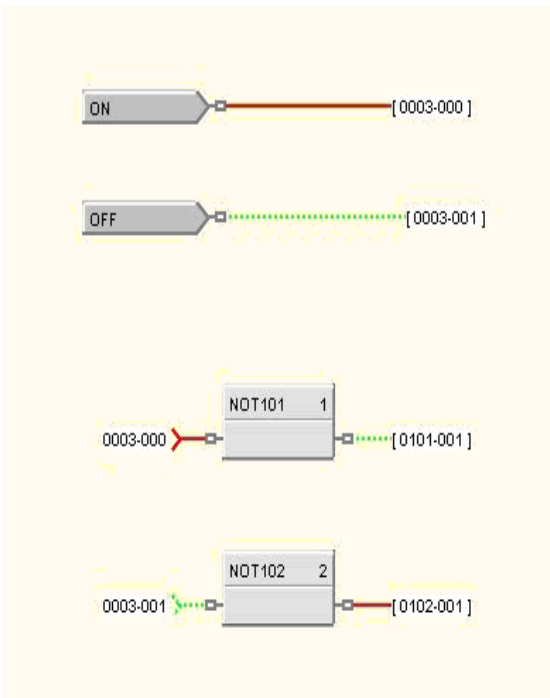

Solid/Red = On, Dotted/Green = Off

Logic State at the Output Pin = ON

The Digital Signal Tag and its corresponding Connector/Page Connector will have the entire length of its tail drawn in solid RED.

Logic State at the Output Pin = OFF

The Digital Signal Tag and its corresponding Connector/Page Connector will have the entire length of its tail drawn in dotted GREEN.

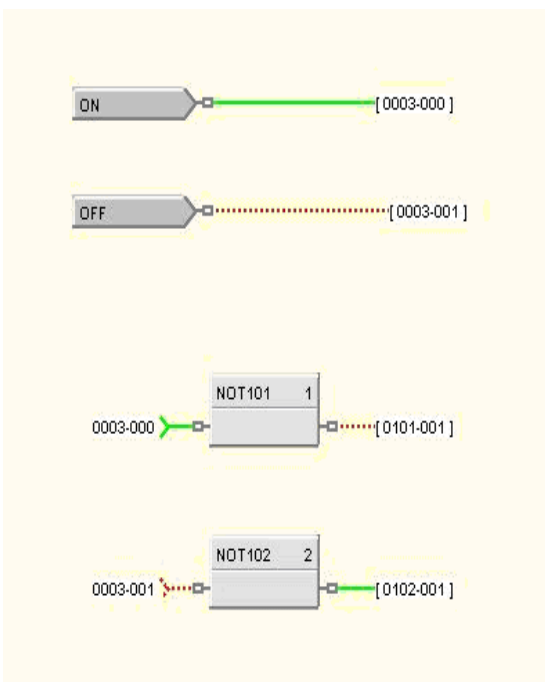

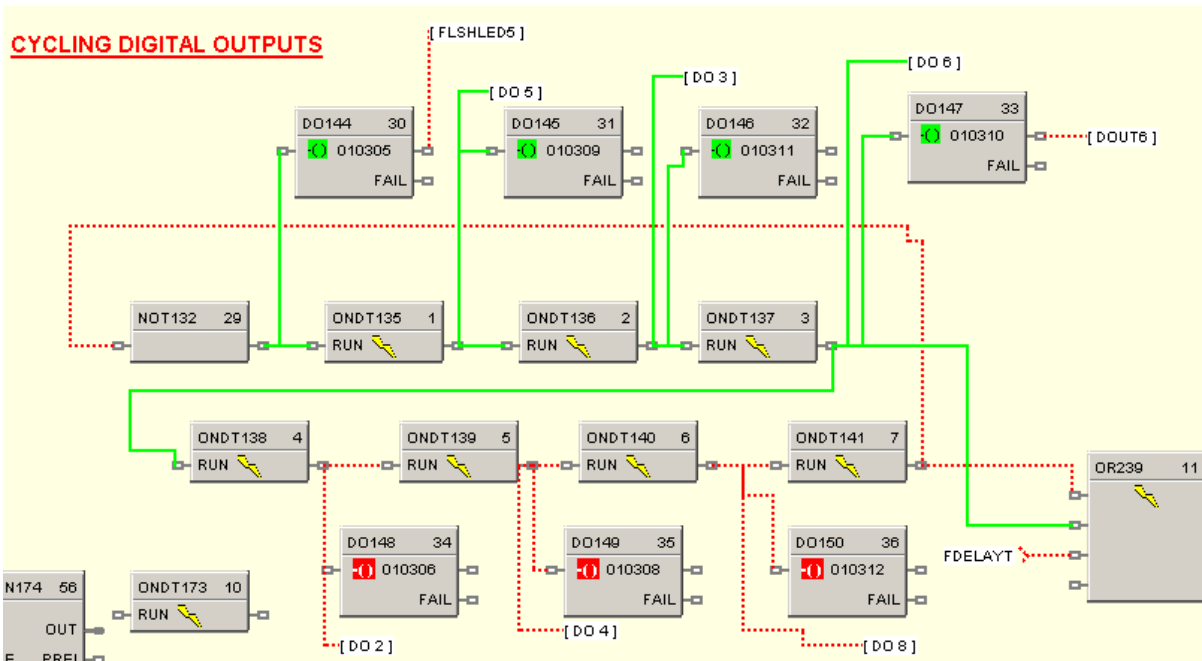

Signal Tags and Connectors/Page Connectors

Digital Signal Tags and Connectors/Page Connectors include color-coded representations for state changes as substitutes for soft-wires. To select one of the following color schemes, go to Monitor menu, then [Set Logic State Colors](#).

Solid/Green = On, Dotted/Red = Off

Logic State at the Output Pin = **ON**

The Digital Signal Tag and its corresponding Connector/Page Connector will have the entire length of its tail drawn in solid GREEN.

Logic State at the Output Pin = **OFF**

The Digital Signal Tag and its corresponding Connector/Page Connector will have the entire length of its tail drawn in dashed RED.

Solid/Red = On, Dotted/Green = Off

Logic State at the Output Pin = **ON**

The Digital Signal Tag and its corresponding Connector/Page Connector will have the entire length of its tail drawn in solid RED.

Logic State at the Output Pin = **OFF**

The Digital Signal Tag and its corresponding Connector/Page Connector will have the entire length of its tail drawn in dotted GREEN.

Displaying Function Block's Pin Values

Function Block pin value(s) can be monitored **briefly** and you can set one or all of the values on display (**constant display**) until you dismiss them. Analog Values are in decimal format and Digital States are On/Off.

Displaying a Single Pin Value

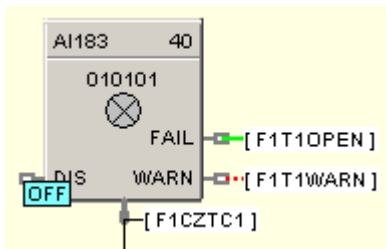

Displaying Briefly

Hover the cursor over any pin momentarily. The pin's value will be displayed next to the pin as long as the cursor remains motionless over the pin.

To **remove** the briefly displayed value:
remove the cursor from the pin.

Displaying Until Dismissed (Constant Display)

Hover the cursor over any pin and left-click while the pin value is displayed, or right-click and select "Monitor Pins" from the menu.

To **remove** the constantly displayed value:
left-click on the pin again, or
right-click and select "Monitor Pins" again from the menu.

Displaying All Function Block Pin Values

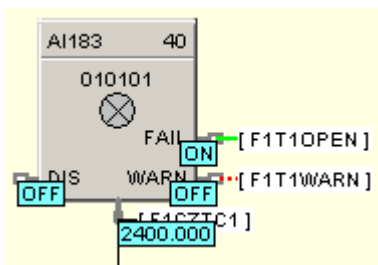

Displaying Briefly

Hover the cursor over the interior of a function block momentarily. All of the Function Blocks pin values will be displayed next to the pins as long as the cursor remains motionless over the block.

To **remove** the briefly displayed values:
remove the cursor from the block.

Displaying Until Dismissed

Hover the cursor over the interior of a function block and left-click while the pin values are displayed, or right-click and select "Monitor Pins" from the menu.

To **remove** the constantly displayed value:
left-click on the pin again, or
right-click and select "Monitor Pins" again from the menu.

Toggle All Pin Values on Worksheet



Select  on the Monitor Toolbar or select "Monitor Pins" from the Monitor menu.

NOTE: Any pin values shown when monitor mode is exited will be re-shown when Monitor mode is re-entered. This only applies to the current session of the application and not between sessions of the application.

Logic Inversion Color Codes

Certain function blocks (such as Discrete Input/Output and logic blocks) have an Invert feature that, when selected, inverts the state of the block's input or output. These blocks have special logic inversion indicators when viewed in monitor mode.

The examples below use the color scheme

RED = OFF
GREEN = ON.

To select the opposite color scheme

RED = ON
GREEN = OFF,
go to Monitor menu, then [Set Logic State Colors](#).

Logic Blocks Inversion Indicators

RED = OFF
GREEN = ON

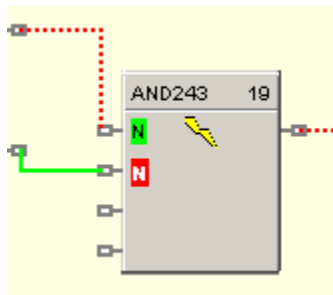

Digital Input Blocks Inversion Indicators

ON or **Inverted ON**

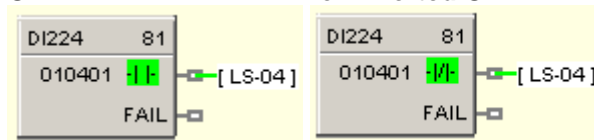

OFF or **Inverted OFF**

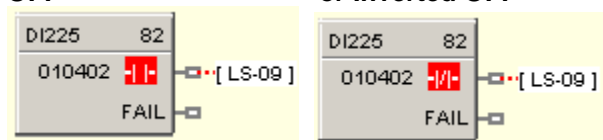

Digital Output Blocks Inversion Indicators

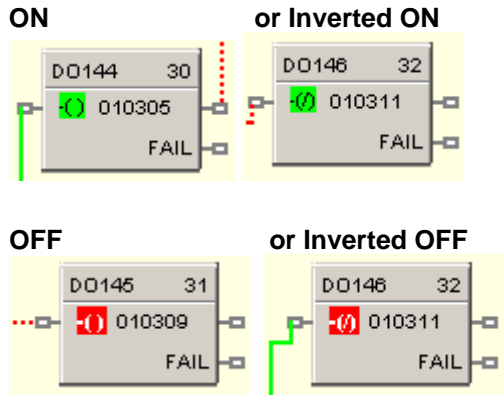

This page has been intentionally left blank

Watch Summary Window

Overview

Overview

The Watch Summary window is a dockable (movable), re-sizable window that lets you view the current values of groups of related data, such as I/O and Signal Tags, from the controller.

Opening the Window

The Watch Summary window is represented by the  icon and can be accessed in 2 ways as described below. For each method, the system must already be in [Monitor Mode](#) for the option to be available.

Monitor Menu

6. Select **Monitor** from the main application menu.
7. Select  **Watch Summary...** to launch the Watch Summary window.

Monitor Mode Toolbar

2. Click on the  button in the **Monitor Mode Toolbar** from the main application toolbar.

Using the Window

The Watch Summary window will have a slightly different appearance depending on the revision of software and the type of controller, however, the general layout is as shown below:

- Tab control to select from different groups of data
- Pull-down selectors at the top to further filter items within the group
- Table to display information and current values of the selected items

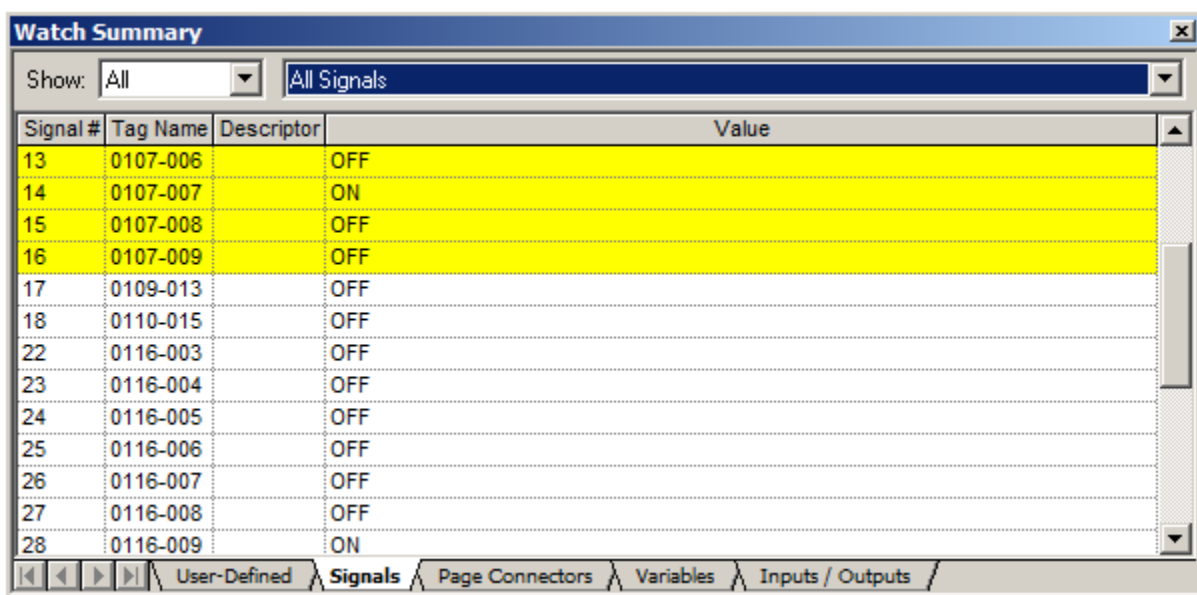

The number of different data groups available through the tabs at the bottom of the window will depend on the revision of software running in the controller. The possible selections are listed below (click on any of the links **to view an example** of the selected data for that tab):

- [User-Defined](#) (Customized list of Signals, Page Connectors and/or Variables)
- [Signals](#) (Analog, Digital)
- [Page Connectors](#) (Analog, Digital)
- [Variables](#) (Analog, Digital)
- [Inputs / Outputs](#) (AI, AO, DI, DO)
- [Display Groups](#) (Not available in revision 6.0 and higher)

The number of pull-down selectors at the top of the display will depend on the controller type. For SIL-compliant controllers there will be a leading selector which allows the data items within the group to be filtered based on the type of function block worksheet they are located on; Process, Safety or All (both Process and Safety worksheets).

For all controller types there will be a pull-down selector which allows the data items within the group to be further filtered based on a sub-type, such as analog versus digital, or input versus output. The list of available sub-types is determined by the data group selected through the tab control.

Information about each item in the filtered list is displayed in the table in the middle of the window. The amount of information displayed will vary based on the selected tab, but will always include a current value from the controller. The rows of data may be sorted by clicking in the header for most of the configuration information columns. Subsequent clicking within a column header will toggle between ascending and descending sort orders. (See also [Sort Feature](#))

For SIL-compliant controller types, the rows of data will be colored coded. Items located on a Safety worksheet will be displayed with a yellow background, whereas items located on a Process worksheet will be displayed on a white background.

Docking and Undocking the Window

Double clicking in the Title Bar area of the Watch Summary Window will toggle its docked state. If the window is docked, double clicking in the title bar area will undock the window. If the window is undocked

- Double-clicking in the title bar area will dock the window at its last docked position
- Dragging the window to the top, bottom, left, or right edge of the main viewing area of the application will dock the window at that location

[Press and hold the CTRL key down to prevent Docking when moving the window]

Hot Links

You can click on any I/O function block or Signal on the Controller Worksheet or any I/O function block, Signal, or Variable in the Watch Window and that item will be located on the Function Block Diagram.

As you move the mouse over a HOT LINK, the text changes to [Underlined Blue](#) and the cursor changes to a hand . (See also [Find Feature](#))

Writes or Forces

By clicking on the item in the Value column, you may write a value such as for a Variable or force a value for an analog input or digital input. For I/O, a Forced column will indicate that the I/O point is forced.

Find Feature

You can click on any I/O function block or Signal on the Controller Worksheet or any I/O function block, Signal, or Variable in the **Watch Window** and that item will be located on the Function Block Diagram.

As you move the mouse over a HOT LINK, the text changes to Underlined Blue and

the cursor changes to a Hand. 

You can also find within the Watch Summary window itself any tag, descriptor, signal number, variable number, as well as rack number, module number, channel number, or block on the Inputs / Outputs tab. For example, to find a tag in the Watch Summary window, click anywhere in the Tag Name column and start typing the characters of the tag you want to find. The tag matching the characters you type will scroll into view. To find a tag name and prevent the tag hot link from re-positioning the Function Block Diagram, right-click the tag name instead of left-clicking it.

Sort Function

The Sort function in the Watch Summary lets you sort the tag list by:

Signal #

Variable #

Tag Name

Descriptor

Block

At the top of the Watch Window, click on the **Column title**. The list will be sorted accordingly. Clicking the column title the first time sorts the list in ascending (alphabetical) order. Clicking the column title a second time sorts the list in descending (reverse alphabetical) order, and so forth.

Watch Summary - User Defined

On the User-Defined tab of the Watch Summary Window you can view a list of tags that you want to monitor. You can add the following to the list:

- **Signals**
- **Page Connectors**
- **Variables**

The Watch Summary window doesn't have to be visible in order to add items to the list of User-Defined tags to display, nor do the drop-down selectors on the User-Defined tab have to match what you'll be adding.

For example, you can add a signal to the User-Defined tab of the Watch Summary window even if the window is not visible or the User-Defined tab's "Show" drop-down selector is set to All Variables. As long as you are in monitor mode, you can add items at any time.

Note that there is no limit to the number of items that you can add to the list, but the list is not saved between sessions of the software.

To add Signals, Page Connectors or Variables to the user-defined watch list:

1. Navigate to the function block worksheet that contains the item.
2. Right-click on the item to display the context menu.
3. Select Add to Watch Summary from the context menu

(See the [Watch Window Summary](#) for instructions on how to view the Watch Summary Window.)

The number of pull-down selectors at the top of the User-Defined tab of the Watch Summary window will depend on the controller type. For SIL-compliant controllers there will be a leading

selector which allows the signals to be filtered based on the type of function block worksheet they are located on:

- All (both Process and Safety worksheets)
- Process
- Safety

For all controller types there will be a pull-down selector which allows the type of user-defined tags to be selected:

- All
- All Signals
- All Page Connectors
- All Variables

(Note that in this case “All” refers to the list of user-defined items and not to the full configuration.)

For each item in the selection list, its Tag Name, Descriptor and Value are displayed in the table, as shown below.

Tag Name	Descriptor	Value
VAR009		3.2450
VAR010		0.274
SET_RST		ON
SPS_NUM	Schedule	3
0118-004		3.851
0118-005		ON
0121-002		OFF
0104-008		0.836
0106-002		OFF
0104-010		ON
0104-011		OFF
0107-006		OFF
0107-008		OFF

For SIL-compliant controller types, the rows of data will be colored coded. Items located on a Safety worksheet will be displayed with a yellow background, whereas items located on a Process worksheet will be displayed on a white background.

You can change the value of any item that can be forced by entering a new value in the Value column.

You can re-order the items in the list by selecting a single row or range of rows in the list and dragging the row(s) to another position in the list. You can also delete selected items in the list.

To select the first row in a range:

- Positioning the cursor over the gray cell at the beginning of the row.
- Wait for the cursor to change to an arrow.
- Click on the gray cell.

To select the last row in a range:

- Positioning the cursor over the gray cell at the beginning of the row.

- Wait for the cursor to change to an arrow.
- Hold down the Shift key and click on the gray cell.

To reposition the selected row(s):

- Position the cursor over any gray cell in the selected rows.
- Drag and drop the rows to their new position.
- A red line will appear as you drag the rows to show you where the row that was clicked will be dropped when you release the mouse button.

To delete the selected row(s) press the Delete key.

Use the [Find Feature](#) to locate a specific I/O on the Function Block Diagram.

Use the [Sort Function](#) to sort the table rows by a specific column.

See the [Watch Window Summary](#) for more details on this window.

Watch Summary - Signals

On the User-Defined tab of the Watch Summary Window you can view a list of tags that you want to monitor. You can add the following to the list:

- **Signals**
- **Page Connectors**
- **Variables**

The Watch Summary window doesn't have to be visible in order to add items to the list of User-Defined tags to display, nor do the drop-down selectors on the User-Defined tab have to match what you'll be adding.

For example, you can add a signal to the User-Defined tab of the Watch Summary window even if the window is not visible or the User-Defined tab's "Show" drop-down selector is set to All Variables. As long as you are in monitor mode, you can add items at any time.

Note that there is no limit to the number of items that you can add to the list, but the list is not saved between sessions of the software.

To add Signals, Page Connectors or Variables to the user-defined watch list:

4. Navigate to the function block worksheet that contains the item.
5. Right-click on the item to display the context menu.
6. Select Add to Watch Summary from the context menu

(See the [Watch Window Summary](#) for instructions on how to view the Watch Summary Window.)

The number of pull-down selectors at the top of the User-Defined tab of the Watch Summary window will depend on the controller type. For SIL-compliant controllers there will be a leading selector which allows the signals to be filtered based on the type of function block worksheet they are located on:

- All (both Process and Safety worksheets)
- Process
- Safety

For all controller types there will be a pull-down selector which allows the type of user-defined tags to be selected:

- All
- All Signals
- All Page Connectors

- All Variables

(Note that in this case “All” refers to the list of user-defined items and not to the full configuration.)

For each item in the selection list, its Tag Name, Descriptor and Value are displayed in the table, as shown below.

Watch Summary - Page Connectors

The number of pull-down selectors at the top of the display will depend on the controller type. For SIL-compliant controllers there will be a leading selector which allows the page connectors to be filtered based on the type of function block worksheet they are located on:

- All (both Process and Safety worksheets)
- Process
- Safety

For all controller types there will be a pull-down selector which allows the type of page connectors to be selected:

- All Page Connectors
- Analog Page Connectors
- Digital Page Connectors

For each page connector in the selection list, its Tag Name and Value are displayed in the table, as shown below.

Tag Name	Value
ONOFF A2	OFF
0120-005	ON
PUMP 1 F	ON
ONOFF A1	OFF
FAN 1 FL	ON
FAN 2 F	OFF
MTR 2 AL	OFF

For SIL-compliant controller types, the rows of data will be colored coded. Page connectors located on a Safety worksheet will be displayed with a yellow background, whereas page connectors located on a Process worksheet will be displayed on a white background.

You cannot change the value of a page connector as they are Read Only.

Use the [Find Feature](#) to locate a specific I/O on the Function Block Diagram.

Use the [Sort Function](#) to sort the table rows by a specific column.

See the [Watch Window Summary](#) for more details on this window.

Watch Summary - Variables

The number of pull-down selectors at the top of the display will depend on the controller type. For SIL-compliant controllers there will be a leading selector which allows the variables to be filtered based on the type of function block worksheet they are located on:

- All (both Process and Safety worksheets)
- Process
- Safety

For all controller types there will be a pull-down selector which allows the type of variable to be selected:

- All Variables
- Analog Variables
- Digital Variables

For each variable in the selection list, its Number, Tag Name, Descriptor and Value are displayed in the table, as shown below.

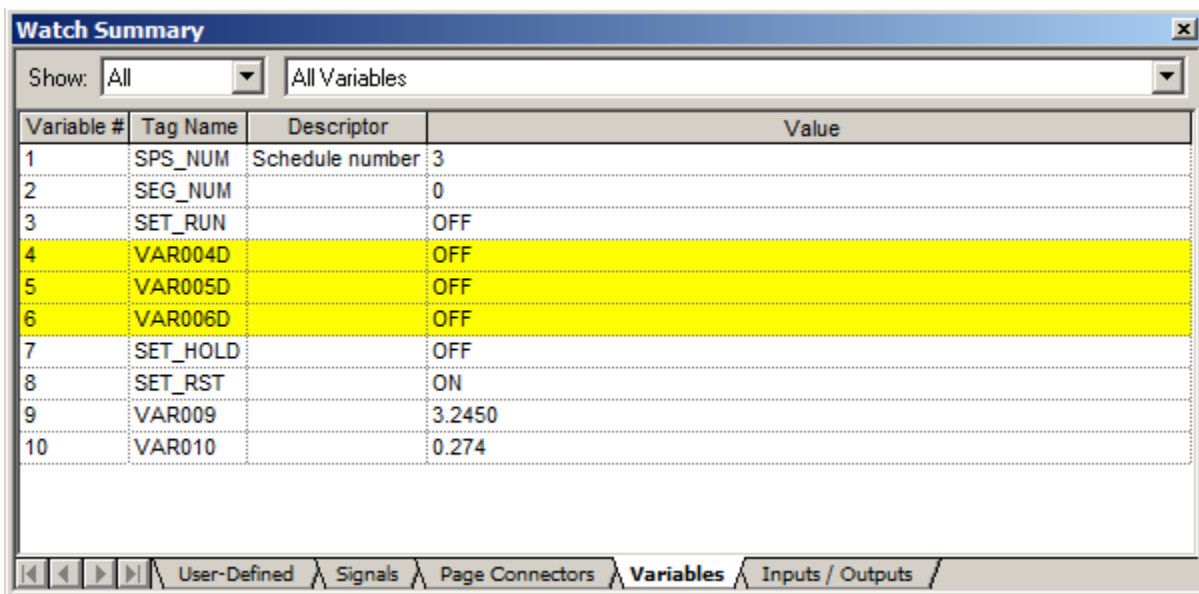

Variable #	Tag Name	Descriptor	Value
1	SPS_NUM	Schedule number	3
2	SEG_NUM		0
3	SET_RUN		OFF
4	VAR004D		OFF
5	VAR005D		OFF
6	VAR006D		OFF
7	SET_HOLD		OFF
8	SET_RST		ON
9	VAR009		3.2450
10	VAR010		0.274

For SIL-compliant controller types, the rows of data will be color coded. Variables located on a Safety worksheet will be displayed with a yellow background, whereas variables located on a Process worksheet will be displayed on a white background.

You can change a variable by clicking on a variable value and entering a new value for an analog variable or selecting the appropriate user-configured OFF or ON label from a drop-down menu for a Digital variable.

Note: *the new value entered is not written to the controller until you move off of the current cell either by tabbing out of the cell using the Shift+Tab keys or clicking on another cell using the mouse. If the value you want to change also shows engineering units, as in "100.0 LBS", for example, you just need to change the number portion; you don't need to delete the engineering units or type it in again.*

Use the [Find Feature](#) to locate a specific I/O on the Function Block Diagram.

Use the [Sort Function](#) to sort the table rows by a specific column.

See the [Watch Window Summary](#) for more details on this window.

Watch Summary - Inputs/Outputs

The number of pull-down selectors at the top of the display will depend on the controller type. For SIL-compliant controllers there will be a leading selector which allows the I/O points to be filtered based on the type of function block worksheet they are located on:

- All (both Process and Safety worksheets)
- Process
- Safety

For all controller types there will be a pull-down selector which allows the type of I/O point to be selected:

- Analog Inputs
- Analog Outputs
- Digital Inputs
- Digital Outputs

For each Input/Output in the selection list, its Rack, Module, Channel Number, Block Name, Tag Name, Descriptor, Value, and Status are displayed in the table, as shown below..

NOTE: Only "assigned" inputs and outputs are shown in this window. Inputs and outputs whose rack, module, and channel that are all zero are not shown in this window. These unassigned inputs and outputs are shown on the controller worksheet, however.

Rack	Module	Channel	Block	Tag Name	Descriptor	Value	Status
1	2	1	DI-V103	0106-002		OFF	Good
1	2	2	DI-V103	0106-003		OFF	Good
1	2	3	DI-V103	0106-004		OFF	Good
1	2	4	DO-V104			OFF	Good
1	2	5	DI111	0120-002		OFF	Good
1	2	9	8DI105			ON	<input checked="" type="checkbox"/> FORCED
1	2	10	8DI105			OFF	Good
1	2	11	8DI105			ON	<input checked="" type="checkbox"/> FORCED
1	2	12	8DI105			OFF	Good
1	2	13	8DI105	0109-013		OFF	Good
1	2	14	8DI105			OFF	Good
1	2	15	8DI105			OFF	Good
1	2	16	8DI105			OFF	Good

For SIL-compliant controller types, the rows of data will be colored coded. I/O blocks located on a Safety worksheet will be displayed with a yellow background, whereas I/O blocks located on a Process worksheet will be displayed on a white background.

You can Force an I/O by clicking on a value and entering a new value for an analog input or selecting the appropriate user-configured OFF or ON label from a drop-down menu for a digital input or output. A checked box and the word FORCED will appear in the Status column indicating that the I/O is forced. [Click off the value cell to see the box]

To **Remove a Force**, double-click to deselect the checked box.

Notes:

- Analog outputs cannot be forced.
- Safety I/O points cannot be forced while the controller is in Run mode.
- Time Proportioning outputs and Three position Step outputs cannot be monitored since the live value is maintained only on the D.O. module itself. The text "n/a" (for "not available") is shown as the value for these outputs.

Use the [Find Feature](#) to locate a specific I/O on the Function Block Diagram.

Use the [Sort Function](#) to sort the table rows by a specific column.

See the [Watch Window Summary](#) for more details on this window.

Watch Summary - Display Groups

This tab will only appear for Controller Revision Rev 4.4 and below. Watch Summary - Display Groups lets the user monitor the same points configured on the Operator Interface displays.

Select a **Display Group** (Show Menu) then a **Group Number** (Group Menu) from the drop-down menus at the top of the dialog box. The window will monitor the Display Group selected. Note that new values can be written to the variables shown in this window.

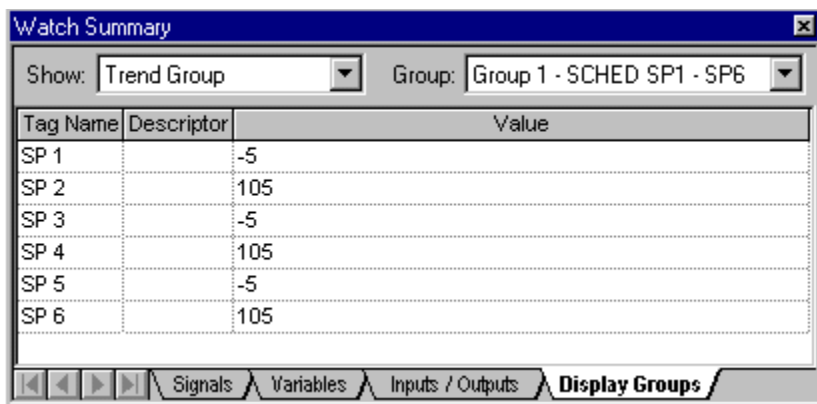

Use the "Find Feature " to Find a specific tag on the Function Block Diagram.

Use the "Sort Function " to sort the tag list by a specific column.

This page has been intentionally left blank

Diagnostics

Controller Diagnostics

Introduction

The Designer provides live monitoring of Controller diagnostics. The instrument executes diagnostic routines during instrument start-up and during on-line operation and displays the controller status and diagnostics.

1. Select "Controller Diagnostics" from the "Monitor" drop-down menu, from the Monitor toolbar.



(This window can be launched from the "Utilities Worksheet")

2. The Controller Diagnostics (C30/C50/C70) or Diagnostic Overview (C70R/C75) window will appear. See below.
3. The "Controller Diagnostic Status Indications" explains the parameters and their values.
4. Click on "X" to exit box.

C30/C50/C70:

Parameter	Value
Controller Time	10/27/01 9:51:35 AM
System Diagnostics	Good
CPU Diagnostics	Good
Memory Diagnostics	Good
Real-Time Clock Diagnostics	Good
Rack I/O Diagnostics	Module Error
Communication Port Diagnostics	Good
Hardware okay	OFF
Controller Mode	RUN
Code Revision	99.40
Code Build Revision	D
Loop Capacity	32
Product Type	HC900
Cycle Time (S)	0.51
CPU % used	3.29
Peak Time (S)	0.01
CB Overruns	0
Fast Cycle Time (S)	0.05
Fast CPU % used	0.00
Fast Peak Time (S)	0.00
Fast CB Overruns	0

C70R /C75:

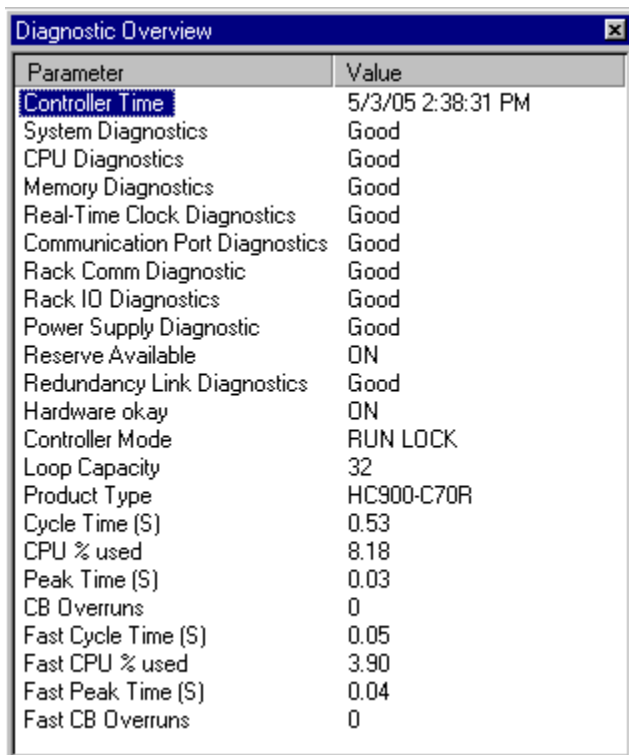

The image shows a screenshot of a software window titled "Diagnostic Overview". The window contains a table with two columns: "Parameter" and "Value". The "Controller Time" parameter is highlighted in blue. The table lists various diagnostic parameters and their current status or values.

Parameter	Value
Controller Time	5/3/05 2:38:31 PM
System Diagnostics	Good
CPU Diagnostics	Good
Memory Diagnostics	Good
Real-Time Clock Diagnostics	Good
Communication Port Diagnostics	Good
Rack Comm Diagnostic	Good
Rack IO Diagnostics	Good
Power Supply Diagnostic	Good
Reserve Available	ON
Redundancy Link Diagnostics	Good
Hardware okay	ON
Controller Mode	RUN LOCK
Loop Capacity	32
Product Type	HC900-C70R
Cycle Time (S)	0.53
CPU % used	8.18
Peak Time (S)	0.03
CB OVERRUNS	0
Fast Cycle Time (S)	0.05
Fast CPU % used	3.90
Fast Peak Time (S)	0.04
Fast CB OVERRUNS	0

Controller Diagnostics Status Indications

For C30/C50/C70, the "Controller Diagnostics" window appears. For C70R, the "Diagnostics Overview" window appears.

C30/C50/C70 Controller Diagnostics parameters

Parameter	Value	Possible Cause	Controller Action	User Action
System Diagnostics	Good	Controller is in RUN mode.	Executes the run mode. Outputs are updated.	None
	Forced Output	A block has an output that is forced.	None	Remove force on block output.
	Invalid Config.	A configuration that exceeds the loop capacity of the controller was downloaded or an invalid configuration exists.	An empty database is created.	Download a valid configuration.
	Switch Fault	A failure is detected in the switch reading.	All control blocks stop running All I/O scanning ceases. This forces the modules into failsafe.	Replace CPU.
	Invalid Change Of Mode	Controller mode is changed to RUN-Locked while there are forces on safety sheets.	Controller will not go to RUN-Locked mode.	To clear the diagnostic: 1. Change mode back to RUN mode OR 2. Clear all safety forces using HCD through Monitor->Forced Blocks OR 3. Force a cold-start
	Safety Configuration mismatch	Controller mode is changed to RUN-Locked when safety configuration is changed at run-time	Controller will not go to RUN-Locked mode.	To clear the diagnostic: 1. Change mode back to RUN mode OR 2. Force a cold-start
CPU Diagnostics	Good	N/A	N/A	N/A
	Watchdog	Watchdog reset resulting from software failure	Associated rack monitor block's RACK OK pin is turned off. ASYS block's HW OK pin is turned off.	1. Force a cold start. 2. Upgrade control file software. 3. Replace CPU board. 4. Contact Honeywell Personnel.

Diagnostics
Controller Diagnostics Status Indications

Parameter	Value	Possible Cause	Controller Action	User Action
	Prefetch Abort	CPU failed when attempting to fetch an instruction from the prefetch register.	<ol style="list-style-type: none"> 1. Controller performs a restart 2. Associated rack monitor block's RACK OK pin is turned off. 3. ASYS block's HW OK pin is turned off. 	<ol style="list-style-type: none"> 1. Force a cold start. 2. Isolate system from noise and force a cold start. 3. Replace CPU board
	Address Error	The reserved exception occurred for an unknown reason.	Same as above	Same as above
	Undefine Error	Bad Instruction Detected	Same as above	Same as above
	Data Abort	CPU failed when attempting to access data.	Same as above	Same as above
	Software Interrupt Error	Software Interrupt occurred which is not supported by the software.	Same as above	Same as above
Memory Diagnostics	Good	N/A	N/A	N/A
	5 Day Low Battery Warning	Estimated battery life is less than 5 days.	<ol style="list-style-type: none"> 1. Associated rack monitor block's RACK OK pin is turned off. 2. ASYS block's HW OK pin is turned off. 	Replace battery.
	Low Battery	Battery voltage is low.	<ol style="list-style-type: none"> 1. Associated rack monitor block's RACK OK pin is turned off. 2. ASYS block's LOW BATTERY pin is turned on. 3. ASYS block's HW OK pin is turned off. 	Replace battery.
	Flash Error	Flash failed to burn	<ol style="list-style-type: none"> 1. Associated rack monitor block's RACK OK pin is turned off. 2. ASYS block's HW OK pin is turned off. 	<ol style="list-style-type: none"> 1. Force a cold start. 2. Replace CPU board.
Real Time Clock	Good	N/A	N/A	N/A

Diagnostics
Controller Diagnostics Status Indications

Parameter	Value	Possible Cause	Controller Action	User Action
Diagnostics	Not Programmed	RTC not programmed	<ol style="list-style-type: none"> 1. Time and date is set to 00:00:00, January 1, 1970. 2. Associated rack monitor block's RACK OK pin is turned off. 3. ASYS block's HW OK pin is turned off. 	Program RTC.
	Bad Data	Bad date and time	Same as above	<ol style="list-style-type: none"> 1. Program RTC. 2. Cycle power. 3. Replace CPU. 4. Replace boards in rack. 5. Replace rack
	Programming Failure	RTC failed to program	Same as above	Same as above
	Read Failure	Unable to read RTC	Same as above	Same as above
Rack I/O Diagnostics	Good	N/A	N/A	N/A
	Module Error	One of the module diagnostics in the associated rack is set to WRONG MODULE, MODULE NO COMM (if the communications is failing due to the module not installed), BAD MODULE, or BAD CHANNEL.	Refer to related Module diagnostic.	Access the I/O Module diagnostics screen.
	Hi Temp	One of the module diagnostics in the associated rack is set to HI CJ TEMPERATURE.	Refer to HI CJ TEMPERATURE in Module diagnostics	Access the I/O Module diagnostics screen
	Rack Backplane Fail	The Main CPU/Scanner is unable to successfully communicate to any modules that are in its SPI backplane.	<p>All associated module diagnostics are set to MODULE NO COMM.</p> <p>Refer to MODULE NO COMM diagnostic for further details.</p>	<ul style="list-style-type: none"> • Remove modules and check for bent pins on connectors. • Reinsert modules one at a time and note which module the diagnostic reoccurs, and replace that module. • Cycle power to the rack. • Replace the power supply. • Replace the rack. • Replace the CPU board.

Diagnostics
Controller Diagnostics Status Indications

Parameter	Value	Possible Cause	Controller Action	User Action
	Rack Comm Fail	The Main CPU is unable to successfully communicate to an expansion rack that is in its configuration. Please note that there are NO expansion racks permitted on the HC900-C30 controller.	Same as above	<ol style="list-style-type: none"> 1. Verify that the expansion rack should be in the configuration 2. Verify that the jumpers on the scanner are setup for the correct rack address. 3. Check that expansion rack is on. 4. Check the expansion rack's status LED for diagnostic information. 5. Check that cable is connected to expansion rack. 6. If a hub is used, check that all cables are properly connected to the hub, proper crossover cables are used, and that hub is powered. 7. Cycle power to the rack. 8. Cycle power to the hub. 9. Replace the expansion rack's power supply. 10. Replace the expansion rack. 11. Replace the expansion rack's scanner board.
	Rack SW Incompatibility	The Main CPU determined that its software is not compatible with the scanner module.	All associated module diagnostics are set to MODULE NO COMM. Refer to MODULE NO COMM diagnostic for further details.	<ol style="list-style-type: none"> 1. Upgrade the scanner software either by replacing the module or doing a code-download. 2. Update Main CPU software either by replacing the module or doing a code download.
Comm Port Diagnostics	Good	N/A	N/A	N/A
	Warning	One of the comm port's is reporting an application error	<i>Refer to related Comm port diagnostic</i>	Access the Comm port diagnostics screen
	Failed	One of the Comm port's is reporting a physical or data link failure	<i>Refer to related Comm port diagnostic</i>	Same as above

C70R Diagnostic Overview parameters

Parameter	Value	Possible Cause	Controller Action	User Action
System Diagnostics	Good	Controller is in RUN mode.	Executes the run mode. Outputs are updated.	None
CPU Diagnostic	Good	System is functional	None	None
	Rack 'n'	Rack 'n' is reporting a diagnostic	Diagnostic may cause a failover Diagnostic may prevent a failover	Refer to the Rack Diagnostics for more details
	Multiple Racks	More than one Rack is reporting a diagnostic	Diagnostic may cause a failover Diagnostic may prevent a failover	Refer to the Rack Diagnostics for more details
	Lead CPU	The Lead CPU is reporting a diagnostic	None	Refer to the Lead CPU Diagnostics for more details
	Reserve CPU	The Reserve CPU is reporting a diagnostic	None	Refer to the Reserve CPU Diagnostic for more details
	Serial Port S1 or S2	There is a diagnostic on the Lead CPU Serial Port (S1 or S2)	None	Refer to the Serial Port S1 or Serial Port S2 Diagnostic Screen for more details
	Network E1 or E2	There is a diagnostic on the Lead CPU Network Port E1 or E2	None	Refer to the Network Port Diagnostic Screen for more details
	Scanner Link	Lead CPU is reporting a diagnostic on the Scanner Link	None	Refer to the Lead CPU Diagnostic and the Scanner Link Diagnostic screens for more details
	Redundancy Link	Lead CPU is reporting a diagnostic on the Redundancy Link. There is a problem with the communications between the Lead and Reserve CPUs.	None	Refer to the Lead and Reserve CPU Diagnostic screens for more details. Check the Redundancy Link Diagnostic screen for more details
Memory Diagnostic	See CPU Diagnostic for possible values			
Real-Time Clock Diagnostic	See CPU Diagnostic for possible values			
Communication Port Diagnostics	See CPU Diagnostic for possible values			
Rack IO	See CPU Diagnostic			

Diagnosics
Controller Diagnosics Status Indications

Parameter	Value	Possible Cause	Controller Action	User Action
Diagnosics	for possible values			
Rack Comm Diagnostic	See CPU Diagnostic for possible values			
Power Supply Diagnostic	See CPU Diagnostic for possible values			
Reserve Available	On	There is a Reserve CPU Available for failover		
	Off	<ol style="list-style-type: none"> 1. No Reserve CPU is available 2. Reserve CPU may be powered off 3. Reserve CPU is powered on but synchronizing with the Lead CPU 4. There may be other physical problems with the Reserve CPU 	System will not be able to perform a failover	<ol style="list-style-type: none"> 1. Check that Reserve CPU is powered ON 2. If powered ON, check the Reserve status LED on the Reserve CPU and the RSM Module 3. Check Reserve CPU Diagnosics for additional details
Redundancy Link Diagnosics	Good			
	Data Link Failure	<ol style="list-style-type: none"> 1. No Reserve CPU is available 2. Reserve CPU may be powered off 3. Reserve CPU is powered on but synchronizing with the Lead CPU 4. There may be other physical problems with the Reserve CPU 	System will not be able to perform a failover	<ol style="list-style-type: none"> 1. Check that Reserve CPU is powered ON 2. If powered ON, check the Reserve status LED on the Reserve CPU and the RSM Module 3. Check Reserve CPU Diagnosics for additional details
	Hardware Failure	There may be physical problems with the Lead CPU	System will not be able to perform a failover	Replace the Lead CPU

Rack Diagnostics

Introduction

The Designer provides live monitoring Rack diagnostics. The instrument executes diagnostic routines during instrument start-up and during on-line operation.

1. Select the "Rack Diagnostics" from the "Monitor" drop-down menu or from the Monitor Toolbar.



(This window can be launched from the "Utilities Worksheet"

2. The "Rack Diagnostic Summary" dialog box will appear.
3. Select a Rack from the "Monitoring Rack" drop-down menu on the dialog box. The information for the selected rack will appear on the dialog box.

4. The summary window will provide Controller status and diagnostic information **for the selected Rack:**

Rack in Configuration - ON or Off

High CJ Temp status - On or Off

Revision Level of the Rack - Read Only

Number of Slots - Read Only

Rack Diagnostics - The status of the selected rack. Refer to "Controller Diagnostics Status Indications" for diagnostic messages. Not all diagnostics appear for expansion racks.

Power Supply Diagnostics – C70R only. Status of the rack's power supply/supplies. See Rack Diagnostics: Power Supply .

Expansion I/O Comm Diagnostics (except C30 CPU) - The status of the Expansion I/O Comm Diagnostics. Refer to "Expansion I/O Comm Diagnostic Status Indicators". Read the diagnostics for a particular rack.

I/O Module Diagnostics - Status of the Modules shown in the list:

Physical Type

Configured as (type)

Error Status.

Model Number & Rev Level (scroll horizontally to view)

For status of individual I/O channels, see Function Block Monitor Window.

5. Click on upper right X to exit box.

C30/C50/C70:

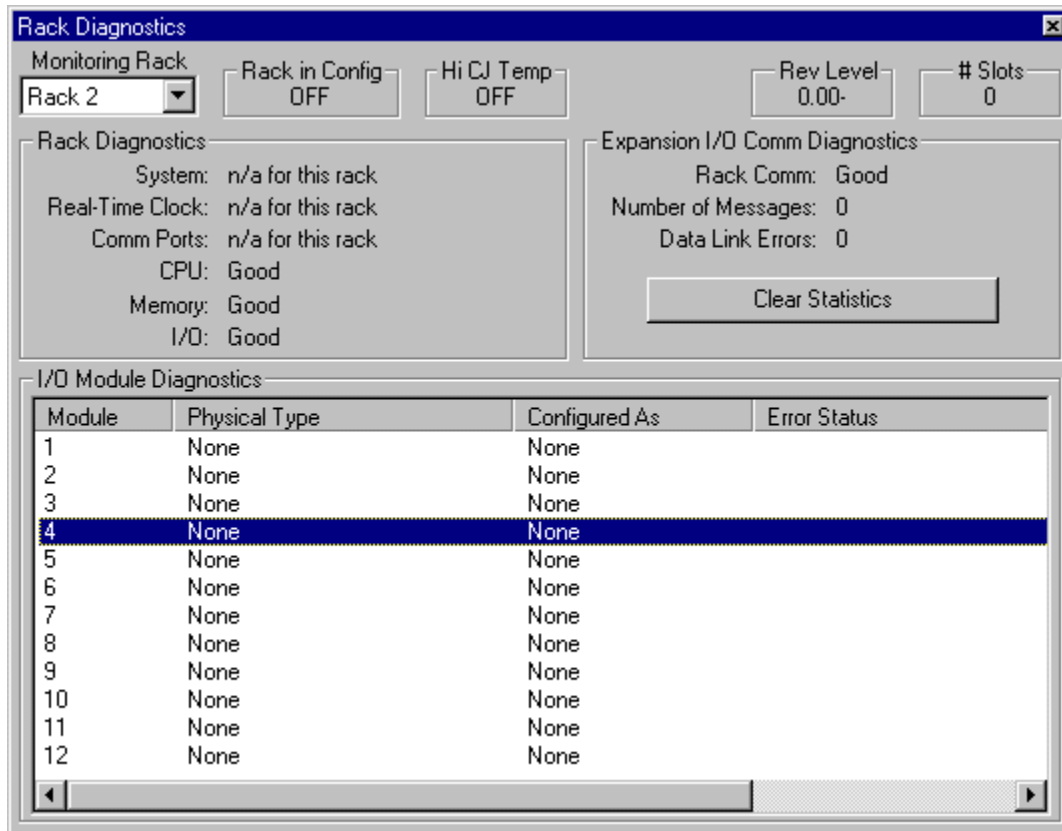

C70R:

The screenshot displays the 'Rack Diagnostics' window. At the top, it shows 'Monitoring Rack' set to 'Rack 5', 'Rack in Config' as 'ON', and 'Hi CJ Temp' as 'OFF'. It also indicates 'Rev Level' as '1.000' and '# Slots' as '12'. The 'Rack Diagnostics' section reports 'CPU: Good', 'Memory: Good', and 'I/O: Good'. The 'Power Supply Diagnostics' section shows 'Diagnostics: Good' and 'Status: Both power supplies are good'. The 'Expansion I/O Comm Diagnostics' section provides details for 'Lead Comm' and 'Reserve Comm', both in 'Good' status, with their respective slot positions (CPU A and CPU B), message counts, and zero data link errors. A 'Clear Statistics' button is located below this section. The 'I/O Module Diagnostics' section contains a table with the following data:

Module	Physical Type	Configured As	Error Status
1	None	None	
2	None	None	
3	DI 120/240 VAC 16-Chan	None	
4	DI 24 VDC 16-Chan	None	
5	None	None	
6	None	None	
7	None	None	
8	None	None	
9	DI 120/240 VAC 16-Chan	None	
10	DO Lo-Current Rly 8-Chan	Digital Output	
11	DO 120/240 VAC 8-Chan	None	
12	DO 120/240 VAC 8-Chan	Digital Output	

Rack Diagnostics: Power Supply

The Power Supply diagnostics provide status of the parameters shown in the list.

Parameter/ Message	Value	Possible Cause	Controller Action	User Action
Power Supply Status	Unknown	No rack communication.	If under power I/O will switch to failsafe values Loss of Comms	Determine & correct cause of communication failure
			If not powered (un-powered outputs) Loss of AC mains Bad power supply Failed scanner2	Restore rack operation Restore AC main power, reset breaker Replace Power supply Replace scanner2
	Redundant P/S is not present	Single power supply configuration	Status reported Rack continues to function properly	No action required if single power supply rack.
		Redundant Power Backplane not detected	Status reported Rack continues to function properly	If dual power supplies installed Replace Redundant Power Backplane Replace rack backplane Replace Scanner2.
	Power Supply PS-1 Failed (PS-1 LED is OFF)	No AC Mains on PS-1	Diagnostic reported. Rack continues to function properly. Status posted.	Restore AC main power, reset breaker.
		Failed Power Supply		Replace Power Supply
		Failed Redundant Power Backplane detection circuit		Requires unit shutdown - Replace Redundant Power Backplane
	(PS-1 LED is ON)	Failed rack backplane status signal		Requires unit shutdown - Replace rack backplane.
		Failed Scanner2 status input		Requires unit shutdown - Replace Scanner2.
	Power Supply PS-2 Failed (PS-2 LED is OFF)	No AC Main on PS-2	Diagnostic reported. Rack continues to function properly. Status posted.	Restore AC main power, reset breaker.
		Failed Power		Replace Power

Parameter/ Message	Value	Possible Cause	Controller Action	User Action
		Supply		Supply
		Failed Redundant Power Backplane detection circuit		Requires unit shutdown - Replace Redundant Power Backplane
	(PS-2 LED is ON)	Failed rack backplane status signal		Requires unit shutdown - Replace rack backplane.
		Failed Scanner2 status input		Requires unit shutdown - Replace Scanner2
	Both Power Supplies are Good	NA	None	None
Power Supply Diagnostic	See Power Supply Status for possible values			

I/O Module Diagnostics Status Indications

In the Rack Diagnostics window, the subsection I/O Module Diagnostics displays the Error Status for each module in the rack.

The following table lists the possible Error Statuses.

Error Status	Possible Cause	Controller Action	User Action
Good	N/A	N/A	N/A
Hi CJ Temperature	<p>Possible causes of this diagnostic are:</p> <p>One of the two CJs on the module is indicating a temperature reading greater than 70 degrees C.</p> <p>Both cold-junction sensors are failing to convert.</p> <p>The CJs are converting properly, but their differential is greater than 10 degrees C.</p>	<p>Associated AI blocks that are configured as T/Cs set their fail pin on, their warn pin off, and their output pin to the failsafe value.</p> <p>Associated AI blocks that are configured as T/Cs set their IO status to "CJ High Temperature" for reason 1 or "CJ Failure" for possible causes 2 and 3.</p> <p>Associated rack monitor block's module fail pin is turned on.</p> <p>Associated rack monitor block's RACK OK pin is turned off.</p> <p>Associated rack monitor block's HITEMP pin is turned on.</p> <p>ASYS block's HITEMP pin is turned on.</p> <p>ASYS block's HW OK pin is turned off.</p>	<p>Improve ventilation to rack</p> <p>Replace AI module</p>

Diagnostics
I/O Module Diagnostics Status Indications

Error Status	Possible Cause	Controller Action	User Action
Wrong Module	The module does not agree with the module required for the control scenario	<p>Associated blocks set their fail pin on, their warn pin off, and their output pin to the failsafe value.</p> <p>Associated blocks set their IO status to "Channel No Comm".</p> <p>Associated rack monitor block's module fail pin is turned on.</p> <p>Associated rack monitor block's RACK OK pin is turned off.</p> <p>ASYS block's HW OK pin is turned off.</p>	<p>Verify configuration</p> <p>Replace module with the correct one.</p>
#Module No Comm	<p>Main CPU is unable to communicate to the module for one of the following reasons:</p> <p>Module is not installed</p> <p>The module cannot communicate with the controller CPU or the expansion rack CPU because of a backplane problem. Module is on an expansion rack and the expansion rack communications are failing</p>	See Wrong Module.	<p>Action is based on the IODIAG indication. If IODIAG is not MODULE ERROR, then follow the prescribed action defined for that diagnostic.</p> <p>For MODULE ERROR, do the following:</p> <p>Verify configuration</p> <p>Install module.</p> <p>Check the communication cables that connect the expansion rack(s) to the Main Rack.</p> <p>Replace the controller or expansion rack backplane.</p>
Bad Module	Module is bad. Module LED flashes to indicate the problem.	N/A	See HC900 Controller Manual 51-52-25-107, I/O Module Indicators. A table describes the LED flashes and what they mean.
Bad Channel	One or more channels in the module is bad.	The I/O rack's Scanner status LED and the Controller rack's status LED (not the module or channel LED) flash 6 times.	<p>To determine which channel(s) are bad, monitor the function blocks corresponding to the channels in this module. See Function Block Monitor Window Check each I/O function block's "Channel/Sensor Status".</p> <p>2) To determine the cause, see HC900 Controller Manual 51-52-25-107, I/O Module Indicators, Bad I/O Channel Diagnostics. A table describes the channel statuses and what they mean.</p>

I/O Channel/Sensor Status

When monitoring blocks of the type in the table below, the Channel/Sensor Status is displayed. Statuses vary in severity; the more serious will trigger an error message/indicator elsewhere, such as a I/O Module Diagnostic Error or a flashing LED on the I/O rack.

Here is an alphabetical list of possible statuses for each I/O channel type.

Channel/Sensor Status	Channel type											Possible Cause	User Action
	AI	AO	DI	DO	TPO	TPSC	PI	PO	FI	QUAD			
Good	√	√	√	√	√	√	√	√	√	√	√	Normal operation	
Bad Channel		√							√			There are two possible causes for this error: 1. If the channel is an Analog Output: There is no physical output device connected to this channel, or the output device is showing an "open" connection. 2. If the channel is a Pulse Output: The channel is failing to output the correct value. A BAD CHANNEL I/O module diagnostic is posted.	Check terminal connections. Replace module.
Burnout Failure	√											The sensor – T/C, RTD, or mV source -- is failing burnout checks. A BAD CHANNEL I/O module diagnostic is posted.	Check terminal block connections Replace source element Replace module.
CJ Failure	√											Two conditions can create this failure. 1. Both cold-junction sensors are failing to convert. 2. The CJs are converting properly, but their differential is greater than 10 degrees C. In either case a HI CJ TEMP I/O module diagnostic is posted.	Improve ventilation to rack. Replace AI module.
CJ High Temperature	√											One of the CJs is indicating a temperature reading above 70 degrees C. A HI CJ TEMP I/O module diagnostic is posted.	Improve ventilation to rack. Replace AI module.
CJ Warning	√											One of the cold-junction sensors is failing to convert. The temperature compensation for the thermocouple readings could have a slight error because only the good CJ is being used in the temperature calculation.	
Clamp High		√										The AO block's input is greater than the block's configured high range value.	
Clamp Low		√										The AO block's input is less than the block's configured low range value.	
Disabled	√											AI channel is programmatically disabled	

Diagnostics
I/O Channel/Sensor Status

Channel/Sensor Status	Channel type										Possible Cause	User Action	
	AI	AO	DI	DO	TPO	TPSC	PI	PO	FI	QUAD			
Failed to convert	√											When attempting to take a reading, the analog-to-digital (ADC) fails. This can occur if the incoming signal is either too large or too small. It also could result if the ADC circuit is failing. If the problem is the ADC circuit, most likely other channels will have the same failure. A BAD CHANNEL I/O module diagnostic is posted.	Check the signal level being applied to the terminals. Replace module.
Forced	√		√	√								The point has been manually forced to its present value, probably via a PC host.	
No Channel Available	√		√	√				√	√	√	√	There is no hardware on the I/O module to support this channel. For example, the customer configured Channel #15 for a given module, but there is an 8-channel module installed in the rack. A BAD CHANNEL I/O module diagnostic is posted.	
No Comm	√	√	√	√	√	√						The Main CPU is unable to communicate to the channel. Possible reasons are module missing, wrong module installed, SPI backplane is failing, expansion rack is missing.	
Over current				√				√	√	√	√	A Digital Output module detected an excessive amount of current on its output terminals. Note that this message will only appear for the 32-channel DO module. A BAD CHANNEL module diagnostic is posted.	
Over range	√											The signal at the terminals is more than 10% over the range of the sensor.	Check the signal level being applied to the terminals. Replace module.
Sensor & Range type not available	√											The AI module installed in the rack does not support the range or sensor type configured for this channel. For example, this channel's AI function block is configured as a thermocouple, but there is a high-level AI module installed in the rack.	
T/C Failing	√											When burnout check occurs on the T/C, the measured resistance indicates that the T/C's resistance is to a point where the burnout failure will result.	
T/C Warning	√											When burnout check occurs on the T/C, the measured resistance is higher than normal.	
Under range	√											The signal at the terminals is less than 10% below the range of the	Check the signal level being applied to

Channel/Sensor Status	Channel type											Possible Cause	User Action
	AI	AO	DI	DO	TPO	TPSC	PI	PO	FI	QUAD			
												sensor.	the terminals. Replace module.
Wrong Firmware Rev	√											The firmware in the AI module is not compatible with the firmware in the controller or scanner CPU, or AI module does not support slidewire as an input type.	

Controller Ports Diagnostics







Accessing Port Diagnostics

Overview

The Designer provides live monitoring of Controller Ports diagnostics. The instrument executes diagnostic routines during instrument start-up and during on-line operation.

1. Select "Controller Ports Diagnostics" from the "Monitor" drop-down menu or from the Monitor toolbar.

There is a sub-menu from which you can choose the type of port you want to monitor:

Toolbar	Menu
	Serial Port S1 Configuration Port Diagnostics
	Serial Port S2 OI Port Diagnostics
	Network Port Diagnostics
	Expansion I/O Comm Diagnostics (except C30 CPU)
	Host Connections Diagnostics
	Peer-to-Peer Connections Diagnostics

The specific monitoring dialog box for that selection will open.

Serial Port S1 Configuration Port Diagnostics

The Designer provides live monitoring of the Serial Port S1 Configuration Port (default RS232). The instrument executes diagnostic routines during instrument start-up and during on-line operation.

Diagnostics

Controller Ports Diagnostics

1. Select "Controller Ports Diagnostics" from the "Monitor" drop-down menu then select "Serial Port S1" from the list provided or from the Monitor toolbar.



2. The "Serial Port S1 Diagnostic Summary" dialog box will appear. It shows Port Status, Diagnostics, Statistics and parameters for the Serial Port S1 Configuration Port. (This window can be launched from the "Utilities Worksheet")
3. The summary will provide status of the parameters shown in the list.
4. Click on "X" to exit box.

Refer to the Serial Port S1 Configuration Port Diagnostics Status Indicators for status indications, possible cause, and actions to correct the problem.

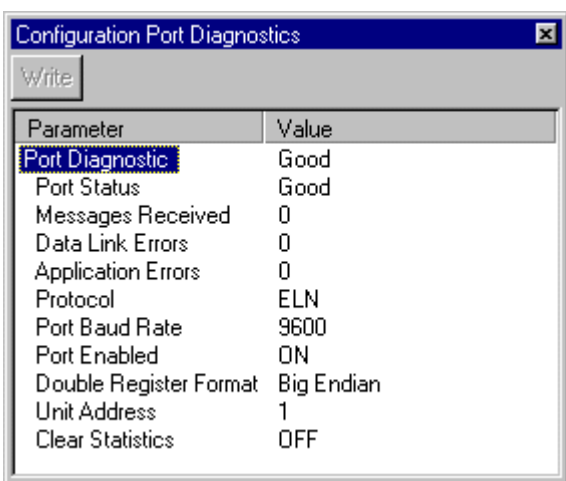
A screenshot of a Windows-style dialog box titled "Configuration Port Diagnostics". It has a "Write" button at the top left. Below the button is a table with two columns: "Parameter" and "Value". The table contains the following data:

Parameter	Value
Port Diagnostic	Good
Port Status	Good
Messages Received	0
Data Link Errors	0
Application Errors	0
Protocol	ELN
Port Baud Rate	9600
Port Enabled	ON
Double Register Format	Big Endian
Unit Address	1
Clear Statistics	OFF

Serial Port S1 Configuration Port Diagnostics Status Indicators

The "Serial Port S1 Diagnostic Summary" dialog box will provide status of the parameters shown in the list.

Parameter	Value	Possible Cause	Controller Action	User Action
Serial Port S1 Port Diagnostics	Good	N/A	N/A	N/A
	Data Link Failure	A large number of messages are resulting in data link errors.	<ol style="list-style-type: none"> 1. Rack 1 monitor block's COMPORT DIAG is set to FAILED. 2. Rack 1 monitor block's RACK OK pin is turned off. 3. ASYS block's HW OK pin is turned off. 4. If configured as a Modbus master: ASYS and FSYS blocks' Modbus Master Fail pins are turned on. <p>Slave and read blocks associated with the slaves experiencing the failure have their read pins frozen to the last value read.</p> <p>Slave blocks associated with the slaves experiencing the failure have their BAD COMM and NO SCAN pins turned on.</p> <p>IN SCAN STATUS is set to NO for all slaves experiencing the failure.</p> <p>COMM STATUS is set to BAD for all slaves experiencing the failure.</p> <p>The slaves with the data link errors have a non-zero data link error count.</p> <p>The slaves experiencing the failure are moved to the background scan rate.</p>	<ol style="list-style-type: none"> 1. Check baud rate 2. Check connectors 3. Check cable polarity 4. Isolate cabling from electrical interference 5. If RS232 to RS485 converter is used, check its power, switch/jumper settings, and polarity. 6. If configured as a Modbus master, use the slave status screens to determine which slaves are experiencing the problem. For those slaves check: <ul style="list-style-type: none"> • power • connections • address • baud rate • parity • number of stop bits • for electrical interference • grounding • termination resistor (if at end of link) 7. The diagnostic is cleared by clearing the port's statistics.

Parameter	Value	Possible Cause	Controller Action	User Action
	HW Failure	The DUART is failing to operate properly.	1.Rack 1 monitor block's COMPORT DIAG is set to FAILED. 2.Rack 1 monitor block's RACK OK pin is turned off. 3.ASYS and FSYS blocks' HW OK pins are turned off. 4.If configured as a Modbus master: <ul style="list-style-type: none"> i. ASYS and FSYS blocks' Modbus Master Fail pins are turned on. ii. All Modbus slave and Modbus read blocks have their read pins frozen to the last value read. iii. All slave blocks have their BAD COMM and NO SCAN pins turned on. iv. IN SCAN STATUS is set to NO for all slaves. v. COMM STATUS is set to BAD for all slaves in the function block diagram. vi. Statistical data for all slaves is frozen. vii. All slaves in the function block diagram are scanned at the background scan rate. 	Replace CPU module

Serial Port S2 Port Diagnostics

The Designer provides live monitoring of the S2 Port. The instrument executes diagnostic routines during instrument start-up and during on-line operation.

1. Select "Controller Ports Diagnostics" from the "Monitor" drop-down menu then select "Serial Port S2" from the list provided or from the Monitor toolbar.



2. The "Serial Port S2 Diagnostic Summary" dialog box will appear. It shows Port Status, Diagnostics, Statistics and parameters for the Serial S2 Port (default RS485 for 559/1042 Operator Interface). (This window can be launched from the "Utilities Worksheet").
3. The summary will provide status of the parameters shown in the list.
4. Click on "X" to exit box.

Refer to the Serial Port S2 Port Status Indicators for status indications, possible cause, and actions to correct the problem.

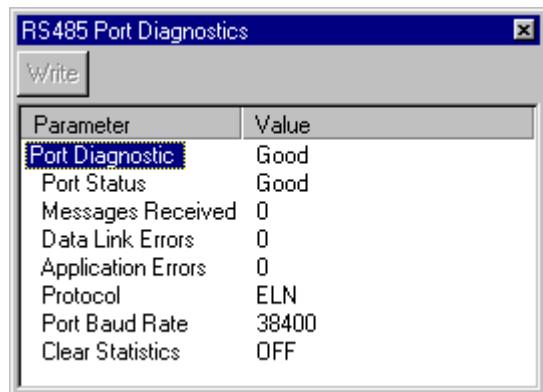

Serial Port S2 Port Status Indicators

The "Serial Port S2 Diagnostic Summary" dialog box will provide status of the parameters shown in the list.

Parameter	Value	Possible Cause	Controller Action	User Action
Serial Port S2 Diagnostics	Good	N/A	N/A	N/A
	Application Error	At least 1 response to a host resulted in an exception code or NAK.	<ol style="list-style-type: none"> 1. Rack 1 monitor block's COMPORT DIAG is set to WARNING. 2. Rack 1 monitor block's RACK OK pin is turned off. 3. ASYS block's HW OK pin is turned off. 	At host, determine which message is causing the exception code and fix.

Parameter	Value	Possible Cause	Controller Action	User Action
	Data Link Failure	A large number of messages are resulting in data link errors.	<ol style="list-style-type: none"> 1. Rack 1 monitor block's COMPORT DIAG is set to FAILED. 2. Rack 1 monitor block's RACK OK pin is turned off. 3. ASYS block's HW OK pin is turned off. 4. If configured as a Modbus Master port, associated slave blocks have their read pins frozen to the last value read. 	<ol style="list-style-type: none"> 1. Check baud rate 2. Check connectors 3. Check cable polarity 4. Isolate cabling from electrical interference 5. If RS232 to RS485 converter used, check its power, switch/jumper settings, and polarity.
	HW Failure	The DUART is failing to operate properly.	Same as above	Replace CPU module

Network Port Diagnostics

The Designer provides live monitoring of the Ethernet Network Port. The instrument executes diagnostic routines during instrument start-up and during on-line operation.

1. Select "Controller Ports Diagnostics" from the "Monitor" drop-down menu then select "Network Port" from the list provided or from the Monitor toolbar.



(This window can be launched from the "Utilities Worksheet"

2. The "Network Port Diagnostic Summary" dialog box will appear. It shows Port Status, Diagnostics, Statistics and parameters for the Ethernet Network Port.
3. The summary will provide status of the parameters shown in the list.
4. Click on "X" to exit box.

Refer to "Network Port Diagnostics Status Indicators" for status indications, possible cause, and actions to correct the problem.

Parameter	Value
Port Diagnostic	Good
Controller Name	PEER2
Network Name	UMC900 TEST
Local Alias	ARTS CONTROLLER
MAC Address	00-40-AF-FF-FF-F0
Network IP Address	164 . 145 . 185 . 57
Subnet Mask	255 . 255 . 255 . 0
Gateway Address	164 . 145 . 185 . 1
Outgoing Email (SMTP) Server Address	129 . 30 . 223 . 2

Network Port Diagnostic Status Indicators

The "Network Port Diagnostic Summary" dialog box will provide status of the parameters shown in the list.

Parameter	Value	Possible Cause	Controller Action	User Action
Network Port Diagnostics	Good	N/A	N/A	N/A
	Network Setup Error	Controller/network names determined on network are illegal	<ol style="list-style-type: none"> 1. Rack 1 monitor block's COMPORT DIAG is set to FAILED. 2. Rack 1 monitor block's RACK OK pin is turned off. 3. ASYS block's HW OK pin is turned off. 	Correct the setup problem.
	No IP Address	DHCP and IP address are not configured	Same as above	<ol style="list-style-type: none"> 1. If a DHCP server is present, download a configuration that uses DHCP. 2. Enter an IP address
	Hardware Failure	Ethernet port tests failed during power-up.	Same as above	Replace CPU Module

Expansion I/O Comm Diagnostics

The Designer provides live monitoring of the Expansion I/O (**except C30 CPU**) Comm subsystem. The instrument executes diagnostic routines during instrument start-up and during on-line operation.

1. Select "Controller Ports Diagnostics" from the "Monitor" drop-down menu then select "Expansion I/O Comm" from the list provided or from the Monitor toolbar.

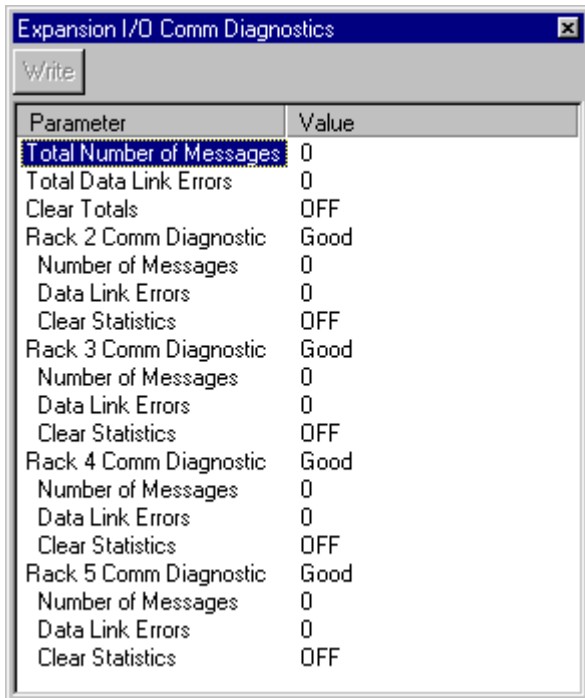

Parameter	Value
Total Number of Messages	0
Total Data Link Errors	0
Clear Totals	OFF
Rack 2 Comm Diagnostic	Good
Number of Messages	0
Data Link Errors	0
Clear Statistics	OFF
Rack 3 Comm Diagnostic	Good
Number of Messages	0
Data Link Errors	0
Clear Statistics	OFF
Rack 4 Comm Diagnostic	Good
Number of Messages	0
Data Link Errors	0
Clear Statistics	OFF
Rack 5 Comm Diagnostic	Good
Number of Messages	0
Data Link Errors	0
Clear Statistics	OFF

(This window can be launched from the "Utilities Worksheet")

2. The "Expansion I/O Comm Diagnostic Summary" dialog box will appear. It shows Port Status, Diagnostics, Statistics and parameters for the I/O Expansion I/O Comm subsystem.
3. The summary will provide status of the parameters shown in the list.
4. Click on "X" to exit box.

Refer to "Expansion I/O Comm Diagnostics Status Indicators" for status indications, possible cause, and actions to correct the problem.

Expansion I/O Comm Diagnostics Status Indicators

The "Expansion I/O Comm Diagnostic Summary" dialog box will provide status of the parameters shown in the list. **(except C30 CPU)**

Parameter	Value	Possible Cause	Controller Action	User Action
Rack Comm Diagnostics	Good	N/A	N/A	N/A
	Data Link Failure	The communications to a particular rack is resulting in a lot of DLL errors.	<ol style="list-style-type: none"> 1. Related rack monitor block's RACK OK pin is turned off. 2. Depending on the nature of the DLL errors, the associated rack monitor block's module diagnostics, and pins could be affected. 	<ol style="list-style-type: none"> 1. Use the OI to determine which rack is experiencing the DLL errors. Verify that the expansion rack should be in the configuration 2. Verify that the jumpers on the scanner are setup for the correct rack address. 3. If a hub is used, check that all cables are properly connected to the hub, proper crossover cables are used, and that hub is powered. 4. Cycle power to the rack. 5. Cycle power to the hub. 6. Replace the HC900-C50 expansion rack's power supply. 7. Replace the HC900-C50 expansion rack. 8. Replace the HC900-C50 expansion rack's scanner board. 9. Replace the main CPU.

Diagnostics
Controller Ports Diagnostics

Parameter	Value	Possible Cause	Controller Action	User Action
	Hardware Failure	The power-up test of the expansion rack Ethernet controller failed.	<ol style="list-style-type: none"> 1. All rack monitor block XIO PORT DIAG are set to HWFAIL. 2. All rack monitor block RACK OK pin are turned off. 3. All modules in the configuration have their diagnostic set to MOD_NOCOMM, their rack monitor module fail pin is turned on., and the rack monitor block's RACK OK pin is turned off. 4. ASYS block's HW OK pin is turned off. 5. The statuses for the AO and AI channels that are affected are set to BAD_CHANNEL. 	Replace main-CPU module
	Port A/B Cable Mismatch	C70R only. The I/O cables from CPUA and CPUB are connected to the wrong ports on the I/O scanner CPU	Controller continues to run but is not able to access the I/O on the associated rack	Swap the cables so that I/O A is connected to I/O on CPUA and I/O B is connected to I/O on CPUB
	Protocol Mismatch	C70R only. The firmware version in the controller CPU is not compatible with the firmware version in the I/O scanner	Controller continues to run but is not able to access the I/O on the associated rack	Upgrade the firmware in the CPU and/or scanner to be compatible versions

Host Connections Diagnostics

The Designer provides live monitoring of the Host Connections. The instrument executes diagnostic routines during instrument start-up and during on-line operation.

1. Select "Controller Ports Diagnostics" from the "Monitor" drop-down menu then select "Host Connections" from the list provided or from the Monitor toolbar.



(This window can be launched from the "Utilities Worksheet")

2. The "Host Connections Diagnostic Summary" dialog box will appear.
3. The summary will provide status of the parameters shown in the list.
4. Click on "X" to exit box.

Refer to "Host Connections Diagnostics Status Indicators" for status indications, possible cause, and actions to correct the problem.

Host Connections Diagnostics	
Parameter	Value
Port Diagnostic	Good
Protocol	None
Network IP Address	0 . 0 . 0 . 0
Messages Received	0
Application Errors	0
Clear Statistics	OFF
Port Diagnostic	Good
Protocol	None
Network IP Address	0 . 0 . 0 . 0
Messages Received	0
Application Errors	0
Clear Statistics	OFF
Port Diagnostic	Good
Protocol	None
Network IP Address	0 . 0 . 0 . 0
Messages Received	0
Application Errors	0
Clear Statistics	OFF
Port Diagnostic	Good
Protocol	None
Network IP Address	0 . 0 . 0 . 0
Messages Received	0
Application Errors	0
Clear Statistics	OFF

Host Connections Diagnostics Status Indicators

The "Network Host Connections Diagnostic Summary" dialog box will provide status of the parameters shown in the list.

Parameter	Value	Possible Cause	Controller Action	User Action
Network Host Connections Diagnostics	Good	N/A	N/A	N/A
	Application Error	At least 1 response to a host resulted in an exception code	1.Rack 1 monitor block's COMPORT DIAG is set to WARNING. 2.Rack 1 monitor block's RACK OK pin is turned off. 3.ASYS block's HW OK pin is turned off.	At host, determine which message is causing the exception code and fix.

Peer-to-Peer Connections Diagnostics

The Designer provides live monitoring of the Peer-to-Peer Connections. The instrument executes diagnostic routines during instrument start-up and during on-line operation.

1. Select "Controller Ports Diagnostics" from the "Monitor" drop-down menu then select "Peer-to-Peer Connections" from the list provided.
2. (This window can be launched from the "[Utilities Worksheet](#)") Select "Controller Diagnostics" icon then select "Controller Ports Diagnostics" then "Peer-to-Peer" Connections.
3. The "Peer-to-Peer Connections" dialog box will appear.

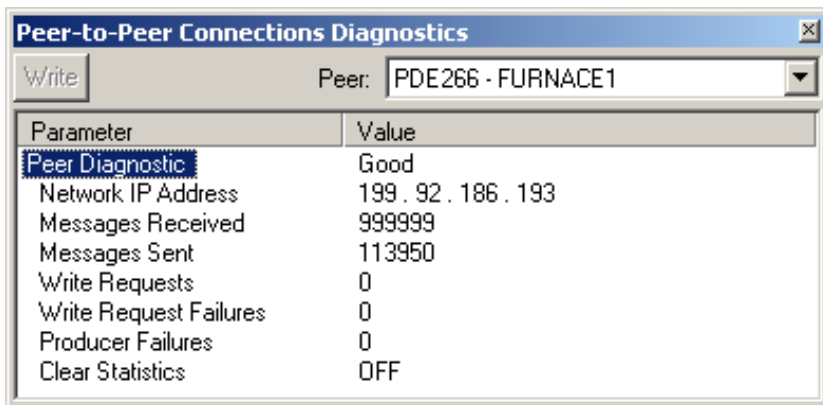

4. The summary will provide status of the parameters shown in the list.
5. Click on "X" to exit box.

Refer to "[Peer-to-Peer Connections Diagnostics Status Indicators](#)" for status indications, possible cause, and actions to correct the problem.

Peer-to-Peer Connections Diagnostics Status Indicators

The "Peer-to-Peer connections" dialog box will provide status of the parameters shown in the list.

Value	Possible Cause	Controller Action	User Action
Good	N/A	N/A	N/A
Application Error	The peer connection could not be established due to an internal program problem.	N/A	<ol style="list-style-type: none"> 1. Reset the controller to restart the UDP/IP protocol stack and reset buffer allocations. 2. Contact Honeywell Technical Assistance if the problem exists.
Setup Error	The peer device indicated that one or more data item is not valid.	<p>The error will occur when an incompatibility exists between peer devices with regard to variable or signal assignments.</p> <p>This error should not occur when exchanging data between HC900 controllers.</p>	Contact Honeywell Technical Assistance if the status occurs.
Peer Fail	The assigned peer could not be located on the network.	N/A	<ol style="list-style-type: none"> 1. Check the controller name and network name of the peer device to assure that they match that specific PDE block. 2. Check that the IP addresses of the peer devices are all within the range of the IP mask. 3. Check that the peer devices have the same IP subnet mask. See Network parameters for IP mask setting.
Port Fail	The peer data exchange IO subsystem could not be started due to internal resource problem.	N/A	<ol style="list-style-type: none"> 1. Reset the controller to restart the Ethernet IO hardware and reassign processor IO mapping. 2. Contact Honeywell Technical Assistance if the problem exists.
Not Started	The assigned peer IO connection has not yet been attempted. Normal state during startup and during configuration mode. This status should automatically change to GOOD after both peer controllers are in the RUN mode.	N/A	<ol style="list-style-type: none"> 1. If this status persists during run time, check that the peer device is properly connected and that the control name and network name is correct. 2. Check that the IP masks of all peer devices to assure that all IP addresses are within the same subnet. 3. Check that all external network components such as switches and routers allow passing of UDP packets on port 502. 4. Check that the peer device is powered on and is in RUN mode.

Parameter	Value	Possible Cause	Controller Action	User Action
Peer-to-Peer Connections Diagnostics	Good	N/A	N/A	N/A
	Network Setup Error	Controller/network names determined on network are illegal	Rack 1 monitor block's COMPORT DIAG is set to FAILED. Rack 1 monitor block's RACK OK pin is turned off. SYSTEM MONITOR block's HW OK pin is turned off.	Correct the setup problem.
	No IP Address	IP address is not configured	See Network Setup Error	Enter an IP address.
	Hardware Failure	Ethernet port tests failed during power-up.		Replace CPU module

Modbus Master (Serial) Port Diagnostics

Displays the status of the Modbus Master port, if so configured.

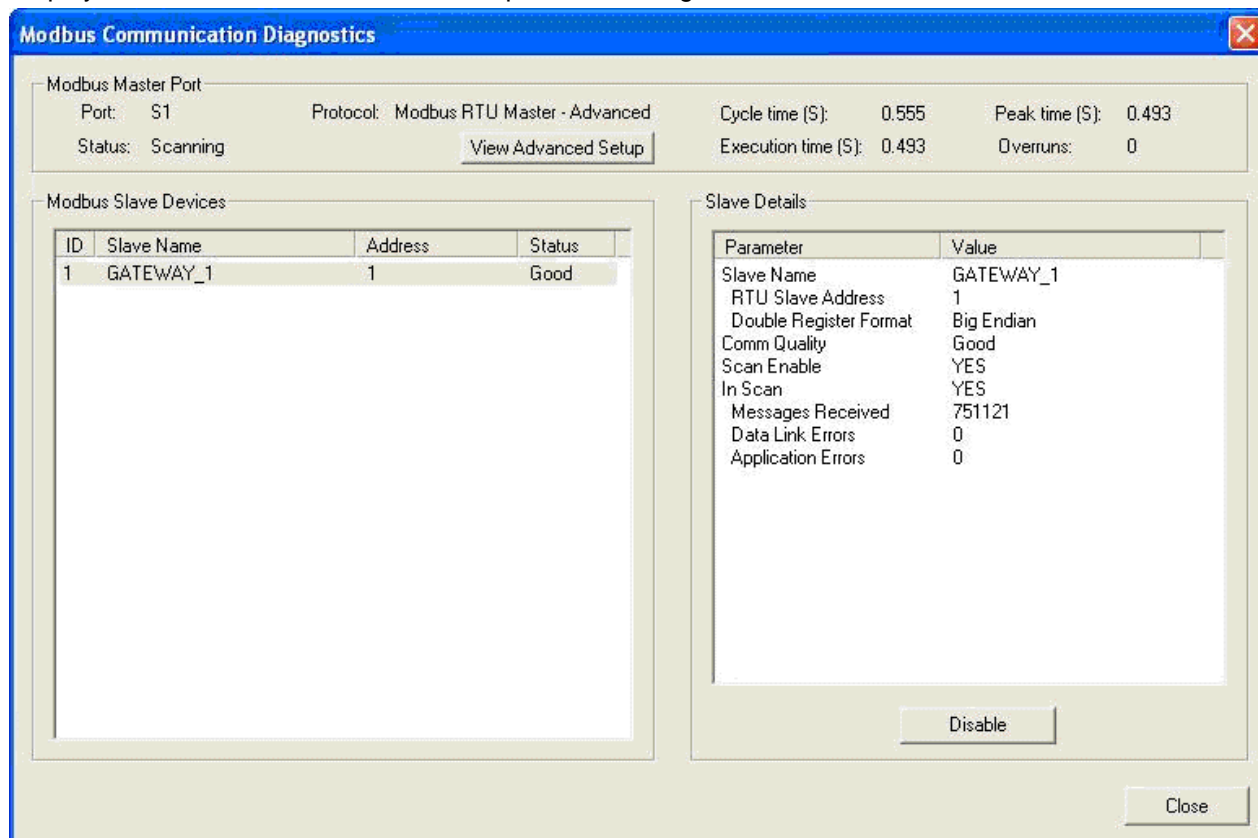

Access

Enter Monitor mode and select Modbus master port diagnostics from the Monitor menu or through the Utilities tab/Controller Diagnostics icon.

Port

S1	The controller's S1 port is the Modbus Master port.
S2	The controller's S2 port is the Modbus Master port.
No Master Port	The HC900 configuration contains Modbus slave blocks, but neither the S1 or the S2 port is configured as a Modbus Master. Use Set Controller Serial Ports on the Utilities tab to set up a Modbus Master port.

Master port status

The master port S1 or S2 is shown along with its status.

Modbus Master Port Status	Meaning
No Slave Blocks	There are no MBS (Modbus Slave) Blocks in the configuration
Program Mode	Controller is in Program Unlocked Mode, Modbus Slave Communications is disabled; return to Run to communicate to Slave Devices
ELN Slave	Controller is in Program Locked Mode; Port switches to Serial ELN Protocol while in this mode.
Scanning	Port is configured as a Modbus Master. Controller is in RUN or OFFLINE mode and is scanning the slave devices.

Protocol

Shows the [protocol](#) for the port. If Modbus RTU Advanced, you can click on [View Advanced Setup](#).

Cycle time (S)

This is the computed cycle time of the Modbus Master link. This time is computed by the HC900 controller.

Execution time (S)

This is the actual execution time of the Modbus Master link as measured by the HC900 Controller.

Peak time (S)

This is peak execution time of the Modbus Master link, as measured by the HC900 controller.

Overruns

This parameter counts the number of times that the actual execution time of the Modbus Master link exceeded the computed Cycle Time. Overruns can occur in the following situations:

- The baud rate configured for this serial port is incorrect.
- There is a physical problem on the serial communications link (e.g., a bad connection, a faulty or disconnected communications cable).
- The Slave Reply Timeout value is too small (this applies to Modbus RTU Master Advanced protocol only). If overruns continue to accumulate you may need to increase this value.
- Changing the serial port setup parameters. There may be a momentary overrun when the new parameters are saved to the controller.

Any persistent overrun condition should be investigated and corrected. Note that occasional overruns may occur during normal operation of the system if the scanning of the Modbus Master link is delayed by a higher priority activity.

The Overruns counter can be reset to zero by selecting Clear Statistics on the Serial Port S1 or S2 Diagnostics display.

Slave status

Under Modbus Slave Devices click on any slave name (left) to view its details (right). Some details show the configuration of the [Modbus Slave](#) function block.

The slave's Status (left) is the same as under Details, Comm quality (right).

Slave status/Comm Quality	Meaning
NONE	Slave communications are disabled.
BAD	Errors are occurring in the communications. Possible causes to check for: Physical link might be bad Slave device might be off No slave device found at the selected Modbus Address Slave device set to the wrong baud rate.
GOOD	Slave communications are normal

Port scanning

To enable/disable port scanning for a slave device:

1. Click a Modbus slave device in the slave device window. Slave details will appear at left.
2. Click on the Enable/Disable button at the bottom right to enable/disable the port scanning of that slave device.

Modbus Initiator (TCP) Port Diagnostics

Displays the status of the Modbus/TCP Initiator port, if so configured.

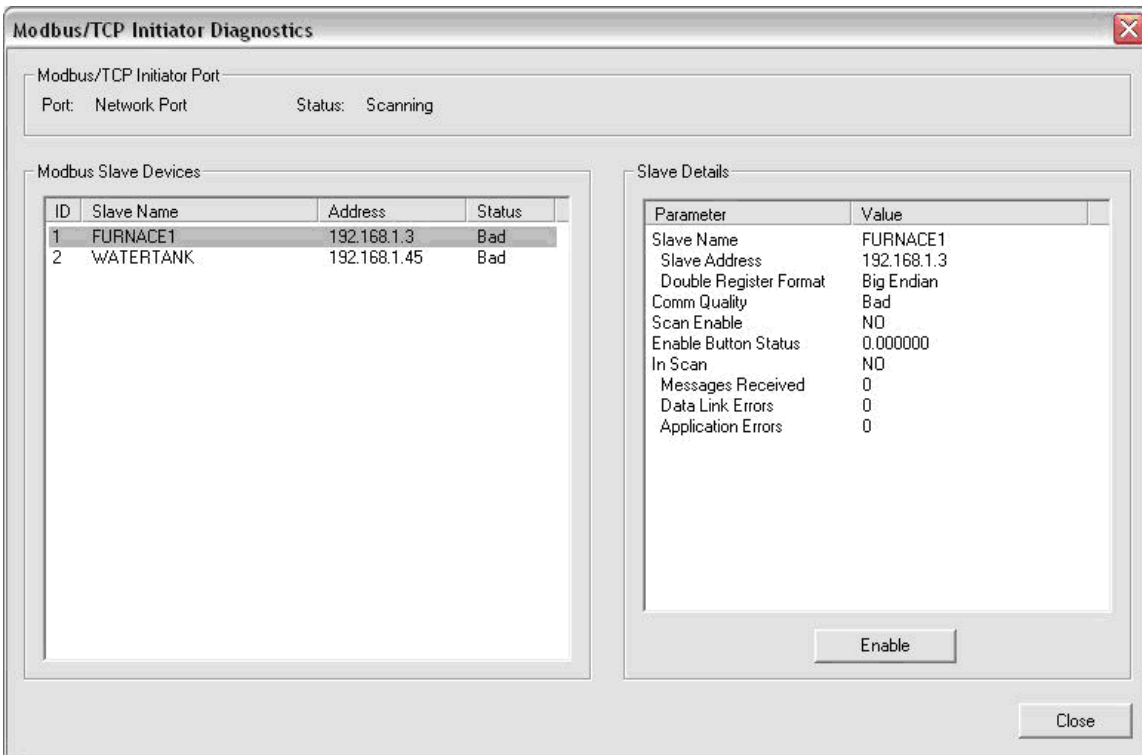

Access

Enter Monitor mode and select Modbus/TCP Initiator Port Diagnostics from the Monitor menu or through the Utilities tab/Controller Diagnostics icon.

Modbus/TCP Initiator port status

Status	Meaning
No Slave Blocks	There are no TCPS (Modbus/TCP Slave) Blocks in the configuration
Scanning	Controller is in RUN or OFFLINE mode and is scanning the Modbus/TCP slave devices.

Slave status

Under Modbus Slave Devices click on any slave name (left) to view its details (right). Some details show the configuration of the Modbus/TCP Slave function block.

The slave's Status (left) is the same as under Details, Comm quality (right).

Slave status/Comm Quality	Meaning
NONE	Slave communications are disabled.
BAD	Errors are occurring in the communications. Possible causes to check for:

Diagnostics
Modbus Initiator (TCP) Port Diagnostics

	Physical link might be bad Slave device might be off No slave device found at the selected Modbus IP Address Slave device set to the wrong baud rate.
GOOD	Slave communications are normal

Port scanning

To enable/disable port scanning for a slave device:

1. Click a Modbus slave device in the slave device window. Slave details will appear at left.
2. Click on the Enable/Disable button at the bottom right to enable/disable the port scanning of that slave device.

This page has been intentionally left blank

Reports

Print Report



Select "Print Report" from the File menu. If you selected  from the Custom Modbus Map toolbar it will print the currently displayed partition.

Print Report lets you print a report for various functions.

Click on the Icon on the toolbar and select a report from the drop-down menu that appears.

The "Print" dialog box will open to let you print a specific report.

You can also print a report from "Print Report Preview" from the File menu.

Report Categories

The Print Report function provides access to the greatest number of reports. For software revisions prior to 6.0, all 5 main report categories are available. For revision 6.0 and later the Display worksheet is no longer supported, so the Displays report category option is not available. For SIL compliant controller types, additional sub-menus allow for filtering of some reports based on Process or Safety worksheets. For more information see [Reports Overview](#).



Controller Reports

Clicking on the **Controller** button provides a drop-down menu which allows the selection of 2 different reports, as shown below. Note that for SIL compliant controller types only; there is an additional sub-menu for the I/O Configuration report.

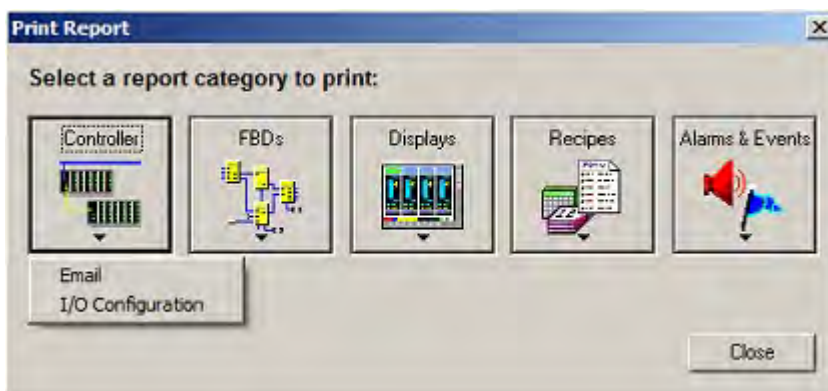

Report	Description	SIL Filtering
Email	Shows how E-mail notification is configured.	No
I/O Configuration	Shows configuration of all I/O on all racks. This report is similar to the data shown on the Controller worksheet . It may also be printed by clicking on the Print button in the Controller Configuration Toolbar .	Yes

Function Block Diagram Reports

Clicking on the **FBDs** button provides a drop-down menu which allows the selection of reports or report sub-categories related to the items contained on the function block diagrams of the configuration. The available report options for configurations with a [Fixed Modbus Address Map](#) are shown in the first figure below. The available report options for configurations with a [Custom Modbus Address Map](#) are shown in the second figure below.

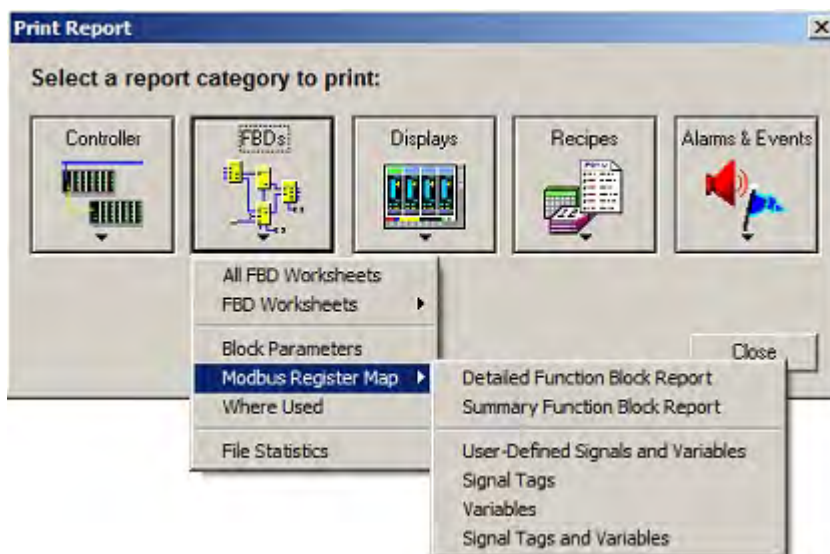

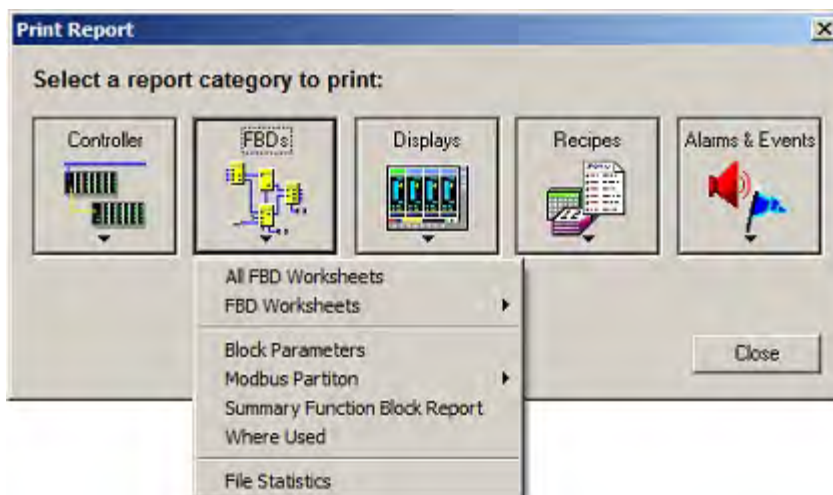

Report	Description	SIL Filtering
All FBD Worksheets	Not a traditional report. Prints out the graphical representation of all Function Block Diagrams in the configuration.	Yes
FBD Worksheets	Not a traditional report. Prints out the graphical representation of a single Function Block Diagrams from the configuration. Hovering over this menu option will display a sub-menu(s) which allows selection of the desired function block diagram worksheet.	Yes
Block Parameters	Shows a detailed report of each function block's parameters. [Modbus Register Map] (<i>appears if using fixed map</i>)	Yes
Detailed Function Block Report	Shows the starting Modbus address of each function block, as well as the Modbus addresses of all its parameters. Click here for details.	Yes
Summary Function Block Report	Shows the starting Modbus address of each function block. Click here for details. (also available if using custom map)	Yes
User-Defined Signals and Variables	Shows the user-defined Modbus addresses of signals and variables.	Yes
Signal Tags	Shows the system-defined Modbus addresses of all signal tags.	Yes
Variables	Shows the system-defined Modbus addresses of all variables.	Yes

Signal Tags and Variables	Shows the system-defined Modbus addresses of all signal tags and variables. [Modbus Partition] (<i>appears if using custom map</i>)	Yes
Modbus Partition	Shows the Modbus addresses and contents of the selected partition. Hovering over this menu option will display a sub-menu(s) which allows selection of the desired partition. The report generated by this method is equivalent to the report printed when the same Modbus address partition is selected in the Custom Modbus Map worksheet and the Print button on the worksheet's toolbar is clicked.	No
Where Used	Shows location (worksheet and page) of every item in the function block diagram.	Yes
File Statistics	Shows useful file statistics. Schema # is a database revision code used by the controller, OI and the software to ensure compatibility	No

Display Reports

Clicking on the **Displays** button provides a drop-down menu which allows the selection of 4 reports related to displays, as shown below. As noted above, this category is not available starting with revision 6.0.



Report	Description	SIL Filtering
General Settings	Shows Operator Interface settings (security, startup display, filenames).	No
Help Screens	Shows Operator Interface help screens.	No
Assigned Display Keys	Shows Operator Interface displays and contents for each display button.	No
Data Storage	Shows data storage settings (trend group data points,	No

Settings batch enable, etc.)

Recipe Reports

Clicking on the **Recipes** button provides a drop-down menu which allows the selection of 4 reports related to recipes, as shown below.

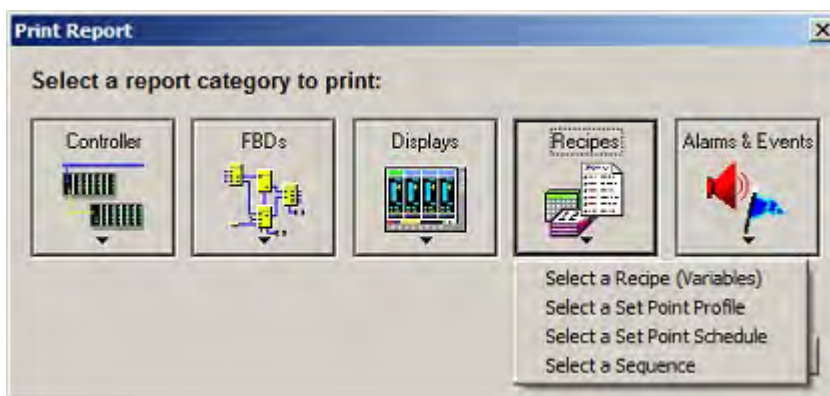

Report	Description	SIL Filtering
Select a Recipe (Variables)	Shows contents of the selected recipe (variables, descriptions).	No
Select a Set Point Profile	Shows contents of the selected Setpoint Profile.	No
Select a Set Point Schedule	Shows contents of the selected Setpoint Schedule.	No
Select a Sequence	Shows contents of the selected Sequence.	No

Selecting any of the 4 report options noted above brings up a selection dialog similar to the one below that allows one of the available Variables, Set Point Profile, Set Point Schedule or Set Point Sequences to be selected from a pool for printing. Clicking on the **Print** button completes the report printing.

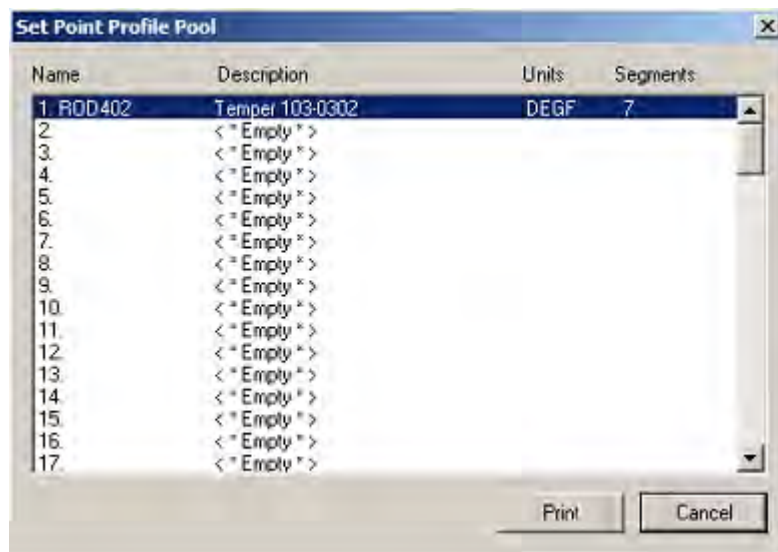

Alarms & Events Reports

Clicking on the **Alarms & Events** button provides a drop-down menu which allows the selection of 2 reports related to displays, as shown below.



Report	Description	SIL Filtering
Alarm Groups	Shows contents of each Operator Interface alarm group display.	Yes
Events	Shows all configured events and their triggers.	Yes

See Also

- [Reports Overview](#)
- [Print Report Preview](#)
- [Export Report](#)

Print Report Preview

Report Categories

The Print Report Preview function provides a means of previewing reports before they are printed. As such, the reports available for previewing is essentially the same as those available in the [Print Report](#) function. The one notable exception is that the option to preview the printing of all Function Block Diagrams at once is not supported.

Navigation

A toolbar at the top of the Print Report Preview window lets you navigate through the pages of the report:

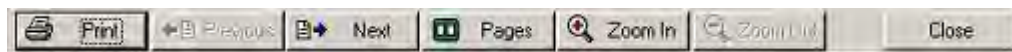

The functions from left to right are:

Print	Prints the active report without going to " Print Report " in the file menu
Previous Page	Selects the previous page on the report for display
Next Page	Selects the next page on the report for display
Two Pages	Shows two report pages at once
Zoom Out	Makes the report larger on the screen
Zoom In	Makes the report smaller on the screen
Close	Closes the Print Report Preview

See Also

[Reports Overview](#)

[Print Report](#)

[Export Report](#)

Export Report



Select "Export Report" from the File menu or select  from the Custom Modbus Map toolbar. Export Report lets you export some reports as files in comma delimited (.csv) or tab delimited (.txt) format. The files contain the same data as shown in the printed report, just formatted differently. Exported reports can then be imported by other applications such as third party operator interface configurations.

Not all printable reports can be exported; choices are limited.

Click on the Icon on the toolbar and select a report from the drop-down menu that appears. Name the report and save it as .csv or .txt.

To change the default export file type, see Export Delimiter.

Exported Files have the following format for their Header sections.

Header	Example	Description
RevisionID:	0115.0030.0002.0002.0003	AAAA.BBBB.CCCC.DDDD.EEEE Where AAAA = Export ID: 0103 = IO Configuration Information Report 0106 = Variable and Signal Tag Information Report 0115 = Modbus Address Detailed Report 0116 = User Defined Modbus Registers Report 0117 = Signal Tag Report 0118 = Variable Report 0119 = Modbus Address Summary Report 0120 = All Function Block Modbus Addresses 5000 = Modbus Partition Registers Report 5500 = All Modbus Registers Report BBBB = Database Schema Number CCCC = Product type: 2 = HC950 3 = HC930 4 = HC970R 5 = HC970 DDDD = Platform type: 2 = HC900 series controllers EEEE = Feature Set: Schema database minor revisions
File Name:	HC900-C50 Rev 2.1x : jjpconfig1 C50_R2.1.cde	Device Type Device Revision: Configuration Filename
Controller Name:	JOE	Controller name assigned within the configuration
Title:	Joe's Furnace Control	Optional title or description for the configuration
Author:	Joe	Optional author or creator of the configuration
Created Date:	5/20/2005 13:09	Date when configuration file was first created
Modified Date:	5/30/2005 14:05	Date when configuration file was last modified and saved.
Report Title:	Modbus Address Detailed Report	Report title: IO Configuration Information Report Variable and Signal Tag Information Report Modbus Address Detailed Report User Defined Modbus Registers Report Signal Tag Report Variable Report

<u>Header</u>	<u>Example</u>	<u>Description</u>
		Modbus Address Summary Report All Function Block Modbus Addresses Modbus Partition Registers Report – Partition Name All Modbus Registers Report

This page has been intentionally left blank

Modbus Register Addresses

Modbus Map Overview

Overview

Modbus addressing is available in revision 2.0 and later.

In your controller's configuration certain parameters are each automatically assigned a Modbus address. These include certain types of function blocks (such as loops and set point programmers), signals and variables, among other items. Through their addresses these parameters can be accessed or displayed remotely, such as by a third-party operator interface. Collectively, these Modbus addresses and parameters are known as the Modbus map. You can use a predefined fixed map where common parameters are mapped out automatically at fixed addresses, or you can create a custom map for configurations rev. 4.0 or higher.

[Click here for details on fixed vs. custom map.](#)

Configure Modbus Map Method

Overview

Lets you select your preferred Modbus mapping method: fixed or custom.

Access

1. Edit menu.
2. Configure Modbus Map Method

Caution: If you change from custom map to fixed map you will lose all custom addresses, partitions, and quantities not found in the fixed map (>32 loops, >8 SP Programmers, etc.). If you accidentally switch from custom to fixed you can use the Undo feature on the main toolbar.

Fixed or custom map

There are two kinds of Modbus maps available: fixed or custom. Basically, the fixed and custom maps both can contain the same types of items but the custom map has more flexibility with those items' quantities, addresses and data types. The maps have these characteristics.

Fixed map	Custom map
The items that can be in the fixed map are limited to certain types of function blocks and other configuration data.	The items that can be in the custom map are limited to certain types of function blocks and other configuration data, same as fixed map.
Items are automatically assigned to the fixed map.	At the moment you switch from fixed to custom map mode, any items in your configuration maintain their addresses from the fixed map. However, once you are in custom map mode, if you add more items to your configuration they are not automatically added to the custom map, you must add them manually.
Each item type is grouped in a fixed address range of the map. For example, the address range designated for Loops is restricted to Loops only, it can not contain Setpoint Programmers.	You can create partitions with custom names and address ranges. Partitions can contain any item types, you can mix and match items if needed.

Modbus Register Addresses
Configure Modbus Map Method

Fixed map	Custom map
<p>Quantities of each item type are at a fixed maximum (such as 32 loops, 8 programmers). Good for smaller configurations or pre-4.0 configurations. If your configuration exceeds these maximums a message reminds you to consider switching to the custom map.</p>	<p>Quantities are limited only by the amount of free space in the map or partition. Use custom map when you need to access data from more than 32 loops, for example.</p>
<p>Every parameter of a function block is automatically added to the map. You don't need to specify which of the block's parameters are mapped, they're all there. For example, all of a PID block's 40-plus parameters are added to the map.</p>	<p>Lets you pick and choose which block parameters to add. For example, a PID block contains over 40 parameters. The fixed map adds them all; the custom map lets you add only the ones you need to access, thus freeing up more addresses for other parameters.</p> <p>You can create templates to apply to any or all function blocks of a type. For example, you can select 5 of a PID block's parameters then save them to a PID template. You can load that template into other PID blocks so they each address the same 5 parameters.</p>
<p>You can reorder items within a group, such as switching Loop 1 with Loop 10. You can assign signals and variables to a user-defined area of the map.</p>	<p>You can reorder items. More generally you can put any parameter at any address or at multiple addresses or partitions.</p>
<p>The fixed map has a fixed range (45057-46056) for assigning configured signal tags and variables to another data type, such as integer 16.</p>	<p>The custom map lets you assign any data type to any address (float 32, integer 16, etc.). A default data type is applied but can be changed.</p>
<p>The fixed map contains several gaps of unused (and unusable) addresses.</p>	<p>Since you can put any parameter at any address you can eliminate gaps of unused addresses, thus increasing the map's capacity.</p>
<p>The fixed map is the default map for all configurations. Unless and until you switch to the custom map, the fixed map is in use. Items are automatically added to the map when you access the map, up to the quantity limits (such as 32 loops, 8 programmers). The only items that are not automatically added are user-defined signals and variables.</p>	<p>Uses the fixed map as a starting point*. Any edits to the fixed map (such as reordered items within a group or user-defined signals and variables) are carried over when you switch to the custom map. The custom map's default partitions are based on the fixed map's groups.</p> <p>Conversely, if you switch from custom map to fixed map, any customized partitions or addresses are lost.</p> <p>*You can revert to this starting point at any time by using the Replace feature in the custom map.</p>

Modbus addressability of principal function blocks

Function Block	Category/Filter	Available in fixed map?	Available in custom map?
AGA8-Detail	AGAs	No	Yes
AGA8-Gross	AGAs	No	Yes
Alternator	Alternators	Yes	Yes
UDC Loop	Communications	No	Yes
UDC Loop2	Communications	No	Yes
XYR5000 Base Station	Communications	No	Yes
XYR5000 Transmitter	Communications	No	Yes
XYR6000 Transmitter	Communications	No	Yes
Calendar Event	Counters/Timers	No	Yes
Device Control	Device Controls	Yes	Yes
Hand Off Auto	Hand Off Autos	Yes	Yes
Four Selector Switch	Logic	No	Yes
Push Button	Logic	No	Yes
Auto Manual Bias	Loops	Yes	Yes
Carbon Loop	Loops	Yes	Yes
On Off Loop	Loops	Yes	Yes
PID Loop	Loops	Yes	Yes
Three Pos. Step Cont.	Loops	Yes	Yes
Set Point Programmer	Programmers	Yes	Yes
Ramp	Ramps	Yes	Yes
Set Point Scheduler	Schedulers	Yes	Yes
Sequencer	Sequencers	Yes	Yes
Stage	Stages	Yes	Yes
Position Proportional Output	NA	No	No
Peer-Peer	NA	No	No
Modbus Slave	NA	No	No
Modbus/TCP Slave	NA	No	No
XYR6000 Gateway	NA	No	No

Fixed Modbus Map

Overview

Certain items in your configuration are automatically assigned Modbus addresses in the fixed Modbus map. These items include signal tags, variables and principal function blocks like loops and setpoint programmers. (See page 267.) As each item is added to your configuration it is assigned to the first (lowest) available Modbus address within the range reserved for that item type. If you delete an item from your configuration it is removed from that Modbus address and that address becomes available for another item.

Also available is a range of 1000 addresses (45057 for assigning user-defined signal tags and variables to any address or multiple addresses. Within these 1000 addresses the data type of each signal tag or variable can be changed, for example, from float 32 to integer 16.

Access

To access the fixed Modbus register map to add or edit an address, select the main menu Edit item, Edit Fixed Modbus Register Map, or right-click on a configured signal, variable, or function block.

The following tabs are presented.

User Defined Signals and Variables Tab

Procedure for editing signal or variable addresses.

1. Select the type of signal or variable you want to choose from.

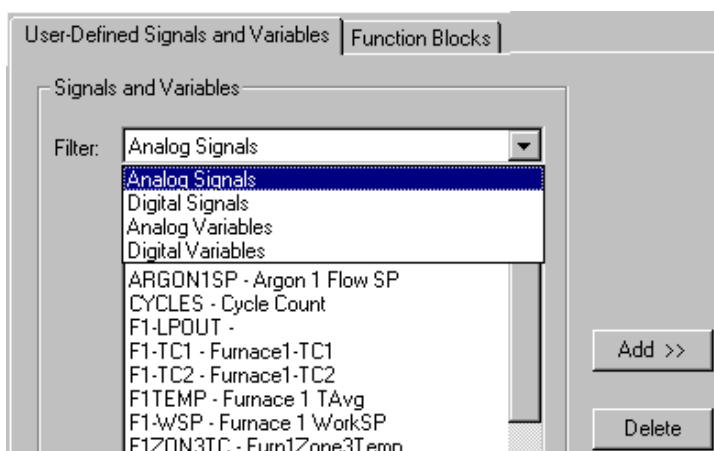

2. Highlight the desired signal/variable.
3. Select an address range you want to add to. There are 20 ranges of 50 addresses each for a total of 1000 addresses. Then click on the address you will assign the signal/variable to.

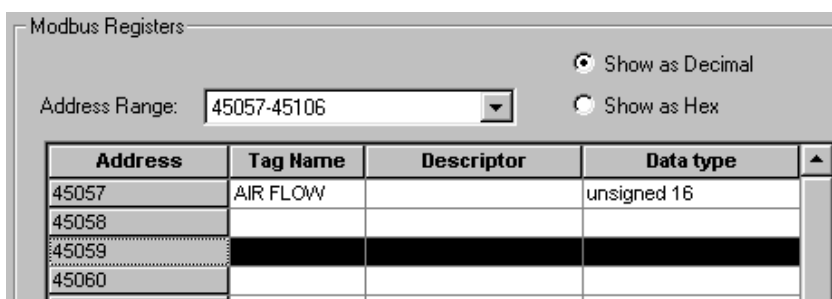

4. Click Add to insert the signal/variable.

- Click on the Data Type area of the signal/variable and select a data type. 32-bit data types require 2 adjacent addresses.

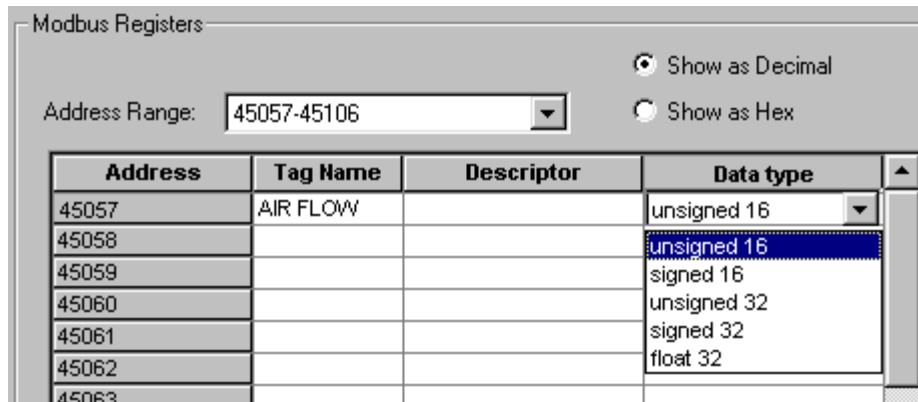

- You can assign a signal/variable to multiple addresses. Just repeat the preceding steps.
- To clear a single address, select it and click Delete. To clear all signal/variable addresses, select Clear All Registers. This does not clear the item's default address, it only clears the addresses assigned here.
- To view all addresses of an item, display its Properties.
Signal Tag Properties
Variable Properties

Function Blocks Tab

Procedure for editing function block addresses.

- Use Filter to list all configured function blocks of a certain type. Types whose Modbus address can be changed are:
 - Loops (PID, On-Off, Carbon Potential, 3 Position Step, Auto-Manual Bias)
 - Alternator
 - Hand/Off/Auto Switch
 - Sequencer
 - Setpoint Programmer
 - Setpoint Scheduler
 - Stage
 - Device Control
 - Ramp

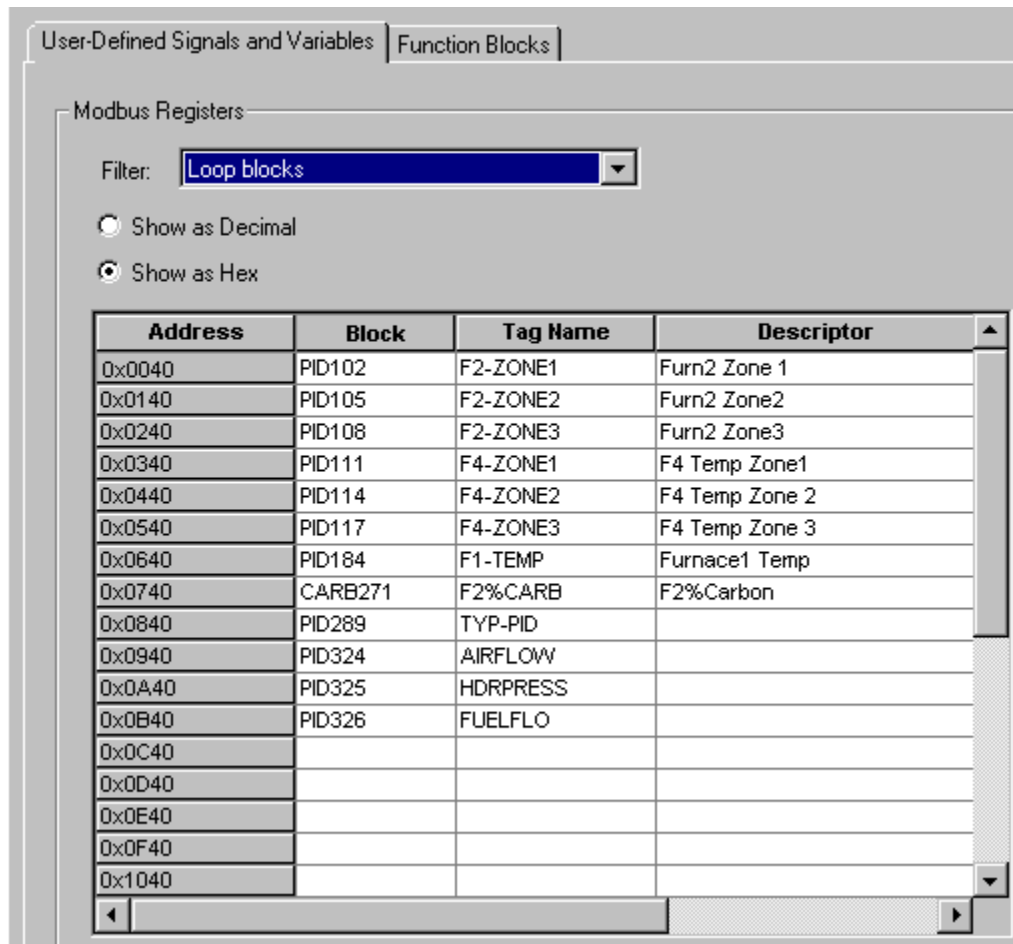

- Addresses containing that type of function block are shown in numerical order. For example, with the Loop blocks filter selected, Loop 1 starts at 0x0040/00065, Loop 2 starts at 0x0140/00321, etc. Whichever loop is in the first slot is known as Loop 1, as far as the Modbus map is concerned. That is, *loop order in the map is independent of execution order or block number. More generally, any function block's order in the Modbus map is independent of its execution order or block number.*
- To move a function block to another address, click on its address to select it, release, then click and drag it to the top of the new address, then drop it. A colored line appears while you're dragging the function block.
- If you drop it in an address that's occupied by another function block, the two function blocks will swap addresses.
- Unlike signals and variables, only one range of addresses is allowed per function block.
- To view the starting address of any function block, display its Properties by right-clicking on the function block in the configuration diagram under the Controller tab.

If your configuration contains more items than are allowed in the fixed map (such as >32 loops) a message informs you of this. Consider switching to the custom map, which allows for greater quantities and access to more parameters.

Further information

For details on Modbus parameters, see the HC900 Process Control Communications User Guide, document number 51-52-25-111.

Custom Modbus Map

Access

To access the custom Modbus register map to add or edit an address, click on the Modbus Map tab



at the bottom of the display. This tab is visible only after you configure your map type as custom.

Overview

The custom Modbus map is applicable to the array of Modbus registers classified as "holding registers" or "4xxxx" registers using decimal addressing where "xxxxx" equals the Modbus address ranging from 1-65535 decimal (0-FFFE hex).

Use the custom map to assign any addressable parameter (see page 267) to any address, along with its data type (float 32, integer 16, etc.). You can edit or create partitions of any size to help organize addresses.

Default partitions and addresses are based on the fixed map. This is only a default starting point; you can edit the custom map extensively or even erase it entirely and start from scratch.

To add an item to a map

1. Select a partition whose addresses you want to display or edit.
2. Assign items to the map in two ways: drag an item from the Configuration tab into an address, or click on an address under the Item heading and choose an item to add.
3. Select/edit item's parameters.

Working with partitions

You can view or edit addresses in defined partitions only. Addresses in undefined partitions are not available until you create a new partition with those addresses. Partitions need not be empty to be edited. If you need more addresses in a partition you can combine it with adjacent partitions, or resize it using space from an adjacent undefined partition. See Edit Partitions.

Functions



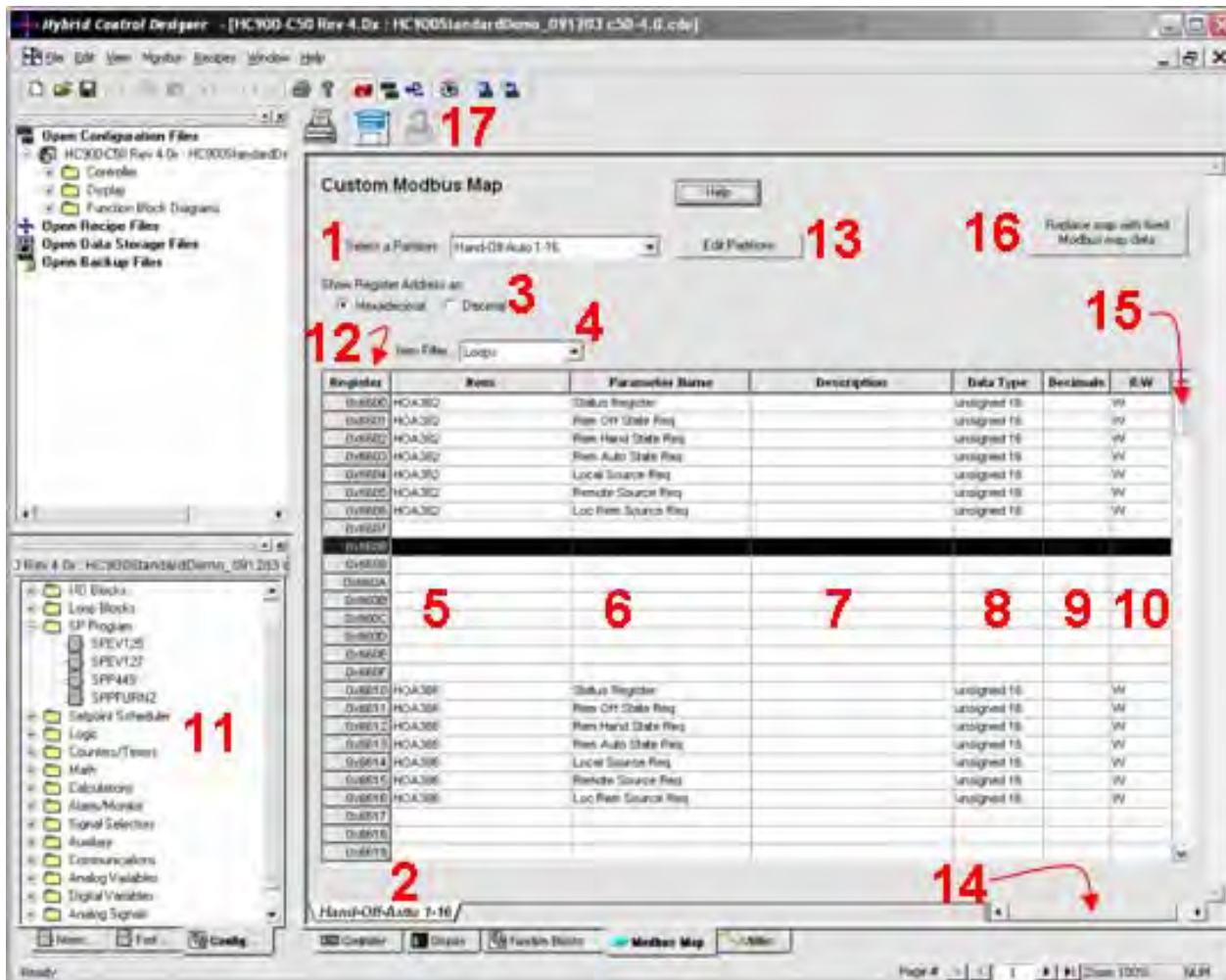

Refer to the following table for descriptions of the numbered items in the custom map. Functions are numbered in the order you will probably use them.



	Function	Description
1	Select a partition	You must select a partition whose contents you want to display or edit. The map takes a few seconds to build the contents. Default partitions are based on the fixed map and can be edited or resized. See Edit Partitions.
2	Currently displayed partition	Name of the current partition. See Select a partition.
3	Show Register Address as	Select whether to display addresses in hexadecimal or decimal.
4	Item Filter	Select the type of item (block, signal tag, etc.) whose parameters you want to assign to the map. Items of this type will then be listed as choices under the Item column. For example, if you select Loops then all your configuration's loop blocks will be listed under the Item column when you click there.

	Function	Description
5	Item	<p>Click on any address under the Item column. All items of the Item Filter type will be listed. (If no items of the filter type are in your configuration the list will be empty.) Click the item you want to add to the address.</p> <p>If you are adding a function block it will display a checklist of parameters from which to choose. Click here for details.</p> <p>If you are adding system parameters you must add them by clicking an address; they can't be dragged from the Configuration tab.</p>
6	Parameter Name	<p>If the item is a function block this is the parameter name. Click on this field to see a list of that item's other parameters from which to choose, if reassignment is desired.</p> <p>If the item is a signal tag or variable this is the tag name. Click to see a list of other signal tags or variables from which to choose.</p> <p>ATTENTION: when you assign a different parameter here, the Data Type does not automatically change, you must manually change to the correct Data Type for the parameter.</p>
7	Description	Read only. Description of signal tag or variable.
8	Data Type	<p>Choices:</p> <ul style="list-style-type: none"> Unsigned 16 Signed 16 Unsigned 32 (requires 2 registers) Signed 32 (requires 2 registers) Float 32 (requires 2 registers) <p>If 2 registers are required the higher register is grayed out and not assignable.</p> <p>Note: For signals and variables, when changing data type from float 32 to integer 16, keep in mind the decimal point location. For example, 1000.1 translates to 10001.</p> <p>Note: For function blocks, when changing data type from float 32 to integer 16, the value is rounded. For example, 1000.1 translates to 1000 and 1000.5 translates to 1001.</p>
9	Decimals	Read only. Decimal places of signal tag or variable.
10	R/W	<p>Type of access to the parameter.</p> <ul style="list-style-type: none"> Read Write Read/Write
11	Configuration Tab	This tab shows all configured items. Click and drag an item from here to an address under the map's Item column. Not all items can be assigned to an address. Dragging a function block will display its checklist of parameters from which to choose. Click here for details.

	Function	Description
12	Register	<p>Click on a register(s) then right click for the menu.</p> <p>Clear Contents – deletes the contents of the selected registers without affecting other registers.</p> <p>Insert Registers – Inserts blank registers before the selected registers and shifts registers down by the same amount. Will not work if partition's last registers are occupied.</p> <p>Delete Registers – deletes the contents of the selected registers and shifts subsequent registers up by the same amount.</p> <p>Cut – cuts contents of registers</p> <p>Copy – copies contents of registers</p> <p>Paste – pastes from the last cut or copy</p>
13	Edit Partitions	<p>A register must be in a defined partition in order to be populated with data, you can't assign data to an undefined partition.</p> <p>Default partitions are based on the fixed map. An undefined partition starts where the fixed Modbus map ends.</p> <p>Partitions can be edited in the following ways.</p> <p>To rename a partition, click on the Description and enter a new name.</p> <p>To edit one or more partitions, click on one or more partition # then right-click to access these functions:</p> <p>Clear - deletes the contents of the selected partitions but keeps the partition names and addresses.</p> <p>Delete - deletes the contents of the selected partitions as well as the partition names and addresses, leaving behind an undefined partition which does not appear in any exports or reports.</p> <p>Split - divides the selected partition into two contiguous partitions of any size and names you specify. Does not delete contents of the partition's registers. You can split undefined partitions.</p> <p>Combine - merges selected partitions into one partition of any name. Does not delete the contents of the partition's registers. You can combine undefined partitions.</p> <p>Resize - changes the starting and ending address of the selected partition.</p> <p>New - Creates a new partition within an undefined partition.</p> <p>To erase the entire map and start from scratch, select all partitions and select Delete, then select all undefined partitions and select Combine.</p>
14	Horizontal Scroll	Use to scroll to offscreen areas of the map.
15	Vertical Scroll	Lets you scroll through the partition.

	Function	Description
16	Replace map with fixed Modbus map data	<p>Replaces the entire custom map with all your configuration's loops, programmers, etc. at their preassigned addresses and partitions, up to the fixed map's quantity limits (e.g., 32 Loops, 8 SP Programmers, etc.). Beyond these quantity limits items will not be added to the map unless you add them manually. Since you are still in custom map mode, you can edit the map after doing the replacement.</p> <p>ATTENTION: Do not select Replace unless you are willing to overwrite your entire custom map's registers and partitions. Consider backing up your custom map first, either by saving a backup of your configuration or by Exporting a Modbus report. Or you can click on the Undo button in the main toolbar.</p>
17	Toolbar	<div style="display: flex; flex-direction: column; align-items: flex-start;"> <div style="display: flex; align-items: center; margin-bottom: 10px;">  <p>Prints a Partition Report.</p> </div> <div style="display: flex; align-items: center; margin-bottom: 10px;">  <p>Exports a Partition Report.</p> </div> <div style="display: flex; align-items: center;"> <div style="display: flex; margin-right: 10px;">   </div> <p>Lock/unlock Worksheet</p> </div> </div>

Further information

For details on Modbus parameters, see the HC900 Process Control Communications User Guide, document number 51-52-25-111.

Adding function block parameters to custom map

Two methods to add parameters to the map

Method 1: In the Configuration tab in the Worksheet Toolbox window, click and drag a function block over to a starting address register in the custom map.

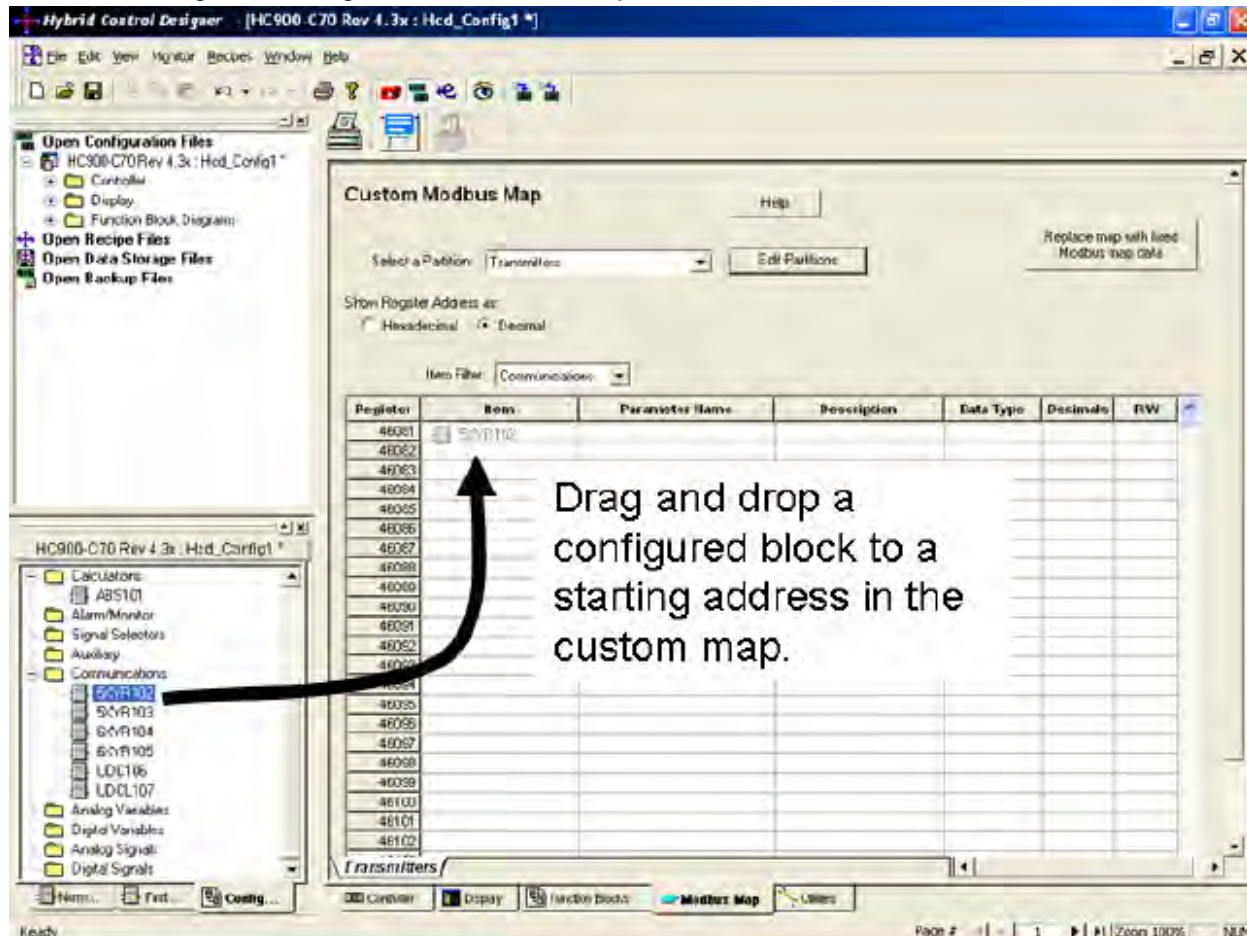

Method 2: In the custom map, select an Item Filter, then click on a starting address in the Item column.
Note: If adding system register parameters you must use this method.

Modbus Register Addresses
Adding function block parameters to custom map

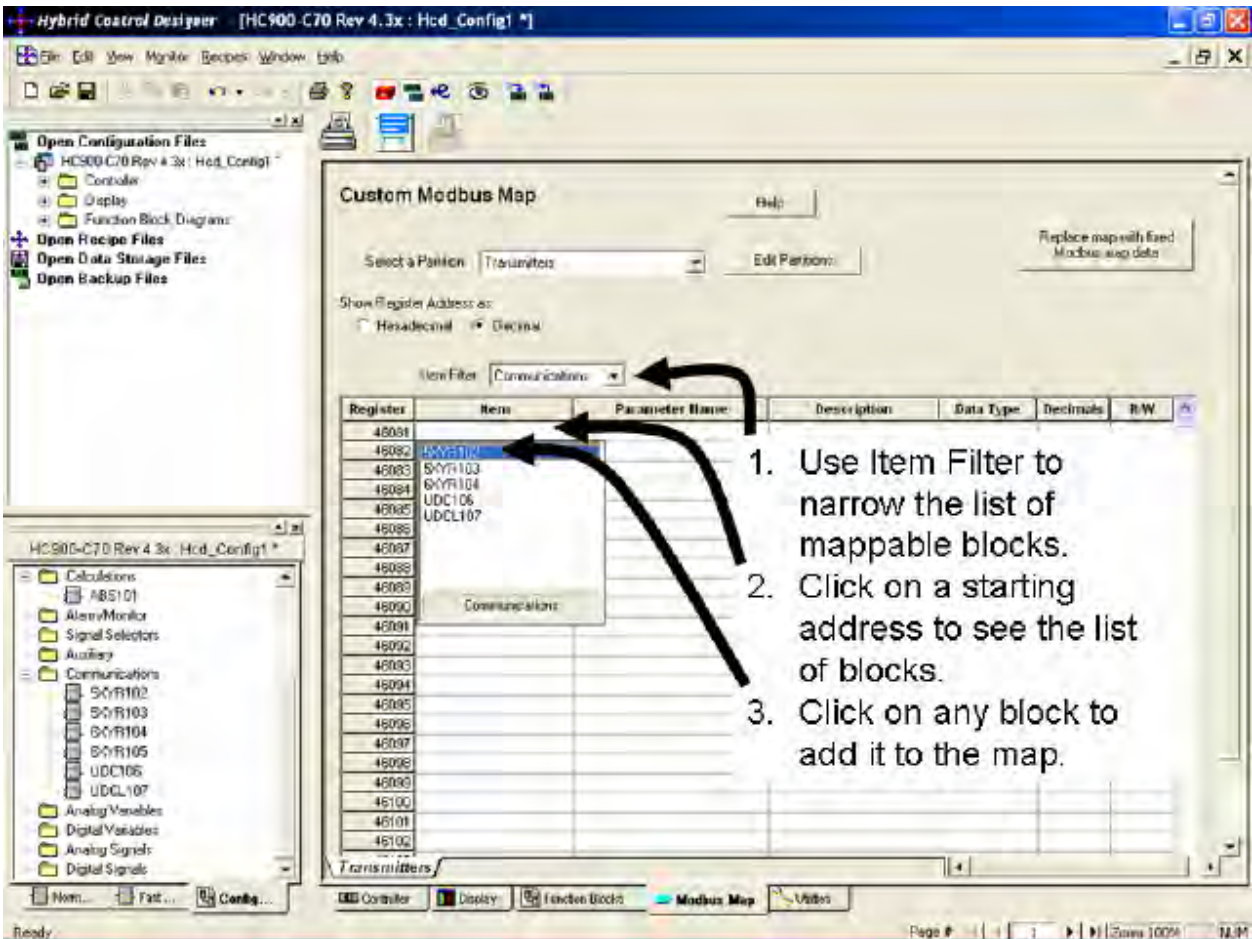

In both methods the following box appears listing all available parameters for the block type selected.

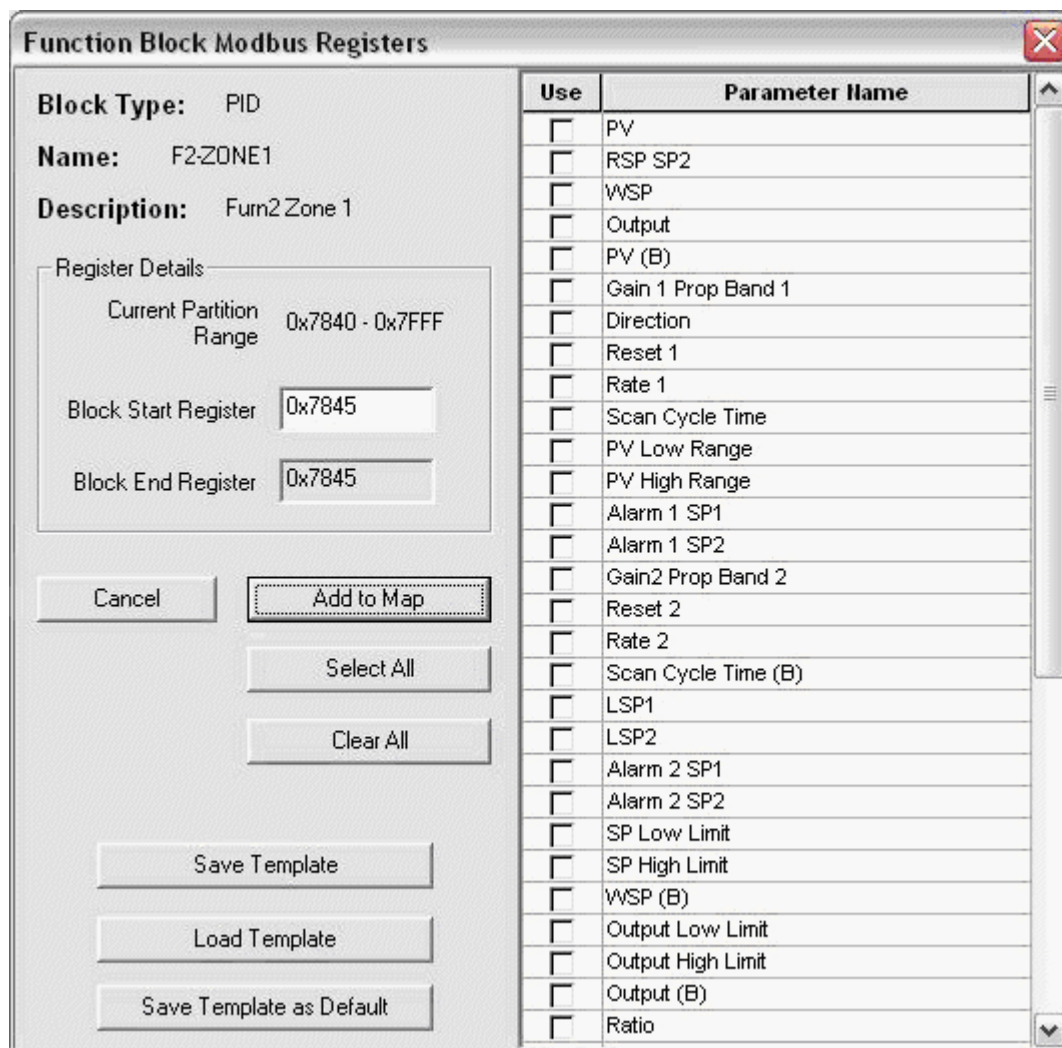

Function blocks that can be added to the custom map

Functions

Use this window to select block parameters to add to your custom map.

The available block parameters for the selected block will be listed. Select the parameters you'd like to add by using **Select All**, **Clear All**, or by checking and unchecking individual parameters.

Click **Add to Map** to add the checked parameters to the map. The uppermost checked parameter will be added to the **Block Start Register**, and the remaining checked parameters will contiguously fill in the remaining registers until the **Block End Register** is reached. Unchecked parameters will not leave gaps in registers, in most cases. If the current partition range is not big enough to hold all the parameters you must select fewer parameters or edit the partition to make it larger.

You can use templates to apply the same list of parameters to each function block of that type. This saves you the effort of creating the same checklist for each block and ensures the same parameters are checked. Templates are saved as separate files with **.ptf** extension. Each block type is limited to templates created for that block type only. You can't apply a PID block's template to a Setpoint Programmer block, for example.

Example of how to use templates

1. Add a PID loop to the map. We'll refer to this as PID 1.
2. Check PID 1's desired parameters to be addressed.
3. Click **Save Template** to save this checked list to a template file (extension .ptf). Use a descriptive filename that describes the type of block, for future reference. For example, PID1.ptf.
4. As you add other PID loops to the map you can **Load Template** PID1 into them, which applies the same checklist of parameters.
5. You can also **Save Template As Default** for that block type, which saves you from loading a template into each block. For example, if you want all your PID blocks to have the same parameters checked as the template PID1, save PID1 as the default. When you add subsequent PID blocks to the map they will automatically have those same parameters checked.

Adding system parameters to custom map

Overview

If adding system register parameters to the custom map you must click on an address to add them. They can not be dragged from the Configuration tab.

Procedure

1. Select Item Filter "System Register."
2. Click on an address under Item.
3. Select a system parameter.
4. If adding time parameters you must add all time parameters to the map, one at a time. Time parameters must be written to as a group, therefore you must add all* of them to the map.

*The Day-of-week parameter is optional and can be left out.

This page has been intentionally left blank

Redundancy

C70R/C75 controllers/networks have their own diagnostics that are accessed under

[Utilities Worksheet Overview](#)

[Monitor Menu](#)

Redundancy diagnostics are grouped as follows.

[Redundancy System](#)

[Redundancy Link](#)

[Lead CPU](#)

[Reserve CPU](#)

[Scanner 2 Link](#)

Redundancy System Status Indicators

The Redundancy System Diagnostics dialog box will provide status of the parameters shown in the following list.

Parameter	Value	Possible Cause	Controller Action	User Action
Redundancy Status	Available	Normal operation	N/A	N/A
	No RSM module detected	Switch on RSM is set between two positions. RSM Module is not inserted RSM Module has failed	The controller will continue to operate with a missing RSM. Automatic failover is still possible if required.	Make sure switch is in desired position Install RSM module Replace RSM
	RSM switch is bad	RSM Switch is indicating an invalid position	The controller will continue to operate with a bad RSM. Automatic failover is still possible if required.	Replace RSM
	I/O comm error on reserve	Reserve CPU is unable to communicate with one or more of the I/O racks.	The lead controller will continue to control the process. Failover to the reserve is still possible if a subsequent failure renders the current lead less capable than the reserve.	Verify all cabling between the reserve CPU and the scanners. Replace any Ethernet switches between the reserve CPU and the I/O rack(s). Replace the reserve CPU Replace the scanner CPU Contact Honeywell service
	Database Not Synchronized	Hardware failure on the reserve CPU Hardware failure on the lead CPU Hardware failure on the CPU rack backplane	The lead controller will continue to control the process, but failover is not possible.	Replace the reserve CPU Replace the lead CPU Replace the CPU rack backplane Contact Honeywell

Redundancy
Redundancy Link Status Indicators

Parameter	Value	Possible Cause	Controller Action	User Action
				service
	Invalid Configuration	Neither CPU has a valid configuration database	An empty database is created.	Download the desired configuration file and perform a cold start.
	Firmware Version Mismatch	The reserve controller does not have the same version of controller firmware installed	The lead controller will continue to control the process, but failover is not possible.	Upgrade the CPU firmware so both the lead and reserve have the same version.
Redundancy Diagnostics	Good			
	Database Not Synchronized	Hardware failure on the reserve CPU Hardware failure on the lead CPU Hardware failure on the CPU rack backplane	The lead controller will continue to control the process, but failover is not possible.	Replace the reserve CPU Replace the lead CPU Replace the CPU rack backplane Contact Honeywell service
	Invalid Configuration	Neither CPU has a valid configuration database	An empty database is created.	Download the desired configuration file and perform a cold start.
	Firmware Version Mismatch	The reserve controller does not have the same version of controller firmware installed	The lead controller will continue to control the process, but failover is not possible.	Upgrade the CPU firmware so both the lead and reserve have the same version.

Redundancy Link Status Indicators

The Redundancy Link Diagnostics dialog box will provide status of the parameters shown in the following list.

Parameter	Value	Possible Cause	Controller Action	User Action
Redundancy Link Port Status	Good	Lead and Reserve CPUs working ok	N/A	N/A
	Reserve not present	Reserve CPU module is not plugged in.	N/A	Install Reserve CPU
	Reserve Bad Comm	Reserve CPU module is plugged in but not communicating.	Reserve or Lead CPU module could be bad. Backplane could be bad.	Replace faulty CPU. Replace rack.
	Hardware failure	Bad Lead module Bad backplane	N/A	Replace faulty CPU. Replace rack.
Redundancy Link	Good	N/A	N/A	N/A

Parameter	Value	Possible Cause	Controller Action	User Action
Port Diagnostics	Data Link Failure	Reserve CPU module is not plugged in. Reserve CPU module is plugged in but not communicating.	The lead CPU will continue to control the process but failover is not possible.	Replace faulty CPU Replace rack
	Hardware Failure	Bad Redundancy link hardware detected on the lead CPU	The lead CPU will continue to control the process but failover is not possible.	Replace faulty CPU

Lead CPU Status Indicators

The Lead Diagnostics Overview dialog box will provide status of the parameters shown in the following list. These parameters are also shown for the Reserve Diagnostics Overview.

Parameter	Status	Possible Cause	Controller Action	User Action
CPU Diagnostics	Good	N/A	N/A	N/A
	Watchdog	Watchdog reset resulting from software failure	ASYS block's HW OK pin is turned off.	<ol style="list-style-type: none"> 1. Force a cold start. 2. Upgrade control file software. 3. Replace CPU board. 4. Contact Honeywell Personnel.
	Prefetch Abort	CPU failed when attempting to fetch an instruction from the prefetch register.	<ol style="list-style-type: none"> 1. Controller performs a restart 2. ASYS block's HW OK pin is turned off. 	<ol style="list-style-type: none"> 1. Force a cold start. 2. Isolate system from noise and force a cold start. 3. Replace CPU board
	Address Error	The reserved exception occurred for an unknown reason.	Same as above	Same as above
	Undefine Error	Bad Instruction Detected	Same as above	Same as above
	Data Abort	CPU failed when attempting to access data.	Same as above	Same as above
	Software Interrupt Error	Software Interrupt occurred which is not supported by the software.	Same as above	Same as above
	Good	N/A	N/A	N/A

Redundancy
Lead CPU Status Indicators

Parameter	Status	Possible Cause	Controller Action	User Action
	Watchdog	Watchdog reset resulting from software failure	ASYS block's HW OK pin is turned off.	<ol style="list-style-type: none"> 1. Force a cold start. 2. Upgrade control file software. 3. Replace CPU board. 4. Contact Honeywell Personnel.
Memory Diagnostics	Good	N/A	N/A	N/A
	5 Day Low Battery Warning	Estimated battery life is less than 5 days.	ASYS block's HW OK pin is turned off.	Replace battery.
	Low Battery	Battery voltage is low.	<ol style="list-style-type: none"> 1. ASYS block's LOW BATTERY pin is turned on. 2. ASYS block's HW OK pin is turned off. 	Replace battery.
	Flash Error	Flash failed to burn	ASYS block's HW OK pin is turned off.	<ol style="list-style-type: none"> 1. Force a cold start. 2. Replace CPU board.
Real-time Clock Diagnostics	Good	N/A	N/A	N/A
	Not Programmed	RTC not programmed	<ol style="list-style-type: none"> 1. Time and date is set to 00:00:00, January 1, 1970. 2. ASYS block's HW OK pin is turned off. 	<u>Program RTC.</u>
	Bad Data	Bad date and time	Same as above	<ol style="list-style-type: none"> 1. <u>Program RTC.</u> 2. Cycle power. 3. Replace CPU. 4. Replace boards in rack. 5. Replace rack
	Programming Failure	RTC failed to program	Same as above	Same as above
	Read Failure	Unable to read RTC	Same as above	Same as above
Port S1/S2 Diagnostic	Good	N/A	N/A	N/A

Parameter	Status	Possible Cause	Controller Action	User Action
	Data Link Error	A large number of messages are resulting in data link errors.	SYSTEM MONITOR block's HW OK pin is turned off.	<ol style="list-style-type: none"> 1. Check baud rate. 2. Check connectors. 3. Check cable polarity. 4. Isolate cable from electrical interference. 5. If RS232-to-RS485 converter used, check its power, switch/jumper settings, and polarity.
	Hardware Failure	The UART is failing to operate properly.		Replace the controller CPU module.
Lead Port E1/E2: Network Port Diagnostics	Good	N/A	N/A	N/A
	Hardware Failure	Ethernet port tests failed during power-up.	Same as above	Replace CPU module
Rack Comm Diagnostic	Good	See Expansion I/O Comm Diagnostics Status Indicators		
	Data Link Failure	See Expansion I/O Comm Diagnostics Status Indicators		
	Hardware Failure	See Expansion I/O Comm Diagnostics Status Indicators		
	Port A/B Cable Mismatch	See Expansion I/O Comm Diagnostics Status Indicators		
	Protocol Mismatch	See Expansion I/O Comm Diagnostics Status Indicators		
Scanner2 Rack n Network Status	No Comm	See Scanner 2 Link Status Indicators .		
	Marginal - Port I/O A	See Scanner 2 Link Status Indicators .		
	Marginal - Port I/O B	See Scanner 2 Link Status Indicators .		
	Good - Port I/O A	See Scanner 2 Link Status Indicators .		
	Good - Port I/O B	See Scanner 2 Link Status Indicators .		

Redundancy
Reserve CPU Status Indicators

Parameter	Status	Possible Cause	Controller Action	User Action
	Not in Configuration	See Scanner 2 Link Status Indicators .		
Scanner2 Rack n Network Diagnostics	Good	See Scanner 2 Link Status Indicators .		
	Data Link Failure	See Scanner 2 Link Status Indicators .		
	Hardware Failure	See Scanner 2 Link Status Indicators .		
	Port A/B Cable Mismatch	See Scanner 2 Link Status Indicators .		
	Protocol Mismatch	See Scanner 2 Link Status Indicators .		
CPU Slot Position	CPU A	CPU A is the Lead/Reserve.	N/A	N/A
	CPU B	CPU B is the Lead/Reserve.	N/A	N/A
	CPU is missing	Reserve CPU is not installed or not powered. CPU rack backplane failure.	The lead CPU will continue to control the process but failover is not possible.	1. Install reserve CPU. 2. Apply power to reserve CPU. 3. Replace CPU rack backplane. 4. Call Honeywell service.
Power Supply Type	Unknown	CPU cannot identify the Power Supply Type	None	None
	24VDC	CPU identified a 24VD DC power supply	None	None
	Low Wattage	CPU identified a Low wattage power supply	None	None
	High Wattage	CPU identified a High wattage power supply	None	None

Reserve CPU Status Indicators

Contains same information as for the [Lead CPU Status Indicators](#).

Scanner 2 Link Status Indicators

The Redundancy Scanner 2 Link Diagnostics dialog box will provide status of the parameters shown in the following list.

Parameter	Value	Possible Cause	Controller Action	User Action
Scanner-2 Network Status	No Comm	C70R/C75 is communicating to none of the Scanner 2s that are in the configuration. or C70R/C75 may be communicating to a Scanner 2 that is not in the configuration	If scanners are in the configuration, see Expansion Rack Link Diagnostics below.	See Expansion Rack Link Diagnostic below.
	Marginal - Port I/O A	C70R/C75 is experiencing marginal communications on the respective Scanner 2 link to one or more Scanner 2s in the configuration and/or C70R/C75 is communicating to some of the Scanner 2s in the configuration but not all	If a scanner 2 in the configuration is not communicating, then a communication diagnostic is posted for that rack. Refer to the Expansion I/O Comm Diagnostic Summary dialog box	Refer to the Expansion I/O Comm Diagnostic Summary dialog box
	Marginal - Port I/O B	C70R/C75 is experiencing marginal communications on the respective Scanner 2 link to one or more Scanner 2s in the configuration and/or C70R/C75 is communicating to some of the Scanner 2s in the configuration but not all	Same as above	Same as above
	Good - Port I/O A	C70R/C75 is experiencing good communications on the respective Scanner 2 link. Scanner 2s not in the configuration have no effect on the status	Lead CPU is operating normally using the I/O Port A to communicate with the Scanner Racks	none
	Good - Port I/O B	C70R/C75 is experiencing good communications on the respective	Lead CPU is operating normally using the I/O Port B to communicate with the Scanner Racks	none

Redundancy
Scanner 2 Link Status Indicators

Parameter	Value	Possible Cause	Controller Action	User Action
		Scanner 2 link. Scanner 2s not in the configuration have no effect on the status		
	Not in Configuration	No Scanner 2s in the configuration	N/A	N/A
Expansion Rack Link Diagnostics	Good		N/A	N/A
	Data Link Failure	The ratio of the number of data link errors and the number of good messages exceeds a certain threshold	See the "Rack Comm Diagnostics" parameter in the <u>Expansion I/O Comm Diagnostic Summary</u> dialog box	See the "Rack Comm Diagnostics" parameter in the <u>Expansion I/O Comm Diagnostic Summary</u> dialog box
	Hardware Failure	The expansion I/O port's hardware is indicating a failure	See the "Rack Comm Diagnostics" parameter in the <u>Expansion I/O Comm Diagnostic Summary</u> dialog box	See the "Rack Comm Diagnostics" parameter in the <u>Expansion I/O Comm Diagnostic Summary</u> dialog box
	Port A/B Cable Mismatch	At least one Scanner 2 has its A and B ports swapped with the Lead and Reserve	See the "Rack Comm Diagnostics" parameter in the <u>Expansion I/O Comm Diagnostic Summary</u> dialog box	See the "Rack Comm Diagnostics" parameter in the <u>Expansion I/O Comm Diagnostic Summary</u> dialog box

Index

A		Create/edit Data Storage File	83
Accessing Port Diagnostics	221	Create/edit Recipe-Variables-File	164
Adding a Numeric Constant	115	Create/edit Schedule file	171
Adding a Variable	114	Create/edit Sequence File	176
Adding function block parameters to custom map	255	Create/edit Setpoint Profile File	167
Adding system parameters to custom map	258	Custom Modbus Map	250
Alarm Details	69, 101	Cut	20, 28, 89
Alarm Group Configuration	100	D	
Alarm/Event Storage Configuration and	125	Data Storage Configuration	83
Auto Calibration Procedure	149	Data Storage Configuration Access	83
B		Data Storage Conventions	77
Backup Controller Information	141	Data Storage Enable Conditions	79
Batch File Management	160	Data Storage File	83
Before you Start	109	Data Storage Overview	77
C		Data Storage Utility	140
Calibrate AI Channel	146	Default Annotation Attributes	125
Calibrate AO Channel	147	Changing	125
Calibrate CJ Temp	146	Diagnostics	
Calibrate Modules	145	configuration port	222, 223
Calibrate Position Proportional Output	148	controller	205, 207
Changing the Default Annotation Attributes.	125	expansion I/O comm	228, 229
Closing a Menu	17	host connections	231, 232
Communications Statistics	55	I/O module	217
Configuration File	31, 127	Modbus Initiator TCP Port Diagnostics	237
Saving	31, 127	Modbus Master Serial Port Diagnostics	234
Configuration Functions	162	network port	226, 227
Configuration Overview	155	peer to peer	238, 239
Configuration Port Diagnostics	222	port	221
Configuration Port Diagnostics Status Indicators	223	rack	213
Configure Modbus Map Method	244	RS485 OI port	225
Configuring Display Tag Groups	65	Display Buttons Configuration	63
Connecting the PC to the Controller	8	Display Tag groups	65
Connecting/Disconnecting Blocks	112	Displaying Function Block Pin Value	195
Connectors	194	Download Setpoint Profiles	163
Context Sensitive Help	125	using recipe to download	163
Control strategy	109	Downloading a File to the Controller	40
Controller Configuration Overview	59	Drag and Drop	125
Controller Configuration Toolbar	60	E	
Controller Diagnostics	205	Edit Menu	20
Controller Diagnostics Status Indications	207	Edit Schedule Segments	176
Controller Identification	135	Edit Setpoint Schedule	176
Controller Port Diagnostics	223	E-Mail Notification	61, 71, 104
Controller to PC Connection Settings	53	Enter Monitor Mode	184
Controller Utility Functions	129	Event Details	71, 103
Controller Worksheet Overview	59	Event List Configuration	70, 102
Converting a UMC800 Database	36	Execution Order	103
Copy	20, 89	Expansion Port Diagnostics	228
		Expansion Port Diagnostics Status Indicators	229
		Export Delimiter	20
		Export Report	242

F	
Fast Logic Indicator	108
Fast Scan Indicator	108
FB Worksheet Overview	89
FBD Configuration Toolbar	89
FBD Worksheet Properties	97
how to change	97
File Browser Window	11
File Menu	18
File Properties	44
File Protection	48
File Read Protection	48
Find Feature	199
Find Where Used	28
Finding a Tag Name	199
Finding an Item on the FBD Worksheet	199
Fixed Modbus Map	244, 247
Forced Blocks Window	191
Forcing/Unforcing an Output	188
Function block	105, 107, 126, 195
accessing details	126
how to display pin value	195
inputs and outputs	105
Types	107
Function Block	110
adding, moving, deleting	110
Function Block Address	126
Function Block Definition	105
Function Block Diagram Configuration Toolbar	89
Function Block Diagram Rules	127
Function Block Diagrams	127
Function Block Identification	105
Function Block Monitor Window	187
Function Block Parameters	126
Function Block Usage Guidelines	108
Function blocks	112
connect/disconnect	112
G	
General Designer Window Terminology	10
General Steps to Build a Control Strategy	109
General Terminology	10
General Windows Terminology	10
H	
Hand Calibration Procedure	151
Hardware and Software requirements	4
Help Menu	25
Host Connections Diagnostics	231
Host Connections Diagnostics Status Indicators	232
How Do I Start Monitoring	185
How Do I Stop Monitoring	192
How to Add a New FBD Worksheet	90
How to Add a New Worksheet	90
How to Add Worksheet Protection	44, 98
How to Change A FBD Worksheet Properties	97
How to Change the Worksheet Order	97
How to Delete a FBD Worksheet	97
How to Find an Item on the FBD Worksheet	96
How to Manage PC Comm Ports and Connections	49
How to Navigate Between FBD Worksheets	91
Designer Main Menus	17
I	
I/O Module Diagnostics Status Indications	217
K	
Keyboard Navigation	30, 92
L	
Logic Inversion Color Codes	196
M	
Main Menu	17
Main Menus	17
Main Toolbar Functions	26
Manually Write Database to Flash	144
Menu	16, 17
Closing	17
Selecting	17
Menu Conventions	16
Message Display Configuration	75
Modbus Address	247
Adding function block parameters to custom map	255
Adding system parameters to custom map	258
choosing fixed or custom map	244
Custom Modbus Map	250
Fixed Modbus Map	247
Modbus Map Overview	244
Modbus Initiator TCP Port Diagnostics	237
Modbus Master Serial Port Diagnostics	234
Monitor menu	23
Monitor Mode	184
indicator	184
Monitor Toolbar	184
Monitor Update Rate	184
Monitoring	181, 185, 192
how to start	185
how to stop	192

N		R	
Navigational Tools	28	Rack Module and Channel Assignments	4
Network Port Diagnostic Status Indicators	227	Rack Diagnostics	213
Network Port Diagnostics	226	Rack Diagnostics Power Supply	216
Numeric Constant	115	Recipe	166
Adding	115	Setup/Edit	166
O		Recipe Configuration Overview	162
O/I File Names for Disk Storage	74	Recipe Overview	160
Operator Interface Displays	63	Recipe Pool	165
Operator Interface Settings	72	Recipe Properties	166
Operator Panel Configuration Toolbar Test	62	Recipes Menu	24, 161
Operator Panel Worksheet Overview	62	Recipe-Variables	162
Output	188	configuration overview	162
Forcing/Unforcing	188	Recipe-Variables- File	164
Overview	192	Recipe-Variables-Overview	162
Logic Flow	192	Redo	20
Overview On Line Monitoring	181	Remote Access	54
P		Remote Loopback Test	53
Page connectors	194	Report	239, 241, 242
Page Connectors	121	Export	242
Paste	20, 28, 89	Preview	241
PC Comm ports and connection	49	Print	239
how to manage	49	Resolve Dangling Soft Wires	94
PC Network Port Set Up For Controller Access	49	Restore Controller Information	142
PC Serial Com Port Setup	51	Restore Factory Calibration	148
PC to Controller Connection Settings	53	Right Mouse Click	28
Peer-to-Peer Connections Diagnostics	238, 239	RS485 OI Port Diagnostics	225
Peer-to-Peer Connections Diagnostics Status Indicators	238, 239	RS485 OI Port status Indicators	225
Pin Value	195	S	
placePlaceNameModbus PlaceNameInitiator		Saving A Configuration File	31, 127
PlaceNameTCP PlaceTypePort Diagnostics	237	Saving A Function Block Diagram	31, 127
placePlaceNameModbus PlaceNameMaster		Select the Number to Call	54
PlaceNameSerial PlaceTypePort Diagnostics	234	Selecting a Menu	17
Point Log Storage Configuration	85	Semi-Auto Calibration Procedure	150
Position Proportional Output Calibration	148	Sequence	178
PPO Block Auto Calibration	149	setup/edit	178
PPO Block Calibration	148	Sequence File	176
PPO Block Hand Calibration	151	Sequence Pool	178
PPO Block Semi-Auto Calibration	150	Sequence Properties	180
Print Report	239	Sequencer Configuration Overview	159
Print Report Preview	241	Serial ports	131
		set controller serial ports	131
		Set Controller IP Address	134
		Set Controller Mode	134
		Set Controller Network Parameters	134
		Set Controller Time	137
		Set Instrument Time	137
		Set Serial Port	131
		Setpoint Profile	167, 169
		properties	169
		Setpoint Profile Pool	168
		Setpoint Profile Properties	169
		Setpoint Program	154, 155

Index

Scanner 2 Link Status Indicators

configuration	155	User Assigned Tag Names	126
What is	154	User Interface Overview	9
Setpoint Schedule	176	Using Recipes to Download Setpoint Profiles	163
setup/edit	176	Utilities Worksheet Overview	129
Setpoint Schedule File	171		
Setpoint Schedule Overview	158	V	
Setpoint Schedule Pool	176	Variables	114
Setpoint Schedule Properties	176	Adding	114
SETPT	126	View Menu	22
Setup/Edit a Recipe	166	Visual Indicators for Monitor Mode	184
Setup/Edit Sequence	178		
Signal	119	W	
Signal Tags	119, 194	Watch Summary - Display Groups	203
Software Overview	1	Watch Summary - Inputs/Outputs	202
Sort Function	199	Watch Summary - Page Connectors	201
Start Up Display Configuration	74	Watch Summary - Signals	201
Starting the Application	7	Watch Summary - User Defined	199
Status Bar	16	Watch Summary - Variables	202
system parameters	250, 258	Watch Summary Window	14
		Watch Window	13, 93
T		What is Sequence Control	159
Tag Order	104	What is Sequence Control?	159
templates	255	Window Menu	25
Terms and Definitions	153	Wire Nodes	117
Traceback Window	13, 93	Worksheet	44, 57, 61, 75, 91, 98, 104
Trend Storage Configuration	84	How to add protection	44, 98
Types of Blocks	107	how to navigate	91
		unlock	61, 75, 104
U		What is	57
UMC800 Database	36	Worksheet Category Tabs	57
Converting	36	Worksheet Overview	62, 89, 129
Undo	20	Worksheet Toolbox Window	12
Unforcing an Output	188	Write Protect a File	48
Unlock the Worksheet	61, 75, 104		

Sales and Service

For application assistance, current specifications, pricing, or name of the nearest Authorized Distributor, contact one of the offices below.

ASIA PACIFIC

Honeywell Process Solutions,
(TAC) hfs-tac-support@honeywell.com

Australia

Honeywell Limited
Phone: +(61) 7-3846 1255
FAX: +(61) 7-3840 6481
Toll Free 1300-36-39-36
Toll Free Fax:
1300-36-04-70

China – PRC - Shanghai

Honeywell China Inc.
Phone: (86-21) 5257-4568
Fax: (86-21) 6237-2826

Singapore

Honeywell Pte Ltd.
Phone: +(65) 6580 3278
Fax: +(65) 6445-3033

South Korea

Honeywell Korea Co Ltd
Phone: +(822) 799 6114
Fax: +(822) 792 9015

EMEA

Honeywell Process Solutions,
Phone: + 80012026455 or
+44 (0)1344 656000

Email: (Sales)

FP-Sales-Apps@Honeywell.com

or

(TAC)

hfs-tac-support@honeywell.com

AMERICA'S

Honeywell Process Solutions,
Phone: (TAC) 1-800-423-9883 or
215/641-3610
(Sales) 1-800-343-0228

Email: (Sales)

FP-Sales-Apps@Honeywell.com

or

(TAC)

hfs-tac-support@honeywell.com

Specifications are subject to change without notice.

For more information

To learn more about HC 900 Process Controller,
visit www.honeywellprocess.com
Or contact your Honeywell Account Manager

Process Solutions

Honeywell
1250 W Sam Houston Pkwy S
Houston, TX 77042

Honeywell Control Systems Ltd
Honeywell House, Skimped Hill Lane
Bracknell, England, RG12 1EB

Shanghai City Centre, 100 Jungi Road
Shanghai, China 20061

www.honeywellprocess.com



51-52-25-110 Rev.15
September 2913

©2013 Honeywell International Inc.