

CALogix

Programming and Installation Manual



CAL Controls

Introduction

Installation

<i>Mechanical Installation</i>	4
a) Base-unit	4
b) Control module	4
c) Mounting	4
d) Removing a module	5
e) Removing the base-unit from DIN-rail	5
f) Cleaning	5
g) Dimensions	6
<i>Electrical Installation</i>	7
a) Output devices	7
b) Supply Voltage	7
c) Wiring a connector	7
d) Replacing modules	7
e) Inductive loads	7
f) EN61010	7
g) EMC guidelines	8
h) Supply and RS485 communications connections	9
i) Input options (module)	9
j) Output options (module)	9
k) Example circuit	10
l) Input sensor selection	10
<i>Configuring CALogix</i>	11
a) CALogix network	11
b) Multiple CALogix network	11
c) CALogix-sw minimum PC requirements	12
d) Installing CALogix-sw	12
e) Running CALogix-sw	12
f) Using CALogix-sw	13
<i>Diagnostics</i>	13
CALogix-sw configuration software	14
<i>Starting CALogix-sw</i>	14
<i>Connecting to a controller</i>	14
<i>CALogix-sw toolbar</i>	14
<i>Base-unit setup</i>	15
<i>Configuring a PID module</i>	16
a) Settings menu	16
b) Viewing Parameter settings	16
c) Changing a setting value	16
d) Initial settings	16
e) Park Mode	17
f) Setpoint adjustment	17
g) Autotune	17
h) Proportional cycle time	17
i) Second and third setpoints	18
j) Heat-Cool	18
k) Recalibration	19
l) Linear inputs	19

m) Error messages	20
n) PID module settings	20
<i>Programmer</i>	25
a) Function overview	25
b) Accessing the programmer interface	25
c) Programmer interface	25
d) Creating a program	25
e) Program segment types	26
f) Program properties	28
g) Reading program data from a controller	28
h) Creating an additional program	29
i) Selecting a program	29
j) Insert segments to a program	29
k) Deleting segments	29
l) Modifying a program	29
m) Running Programs	29
n) Stopping a program	30
<i>Logic I/O module and Logic Programming</i>	31
a) Overview	31
b) Logic I/O module settings	31
c) Accessing logic programming	31
d) The logic toolbar	31
e) Placing a function block on desktop	33
f) Arranging function blocks	33
g) Linking function blocks	33
h) Function blocks - selecting operation	33
– Logic	33
▪ Boolean	33
▪ Timer	34
▪ Counter	34
▪ Comparator	34
– Input	35
– Output	35
▪ Physical Output	35
▪ Changing setpoint	35
▪ Manual power	35
▪ Autotune	36
▪ Event input	36
▪ Program	36
i) Inverting Inputs	36
j) Validating a logic program	37
k) Writing a logic program to a controller	37
l) Running and stopping a logic program	37
m) Trace mode	38

Appendix

<i>Function Block Operation</i>	39
a) Boolean tables	39
b) Timer charts	40
<i>Technical Specification</i>	43
Safety and Warranty Information	44

CALogix Installation Instructions

System Overview

CALogix is a modular multi-loop PID controller with logic function capability. The controller consists of a DIN-rail mount base-unit that incorporates the power supply, RS485 communications ports and slots for up to 4 control modules. The control modules are available as PID or Logic I/O and can be selected then mounted into the base-unit as required for the application. Variations in PID control modules include temperature sensor and linear (0-50mV, 4-20mA, 0-5V & 0-10V) inputs with options for relay, ssd or analog (4-20mA, 0-5V & 0-10V) outputs. Logic I/O modules have user defined 0-5, 0-10, 0-24Vdc inputs with relay or ssd outputs. All wiring connectors to the base unit and control modules are plug-in to reduce installation and maintenance times.

CALogix is configured using the Windows™ based CALogix-sw configuration tool which is provided with each base-unit. PID setup, input & output parameter settings, profile creation and writing logic function block diagrams can all be performed within the software utility. These settings can be read, modified and written to and from the controller and also saved on the PC as a file to be recalled at a later date when required. The program also provides information on current process value, set-points and output status which can be useful when commissioning the system.

Mechanical Installation

The controller is designed as two main components

BASE-UNIT

DIN rail mount device containing main CPU and connections for up to 4 control modules.

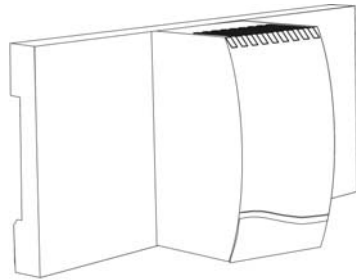

CONTROL MODULE

PID or Logic control modules can be mixed as required for the application and plugged in to base-unit.



1 base-unit and 1-4 control modules must be used for operation of product. A CALogix system can only be configured using CALogix-sw pc-based software.

MOUNTING

To mount a base unit with control modules proceed as follows:

1. Affix 35mm type DIN rail securely to mounting surface, minimum length 140mm. The unit should be mounted vertically as shown.
2. Attach carrier unit to DIN rail ensuring the spring release is at the bottom, facing downward.

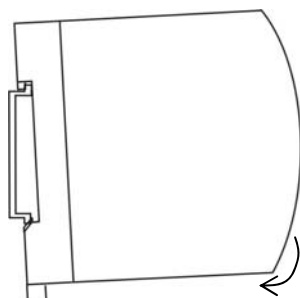

3. Ensuring the input terminals are facing downwards, add the control modules to base unit. Press the top and bottom tabs on the module lightly and ensuring module is kept straight, push to locate in base unit (see diagram below).

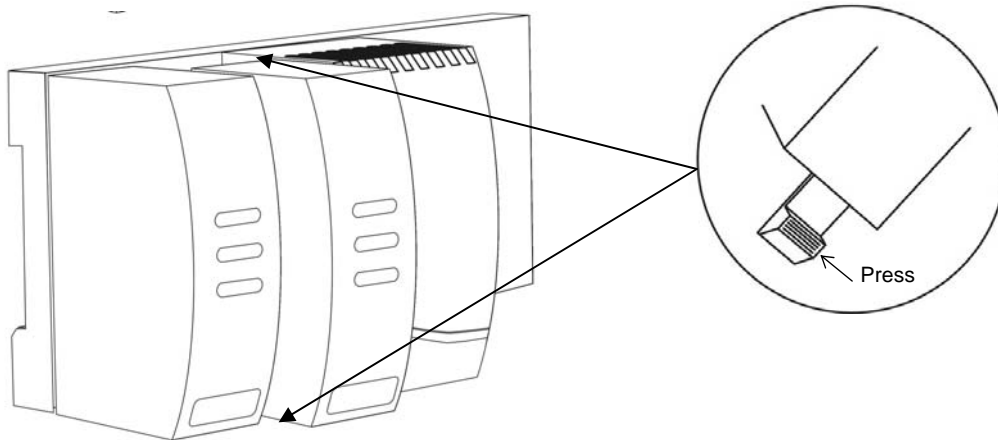

4. Pre-wire connectors and plug into the appropriate modules (we suggest wire markers for identification)

REMOVING A MODULE



1. Isolate supply to CAllogix and all module input and output connectors.
2. Unplug connectors to module requiring removal.
3. Press tabs as shown above to release module.
4. Carefully pull the module away from base-unit ensuring tabs are free to remove.

REMOVING BASE-UNIT FROM DIN-RAIL



1. Isolate supply to CAllogix and all module input and output connectors.
2. Unplug connectors to base-unit and all modules.
3. Insert screwdriver into DIN-rail release block and apply pressure away from the controller, the base-unit can then be removed.

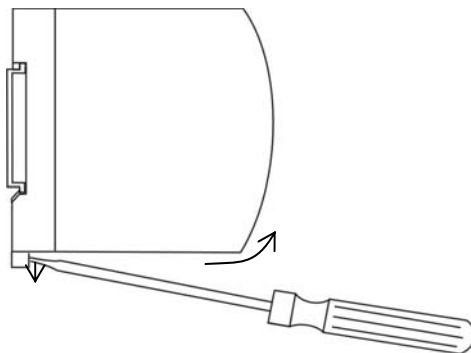

REPLACING A CONTROL MODULE

When replacing a control module follow the instructions above for removing and installing control modules. If a control module is being replaced with another that has the same part number, all parameter settings will be automatically transferred from the base unit to the new module on re-powering the system, no reconfiguration will be required.



If a module is being replaced with a module that has a different part number, ensure that the system is re-wired accordingly and the module settings are modified to reflect the changes made, before running your system. Failure to do so may result in dangerous operation or damage to the system.

If you are replacing logic modules with PID modules, it is important to turn off or delete any associated logic.

CLEANING

Wipe down with damp cloth (water only).

DIMENSIONS

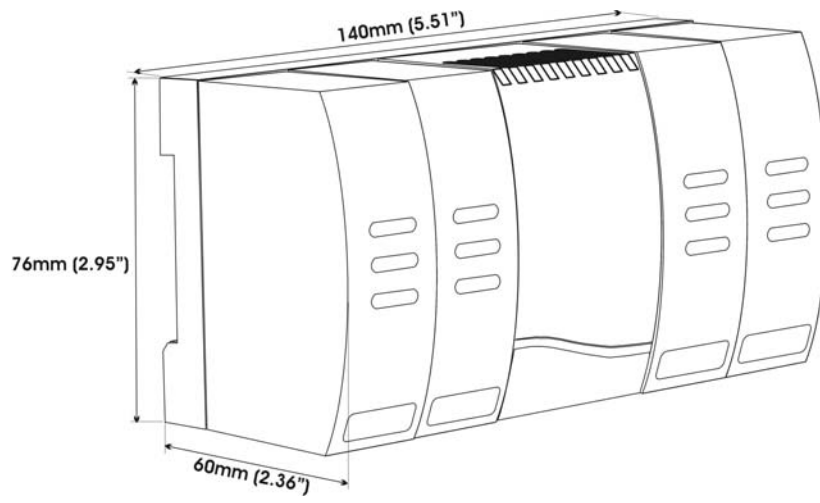

Note Ensure adequate clearance for connectors and wiring

Electrical Installation



The system is designed to be installed in an enclosure which provides adequate protection against electrical shock. The enclosure should also be of a sufficient IP (NEMA) rating for protection against water and dust. CALogix should be mounted in an enclosure with minimum internal dimensions of 160 wide x 125 high x 85 mm deep.

OUTPUT DEVICES

Three types of output are available on an output module: relay, solid state relay drive (ssd) and analog. Output 1 may be any one of the three options, output 2 can be relay or ssd and output 3 is always relay. Any of these outputs can be assigned as SP1, SP2 and SP3 using the CALogix-sw software. Check the model number and output configuration before wiring the instrument and applying power. See section on **output options** for more details.

1. **Solid state relay drive**
12Vdc +10/-15% (nominal), 20mA
To switch remote SSR
2. **Miniature power relay**
2A/250Vac resistive, Form A/SPST contacts
3. **Analog Output (Isolated) - NOT AVAILABLE WITH LOGIC I/O MODULE**
Specify 4-20mA 500Ω max, ±0.1% fs typical
0-5Vdc 10mA (500Ω min). ±0.1% fs typical
0-10Vdc 10mA (1KΩ min). ±0.1% fs typical



SUPPLY VOLTAGE

18-30Vdc, 8 watts ±10% fluctuation permitted

WIRING A CONNECTOR

Prepare the cable carefully, remove between 6 and 8mm insulation and ideally tin or terminate to avoid bridging. Prevent excessive cable strain. Maximum recommended wire size 32/0.2mm 1.0mm² (18 AWG)



REPLACING MODULES

Hot plugging of modules should not be carried out. To change a module always depower the base-unit. Once power is re-applied the carrier will reload the settings for that module and continue with the original module settings. Hotplugging can cause the carrier to fail and is potentially dangerous.

INDUCTIVE LOADS

To prolong relay contact life and suppress interference, it is recommended engineering practice to fit a snubber (0.1μF/100Ω) between relay output terminals.

CAUTION

Snubber leakage current can cause some electro-mechanical devices to be held ON. Check with manufacturers specification.

EN61010 - 1 / UL61010C-1/ CSA22.2 No 1010

Compliance shall not be impaired when fitted to the final installation.
Designed to offer a minimum of basic insulation only.

The body responsible for the installation is to ensure suitable for measurement category II or III

To avoid possible hazards, accessible conductive parts of the installation should be protectively earthed in accordance with EN61010 for Class 1 equipment.

Output wiring should be within a protectively earthed cabinet.

*Sensor sheaths should be bonded to protective earth or not be accessible

Live parts should not be accessible without the use of a tool.

EMC GUIDELINES

We make a number of general recommendations that can reduce the possibility of EMC problems.

- 1) It is important to suppress CALogix relay contacts, this will reduce switching interference and also prolongs life of the contacts.

RC Networks fitted across the relay contacts are recommended for resistive and larger inductive loads, values such as $0.1\mu\text{F}$ capacitor in series with a 100Ω resistor.

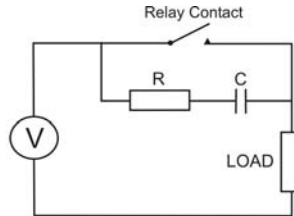

For small inductive loads, a suitable rated VDR is recommended.

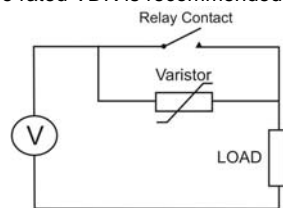

For small inductive dc loads, relays etc, a suitably rated diode fitted in parallel with the load is recommended.

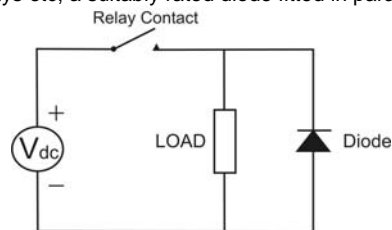

- 2) CALogix should be mounted into a metal cabinet which is properly earthed, good all round metal shielding is important.
- 3) It should be borne in mind that the wiring of the installation can significantly reduce the efficiency of the instrumentation immunity. This is due to the ease with which high frequency RF can enter via unprotected incoming and outgoing cables.

Earthed thermocouples or sensors with screened cable, should be earthed at the cabinet entry point.

Any long cables entering the control cabinet should be protected at the point where they enter the cabinet, large diameter ferrite sleeves are an economical and effective method of reducing high frequency RF, looping the cables through ferrite sleeves a number of times will improve the efficiency of the filtering.

Alternatively for mains cables, the fitting of a suitable mains filter can provide good results.

Data or communications cables should be screened. If using Belden 8132 connect drain wire to PIN 5 of a shielded RJ45 connector.

Ideally data and sensor cables should be routed separately from power cables and away from inverters or other high power/frequency devices.

SUPPLY AND RS485 COMMUNICATIONS CONNECTIONS (BASE-UNIT)

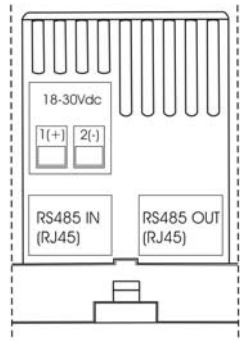

INPUT OPTIONS (MODULE)

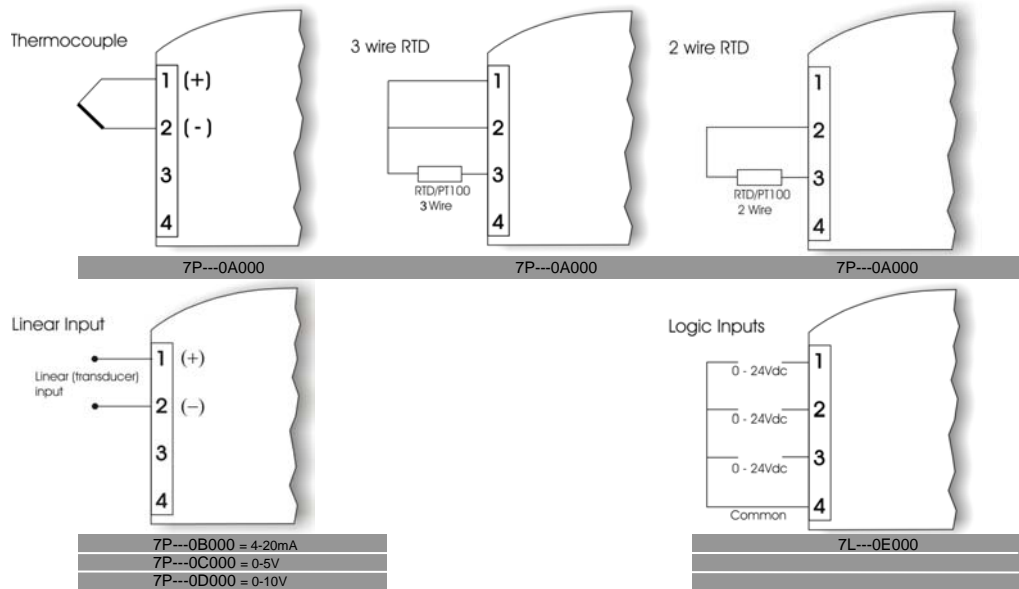

OUTPUT OPTIONS (MODULE)

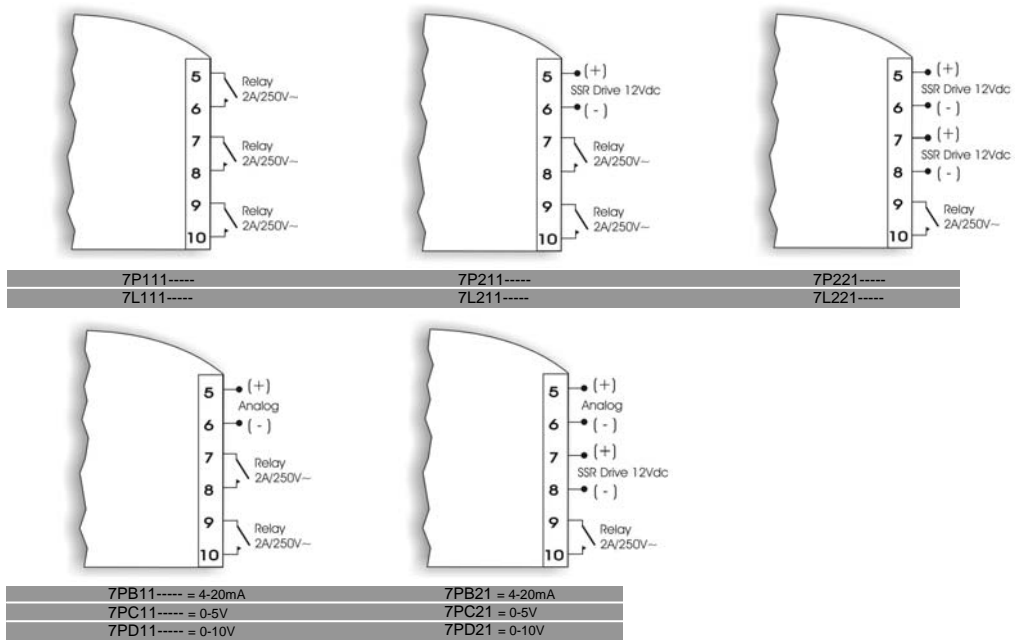

EXAMPLE CIRCUIT

The circuit below shows an example application which includes a base-unit that has one PID module and one logic module fitted.

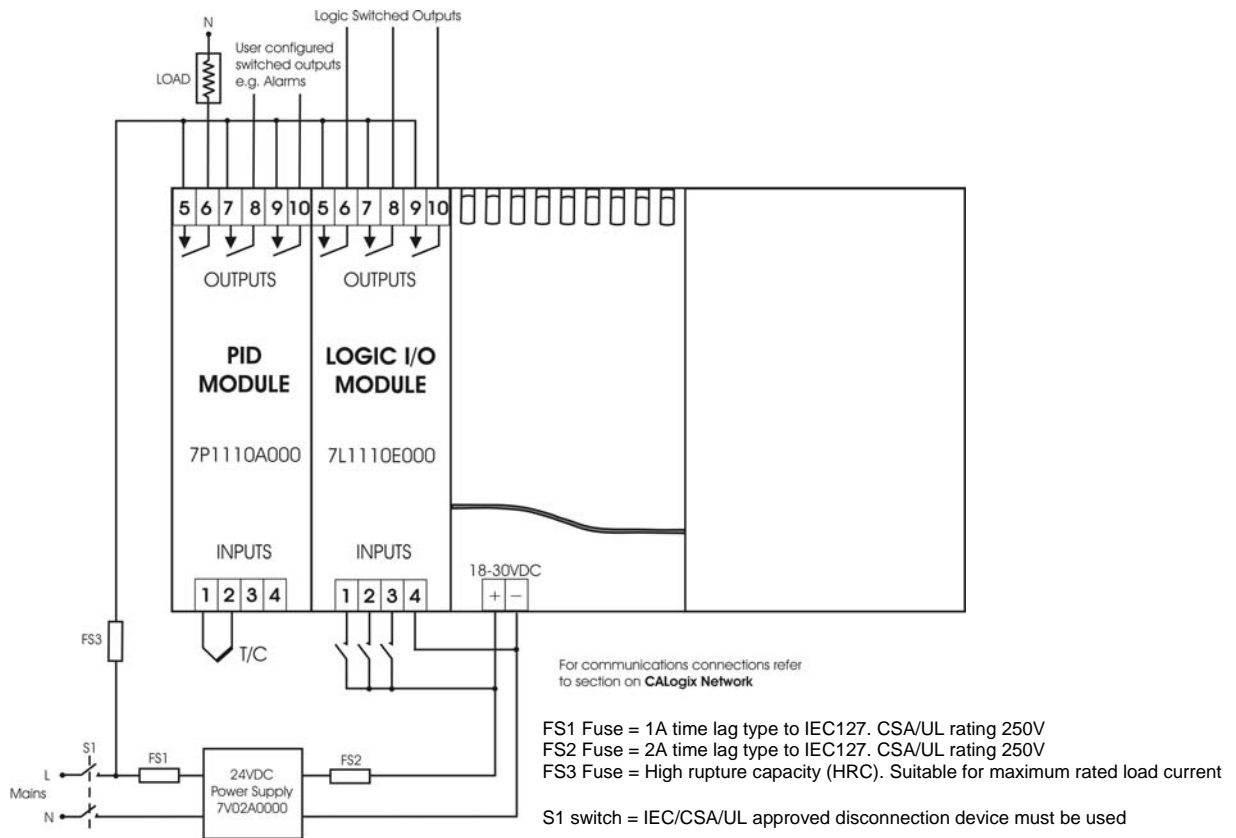

It is strongly recommended that the power supply zero volts and all logic module zero volts are common to prevent ground loops.

INPUT SENSOR SELECTION

Thermocouple type	Description	Sensor Range (°C)	Sensor Range (°F)
B	Pt-30% Rh/Pt-6%Rh	0 to 1800°C*	32 to 3272°F*
E	Chromel/Con	0 to 600°C	32 to 1112°F
J	Iron/Constantan	0 to 800°C	32 to 1472°F
K	Chromel/Alumel	-50 to 1200°C	-58 to 2192°F
L	Fe/Konst	0 to 800°C	32 to 1472°F
N	Nicrosil/NiSil	-50 to 1200°C	-58 to 2192°F
R	Pt-13%Rh/Pt	0 to 1600°C	32 to 2192°F
S	Pt10%Rh/Pt	0 to 1600°C	32 to 2192°F
T	Copper/Con	-200 to 250°C	-273 to 482°F
Resistance Thermometer rtd 2/3 wire	Pt100/RTD-2/3	-200 to 800°C	-273 to 1472°F

* Note : Type-B accuracy not specified below 100°C/212°F

Configuring CALogix

CALogix is configured using Windows-based CALogix-sw software. Before using CALogix-sw, connect CALogix to a PC as shown below:

CALOGIX NETWORK

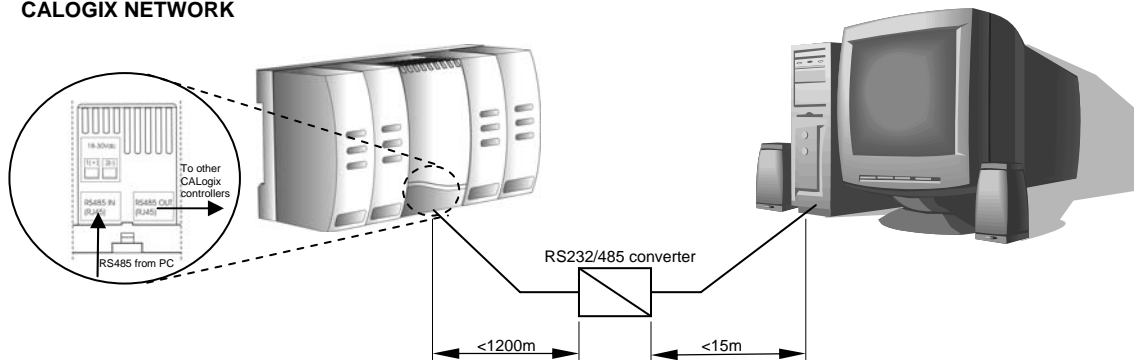

CALogix uses RS485 full duplex serial communications link which is the standard most commonly used for industrial applications due to high noise immunity and multi-drop capability. It enables a PC to communicate with up to 31 CALogix base-units over distances up to 1200 metres, and requires the addition of an RS485 interface card, or a separate RS232 / 485 converter connected to the RS232 port of the PC. RS485 converters that derive power from the RS232 port must have all 9 pins (RS232) connected for full operation of the converter.

RS485 cards and converters can differ greatly in their requirements and therefore the installation instructions supplied with the interface should be read carefully.

2m CALogix-PC cable (part number - CAB RJ45 2M 01) and a RS232/485 converter (part number 3C 25 000 K 3X) that fits directly on to the RS232 serial port on a PC are available from your nearest CAL Controls distributor.

If wiring your own cable the RS485 connections are as follows.

RJ45 PIN

2	→	RX+
3	→	RX-
4 / 5	→	GND
6	→	TX-
7	→	TX+

As CALogix is designed for an industrial environment, CAL recommends using a 4 wire shielded RS485 cable such as Belden 8132. Ensure that connectors are suitable for use with shielded cable and are correctly bonded.

Auto-baud rate function. On power up CALogix detects the network speed and automatically adjusts its baud rate accordingly. If the network baud rate is later modified, remove the power and reapply so that CALogix can resynchronise to the new baud rate.

MULTIPLE CALOGIX NETWORKS

Each CALogix unit has an RS485-in and RS485-out RJ45 socket. To connect a number of CALogix units on a network, wire as shown below. The cables should be wired so that the corresponding pins of RS485-out are connected to the same pin number on RS485-in of the next controller i.e. Pin 2 (out) to Pin 2 (in), Pin 3 (out) to Pin 3(in), Pin 5(out) to Pin 5(in), Pin 6(out) to Pin 6(in) and Pin 7(out) to Pin 7(in).

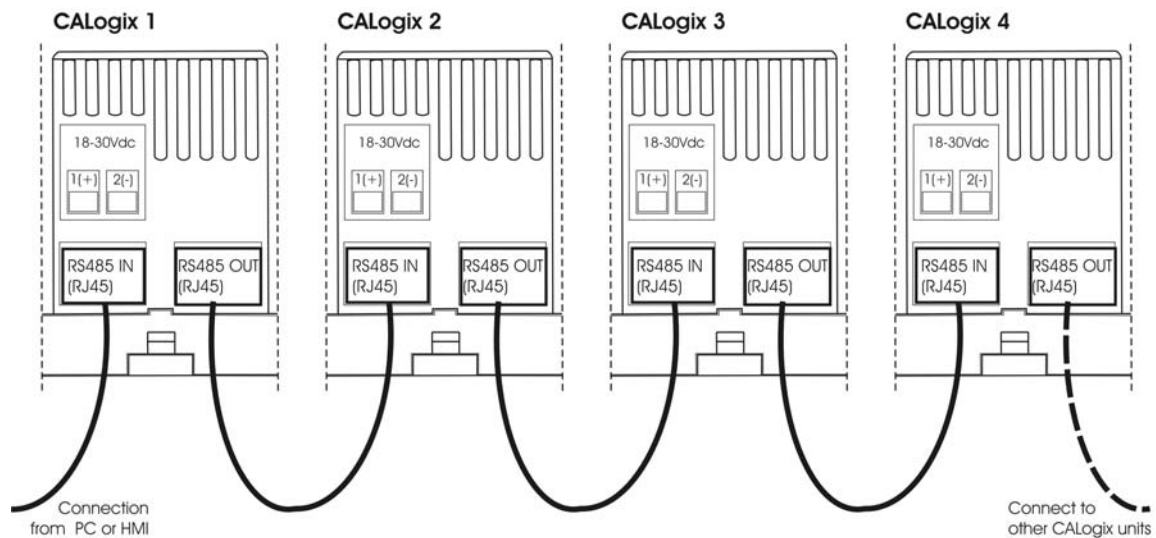

For multiple instrument networks each transmission line must be properly terminated to prevent reflections. 120Ω termination resistors should be fitted between TX+ & TX- and RX+ & RX- at the connection to the PC in addition to the last instrument in the chain. See example below.

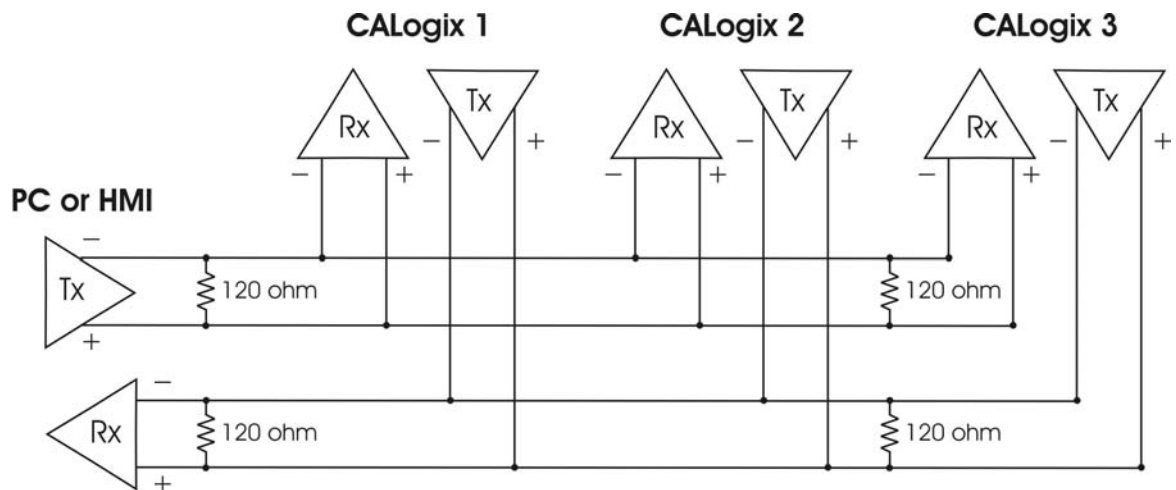

When transmission lines are not transmitting, they remain in an intermediate state which can allow receivers to receive invalid data bits due to electrical noise on the cable. To prevent this bias resistors may be required to force the lines into a known state. Some RS485 interface cards and converters may have bias resistors fitted please check manufacturer's specification and recommendations for use of bias resistors.

Note: The default Modbus address for each base-unit is 1, for a network with a number of CALogix units, power-up each unit individually and configure them with a unique Modbus address using CALogix-sw configuration tool. (See section on base-unit set-up in manual)

CALOGIX-SW MINIMUM PC SYSTEM REQUIREMENTS

As a general requirement, we would recommend a minimum of Pentium 450MHz with 256MB RAM, Windows™ 2000/XP and screen resolution, 1024 x 768.

INSTALLING CALOGIX-SW

1. Insert CALogix-sw disk into CD-drive.
2. CALogix-sw install program should auto-run. If this does not happen, manually run 'setup.exe' on CALogix-sw cd.
3. Follow on screen instructions to complete installation.

RUNNING CALOGIX-SW

1. Click 'start' on Windows toolbar.
2. Mouse-over 'all programs'.
3. Mouse-over 'CALogix folder' in menu.

4. Click on 'CALogix' icon.
5. CALogix program should now run.

USING CALOGIX-SW

1. Refer to on-screen help or CALogix programming manual contained on CALogix-sw CD.

Diagnostics

Each control module has LEDs to indicate when each of the outputs are on (or relay closed). If an analogue output option is fitted the LED dims proportionately with the output level, e.g. a PID module with a 4-20mA output, the LED will be dim at 4mA and bright at 20mA.

Note: The output and the LED indicator are physically linked and always represent the true state of the output.

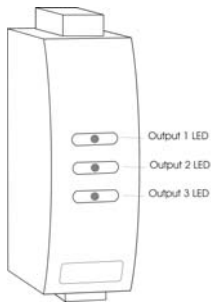

CALogix base-unit has three status LED's to assist with diagnosing problems

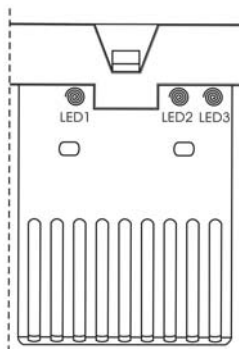

LED 1 – Communications

Off	No communications
On/Pulsing	Communications active

LED 2 – CALogix healthy (Heartbeat)

Slow pulse	Unit operating correctly
Fast Pulse	Base-unit emergency (comms still running)
On	Base-unit lock-up

When base-unit emergency/lock-up conditions exist recycle power to clear. If the problem does not clear on power recycle contact CAL controls for technical support.

LED 3 – Logic

Off	Logic not active
On	Logic active

To start logic program running refer to section on **running logic programs**

CALogix-sw Configuration Software

STARTING CALOGIX-SW

1. Click 'start' on Windows toolbar
2. Mouse-over 'all programs'
3. Mouse-over 'CALogix folder' in menu
4. Click on 'CALogix' icon
5. CALogix program should now run

CONNECTING TO A CONTROLLER

1. Click on  to add a new instrument
2. Click on browse



3. Select communications port, baud rate and Modbus address (default 1). Once settings are entered click on browse.



4. CALogix unit is then shown in device list when detected. Click on OK.

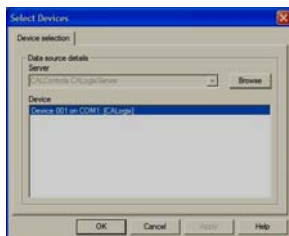

5. Window now opens showing CALogix unit with data on installed modules



THE CALOGIX-SW TOOLBAR



New meter (visible when no controller open)
Search for a CALogix system on a network.



New device (visible when controller open)
Access a different CALogix base-unit.

**Open File**

Open controller application settings or logic program file.

Note : when a saved application or logic file is loaded to a CAlLogix unit, the logic program will not be running.

**Save**

Save controller application settings or logic programs.

**Export Application**

Creates rich text file (.rtf) with application settings data

**Export device**

Creates rich text file (.rtf) with current device settings data

**Export program** (only available when programmer interface is open)

Creates rich text file (.rtf) with device program data

**Export logic** (only available when logic desktop is open)

Creates rich text file (.rtf) with logic program data

**Properties**

Select security settings, see section on **security settings**

**Edit programs**

Open programmer interface for profile creation, see section on **programmer**

**Edit logic**

Open logic desktop, see section on **logic programming**

**About****BASE UNIT SETUP**

To access settings for a base unit

1. Right-click on controller image.

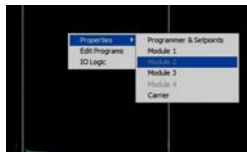

2. Mouse over properties, then left-click on **base-unit**, see diagram above.
3. Double-click on **(+)** to expand menus.



4. Base-unit settings are shown as below.

Base-unit Configuration	Default	Options
Baud rate The network baud rate can be read. CAlLogix baud rate is automatically set on power-up to match the baud rate used by the Modbus master.	9600	2400, 4800, 9600, 19200, 38400, 57600, 115200. (<i>read only</i>)
Modbus address The base-unit Modbus address can be set to a value of 1 to 255. A maximum of 31 base-units can be connected in a network.	1	1 to 255, step 1
Base-unit diagnostics	Default	
Serial number The CAlLogix serial number is factory set before shipment	Preset (<i>read only</i>)	
Firmware version	Preset (<i>read only</i>)	

Note : If the Modbus address is changed CAlLogix-sw will loose communications with the base-unit as it is still communicating using the original address. If the address is changed, exit CAlLogix-sw and browse for the controller using the new address.

CONFIGURING A PID MODULE

SETTINGS MENU

To access settings for a PID module

5. Right-click on controller image.

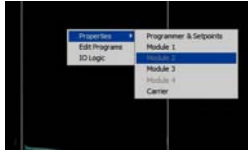

6. Mouse over properties, then left-click on the required PID module number, see diagram above.
7. The settings menu will now open

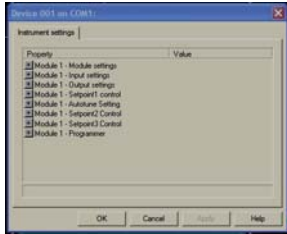

VIEWING PARAMETER SETTINGS

1. CALogix PID module settings are split into various sub-menus to simplify finding the correct parameter. These are
 - Module settings
 - Input settings
 - Output settings
 - Setpoint1 control
 - Autotune setting
 - Setpoint2 control
 - Setpoint3 control
 - Programmer
2. For details of parameters in each of the sub-menus see section on 'PID Module settings'.
3. To expand a sub-menu double-click on '+' next to the menu title.
4. Scroll to find required parameter.
5. To close sub-menu click on '-'.

CHANGING A SETTING VALUE

1. Double-click on value box of parameter.
2. Enter value for parameter. Some parameters will have a drop down list, select required option from list in these cases.
3. Click on parameter name to accept setting.
4. Repeat for all other required setting changes
5. Once complete click on 'apply'.
6. The setting changes will now be written to controller.

INITIAL SETTINGS

There are a number of key settings required before initial operation of a CALogix PID module.

1. **Input sensor type** (Input settings menu)
Select input sensor type from drop down list (Default J)
When changing the sensor type ensure that the **setpoint 1 upper and lower limits** are set to values that will allow the setpoints you wish to enter
If selecting linear refer to section on **linear inputs**
2. **Select operating unit** (Module settings)
Select process units from drop down list.
3. **Allocate outputs 1,2 & 3** (Output settings)
Allocate physical outputs 1, 2 and 3 to SP1, SP2, SP3. Any physical output can be assigned as any setpoint, but each output can only be assigned once.



Note: If the outputs have been previously allocated to a set-point and you wish to change assignment, then the outputs need to be set to none and this setting applied before you can re-allocate a new output to a setpoint. Please consider any wiring changes that may be required.

- Once these settings have been made click on apply to write to the controller.

PARK MODE

Once initial settings are written to the controller it will still be in **park mode** i.e outputs to the controller are disabled. To take the controller out of park, change mode (setpoint 1 settings) to control type required i.e P (proportional), PI (proportional integral), PID (proportional integral derivative), PD (proportional derivative) or ON/OFF control.

SETPOINT ADJUSTMENT

Before carrying out an autotune or run with the default settings ensure the system is safe to operate at the setpoint value.

To enter or adjust a setpoint 1:

- Right click on controller image.



- Mouse-over properties and select **programmer and set-points**.
- Expand **(+) setpoints menu**.

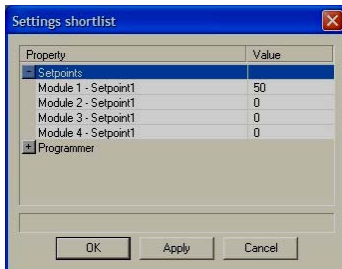

- Enter **Setpoint 1** value for the required module (click out of value box once setting entered to ensure value is accepted)
- Apply** setting and click **OK**
- New setpoint is now written to the controller and should be visible on controller image.

Changes in setpoint 2 and 3 are made in the settings menu see **PID module settings**

AUTOTUNE

This is a single shot procedure to match the PID module to the process. Select either **tune** or **tune-at-setpoint** in the **mode** parameter of **autotune settings** for a specified module. The criteria for choosing the best autotune mode for an application is given below.

The **tune-at-setpoint** program is recommended when:

- The process is already at setpoint and control is poor.
- The setpoint is less than 100°C in a temperature application
- Re-tuning after a large setpoint change.
- Tuning multi-zone and/or heat-cool applications.

Notes: DAC is not re-adjusted by **tune-at-setpoint**.

Before running autotune select whether autotune calculated **proportional cycle time** is to be used see below.

The **tune** program should be used for applications other than those listed for **tune-at-setpoint** shown above.

As autotune is running, **tune** or **atsp** is displayed on the CALogix module image within CALogix-sw. Once tuning is complete, the message will no longer be visible.

PROPORTIONAL CYCLE-TIME

The choice of cycle-time is influenced by the external switching device or load. eg. contactor, SSR, valve. A setting that is too long for the process will cause oscillation and a setting that is too short will cause unnecessary wear to an electro-mechanical switching device.

To select AUTOTUNE calculated CYCLE-TIME

- In 'autotune settings' menu for chosen module, change **autotune cycle-time** parameter to **yes**.

If the **autotune cycle-time** is not required, set parameter as **no** and **cycle time** parameter value in **setpoint settings** will be used. (default value 10S)

Cycle time recommendations

- It is recommended that relay outputs should not have a cycle time of less than 10S. If a cycle time of less than 10s is required, solid state drive outputs are advised.

SECOND AND THIRD SETPOINTS (SP2 and SP3)

Primary Alarm Modes

- Configure SP2 and SP3 outputs to operate as an alarm from **setpoint 2 and 3 control sections** in the '**module settings menu**'

The alarms will be individually triggered when the process value changes according to the options listed below.

DVHI	Rises above the main setpoint by the value inserted at setpoint 2 or 3
DVLO	Falls below the main setpoint by the value inserted at setpoint 2 or 3
Band	Rises above or falls below the main setpoint by the value inserted at setpoint 2 or 3
FSHI	Rises above the full scale setting of setpoint 2 or 3
FSLO	Falls below the full scale setting of setpoint 2 or 3
COOL	Heat-cool operation, see section on heat-cool
EOP	Event Output (See Programmer section)

Subsidiary SP2 / SP3 modes

- The following additional subsidiary alarm functions can be added to any primary alarm configurations.

Latch	Once activated, the alarms will latch and can be manually reset via CALogix-sw or an operator panel when the alarm condition has been removed.
Hold	This feature inhibits alarm operations on power-up and is automatically disabled once the process reaches the alarm setting.
Lt.ho	Combines the effects of both Latch and Hold and can be applied to any primary alarm configuration

If you configure SP2 or SP3 as an alarm in on.off mode please be aware the output and LED indicator to the alarm will be energised when the alarm is not active and de-energised when alarm is active. By setting **display alarm** (setpoint 2 and 3 settings) to **on** the alarm display indicator (bell) will replace the output LED in CALogix-sw when an alarm condition exists.

Note : Changing SP2 or 3 operating mode will default the setpoint back to zero when applied to the base-unit, this will not be updated in the property sheet until closed and read back.

HEAT-COOL

Heat-cool strategy is a feature that improves control of processes that need heating and cooling, for example:

- Environmental test chambers used in rooms where ambient temperature can vary above and below test temperature.
- Plastics extruders where the material initially needs heating, then cooling, when it begins to heat itself exothermically due to pressure and friction applied by the process.

The purpose of cool strategy is to maintain accurate control of the process with a smooth transition between heating to cooling. This is achieved by using PID control for both heating and cooling with the proportioning bands linked by an adjustable deadband.

Tuning CALogix for heat-cool

Enter a setpoint then allow the process to reach the setpoint using factory settings for heating only. Ensure that procedure for **initial settings** has been carried out before heating the application.

When application process value has stabilised at setpoint change the following parameters

<u>Parameter</u>	<u>Menu</u>	<u>Value</u>
DAC	Setpoint 1 control	1
Cycle time	Setpoint 1 control	10
Operating mode	Setpoint 2 control	COOL
Cycle time	Setpoint 2 control	10
Use cycle time	Autotune settings	No

Apply these settings then set

Mode	Autotune settings	ATSP
-------------	-------------------	-------------

When the setting is applied there will be a temporary disturbance in temperature as autotune is running. 'ATSP' is displayed on the module within CALogix-sw controller image. Once 'ATSP' is no longer displayed the controller is tuned.

Further settings

If regular oscillations occur change **Use cycle time** to **Yes**. See section on **proportional cycle time**.

Note : minimum recommended cycle time using relay outputs is 10s.

Autotune sets PID terms for Heat and Cool with the same setting values. **Band, integral time, derivative time, DAC and derivative sensitivity** settings can all be modified independently for both heat (setpoint 1 settings) and cool (setpoint 2 settings).

In some processes oscillations occur during cooling. If this occurs double the value of **band** (setpoint 2 settings). If no improvement return **band** (SP2) to its original value and half the **cycle time** (setpoint 2 settings)

If the process hunts between heating and cooling a deadband setting may be needed. Enter a small value e.g.1 for **Setpoint 2** (setpoint 2 settings)

Water cooled applications

Water cooled applications at temperatures greater than 100°C may suffer from the non linear effect caused by water turning to steam. This can be countered by setting **subsidiary mode** (setpoint 2 settings) to **NLIN**.

Multi zone applications

When tuning multi zone applications like extruders, distortions due to thermal interaction between adjacent zones can be minimised by running autotune on all controllers at the same time.

RECALIBRATION

If the controller and instrument readings are different, the **zero** and **span** (input settings) will require adjustment.

Adjust **zero** to make an equal adjustment across the full scale of the controller and/or **span** to make a correction where the error increases or decreases across the scale.

1. To adjust the **zero** function substitute the measured values in the expression

Instrument reading – controller reading = **zero**

Example: Instrument reading = 245
Controller reading = 250

$$245 - 250 = -5$$

Adjust **zero** to -5 to correct the error.

2. Adjusting the **span** function i.e. to make a correction when errors are different across the scale.
 - a) Choose a temperature near the bottom and another near the top of the scale
 - b) Run the process at the lower temperature (**T1**). Note the error (**E1**) between the controller and the instrument readings.
 - c) Check value of **setpoint 1 upper limit (SP1UL)** in input settings menu.
 - d) Repeat at the upper temperature (**T2**) and note error (**E2**)
 - e) Substitute the values for **T1, T2, E1, E2** in the expression below;

$$\frac{E2 - E1}{T2 - T1} \times SP1UL = \text{span}$$

Example	T1	T2
Instrument reading	58	385
Controller reading	60	400
Error	E1 = -2	E2 = -15

Substituting values in the formula

$$\frac{(-15) - (-2)}{385 - 58} \times 450 = \frac{(-13) \times 450}{327} = -17.9$$

Therefore adjust **span** to **-18** to correct error.

Notes:

1. After making the adjustment the reading will immediately change. Allow time for the temperature to stabilise at **T2** before making any further adjustment. At this point **zero** adjustment may be needed, refer to step 1 above.
2. Check that the temperature correctly stabilises at **T2** and then adjust setpoints to **T1**. If an error is present at **T1** repeat from step 2.

LINEAR INPUT

Modules can be ordered with analog inputs for use with other field devices and instruments. Check the specification of the device providing the input to ensure it is compatible.

Set-up Procedure

- **4-20mA**

The **4–20mA** input model converts current into voltage using an internal resistor which spreads the signal across the input range **10 to 50 mV** using a multiplier of 2.5. When using a transducer with an output less than 4–20mA, the **input maximum and minimum mV** values can be calculated using the same multiplication factor.

- **0-5V**
Models with **0** to **5V** input use an internal resistor to spread the signal across the input range **0** to **50 mV** using a divider of 100. Where a transducer provides a smaller output, the **input maximum and minimum** values can be similarly calculated.
- **0-10V**
Models with **0** to **10V** input use an internal resistor to spread the signal across the input range **0** to **50 mV** using a divider of 200. Where a transducer provides a smaller output, the **input maximum and minimum** values can be similarly calculated.

Decide what scale **minimum** and **maximum** will be required, and whether the scale needs **inverting**.

Example

The example below gives an example of how a 4–20mA input could be configured for an application.

The input to the controller is linear where 4mA = 80 units and 20mA = 300 units.

Action	Parameter Menu	Parameter Value
Select input sensor type	Input settings	linear
Select unit	Module settings	select from list, if unit not available select Set
Allocate SP1 output	Output settings	Select output 1, 2 or 3
Enter Linear high	Input settings	Enter 50 (represents 20mA i.e. multiplier 2.5)
Enter Linear low	Input settings	Enter 10 (represents 4mA i.e multiplier 2.5)
Enter Linear low scale	Input settings	Enter 80 (i.e. units at 4mA)
Enter Linear high scale	Input settings	Enter 300 (i.e. units at 20mA)
Enter display resolution	Input settings	Set as 0.01, 0.1, 1

Note: changing the display resolution will affect set-point value and other operating parameters. Ensure that display resolution settings are selected before adjusting set-point and tuning the controller to the application.

ERROR MESSAGES

CALogix-sw error messages are shown below

Tune Fail - Will be displayed if an autotune cycle fails

1. Check setpoint is not set at 0
2. The characteristics of the load exceed the algorithm limits
 - i. Change conditions e.g. raise setpoint
 - ii. Try tune at setpoint, **atsp**
 - iii. If error persists call local CAL representative.

Input Fail – Sensor is open/short circuit or linear input is over range. Check sensor/wiring/connections.

Error On/Off – **Error On/Off** will be displayed if autotune when in **On/Off** control.

PID MODULE SETTINGS

(* = module position number)

Module * - settings	Default	Options
Module name A user defined label (name) up to 10 characters can be set for each module.	Module *	User defined
Operating units Process-value operating units can be defined as °C, °F, Bar, PSI, Ph, RH or Set.	None	°C, °F, Bar, PSI, PH, RH, Set, None
 Important note: If switching from °C to °F or vice versa, ensure that set-point and other temperature-value based parameter settings are adjusted accordingly to reflect the change made. Failure do so may result in dangerous operation or damage to the system.		
Module * – input settings	Default	Options
Sensor Type	J	B, E, J, K, L, N, R, S, T, RTD 2-wire, RTD 3-wire, linear, custom sensor**, custom sensor with cjc**.
Display Resolution	1	0.01, 0.1, 1

**consult factory

Resolution of PV and Setpoint on CALogix-sw can be set as 0.01, 0.1 or 1. This resolution is also the format used for the corresponding data register with CALogix unit to be read by an operator panel or for data acquisition. It is recommended that display setting of 0.01 is NOT used when a thermocouple or PT100 sensor is used as the displayed value will fluctuate.

Setpoint 1 upper limit Sets a maximum permissible value for Setpoint 1	Sensor Max	-9999 to 9999 step 0.01
Setpoint 1 Lower limit Sets a minimum permissible value for Setpoint 1	Sensor Min	-9999 to 9999 step 0.01
Span Offset Realigns readings to match another instrument e.g. calibration source or meter see note on recalibration.	0.0	-9999 to 9999 step 0.01
Zero offset Zero sensor error. +ve zero offset increases measured PV, -ve zero offset reduces measured PV, see note on recalibration.	0.0	-9999 to 9999 step 0.01
Linear High Configures maximum linear input see Linear inputs	50.0	0.0 to 50.0 step 0.1
Linear Low Configures minimum linear input, see Linear inputs	10.0	0.0 to 50.0 step 0.1
Linear high scale Scale controller to display value at Linear high value	1000	-9999 to 9999 step 0.01
Linear low scale Scale controller to display value at Linear low value	0	-9999 to 9999 step 0.01

Module * - Output settings	Default	Options
Setpoint 1 output Select physical output to be assigned as Setpoint 1.	None	Output 1, Output 2, Output 3
Setpoint 2 output Select physical output to be assigned as Setpoint 2	None	Output 1, Output 2, Output 3
Setpoint 3 output Select physical output to be assigned as Setpoint 3	None	Output 1, Output 2, Output 3
Output 1, 2 & 3 burnout state Configure state of outputs on sensor burnout / break	De-energised	De-energised, Energised
Output 1, 2 & 3 inversion Reverse operation of outputs	False	False, True
Output 1 inhibit Prevents other outputs energising at the same time as Output1	None	None, Output 2, Output 3
Output 1,2 & 3 cycle count Each module internally stores a read-only value of the number of cycles for each output, this can be used to check the estimated remaining life of a mechanical relay, if fitted.	-	Count value (Read only)

Module * – Setpoint 1 control	Default	Options
Setpoint 1 Change setpoint 1 value	0	-9999 to 9999, step 0.01
Mode Primary control type for setpoint 1	Park	P, PI, PID, PD, Park, On/Off
	P	Proportional
	PI	Proportional Integral
	PID	Proportional Integral Derivative
	PD	Proportional Derivative
	Park	Holds controller operation – disables output
	On/Off	On/Off Control
Band SP1 proportional band or Hysteresis -* 100% sensor maximum, proportional control eliminates the cycling of on-off control. Output power is varied, by proportioning action, across the proportional band	10	0 to 9999, step 0.01
Integral Time SP1 integral time/reset - Auto-corrects proportional control offset error	5 mins	0 to 9999, step 0.1
Derivative time SP1 derivative time/rate - Suppresses overshoot and speeds response to disturbances	25 secs	0 to 200, step 1
DAC SP1 derivative approach control dAC - Tunes warm-up characteristics, independent of normal operating conditions, by adjusting when derivative action starts during start-up (smaller dAC value = nearer setpoint).	2	0.5 to 8, step 0.5

Change setpoint 2 value

Band **2** -9999 to 9999 step 0.01
SP2 proportional band or Hysteresis -* 100% sensor maximum, proportional control eliminates the cycling of on-off control. Output power is varied, by proportioning action, across the proportional band

Integral time **5 mins** 0 to 1000, step 0.1
SP2 integral time/reset - Auto-corrects proportional control offset error

Derivative time **25 secs** 0 to 200, step 1
SP2 derivative time/rate - Suppresses overshoot and speeds response to disturbances

DAC **2** 0 to 5 step 0.5
SP2 derivative approach control dAC - Tunes warm-up characteristics, independent of normal operating conditions, by adjusting when derivative action starts during start-up (smaller dAC value = nearer setpoint).

Derivative sensitivity **0.5** 0.1 to 1, step 0.1

Cycle time **10 secs** 0.1 to 9.9, step 0.1
 10 to 81, step 1

SP2 proportional cycle-time - Determines the cycle rate of the output device for proportional control. The choice of cycle-time is influenced by the external switching device or load. eg. contactor, SSR, valve. A setting that is too long for the process will cause oscillation and a setting that is too short will cause unnecessary wear to an electro-mechanical switching device.

Maximum power **100** 0 to 100, step 1
 Maximum % proportional output of SP2. When using proportional control the output of SP3 will not exceed maximum power setting.

Minimum Power **0** 0 to 100, step 1
 Minimum proportional output of SP2. When proportional control is used the output of SP3 will not reduce below the minimum power setting.

Output power **Read Only** 0 to 100, step 1
 The current proportional output of SP2 shown as %.

Manual power **Off** Off, 0 to 100, step 1
 Manual power overrides PID calculated power output. The proportional output for SP1 will remain constant at the entered value. To return to PID control set manual power to 0.

Display alarm **No** No, Yes
 When set to yes, alarm symbol is shown on controller image within CALogix-sw when an alarm output is switched.

Reset latched alarm **No** No, Yes
 Used to clear a latched alarm output on SP2, once the alarm condition has cleared. Set value to **yes** to clear.

Module * - Setpoint 3 control	Default	Options
Operating mode	None	DVHI, DVLO, BAND, FSHI, FSLO, EOP, None
Mode	PARK	P, PARK, On/Off
Primary control type for setpoint 3		
P	Proportional	
Park	Holds controller operation	
On/Off	On/Off Control	
Subsidiary mode	None	LTCH, HOLD, LTHO
Setpoint 3 Change setpoint 3 value	0	-9999 to 9999, step 0.01
Band	2	-9999 to 9999, step 0.01
SP3 proportional band or Hysteresis -* 100% sensor maximum, proportional control eliminates the cycling of on-off control. Output power is varied, by proportioning action, across the proportional band		
Cycle time	10	0.1 to 9.9, step 0.1 10 to 81, step 1
SP3 proportional cycle-time - Determines the cycle rate of the output device for proportional control. The choice of cycle-time is influenced by the external switching device or load. eg. contactor, SSR, valve. A setting that is too long for the process will cause oscillation and a setting that is too short will cause unnecessary wear to an electro-mechanical switching device.		
Maximum power	100	0 to 100, step 1
Maximum % proportional output of SP3. When using proportional control the output of SP3 will not exceed maximum power setting.		
Minimum Power	0	0 to 100, step 1
Minimum proportional output of SP3. When proportional control is used the output of SP3 will not reduce below the minimum power setting.		
Output Power	Read Only	0 to 100, step 1

PROGRAMMER

FUNCTION OVERVIEW

The Programmer function enables CALogix to control applications that require **setpoint** changes over time. Examples of this are **ramp** changes where setpoint is gradually increased at a specified rate until a target level is reached or **step** changes which are instantaneous. These can be separated by **soak** periods during which the process is held at a constant value. Each individual time interval of the program or **segment**, together with its associated moving setpoint value can be stored as a unique **program**. An example is shown below.

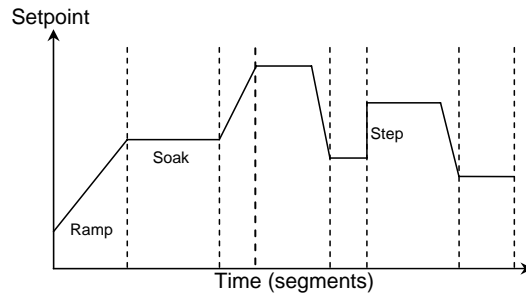

In addition to those settings that determine the segment profile, it is also necessary to set **program start** values, together with the preferred **ramp rate time units** for each individual program. At the end of a sequence, a program can be arranged to repeat (**loop**), either a specified number of **cycles**, or continuously. Only one **loop** can be included in a **program**. When the program is running, CALogix-sw indicates progress through the sequence of segments and can additionally be interrogated for further segment information. It is also possible to **Call** an already existing program as a sub program that can be inserted as a segment of another program.

The programmer functions can be fully configured using the programmer interface in CALogix-sw.

ACCESSING THE PROGRAMMER INTERFACE

1. Click on the  icon in the main toolbar.
2. **Programmer interface** should now be open .

THE PROGRAMMER INTERFACE

The programmer interface is shown below.

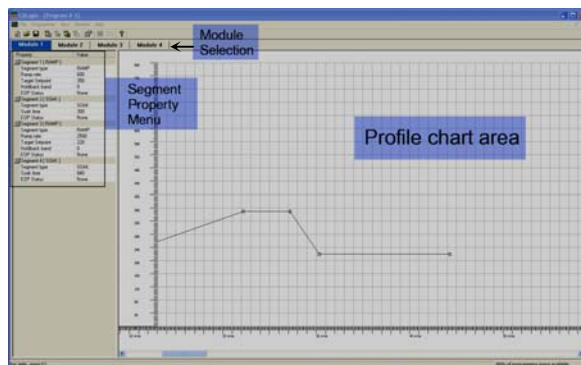

CREATING A PROGRAM.

Note : If a program is running in any module on the carrier the programmer interface will only be available in **view mode** only. All programs have to be in an OFF state to enable editing of a profile.(see **stopping a program**)

1. Open the **programmer interface**.
2. Select module tab corresponding to required PID module.
3. On toolbar click on **programmer** menu select **new program**.
4. When pointer is in profile chart area right click mouse.
5. Mouse over **add segment** and the following menu should be shown.

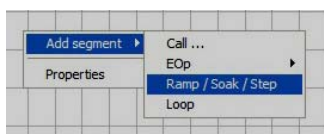

6. To add segments click on **ramp/soak/step**.
7. Enter quantity of segments required then press OK.



8. Click and drag segment points on the **profile chart area** to draw the required profile.
9. Click to open data for each segment in **segment property menu**.

Module 1	Module 2	Module 3
Property Value		
[-] Segment 1 [RAMP]		
Segment type	RAMP	
Ramp rate	600	
Target Setpoint	350	
Holdback band	0	
EDP Status	None	
[-] Segment 2 [SOAK]		
Segment type	SOAK	
Soak time	300	
EDP Status	None	

10. Adjust values for any parameters that require modification. (see section on segment parameters).
11. If you require to add additional segments (ramp/soak/step), call programs, event inputs, event outputs or loops, see notes below.
12. Once the profile is created click on **programmer menu** then click on **write program data**.
13. The program is now written to the controller.

PROGRAM SEGMENT TYPES

Ramps

During a ramp segment the setpoint will change at a user defined rate until a target setpoint is reached.

[-] Segment 1 [RAMP]	
Segment type	RAMP
Ramp rate	50
Target Setpoint	100
Holdback band	10
EDP Status	None

The ramp rate entered is set as process units per hour or minute, refer to section on **program properties** to configure.

If the ramp rate is set too high, setpoint may become much higher (or lower, if cooling) than process value. In this case, the holdback band function will hold the moving setpoint when the process value falls out-with the number of units set in the holdback band. Once the process value increases to fall within the band value, the moving setpoint will resume ramping at the specified rate.

Soaks

During a soak cycle the setpoint will be held constant for a user defined period of time.

[-] Segment 2 [SOAK]	
Segment type	SOAK
Soak time	60
EDP Status	2D

Click **soak time** parameter value box and time is displayed as hh:mm:ss.

Soak time	00:01:00
-----------	----------

Enter soak time required then click on parameter name, the soak time displayed is then displayed as total number of seconds.

At the end of the soak period an event output can be triggered see notes on **Event outputs** below.

Step

A step is an instantaneous change in setpoint. Please note that it can take a process value some time to reach target setpoint after a step function. If a soak function is preceded by a step function, the soak period commences immediately after the setpoint has changed and not when the process value reaches setpoint, this can result in the soak period appearing to be shorter than expected.

[-] Segment 3 [STEP]	
Segment type	STEP
Target Setpoint	200
EDP Status	2D

At the end of the soak period an event output can be triggered, see notes on **Event outputs** below.

Event outputs

SP2 and SP3 output state can be changed at various points of the program using event outputs.

Event outputs can be selected as an individual segment or after other segment types have completed such as ramps, soaks, steps and loop.

Segment 8 [EOP]	
Segment type	EOP
EOP Status	2D

Outputs must be assigned as **event outputs** in **setpoint 2** and/or **setpoint 3 control settings** menu before EOP's can be used. See section on **PID Module settings**.

Once outputs are configured select the correct EOP status for program segment.

- None* No event output.
- 2D* SP2 output de-energised to mark event.
- 2E* SP2 output energised to mark event.
- 3D* SP3 output de-energised to mark event.
- 2E* SP3 output energised to mark event.
- 2D 3D* Both SP2 and SP3 outputs de-energised to mark event.
- 2E 3D* SP2 output energised and SP3 output de-energised to mark the event.
- 2E 3E* Both SP2 and SP3 outputs energised to mark event.
- 2D 3E* SP2 output de-energised and SP3 output energised to mark the event.

Note: Only valid options will be displayed on the menu for selection. If required option is not shown ensure that SP2 and SP3 outputs are configured correctly.

Event outputs are a change of state of SP2 or/and SP3. This state will remain until another event output is used to reverse it or the program is stopped.

Event inputs

When an event input is used, a program is held at that point until a signal to proceed is received via a logic program. When the program is held awaiting an event input, the temperature (or other process value) is held constant until the input is received.

The event input number should be selected to match the event input in the logic program.

Segment 4 [EIP]	
Segment type	EIP
Event Input	2

Call

If the same profile is required as part of a number of programs, it can be saved as a program and called into another program when required. By inserting a **call** segment and choosing the required program the profile section will be added.

Segment 6 [CALL]	
Segment type	CALL
Called program #	1

This will be shown on the profile chart as a shaded section.

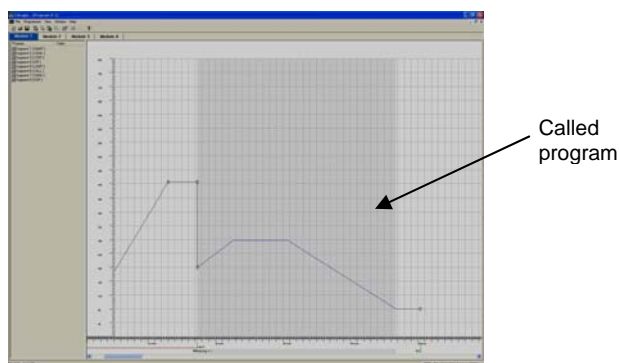

Loop

The loop function will run the same profile a specified number of times (recycle count). E.g. If a program has a recycle count of 5 the profile will run 6 times in total.

Only one loop can be used in a program.

Segment 5 [LOOP]	
Segment type	LOOP
Recycle count	5
EOP Status	2E

Once the number of loops are completed an event output can be triggered, see notes on **Event outputs**.

PROGRAM PROPERTIES

Program properties allows you to set parameters for a program displayed on the **profile chart area**.

When a program is displayed on the user interface click on **properties** in the **programmer** menu.

The **program properties** box should now open

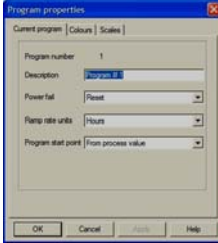

Current program tab

Program Number	Displays the number of the currently open program.
Description	A user defined label (name) can be set as a program name.
Power Fail	After a power failure one of three options can be chosen. Continue – Resume program from last point before failure. Hold – Hold program at current point until manually restarted. Reset – Restart program from beginning.
Ramp rate units	Set ramp rate units as minutes or hours.
Program start point	Start program from process value or set-point.

Colours Tab

The grid, main program profile, sub program profile, background, loop marker, EOP marker and EIP marker colours can be set for the **profile chart area**.



Scales Tab

Scale maximum and **Scale minimum** settings can be set for **profile chart area**.

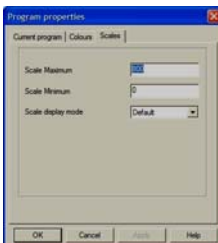

By selecting **full screen** on **scale display mode** the profile scales are resized to fit on screen.

READING PROGRAM DATA FROM A CONTROLLER

(Note that program data is read from the controller when opening the programmer interface. The **read program data** function is used to recover program data that has been modified in the **programmer interface** but not written to the controller.

1. When the **programmer interface** is open click on required module tab.

2. Click on **read program data** in the **programmer** menu.
3. Information from the controller is read and program 1 is displayed on the programmer interface.

CREATING AN ADDITIONAL PROGRAM

1. Follow instructions in section on **creating a program**.

SELECTING A PROGRAM

1. When the **programmer interface** is open click on the required module tab.
2. Click on select program in the programmer menu.
3. Select required program.

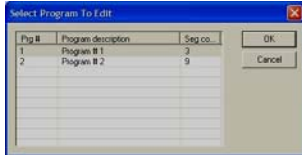

4. The selected program will now be displayed on the program interface.

INSERT SEGMENTS TO A PROGRAM

1. When the **programmer interface** is open click on required module tab.
2. **Select program** required in the **programmer** menu.
3. In the profile chart click to highlight segment point where the additional segments are to be inserted.
4. Right click the mouse in **profile chart area**.
5. Mouse over **insert segment** then click on **ramp/soak/step**.
6. Select the number of segments to insert.
7. Adjust segments to create profile as required. see **creating a program**.
8. **Write program data** in **programmer** menu.

DELETING SEGMENTS

1. In the profile chart, click to highlight the segment node that requires deletion.
2. Right click in the **profile chart area**.
3. Click on **delete segment**.
4. Click **OK** to accept segment delete.
5. The segment is now deleted from the program.

MODIFYING A PROGRAM

1. Open the **programmer interface** and select the tab for required module.
2. Select the program to be modified, see **Selecting a program**.
3. Click and drag chart points to create required profile.
4. **Write program data** in **programmer** menu.

RUNNING PROGRAMS

1. Ensure that programs are written to the controller and **programmer interface** is closed.
2. Right click on controller image.

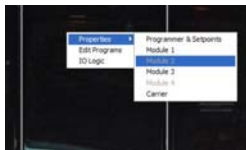

- 3.
4. Mouse-over properties and select **programmer and set-points**.
5. Expand **(+) programmer menu**.

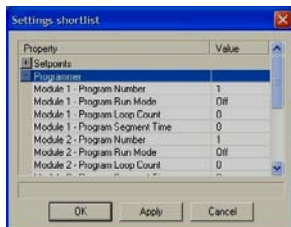

6. Scroll to required module.
7. Enter program number to be run i.e. **Module * - Program Number**.
8. Set program run mode to **on**.
9. **Apply** settings to controller.
10. The selected program will now run.

STOPPING A PROGRAM

1. Right click on controller image.

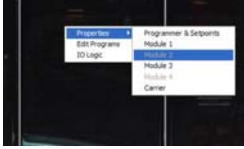

2. Mouse over properties select **programmer and set-points**.
3. Expand (+) **programmer** menu.

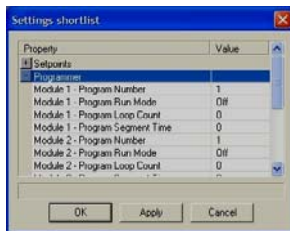

4. Scroll to required module.
5. Set program run mode of required module to **off**.
6. **Apply** settings to controller.
7. The program will now stop.

Logic I/O Module and Logic Programming

OVERVIEW

CALogix has integrated logic function capability that can be used for controlling a system by linking associated inputs and outputs using logic, timer, counter and comparator functions.

A logic programming utility is included within CALogix-sw that can be used to create logic function block diagrams when a CALogix system has logic I/O modules fitted. The logic programming memory will allow programs up to 40 Boolean blocks or up to 16 timers/counters depending on the complexity of the blocks used i.e. some function blocks (e.g. timers) have been developed by using several other function blocks and will therefore require more memory.

LOGIC I/O MODULE SETTINGS

To access logic I/O settings right mouse click on the controller image, mouse over properties then click on the module number (module slot number must have logic I/O module fitted)

The settings window will now open.

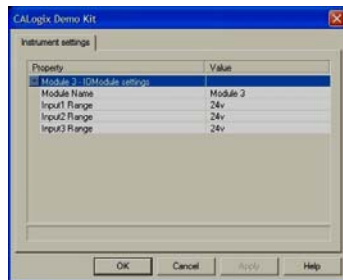

A user-defined label (name) for the module can be entered in the **module name** field, once a label is entered click on the apply button to write the label to the controller. This label will be visible on the controller image in CALogix-sw and will be included when the application is exported to .rtf files. The label can have a maximum of 10 characters

Input 1,2,3 range

The voltage range of inputs 1, 2 and 3 can be user-defined as one of three voltage ranges i.e. 0-24V, 0-10V and 0-5V. These voltages are used to determine high and low states for logic functions and also for comparator switching levels. Voltages above 66% of the input range will be considered as high state and below 33% as low state e.g. for a 0-10V input range <3.3V = low logic state (0) and >6.6V = high logic state (1).

Comparators will convert the input level to a percentage of full scale and will be compared against other inputs or a constant. e.g. With an input range of 0 - 24V, an input voltage of 2.4V will be considered to have a value of 10.0 in a comparator block.

Each of the inputs can be independently set for a different voltage level input. Once each input has been set, write the settings to the controller by clicking the apply button.

LOGIC PROGRAMMING

CREATING LOGIC PROGRAMS

ACCESSING LOGIC PROGRAMMING

- 1) Click  icon on main toolbar
- 2) Logic programming desktop should now open

THE LOGIC TOOL BAR



Create Boolean function block

AND, OR, XOR, LATCH, NAND, NOR, XNOR boolean function block can be created
See section on Boolean function blocks.



Create comparator function block

Compare two I/O module inputs or compare an I/O block input with a constant. 'greater than' or 'less than' comparator options. See section on comparator blocks.



Create timer/counter function block

Select one of eleven timer types or two counter types. See timers/counters overview section.

**Create input function block**

I/O module inputs, power up or output status can be used as logic input function blocks.

**Create output function block**

Function blocks for a switching a physical output, changing setpoint, selecting manual power, starting autotune, event input and running a program can be created.

**Function block linking tool**

Creates a link between two function blocks in a logic program.

**Read logic data from controller**

Existing logic data in desktop is overwritten by logic program read from controller.

**Write logic data to controller**

Logic program is written from desktop to the controller. Logic data is also validated at this time.

**Clear logic data**

Clears logic data on the desktop. Logic programs within the controller are NOT cleared, unless a blank desktop is written to controller.

**Validate logic data**

Logic validation ensures that a logic program is created as a functional program. If function blocks are not used in the correct way or links to inputs or outputs are missing a message will be displayed giving details of the error.

**Logic program trace mode**

Trace mode allows monitoring of a logic program that is running in a controller. Green lines show the active part of the program. Counter and timer values can also be read. **Note:** Windows is not a real-time operating system therefore there may be a delay before changes in the controller are visible on PC screen. If other applications are running in addition to CALogix-sw the delay may be greater.

Note: When in trace mode the logic desktop will be in read-only mode.

**Stop logic program**

The logic program running within the controller are stopped. Note. The 'logic program running' LED on the CALogix base unit will switch OFF.

**Run logic program**

The logic program within the controller memory will run. The 'logic program running' LED on the CALogix base unit will switch ON.

**Align function blocks to left**

Align all highlighted function blocks with the blocks to the left.

**Align function blocks to right**

Align all highlighted function blocks with the blocks to the right

**Align function blocks to top**

Align all highlighted function blocks to the top.

**Align function blocks to bottom**

Align all highlighted function blocks to the bottom.

**Resize function blocks to same width**

Resize all highlighted function blocks to the same width.

**Resize function blocks to same height**

Resize all highlighted function blocks to the same height .



Resize function blocks to same height and same width

Resize all function blocks to the height and width of the blocks to that of the widest and highest blocks.







Apply grid to desktop

Apply grid to the logic desktop to assist with aligning and creating programs.

PLACING A FUNCTION BLOCK ON THE LOGIC DESKTOP

- 1) Left-Click on the icon for the logic function block type you require.
- 2) Continuing to hold the mouse button, drag the mouse pointer into the logic desktop area.
- 3) Once mouse pointer is in position that you want to place function block, release the mouse button.
- 4) The function block should now be visible.

ARRANGING FUNCTION BLOCKS

- 1) Click'n'drag an area encapsulating function blocks
- 2) Function blocks that require rearranging should now be highlighted
- 3) Click on  (left),  (right),  (up) or  (down) icons to arrange function blocks in the required direction.
- 4) The function blocks will now align.

LINKING FUNCTION BLOCKS

- 1) Create required function blocks on logic desktop.
- 2) Click on function block linking tool icon .
- 3) Click and hold left mouse button in the centre of first block .
- 4) Drag mouse pointer to the centre of second function block.
- 5) Release left mouse button.
- 6) The two function blocks should now be linked.
- 7) Repeat from step 2 to link additional function blocks.

Note: All timers have one input, but counters, Boolean and comparators have two. Output blocks have one input. All timers, counters, Boolean, comparators can have multiple outputs. Inputs can connect to multiple timers, counters, Boolean and comparators simultaneously. You cannot link physical outputs to inputs, use Output (In) blocks.

FUNCTION BLOCKS - SELECTING OPERATION

Each type of function block has a number of variations in operation. Once a block has been dropped on the logic desktop right click on the block and select properties.

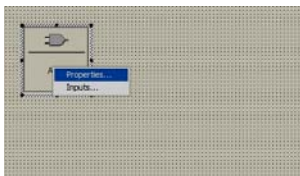

A window will open up with the function block settings window

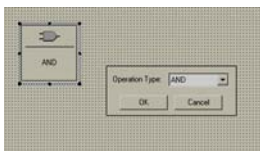

By clicking on the drop down menu for operation type (or mode in some blocks) the operation type can be selected.

The various function block options and how they are configured is shown below.

LOGIC BLOCKS

1. Boolean

Operation mode for a Boolean function block can be selected as AND, NAND, OR, NOR, XOR, XNOR or LATCH (see selecting operation above.). Truth table for Boolean functions are given in truth tables in the **appendix**.

Each Boolean function block requires a two inputs from either an **input block** or other **function blocks**. The output of the block must be connected to another **function block** or an **output block**.

II. Timers

A number of timer functions are available with CALogix, these are: on-delay, off-delay, on-off delay, on-pulse, off-pulse, on-off pulse, delayed-pulse, symmetrical recycler pause, symmetrical recycler pulse, asymmetrical recycler pause and asymmetrical recycler-pulse. Timer charts showing the operation of these are shown in **appendix**



The time settings are entered by clicking on the time required and entering the data in HHH.MM.SS.S format. Once entered click on OK to accept the settings change.

All timers require a single input from either an input block or another function block. The block output must be connected to another **function block** or an **output block**.

Time settings for standard timer types are set via CALogix software. To adjust timer settings remotely via an operator panel, SCADA or field device ensure that the 'remote' box is ticked in the function block 'properties'. This feature is only available for 'on' and 'off' delay timers, other timer types can be created from these basic timer blocks, contact CAL for more information. The data register in which the timer can be accessed remotely is shown outlined in the function block when the logic program has been downloaded to CALogix, see below.



Timer value is stored in register, 2824 (dec)

III. Counters (select timer block)

Counters blocks will give an output after the input has received a user specified number of input pulses. Two types of counter blocks can be selected **counter reset** and **high speed counter**. The high speed counter can count pulses up to 1kHz and counter reset to a frequency of 10Hz. Otherwise both counters function in a similar way.

If using a high speed counter, the physical input for the counter must be from input 1 on the logic I/O module.

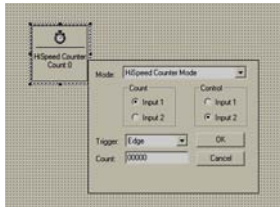

To set a count value, enter the required number in **counts**.

A counter requires two inputs to operate, a count input and a control input. As pulses are received at the count input the counter will increment, an output is given when the set number of counts is received. The counts received will reset to 0 when the control input goes to a high-state (1), the block output is also reset to a low-state (0) if the count value had been previously reached.

The operation of each of the input 1 and 2 can be selected in the properties window shown above.

It is also possible to select whether the counter will increment on a rising **edge** (low to high state) or **level** triggered (i.e. when input reaches and is stable at a high state). This is set within the **trigger** parameter within the properties window.

IV. Comparator

Comparator blocks take a voltage level from a logic I/O module and compare the value with either a constant or the value of another logic I/O module input.

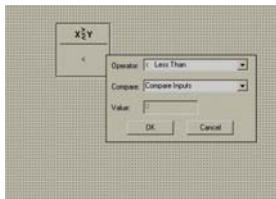

Comparators convert the input level to a percentage of full scale e.g On a logic I/O module input with range of 0 - 24V, an input voltage of 2.4V will be considered to have a value of 10.0 in a comparator block. The compare function allows a greater or a less than comparison with the input. If the comparison is true the block will have a high-state output (1).

The block will require one input for comparing with a constant or two when comparing inputs. The output must be connected to an output or another function block.

Inputs

Inputs blocks provide a link from physical inputs to control logic functions. There are three types of output block

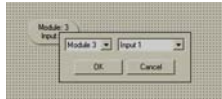

1. Physical Input – The input block status mirrors the current state of a physical input on a logic I/O module.
2. Power Up – The input status is high (1) when the CALogix unit is powered up.
3. Output (In) – The input block status mirrors the output state of a PID or a Logic I/O block.
4. Soft I/P – Soft inputs allow logic to be triggered remotely from an operator panel, SCADA or field device. There are 8 soft inputs (0-7) available within a CALogix base unit and are stored in a single register (1910dec, bits 0-7).

Outputs

Output blocks require a single input from other function blocks or an input block. Do not connect the output of an output block to other function blocks.

I. Physical output

To control output on a logic I/O module a **physical output** block is used. To configure an output block select the module number and the output.

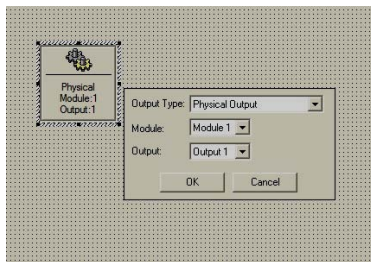

When connected to logic function blocks the specified physical output will switch as the logic driving the output changes state.

II. Changing set-point

Setpoint of a PID module can be changed using an output function block. By entering the required value the setpoint will be changed when switching from low (0) to high (1) logic state.

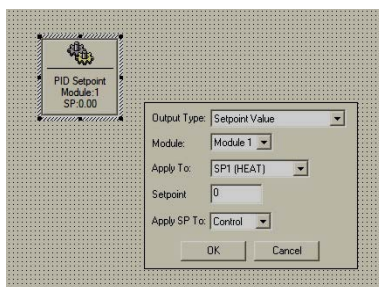

The setpoint change can be selected to apply to SP1, SP2 or SP3 of a specified module.

III. Manual Power

PID control can be suspended and replaced by a constant proportional output by using a manual power function block. The value is entered as a % of full power (i.e. 100% = output fully on).

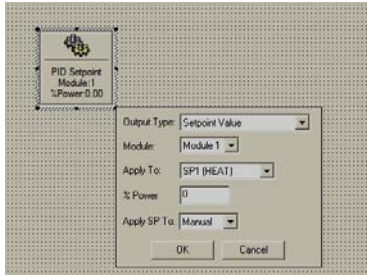

Manual power can be selected to apply to SP1, SP2 or SP3 of a specified module and will operate when input to the block switches from low (0) to high (1) logic state.

To return to PID control from manual power an additional block can be created within the logic program to set manual power value to 0.

IV. **Autotune**

A PID module can be tuned using an output logic block.

Autotune@75%SP (75% setpoint) or **Autotune@ATSP** (at setpoint) can be selected for the required PID module.

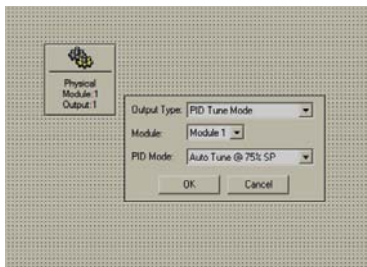

PARK can also be selected to disable the controller outputs. In a situation where **PARK** is activated using a logic function, the controller can only be taken out of **PARK** by changing the mode settings in CALogix-sw or via an operator panel.

V. **Event Input**

Event inputs are set within the programmer functions of CALogix. If required within a program, a profile will be held in its current position until an event input is received.

Select the module number and give the event a numerical tag that corresponds to the required event input.

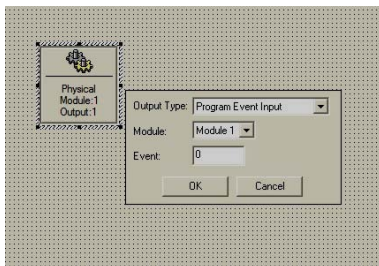

For easy identification it is recommended that you give an event input the same number as the segment in the program. For instance if the EIP segment is 4 then set the event input to number 4 in the logic, This will mean that when the EIP segment is displayed it will appear as EIP4.

VI. **Program**

A **program** output can be used to run, stop or hold a program (profile).

Select the **module** and the **program number** along with the **control mode**.

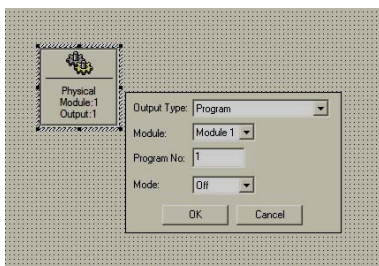

When the input to the block is high (1), the chosen programmer function will be activated.

INVERTING INPUTS

Function block inputs can be inverted in the following way

1. Right-click on function block
2. Click on inputs

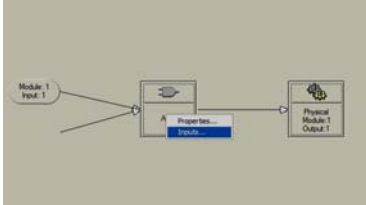

3. Click on **invert** boxes for the inputs that require inverting.

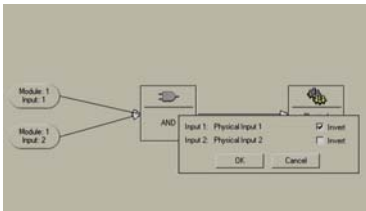

4. Click on OK to accept setting.

VALIDATING A PROGRAM

Once a logic program is complete click on  icon on the logic toolbar. A check is then carried out for program validity and any errors are displayed see example below.

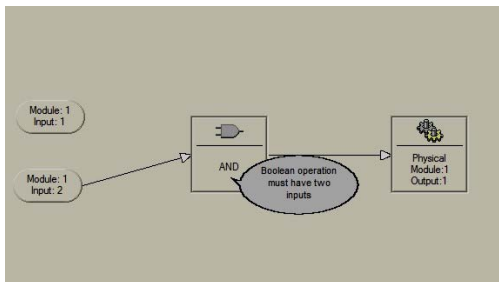

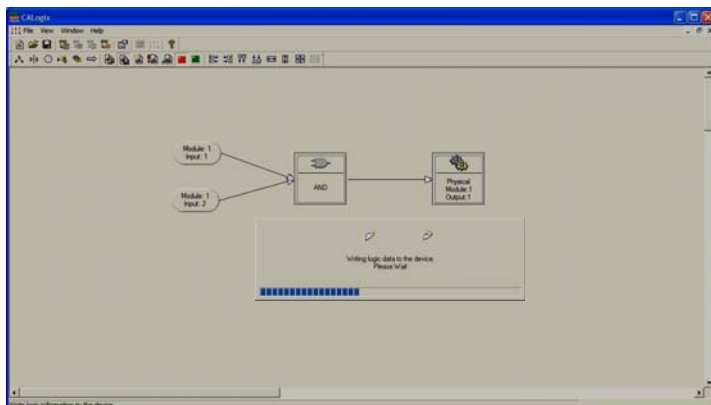

WRITING A PROGRAM TO CONTROLLER

Programs are written to the controller by clicking  on the logic toolbar. Any changes made to the program before writing to the controller are only stored on the **logic desktop**.



As the program is being written to the controller a progress bar is visible.

RUNNING AND STOPPING A LOGIC PROGRAM

Click  on the logic toolbar to start a program that is written to the controller, the Logic running LED on the base unit should be ON when a logic program is running. To stop a logic program running click  on the logic toolbar and the logic running LED should switch off.

TRACE MODE

Trace mode allows a user to monitor a logic program as it is running. After a logic program is started click  on the logic tool bar.

Any active parts of the circuit are highlighted in green

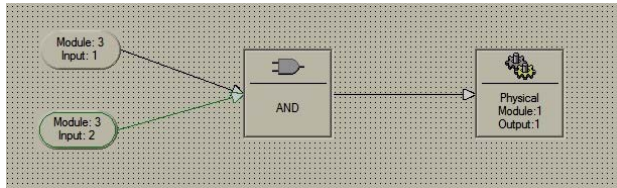

As the output of a function block becomes active (1) a green triangle is shown on the top left corner of the block.

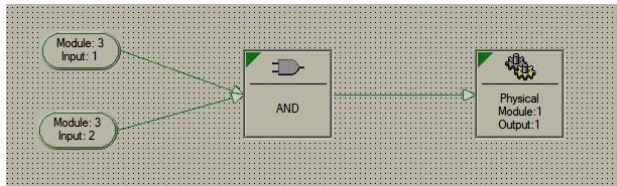

Current timer and counter values are also shown within the logic block and will show changes as they occur.

While trace mode is on the logic desktop will be in read only mode, no changes to the function block can be made.

To exit trace mode click on  .

Note : As windows is not a real time operating system there may be a delay from when an action occurs at the controller to when it is displayed within CALogix-sw. This delay may be reduced by closing down other applications whilst CALogix-sw is running.

APPENDIX Boolean Functions

AND

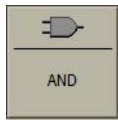

INP1	INP2	OUT
0	0	0
0	1	0
1	0	0
1	1	1

NAND

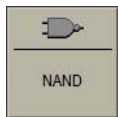

INP1	INP2	OUT
0	0	1
0	1	1
1	0	1
1	1	0

OR

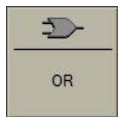

INP1	INP2	OUT
0	0	0
0	1	1
1	0	1
1	1	1

NOR



INP1	INP2	OUT
0	0	1
0	1	0
1	0	0
1	1	0

XOR

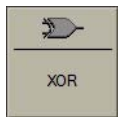

INP1	INP2	OUT
0	0	0
0	1	1
1	0	1
1	1	0

XNOR



INP1	INP2	OUT
0	0	1
0	1	0
1	0	0
1	1	1

LATCH



INP1	INP2	OUT
0	0	Latched
0	1	0
1	0	1
1	1	Latched

Timer Functions

On-Delay Timer

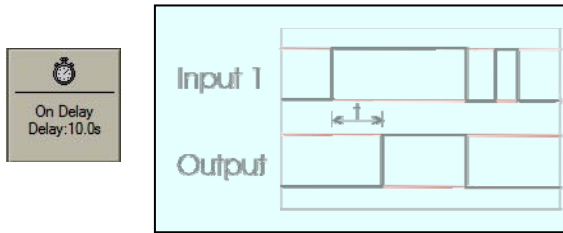

Off-Delay Timer

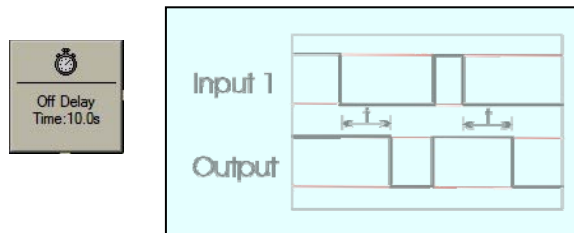

On-Off Delay Timer

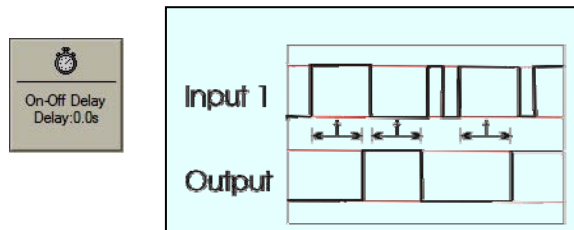

On-Pulse Timer

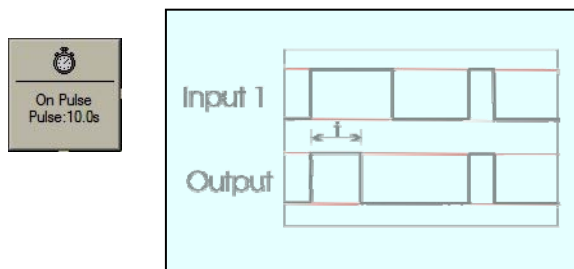

Off Pulse Timer

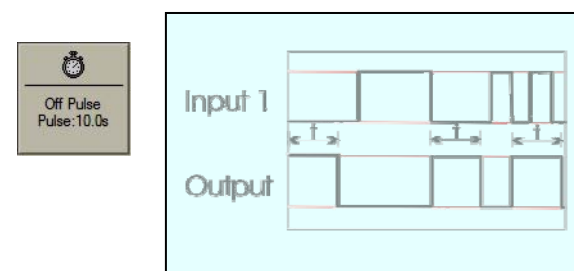

On-Off Pulse

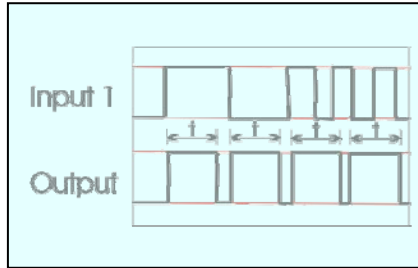

Delayed Pulse

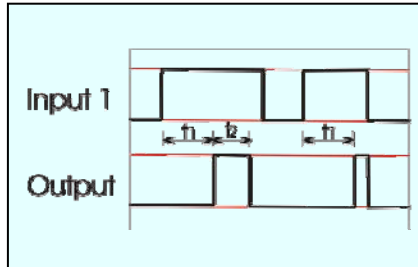
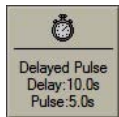

T1 – Delay
T2 – Pulse

Symmetrical Recycler Pause

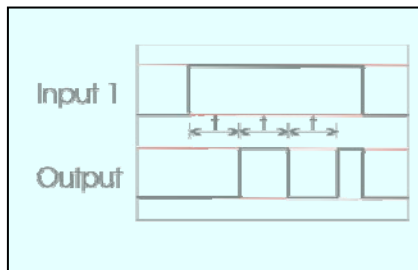

Symmetrical Recycler Pulse

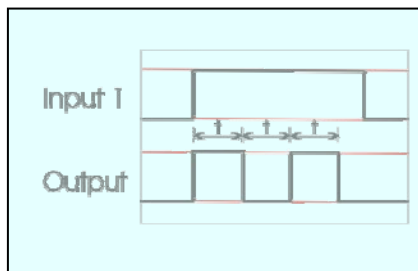
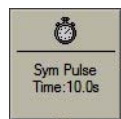

Asymmetrical Recycler Pulse

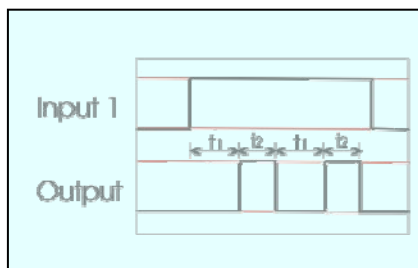
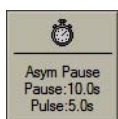

T1 – Pause
T2 – Pulse

Asymmetrical Recycler Pulse

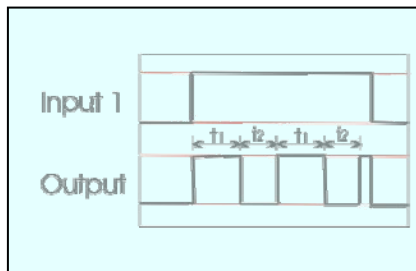
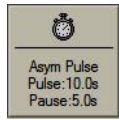

T1 – Pulse
T2 – Pause

Specification

PID MODULE :

THERMOCOUPLE – 9 Types – B, E, J, K, L, N, R, S, T

Standards	IEC 584-1
CJC rejection	30:1 typical
External resistance	100Ω maximum

RESISTANCE THERMOMETER – 2 or 3 Wire

Standards	IEC 751 (100Ω 0°/138.5Ω 100°C Pt)
Bulb Current	0.2mA maximum

LINEAR PROCESS INPUTS

Linear Input	Typical Accuracy	Range
0-50mV	±0.1%	± 0.00 – 99.99, ±100.00 – 499.95, ±500 – 999.9, ±1000 – 9999
4-20mA	±0.1%	As above
0-5V	±0.1%	As above
0-10V	±0.1%	As above

APPLICABLE TO ALL INPUTS (SM = Sensor maximum, FS=Full scale)

Calibration Accuracy	±0.1% FS typical ±1°C
Sampling Frequency	Input 10Hz, CJC 4sec
Common mode rejection	Negligible effect up to 140dB, 240V, 50-60Hz
Temperature coefficient	50ppm/°C SM typical

OUTPUT DEVICES

Solid state relay driver : SSd1 and SSd2	12Vdc +10/-15% 20mA
Miniature power relay: Rly1, Rly2, Rly3	2A/250ac resistive load, form A/SPST
Analogue Output	4-20mA 500Ω max ±0.1% FS typical 0-5Vdc 10mA 500Ω min ±0.1% FS typical 0-10Vdc 10mA 1KΩ min ±0.1% FS typical

LOGIC I/O MODULE :

Input Range	0-5 / 0-10 / 0-24 Vdc (s/w select)
Outputs SSd1 and SSd2	12Vdc +10/-15% 20mA
Rly1, Rly2, Rly3	2A/250ac resistive load, form A/SPST
Maximum counter input frequency	1 fast 1KHz, Other 10Hz
Accuracy	±1%

ENVIRONMENTAL:

Safety	EN61010, UL and CSA approvals pending
Measurement	Categories II and III
Pollution	Degree II
EMC Emission	EN61000-6-3
EMC Immunity	EN61000-6-2
Mouldings	Flame retardant polycarbonate
Weight (including connectors)	Base unit – 170g, 6oz Control module – 90g, 3.2 oz
Ambient*	0 to 55°C
Humidity	90% max non-condensing
Altitude	Up to 2000m

SUPPLY:

Supply voltage	18-30Vdc, 8 watts ±10% fluctuation permitted
----------------	--

Note : As with all electronic devices, product life is reduced at high ambient temperatures. Ensure that your control panel sufficiently cooled to maximise product life.

Safety and Warranty Information

Installation

EN61010-1 / UL61010C-1 / CSA 22.2 No 1010
To offer a minimum of basic insulation only
Suitable for measurement within category II and III and pollution degree 2

See Electrical installation

It is the responsibility of the installing engineer to ensure this equipment is installed as specified in this manual and is in compliance with appropriate wiring regulations.

Configuration

The controller can only be configured using CALogix-sw or CALgrafix software. It is the responsibility of the installing engineer to ensure that the configuration is safe.

Ultimate Safety Alarms

Do not use SP2/SP3 or logic module outputs as the sole alarm where personal injury or damage may be caused by equipment failure.

Warranty

CAL Controls warrant this product free from defect in workmanship and materials for three (3) years from date of purchase.

1. Should the unit malfunction, return it to the factory. If defective it will be repaired or replaced at no charge.
2. There are no user serviceable parts in this unit. The warranty is void if the unit shows evidence of being tampered with or subjected to excessive heat, moisture, corrosion or other misuse.
3. Components which wear or damage with misuse are excluded e.g. relays.
4. CAL Controls shall not be responsible for any damage or losses however caused, which may be experienced as a result of the installation or use of this product.

CAL Controls liability for any breach of this agreement shall not exceed the purchase price paid. E & O.E.

33087/03/0504



CAL Controls

CAL Controls Ltd

Bury Mead Road, Hitchin, Herts, SG5 1RT, UK
Tel +44 (0) 1462 436161
Fax +44 (0) 1462 451801
e-mail sales@cal-controls.co.uk
www.cal-controls.com

CAL Controls Inc

1117 S. Milwaukee Av, Libertyville, IL60048, USA
Tel (847) 680-7080
Fax (847) 816-6852
e-mail sales@cal-controls.com
www.cal-controls.com