

CAL 9900 AUTOTUNE PID TEMPERATURE CONTROLLER INSTALLATION AND OPERATING MANUAL

INSTALLATION

Install the 9900 controller in panel **see 10.2**
Wire up connections **see 10.1**

1 TO SELECT SENSOR AND ADJUST SET POINT

Step 1

POWER UP
Self check sequence



Step 2

ZERO FLASHES ON LEFT
Indicating no sensor selected



Note
Buttons only adjust flashing digits
(shown green)

Step 3

PRESS \blacktriangle TO SELECT
SENSOR e.g. Type K = 2
Sensor options:
(For full table **see 8**)



J	1	R	4	E	7	RTD	9
K	2	S	5	L	8	PT100	
N	3	T	6	B	10		

Step 4

PRESS **P** TO ENTER
SENSOR INTO MEMORY
Display shows process
temperature e.g. Ambient



Step 5

PRESS \star TO DISPLAY
SET POINT



Step 6

PRESS AND HOLD \star
TO INCREASE
SET POINT



Output turns on and temperature rises

The controller is now
operational with
factory PID settings:

Prop band 2.5%
Prop time 20 sec
Derivative 25 sec
Integral 5 min
DAC approach
control 1.5

2 IMPORTANT - Please read before using Autotune AT

- 1 If required adjust: Range, Hi-res 0.1°, Negative temperature ranging, **see 8**
- 2 Proportional cycle-time: 20 sec factory set, if unsuitable change now or use Autotune calculated value after tuning run **see 6**
- 3 For best results use normal set point and load conditions
- 4 Start Autotune AT with the load cool

TO AUTOTUNE

Step 7

START AUTOTUNE 'AT'
NEAR AMBIENT

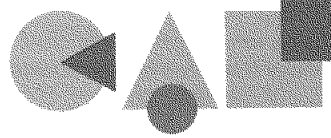

CAL Controls

The CAL 9900 microprocessor based temperature controller provides precise control with a minimum of setting up, the advanced Autotune algorithm tunes all five control parameters automatically. The simple setting up procedure below is normally sufficient, specialised applications may need the comprehensive 9900 features covered in this manual.

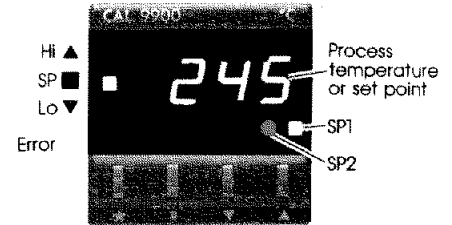

- \star View set point
- \blacktriangledown Decrease
- \blacktriangle Increase

KEY CONTENTS GUIDE

- 9 Important caution - please read first
- 10 Installation 1 Setting up
- 2, 3, 5 Autotune 6 Prop cycle-time
- Functions 4 Selection 8 Table
- 7 Alarms 11 Error messages

Step 8

PRESS **P** TO ACCESS
PROGRAM MODE
Function O flashes
on right



Step 9

PRESS \star TO CHANGE
TO OPTION SELECTION
Option O flashes
on left

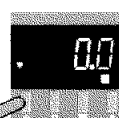

Step 10

PRESS \blacktriangle TO SELECT
AUTOTUNE 'AT'
Option 1

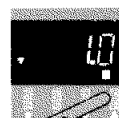

Step 11

PRESS **P** TO START
AUTOTUNE 'AT'



AT and Process
temperature displayed
alternately during
Autotune



Autotuned parameters Autotune limits

Entered automatically:
Proportional band/Gain 0.5 - 20.0 c/range
Integral time/Reset 0.2 - 43.5 min
Derivative time/Rate 1.0 - 255 sec
DAC approach control 0.5 - 9.0 x gain

Proportional cycle time 0.8 - 819 sec

Calculated but for safety reasons needs
manual acceptance **see 6**

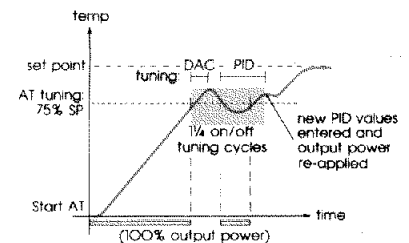

Fig. 1 Autotune AT

3.2 AUTOTUNE PT (Push-to-Tune) Select Opt 2 at step 10

Used to fine tune difficult applications at set point. Useful if the set point or thermal conditions are substantially changed. During PT tuning some overshoot will occur. If this is unacceptable, temporarily reduce set point. PT tunes the parameters listed above except DAC. Proportional cycle time is re-calculated but needs manual acceptance

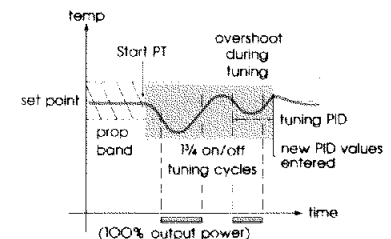

Fig. 2 Autotune PT

3.3 OVERRIDING AUTOTUNE VALUES

After AT/PT any Autotuned parameter may be changed to an Option from the table. The original Autotuned value is retained in memory. Note Subsequent Autotune AT or PT run replaces manual selections with new calculated values (except Cycle time)

3 AUTOTUNE TYPES AND USES

Two types of Autotune are provided to ensure optimum control of a wide range of applications

AUTOTUNE AT - Normal method, tunes during warm up

AUTOTUNE PT - (Push-to-Tune) - For difficult applications, tunes at set point

3.1 AUTOTUNE AT

Start Autotune AT with the load cool. A short tuning cycle occurs at 75% set point during warm up. New PID values are automatically entered and the temperature rises to set point

4 CONTROLLER FUNCTIONS DISPLAY AND SELECTION PROCEDURE

The facilities of the 9900 are selected from the Functions and Options Table **see 8** using program mode
Functions (Fn) – The available controller facilities
Options (Opt) – The available values for each Function e.g. Function 5 Option 0 (Fn 5/Opt 0) = SP1 Prop band of 2.5%
Note 1 Should difficulty occur in adjusting Options check the Parameter lock **see 14**
Note 2 Normal control is maintained with existing settings during programming

4.1 Step 1

PRESS **P** TO ENTER PROGRAM MODE

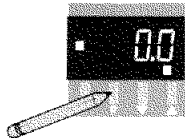

Step 2

PRESS AND HOLD **▲** INDEX TO FUNCTION e.g. Function 16 (Sensor select) flashes



Step 3

PRESS ***** CHANGE TO OPTION SELECTION e.g. Option 2 (Type K)

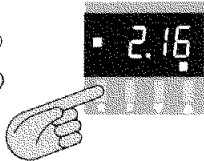

Step 4

PRESS **▼** or **▲** SELECT OPTION REQUIRED e.g. Option 1 (Type J)

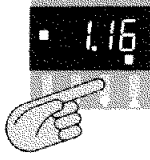

Step 5

PRESS ***** CHANGE TO FUNCTION SELECTION Set other Functions as required

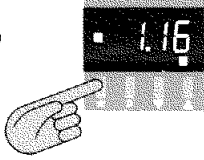

Step 6

PRESS **P** TO EXIT PROGRAM MODE WHEN SELECTIONS COMPLETE Process temperature displayed

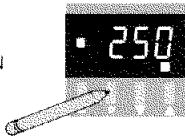

Control commences with new instructions now entered in memory

4.2 MODE B – FUNCTION/OPTION DISPLAY PROCEDURE

Used in Function 2 to set full scale alarms and Function 24 – Range adjustment Mode B enables all digits to be used for Options values

Step 1

PRESS **▲** TO INDEX TO FUNCTION e.g. Function 24 (Range adjustment) flashes Note 2 bars = Mode B



Step 2

PRESS ***** TO DISPLAY OPTION VALUE e.g. Range 400° flashes

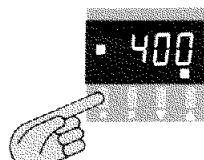

Step 3

PRESS AND HOLD ***** PRESS **▲** TO INCREASE
 PRESS **▼** TO DECREASE OPTION VALUE

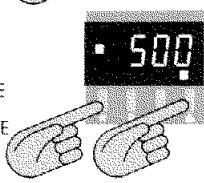

5 AUTOTUNE HINTS

5.1 Autotune error messages **see 11** (EE5-7)

(Latched: PRESS **▼▲** to reset) AT/PT tunes most applications satisfactorily, but if tuning fails and error messages repeatedly occur, the application has unusual characteristics requiring manual tuning **see 21**

5.2 Tuning with set point near ambient

Difficult both to control and Autotune. Use PT. If tuning fails try with Fn 5/Opt 1, otherwise increase set point or tune manually

5.3 In High Resolution (0.1°)

Should error message EE6 occur during tuning, select normal resolution (Fn 18/Opt 0) then Autotune and afterwards re-select Hi-res. (check range setting Fn 24)

5.4 AUTOTUNE VALUE DISPLAY

At the end of an Autotune run the AT value is automatically entered and may be displayed in Functions:

- 5 Prop band/Gain
- 6 Derivative time/Rate
- 7 DAC approach control
- 8 Integral time/Reset

Step 1

PRESS **P** TO ENTER PROGRAM MODE

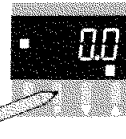

Step 2

PRESS **▲** TO INDEX TO FUNCTION e.g. Function 5 Prop band AT value = 3.5%



Note 3 LED's show an AT value displayed

6 PROPORTIONAL CYCLE TIME

6.1 Autotuned cycle time

Autotune calculates the optimum value but for safety reasons does not automatically implement it

6.2 If the cycle time needed is known

Applications known to require shorter times than the 20 sec factory setting, including SSR drive (1 sec), linear outputs (0.05 sec) should select the appropriate Option in Function 4 using the procedure **see 4**. This setting will not be changed, but may be replaced with the calculated AT value if preferred after the Autotune run

6.3 Normal procedure

Run Autotune AT **see 2**. When complete (alternating AT display stops) display the AT calculated cycle time and accept if suitable, this will then replace the 20 sec factory setting

Step 1

Index to Function 4 For procedure **see 4** Option 0: 20 sec factory setting



Step 2

PRESS ***** TO CHANGE TO OPTION SELECTION

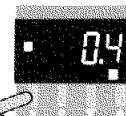

Step 3

PRESS **▲** TO DISPLAY CALCULATED AT VALUE e.g. 9.8 sec Note Flashing bar shows calculated AT value is displayed



Step 4

IF AT VALUE SUITABLE

PRESS **P** TO ACCEPT AT VALUE NOW OPERATIONAL

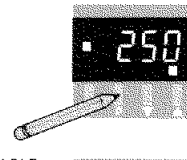

OR IF AT VALUE UNSUITABLE

PRESS **▲** TO SELECT A SUITABLE OPTION FROM TABLE e.g. Option 4: 30 sec



6.4 AT Cycle time values in Function 4

Two AT cycle time values are stored, to enable the current operational value to be retained, until a new value from a subsequent Autotune run is considered Example of two AT cycle time values after a subsequent Autotune run:

Step 5

Index to Function 4 Operational AT value – 9.8 sec As accepted previously (Step 4) Note 3 LED's ON

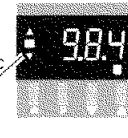

Step 6

PRESS ***** TO CHANGE TO OPTION SELECTION

Step 7

PRESS **▲** TO DISPLAY Latest calculated AT value e.g. 7.2 sec Note Flashing bar



Step 8

Alternative actions:

PRESS **P** to accept the latest calculated AT value – 7.2 sec which replaces 9.8 sec as the operational AT value

OR PRESS **▼** to display current operational AT value. Then PRESS **P** to retain 9.8 secs

OR PRESS **▲** to select Option from Table

7 ALARMS

7.1 SP2 Operating mode

The operating mode must be selected at Function 19 before adjusting SP2 at Function 2

7.2 Alarm output operation

The alarm output is failsafe, SP2 relay is de-energised and SP2 red LED on during the alarm condition (Not with SP2 in Proportional mode)

7.3 LBA – Loop break alarm **see Fig. 3**

LBA detects a control loop fault, and displays an error message (EE3). The alarm relay may be configured to act also LBA operates if the controller fails to receive the correct response to the output within a set time, technically: LBA occurs when SP1 output is saturated 0% or 100% and the process temperature fails to move a minimum 50% prop band in the LBA time. SP1 output state is unaffected by LBA alarm condition

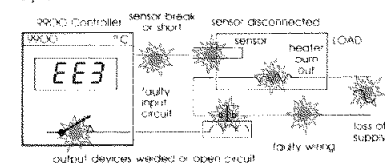

Fig. 3 Typical faults detected by LBA

7.4 Selecting LBA – EE3 message only

1. Index to Function 12 – LBA time Option 0 – LBA OUT, displayed

2. PRESS ***** to change to option selection

3. PRESS **▼** to select Option 14 The recommended initial setting (2 x Integral time in use)

4. LBA alarm condition: EE3 displayed, alternating with process temperature display latches, to reset PRESS **▼▲** together To configure Alarm relay SP2 to LBA Select Option 6 in Function 19 (Relay latches in alarm condition, to reset PRESS **▼▲**) Note Use LBA with SP2 ON/OFF mode only (Fn 10/Opt 0). Reset EE3/Relay before any other program changes

8 FUNCTIONS AND OPTIONS TABLE
Please read these important notes first

- Factory setting:** is Option O (except Functions 2 and 22)
- Initial configuration:** Functions 16-24 must be selected first then entered into memory by exiting Program mode - see 4 then Autotune and other Functions may be selected

- Protected Functions:** All Functions, except User Settings (Functions 1, 2, 3) may be locked in memory after setting to prevent tampering. See 14 Parameter lock
- AT values** (marked \blacktriangle): As calculated on the latest AT or PT run

- Locating Functions:** Function O is the Program mode entry point
Pressing \blacktriangle increments
 \blacktriangledown moves direct to Function 13 for access to higher Functions
Hold pressed to auto index through table (Functions 13, 14, 25 are unused)

Fn Opt No. No. Parameter
OPERATING MODE ... Protected

- O Operating mode**
- O Normal Operation**
- 1 Start Autotune AT
2 Start Autotune PT
3 Park mode
4-100 Manual heat %

USER SETTINGS ... Unprotected

- 1 Manual Reset (OUT IN PID)**
1° steps (max $\pm 127^\circ$ / 50% prop band)
- 2 SP2 Adjust**
1° steps Factory setting 5°
SP2 mode must be selected in Function 19 before adjusting SP2
- | | | |
|------------------|------------|------------------|
| SP2 mode (Fn 19) | Option No. | Function 2 range |
| Deviation alarm | 1-3 | O - 127° |
| Full scale alarm | 4-5 | O - * |
| Cool strategy | 7 | $\pm 127^\circ$ |
- (* Sensor range : Fn 16)

- 3 SPI Lock**
- O Unlocked**
1 Locked

OPERATIONAL PARAMETERS ... Protected

- 4 SPI Proportional cycle time**
- | | |
|-------------------|--|
| O 20 sec | 10 3 sec |
| 1 1 sec | 11 7 sec |
| 2 5 sec | 12 14 sec |
| 3 10 sec | 13 45 sec |
| 4 30 sec | |
| 5 60 sec | |
| 6 0.05 sec | 14 \blacktriangle Operational AT value |
| 7 ON/OFF | 15 \blacksquare Latest calculated AT value |
| 8 0.3 sec | |
| 9 2 sec | |

- 5 SPI Proportional band/Gain**
- | | |
|------------------|--------------|
| O 2.5% CR | 1.25% |
| 1 0.5% | 0.25% |
| 2 1% | 0.5% |
| 3 2% | 1% |
| 4 3% | 1.5% |
| 5 5% | 2.5% |
| 6 10% | 5% |
| 7 20% | 10% |
| 8 1.5% | 0.75% |
| 9 4% | 2% |
| 10 6% | 3% |
| 11 7% | 3.5% |
| 12 8% | 4% |
| 13 14% | 7% |
| 14 100% | 50% |
- 15 \blacktriangle AT value**

- 6 SPI Derivative time/Rate**
- | | |
|------------------|--|
| O 25 sec | 9 3 sec |
| 1 OUT | 10 7 sec |
| 2 5 sec | 11 15 sec |
| 3 10 sec | 12 20 sec |
| 4 50 sec | 13 35 sec |
| 5 100 sec | 14 75 sec |
| 6 200 sec | |
| 7 1 sec | 15 \blacktriangle AT value |
| 8 2 sec | |

Fn Opt No. No. Parameter
OPERATIONAL PARAMETERS ... continued

- 7 SPI DAC approach control**
- | | |
|--------------------------|---|
| O 1.5 x prop band | 5 3.0 |
| 1 0.5 | 6 4.0 |
| 2 1.0 | |
| 3 2.0 | 7 \blacksquare AT value |
| 4 2.5 | |

- 8 SPI Integral time**
- | | |
|------------------|--|
| O 5 min | 8 0.2 min |
| 1 OUT | 9 7 min |
| 2 0.5 min | 10 13 min |
| 3 1 min | 11 25 min |
| 4 2 min | 12 33 min |
| 5 3 min | 13 43 min |
| 6 10 min | |
| 7 18 min | 14 \blacktriangle AT value |

- 9 Sensor error correction**
1° steps ($\pm 127^\circ$ max)

- 10 SP2 Proportional cycle time**
- | | |
|-------------------|--|
| O ON/OFF | 9 3 sec |
| 1 1 sec | 10 7 sec |
| 2 5 sec | 11 14 sec |
| 3 10 sec | 12 45 sec |
| 4 20 sec | Non linear ranges for Cool strategy |
| 5 60 sec | 13 0.15-10 sec |
| 6 0.05 sec | 14 0.15-20 sec |
| 7 30 sec | 15 0.06-15 sec |
| 8 2 sec | |

- 11 SP2 Proportional band/Gain**
- | | |
|------------------|--------------|
| O 2.5% CR | 1.25% |
| 1 0.5% | 0.25% |
| 2 1% | 0.5% |
| 3 2% | 1% |
| 4 3% | 1.5% |
| 5 5% | 2.5% |
| 6 10% | 5% |
| 7 20% | 10% |
| 8 1.5% | 0.75% |
| 9 4% | 2% |
| 10 6% | 3% |
| 11 7% | 3.5% |
| 12 8% | 4% |
| 13 14% | 7% |
| 14 100% | 50% |

- 12 LBA ... Loop break alarm - time**
- | | |
|-----------------|---|
| O OUT | 9 30 min |
| 1 1 min | 10 40 min |
| 2 2 min | 11 50 min |
| 3 4 min | 12 70 min |
| 4 6 min | 13 90 min |
| 5 8 min | Recommended initial setting: |
| 6 10 min | 14 2 x Operational Integral time |
| 7 15 min | |
| 8 20 min | |

- 15 Reset Functions O - 24 to factory settings**
- O Normal**
1 Reset (Function 22 not reset)

Abbreviations:
Fn - Function
Opt - Option
SR - Sensor range
CR - Configured range

Fn Opt No. No. Parameter
INITIAL CONFIGURATION ... Protected

- 16 Sensor Select and Range Table**

		Range Table			
Type		Factory set	Sensor range (SR)		
T/C		°C	°F	°C	°F
1	J	400	800	800	1470
2	K	400	800	1200	1999
3	N	400	800	1200	1999
4	R	1600	1999	1600	1999
5	S	1600	1999	1600	1999
6	T	250	500	250	500
7	E	500	1000	600	1100
8	L	400	800	800	1470
10	B	1600	1999	1800	1999

- RTD**
- 9 PT100 200 400 400 750**
- Range minimum:** 0°C/32°F
Except T/PT100:
Factory set 0°C/32°F
Minimum available -200°C/°F

Linear process inputs	Display
11 O - 20mV	O - 100
12 4 - 20mV	O - 100
13 O - 20mV	O - 1000
14 4 - 20mV	O - 1000
15 O - 20mV	O - 2000

- 17 Negative temperature ranging**
- O Disabled**
1 Enabled (range min -200°)

- 18 Display resolution**
- O Normal (1°)**
1 Hi-res (0.1°) $\pm 199.9^\circ$
1° settings become 0.1°
Ranged O - 200° on selection of Hi-res. (reset with Fn 24)

- 19 SP2 Operating mode**
Select and enter Function 19 before adjusting SP2 in Function 2
- O OUT**
1 Deviation alarm - High
2 Deviation alarm - Low
3 Deviation band alarm
4 Full scale alarm - High
5 Full scale alarm - Low
6 LBA - Loop break alarm
7 Cool strategy

- 20 SPI Sensor break**
- O Upscale**
1 Downscale

- 21 SP2 Sensor break**
- O Upscale**
1 Downscale

- 22 °C/°F (Note Change top fascia)**
- O °C** { Factory set
1 °F { not reset by Function 15

- 23 Software version number**

- 24 Configured range (CR) adjustment**
- 1° steps
Mode B adjustment see 4.2
(See Range Table in Function 16)

13 IMPORTANT: ADVANCED FUNCTIONS SECURITY

The advanced functions are intended for OEM's and process engineers. Access is therefore protected in the Function table

To avoid unauthorised use of these functions remove this section from the manual before supply to end user

13.1 'HIDDEN' ACCESS TO ADVANCED FUNCTIONS

Step 1

PRESS **P** TO ENTER PROGRAM MODE

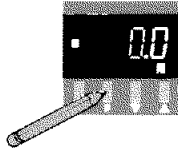

Step 2

PRESS **▼** TO GO DIRECTLY TO FUNCTION 13

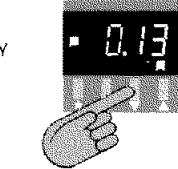

Step 3

PRESS & HOLD ***** FOR 5 sec TO ACCESS ADVANCED FUNCTIONS (Entry point Fn 38)

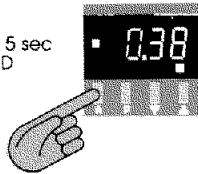

13.2 ADVANCED FUNCTIONS ... Protected

Fn Opt Parameter
No. No.

26 SP1 Heat Power limit

0	100% max	8	60%
1	95% output	9	55%
2	90%	10	50%
3	85%	11	45%
4	80%	12	40%
5	75%	13	30%
6	70%	14	20%
7	65%	15	10%

Not in SP1 ON/OFF mode

27 SP2 Cool limit

0	100% max	4	40%
1	80% output	5	30%
2	60%	6	20%
3	50%	7	10%

Not in SP2 ON/OFF mode

Direct/Reverse mode selection

	Normal	OFF when logically ON
28 SP1 Output	<input type="radio"/>	1
29 SP1 LED	<input type="radio"/>	1
30 SP2 Output	<input type="radio"/>	1
31 SP2 LED	<input type="radio"/>	1

32 Error indicator resolution

0	Normal (2% range/segment)
1	High (1%)
2	Low (4%)

33 Temperature display sensitivity

0	Normal
1	High
2	Low

34 Derivative polling ratio

0	0.5 x derivative time
1	0.2
2	0.7
3	1.0

35 Sensor span adjust

1% steps (+15°/-16° max)

Note 'Hidden' Fn 15/Opt 5 resets ALL functions, except Fn 22

36 SP2 Latch alarms

- 0 Normal
- 1 Latch

Only for: SP2 ON/OFF mode, Fn 19/Opt 1-5

PRESS **▼▲** together to reset (in non alarm condition)

37 Spare

DIAGNOSTICS

Read only Functions 39-49 Mode B display **see 4.2**

PERFORMANCE MONITOR (PM)

38 Start monitor (Entry point from Fn 13)

- 0 OFF
- 1 Start

Readings are reset on subsequent monitor start or de-powering

39 Read temperature variance (0.1°)

40 Read maximum temperature (°C/°F)

41 Read minimum temperature (°C/°F)

42 Read Duty Cycle Monitor (DCM) % heat (SP1 % ON time)

AUTOTUNE TUNING DATA Fig. 8

Overshoot/Undershoot (°C/°F)
Max 255°/Hi-res 25.5°

- | | |
|--------|-------|
| 43 OS1 | 45 US |
| 44 OS2 | |

Quarter cycle times (sec)

Min 2 sec/max 1800 sec (30 min)

- | | |
|---------------------------------|---------|
| 46 QCT1 | 48 QCT3 |
| 47 QCT2 | 49 QCT4 |
| 50 Spare PRESS ▲ to Fn 0 | |

13.3 DIAGNOSTICS Functions 38 - 49

To assist with machine development, commissioning and trouble shooting

PERFORMANCE MONITOR (PM)

Monitors and displays minimum and maximum temperatures, and variance (deviation) to 0.1°C/°F. Displayed temperatures are measured values, independent of set point. This high sensitivity monitor may be affected by interference. (Fit snubber to minimise disturbance)

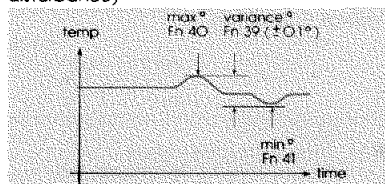

Fig. 7 Performance monitor (PM) Fns 38-41

DUTY CYCLE MONITOR (DCM)

Monitors percentage power used in the previous proportioning cycle. Average several readings for a more accurate result. Power requirements outside the range 20% - 80% may be difficult to control and autotune

AUTOTUNE TUNING DATA (Fns 43-49)

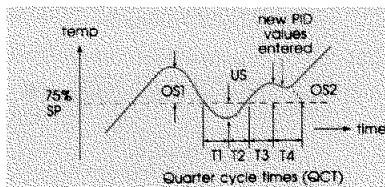

Fig. 8

13.4 MONITOR OPERATION (PM/DCM)

Step	Select
1 To start monitor:	Fri 38/Opt 1
2 To return to normal operation	PRESS P
3 To view readings (PM/DCM)	Fns 39-42
4 To stop monitor: (Readings are retained)	Fri 38/Opt 0
5 Reset	Fri 38/Opt 1
Readings reset on next monitor start.	
Monitor and readings reset	On de-powering

14 PROGRAM SECURITY LOCK

To be made by qualified technician. De-power controller before proceeding using a screw driver at side of bezel remove lower fascia containing push buttons. All functions except user settings - Functions 1-3 can be protected against tampering. To protect function settings change the plastic link from unlocked to locked position.

- LOCKED (or remove link)
- UNLOCKED

15 INTERNAL LINK CHANGES

These operational modifications should be made by a qualified technician before installation.

To remove the 9900A board:

1. First remove the output module, carefully lever the retaining clips from the slots in the module cover with a small screwdriver.

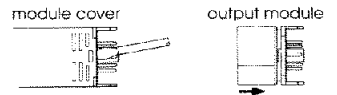

2. Tap module cover on table top, as shown, to release the 9900A board. Carefully remove board, avoid damaging components on protruding tongue

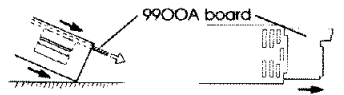

15.1 To convert to 3 wire RTD/PT100

(inhibits thermocouple operation) Carefully cut pad at X avoid damage to R3. Fit solder links LK1, LK2 using 22SWG wire.

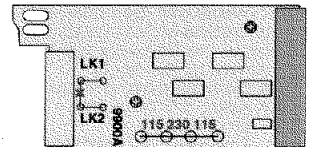

15.2 Supply Voltage Conversion (Plug in links)

IMPORTANT - check your installation operating voltage before proceeding. Wrongful conversion could damage this unit.

For 115 Volt ±15% operation fit two links (spare link in accessories bag) in positions 115 and 115. For 230 Volt ±15% operation fit one link in position 230.

16

9900 FUNCTION/OPTION RECORD

Customer Ref:	
9900	model serial no.
Function Number	Option Set
	date:

17 COOL STRATEGY FOR HEAT-COOL APPLICATIONS

Cool strategy: A change in load causes movement of the linked heat and cool prop bands

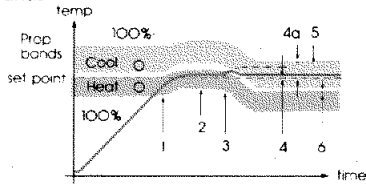

Fig. 9

1. Integral causes linked prop bands to move up
2. Stabilises e.g. 30% heat
3. Exothermic load change causes integral to move prop bands down minimising disturbance
4. Minimum offset achieved (4a = offset without cool strategy integral action)
5. Stabilises e.g. 50% cool
6. Consistent dead band throughout

17.1 SETTING UP ROUTINE FOR HEAT COOL (Single zone procedure)

Step 1:

1. **Run Autotune AT:** (Set normal operating temp) Accept AT proportional cycle time **Fn 4/Opt 15**
Note SP1/SP2 cycle times must be compatible with switching devices used (SP2 cool output is OFF at this stage)
2. **When temperature stable at set point:**
 - Select **cool strategy** **Fn 19/Opt 7**
 - Select **cool prop band** option value from table nearest to Heat prop band value (view **Fn 5**) **Fn 11**
 - Select **cool cycle time** option value nearest to Heat cycle time value (view **Fn 4**) **Fn 10**
 - Adjust SP2 dead band to 0° (Factory set 5°) **Fn 2**
3. **Run with normal background/exothermic thermal conditions,** good results should be achieved and provide the basis for fine tuning
4. **Further adjustments:** e.g. Water cooling. Should oscillation occur try (in order):
 - Double **cool prop band** value **Fn 11** and reduce integral time value **Fn 8**
 - Halve **cool cycle time** **Fn 10**
 - Introduce **cool overlap** **Fn 2/(-)ve**
5. **Non-linear cooling**
For water cooling above 100°C where flash to steam occurs. Select non-linear ranges in **cool cycle time** **Fn 10/Opt 13-15**
6. **Fine tuning**
If **overshoot** (into cool) or **undershoot** (into heat) occurs, slowly make the following adjustments, observing the results:
 - Increase **cool overlap** **Fn 2/(-)ve**
 - Apply SP2 **cool limit**, progressively **Fn 27/Opt 1**
If needed: SP1 **heat limit** **Fn 26/Opt 1**
7. **Contact CAL for more application advice and data if required**

18 NOTES ON OTHER FUNCTIONS

Function Item

- Fn 0 Park mode** (Opt 3)
Temporarily turns outputs off
Display: and Process temperature
Useful in commissioning and trouble shooting, e.g. Multizone applications
Manual heat % (Opt 4-100)
If sensor break occurs (EE1/2) SP1 output (heater power) may be manually controlled 4-100% (Not in ON/OFF mode)
Display: XXH (XX = % output)
- Fn 3 SP1 Set point lock**
Stops unauthorised adjustment
- Fn 5 Retransmission:**
With 100% prop band, accuracy ±5% configuration range using linear input/output

19 RECALIBRATING TO A REMOTE STANDARD

To enable the 9900 calibration to match an external meter, data logger etc. (i.e. 'Remote' reading)

SENSOR ERROR CORRECTION: Fn 9

Provides correction at one single temperature

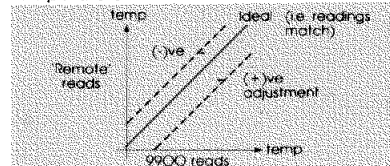

Example Reads
9900 404°
'Remote' 400°

Error +4° Set (-4) correction at Fn 9
Note Error polarity applies to 9900 correction

Sensor span adjust: Fn 35

Provides correction where two temperatures require differing amounts of adjustment

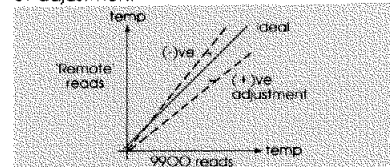

1. Choose a temperature towards the bottom of the normal operating range and one at the top
2. Run at the lower temperature T1, note the error E1 between 9900 and 'Remote' reading
3. Repeat at upper temperature T2 and note error E2

Example T1 reads 60° T2 reads 200°
9900 60° 200°
'Remote' 58° 205°
Error E1 = +2° E2 = -5°

4. Calculation of span adjustment for Fn 35

Formula: $Fn\ 35 = \frac{E2 - E1}{T2 - T1} \times CR$ (as **Fn 24**)

Example: $Fn\ 35 = \frac{(-5^\circ) - (+2^\circ)}{200^\circ - 60^\circ} \times 250^\circ$
 $= \frac{-3}{140} \times 250$

Fn 35 = -5° Set (-5°) in **Fn 35**

5. A span error entered in **Fn 35** immediately changes the reading, allow time to stabilise at T2, if an error exists correct with **Fn 9**. Then check at T1, if an error exists check readings and calculations; repeat if necessary

20 PID TUNING NOTES

1. **Proportional cycle time: Fns 4/10**
Determines the cycle rate of the output device

Output device

9900 Internal relays
SSR
Linear output (mA/Vdc)

Recommended time

10 sec minimum (5 sec with derated contacts & snubber)
1 sec
0.05 sec



Ideal

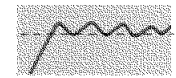

Too long (oscillates)

2. **Proportional band/Gain: Fn 5/11**
Smooths out oscillation occurring in ON/OFF control

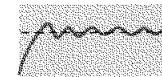

Too narrow (oscillates)

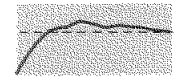

Too wide (slow warm up and response)

3. **Integral time/Reset: Fn 8**
Automatically corrects offset errors caused by proportional control

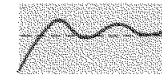

Too short (overshoots and oscillates)



Too long (slow warm up and response)

4. **Derivative time/Rate: Fn 6**
Suppresses overshoot and speeds response to disturbances

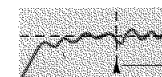

Too long (oscillates and over corrects)



Too short (slow warm up and response under disturbance)

5. **DAC approach control: Fn 7**
Tunes warm up characteristics independent of normal operating conditions. Controls when derivative action starts on warm up. (smaller setting = closer to set point) Useful when sensor very remote from heater



Too small (overshoot)



Too large (slow stepped warm up)

21 PID MANUAL TUNING GUIDE

For unusual applications producing error messages (EE5/6) on Autotune AT/PT

1. **Initial settings:**

Fn 5/Opt 0
(or Reset functions: **Fn 15/Opt 1**)
Fn 4/Opt 7 (ON/OFF Mode)
Normal operating set point
(Then allow process to stabilise)

2. **Take several readings of:**

Amplitude A

Time period T

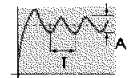

(Diagnostics Fns 38/39 may help)

3. **Set PID values:**

Fn	Parameter	Value	Set opt value
Fn 4	Prop cycle time (Ensure compatible with output device)	T / 20	Nearest

Fn 5	Prop band/Gain	A x 1.5 x 100%	Next larger
------	----------------	----------------	-------------

Fn 6	Derivative time/Rate	T / 10	Next shorter
------	----------------------	--------	--------------

Fn 8	Integral time/Reset	T / 60	Next longer
------	---------------------	--------	-------------

Fn 7	DAC Approach control	1.5 factory set	see 20.5
------	----------------------	-----------------	----------



Designed for use: UL 873 - only in products where the acceptability is determined by Underwriters laboratories Inc.
 EN61010-1-Within Installation Categories II and III environment and pollution degree 2.
 To avoid possible hazards accessible conductive parts of final installation should be protectively earthed in accordance with EN61010 for Class 1 equipment.
 Output wiring should be within a grounded cabinet. Sensor sheaths should be bonded to ground or not be accessible.
 Live parts should not be accessible without use of a tool.

It is the responsibility of the installation engineer to ensure that this equipment's compliance to EN61010 is not impaired when fitted to the final installation and to use this equipment as specified in this manual, failure to do so may impair the protection provided. Follow wiring diagrams and regulations.

10 INSTALLATION

10.1 ELECTRICAL INSTALLATION



CAUTION RISK OF ELECTRICAL SHOCK.

1. Check controller label is the correct supply voltage for your application.
2. Connections are shown on the socket label.
3. For connection to socket use .250 Faston receptacles provided in accessory kit.
4. Recommended wire size for mains voltage and outputs 32/0.2 1.0mm² (18 AWG 0.04") rated to 6 Amps/300V at 70°C.
5. For use with 2 wire RTD an external link is required between connections 3 and 5.
6. IMPORTANT. It is recommended that interference suppressors are fitted across relay contacts to prolong relay life.

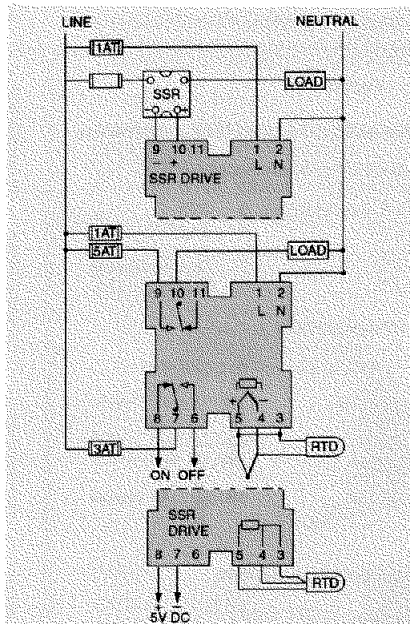

Fuses: 250VAC rated, time lag type to IEC 127.

11 ERROR MESSAGES

APPLICATION FAULTS

EE1 Sensor burnout	Check sensor	Self clearing
EE2 RTD/PT100 short	Check sensor	Self clearing
EE3 LBA Loop break	Check control loop	Latches: Reset

AUTOTUNE AT/PT TUNING CYCLE FAULTS

Autotune run is aborted:
 Previous values are retained

EE5 Outside time limit	Latches: Reset
EE6 O/shoot exceeds limit	Latches: Reset
EE7 Unable to run Autotune	Latches: Reset SP1 in ON/OFF mode

SOFTWARE FAULTS

EE8 Calibration data error	Replace unit if it persists
EE9 System error	Replace unit

PRESS ▼▲ together to reset latched message

WARRANTY

CAL Controls warrant this product free of defects in workmanship and materials for three (3) years from date of purchase

1. Should the unit malfunction, return it to the factory. If defective it will be repaired or replaced at no charge.
2. There are no user-serviceable parts in this unit. This warranty is void if the unit shows evidence of being tampered with or subjected to excessive heat, moisture, corrosion or other misuse.
3. Components which wear, or damage with misuse, are excluded e.g. Relays, SSR.
4. To comply with this warranty the installation and use must be by suitably qualified personnel.
5. Neither CAL Controls Ltd or CAL Controls Inc shall be responsible for any damage or loss to other equipment howsoever caused, which may be experienced as a result of the installation or use of this product. CAL Controls liability for any breach of this agreement shall not exceed the purchase price paid.

12 9900 SPECIFICATION

INPUTS

See 8 Function 16 for Range Table
Thermocouple - 9 types

J Iron/Constantan	T Copper/Con
K Chromel/Alumel	R Pt - 13% Rh/Pt
L Fe/Konst	S Pt - 10% Rh/Pt
N NiCroSil/NiSil	B Pt - 30% Rh/
E Chromel/Con	Pt - 6% Rh

Standards: 1PTS 68/DIN 43710
 Linearity: 5 - 95% sensor range **see 8**
 J/K/L/N/E ±1°C, T ±2°C, B ±6°C >500°C
 R/S O-300°C ±5°C, 300-1600°C ±2°C
 CJC Rejection: 20:1 (0.05%/°C) typical
 External resistance: 100 Ω maximum

Resistance thermometers

RTD/PT100 2 wire (optional 3 wire)
 DIN 43760 100 Ω °C/138.5 Ω 100 °C Pt

Linear process inputs: 0-20mV/4-20mV
 Linearity: ±1.5% Impedance 100k Ω min

Applicable to all inputs

SR=sensor range, CR=configured range
 Calibration accuracy: ±0.25% SR ±1°C
 Sampling frequency: Input 3Hz, CJC 5sec
 Common mode rejection: Negligible effect up to 140dB, 240V, 50-60Hz
 Series mode rejection: 60dB, 50-60Hz
 Temperature coefficient: 150ppm/°C SR
 Reference conditions: 22°C ±2°C, 115/230V ±5%, after 30m settling time

OUTPUTS

OUTPUT MODULE - Dual standard

Main output: SP1
 Relay standard: 5A/250Vac resistive SPDT/Form C
 Ssd-optional: 5V/25mA non-isolated

Alarm/Cool channel output: SP2
 Relay-standard: 3A/250Vac resistive SPDT/Form C
 Ssd-optional: 5V/25mA non-isolated

9900 Controller output module - types

SP1 output	SP2	115V code	230V
Relay	Relay	991.11C/F	991.12C/F
Relay	Ssd	991.21C/F	991.22C/F
Ssd	Relay	992.11C/F	992.12C/F
Ssd	Ssd	992.21C/F	992.22C/F
Relay	-	991.01C/F	991.02C/F
Ssd	-	992.01C/F	992.02C/F

1. CONFIGURATION

All functions are front key selectable, it is the responsibility of the installing engineer to ensure that the configuration is safe. Remove the function lock link to protect critical functions from tampering.

2. ULTIMATE SAFETY ALARMS

Normal safety advice: Do not use SP2 as the sole alarm where personal injury or damage may be caused by equipment failure.

10.2 MECHANICAL

1. Prepare a 1/16 DIN panel cut out: 45 x 45mm +0.6 -0 1.77" x 1.77" +0.02 -0
2. Remove the socket, pressing in the lock buttons
3. Slide the controller into the cut out
4. Fit the mounting clip see fig, pressing it firmly against the panel, jacking screws optional
5. Plug on the socket
6. After installation remove and discard the protective front window label
7. Cleaning - if required wipe with damp cloth (water only)

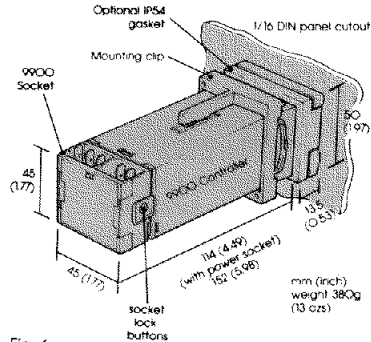

Fig. 6

CONTROL CHARACTERISTICS

SPI PID Parameters	Field selectable
Prop band/Gain	0.5-100% CR
Prop cycle-time	0.05-81s or ON/OFF
Integral time/Reset	0.2-43m or OUT
Derivative time/Rate	1.0-255s or OUT
DAC approach control (ON/OFF Hysteresis)	0.5-9.0 x PB 0.25-50%CR

GENERAL

Supply Voltage: 115V or 230V ±15%
 50-60Hz 6VA (Link selectable)
 Digital LED Display: 3½ digit 10mm high. High brightness green, 3 step LED.
 Error indicator: SP1 Green SP2 Amber.
 Output LEDs: 4 Elastomeric Buttons.
 Keypad:

ENVIRONMENTAL

Humidity: Max. 80%
 Altitude: Up to 2000M
 Installation: Categories II and III Degree II
 Pollution: UL873, CSA 22.2/142-87, EN61010
 Safety: FCC Rules 15 Sub-part J Class A
 Protection: IP54 (with gasket)
 EMC Emission: EN50081-1
 EMC Immunity: EN50082-1, RF Field ±2% FS
 Ambient: 0.50°C (32-130°F)
 Mouldings: Flame Retardant Polycarbonate

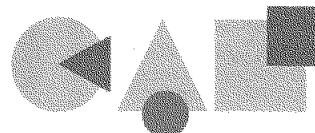

CAL Controls Ltd

Bury Mead Road, Hitchin, Herts, SG5 1RT, UK
 Tel: +44 (0) 1462-436161 Fax: +44 (0) 1462-451801

CAL Controls Inc

1580 S. Milwaukee Avenue, Libertyville, IL 60048
 Tel: (847) 680-7080 Fax: (847) 816-6852

CAL Controls policy of continuous development, may cause detail changes to the enclosed information. E & OE